





Direct-acting 2-way standard solenoid control valve

- Excellent range
- Very good response
- Compact valve design
- Orifice sizes 0.05...2.0 mm
- Port connection 1/8" or sub-base



Product variants described in the data sheet may differ from the product presentation and description.

Can be combined with

	Type 8605 PWM control electronics for electromagnetic proportional valves	▶
	Type 2507 Cable plug, form B according to industry standard	▶
	Type 8611 eCONTROL - Universal controller	▶

Type description

The direct-acting solenoid control valve Type 2871 is used as the regulating unit in control loops. Due to an elastomeric seat seal the valve closes tight (integrated shut-off function), up to the DN specific nominal pressure. The plunger of the valve is assembled frictionless, which leads to an extraordinary adjustment characteristic. This valve is particularly suitable for demanding control tasks (high control range, dry gases, etc.).

DTS 1000173853 EN Version: U Status: RL (released | freigegeben | validé) printed: 25.10.2023

Table of contents

1. General technical data	3
2. Circuit functions	3
3. Approvals and conformities	4
3.1. General notes	4
3.2. Conformity	4
3.3. Standards.....	4
3.4. North America (USA/Canada)	4
3.5. Foods and beverages/Hygiene	4
4. Materials	4
4.1. Bürkert resistApp	4
5. Dimensions	5
5.1. Threaded version	5
5.2. Sub-base version for DN up to 0.4 mm	6
5.3. Sub-base version for DN from 0.6 mm	7
6. Performance specifications	8
6.1. Flow characteristic	8
Determination of the K_v value	8
6.2. Exemplary characteristic curve of a proportional valve	8
7. Product operation	9
7.1. Control unit	9
8. Ordering information	9
8.1. Bürkert eShop	9
8.2. Recommendation regarding product selection.....	9
8.3. Bürkert product filter	9
8.4. Bürkert Product Enquiry Form	9
8.5. Ordering chart	10
Standard version	10
Version with approvals	11
Version for higher differential pressures.....	12
8.6. Ordering chart accessories.....	13
Cable plug Type 2507, form B according to industry standard	13
Control electronics Type 8605 for proportional valves	13

1. General technical data

Product properties	
Dimensions	Further information can be found in chapter "5. Dimensions" on page 5.
Material	
Body	Brass, stainless steel
Seal	FKM, EPDM
Performance data	
Typical values of positioning behaviour ^{1.)}	
Hysteresis	< 5 %
Repeat accuracy	< 0.25 % of end value ^{2.)}
Response sensitivity	< 0.25 % of end value ^{2.)} < 0.1 % of end value ^{2.)} with DN < 0.8 mm
Setting range	1:200: DN 0.8...2 1:500: DN 0.05...0.6
Actuating time (10...90 %)	< 15 ms
Pressure range ^{3.)}	0...12 bar (also applicable for technical vacuum)
Nominal operating mode	100 % continuous operation
Electrical data	
Operating voltage	24 V DC (12 V on request)
Power consumption	Max. 5 W
Maximum coil current ^{4.)}	220 mA (at 5 W and 24 V coil)
PWM frequency ^{5.)}	1500 Hz
Medium data	
Operating medium	Neutral gases, liquids on request
Medium temperature	- 10 °C...+90 °C (with FKM) - 30 °C...+90 °C (with EPDM)
Viscosity	Max. 21 mm ² /s (21 cSt)
Process/Port connection & communication	
Port connection size	Sub-base, G 1/8, NPT 1/8
Electrical connection	Cable plug Type 2507, form B according to industry standard Further information can be found in chapter "Cable plug Type 2507, form B according to industry standard" on page 13.
Approvals and conformities	
Degree of protection	IP65
Environment and installation	
Installation position	As required, preferably with actuator upright
Ambient temperature	Max. +55 °C

- 1.) Characteristic data of control behaviour depends on process conditions.
- 2.) By flow measurement
- 3.) Pressure data: overpressure to atmospheric pressure, depending on nominal diameter, tightness seal or nominal pressure
- 4.) Maximum value: value depends on operating pressure
- 5.) PWM: pulse width modulation

2. Circuit functions

Symbol	Description
	Circuit function A (CF A) 2/2-way solenoid proportional control valve Direct-acting Normally closed

DTS 1000173853 EN Version: U Status: RL (released | freigegeben | validé) printed: 25.10.2023

3. Approvals and conformities

3.1. General notes

- The approvals and conformities listed below must be stated when making enquiries. This is the only way to ensure that the product complies with all required specifications.
- Not all available versions can be supplied with the below mentioned approvals or conformities.

3.2. Conformity

In accordance with the Declaration of conformity, the product is compliant with the EU Directives.

3.3. Standards

The applied standards which are used to demonstrate compliance with the EU Directives are listed in the EU-Type Examination Certificate and/or the EU Declaration of Conformity.

3.4. North America (USA/Canada)

Approval	Description
	Optional: UL Recognized for the USA The products are UL Recognized for the USA according to: <ul style="list-style-type: none"> • UL 429 (Electrically operated valves)

3.5. Foods and beverages/Hygiene

Conformity	Description
USP	United States Pharmacopeial Convention (USP) (valid for the variable code PL04) All wetted materials are biocompatible according to the manufacturer’s declaration.
FDA	FDA – Code of Federal Regulations (valid for the variable code PL02, PL03) All wetted materials are compliant with the Code of Federal Regulations published by the FDA (Food and Drug Administration, USA) according to the manufacturer’s declaration.
	EC Regulation 1935/2004 of the European Parliament and of the Council (valid for the variable code PL01, PL02) All wetted materials are compliant with EC Regulation 1935/2004/EC according to the manufacturer’s declaration.

4. Materials

4.1. Bürkert resistApp

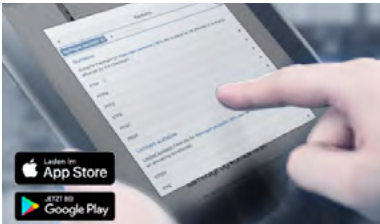

Bürkert resistApp – Chemical resistance chart

You want to ensure the reliability and durability of the materials in your individual application case? Verify your combination of media and materials on our website or in our resistApp.

Start chemical resistance check

DTS 1000173853 EN Version: U Status: RL (released | freigegeben | validé) printed: 25.10.2023

5. Dimensions

5.1. Threaded version

Note:

Dimensions in mm

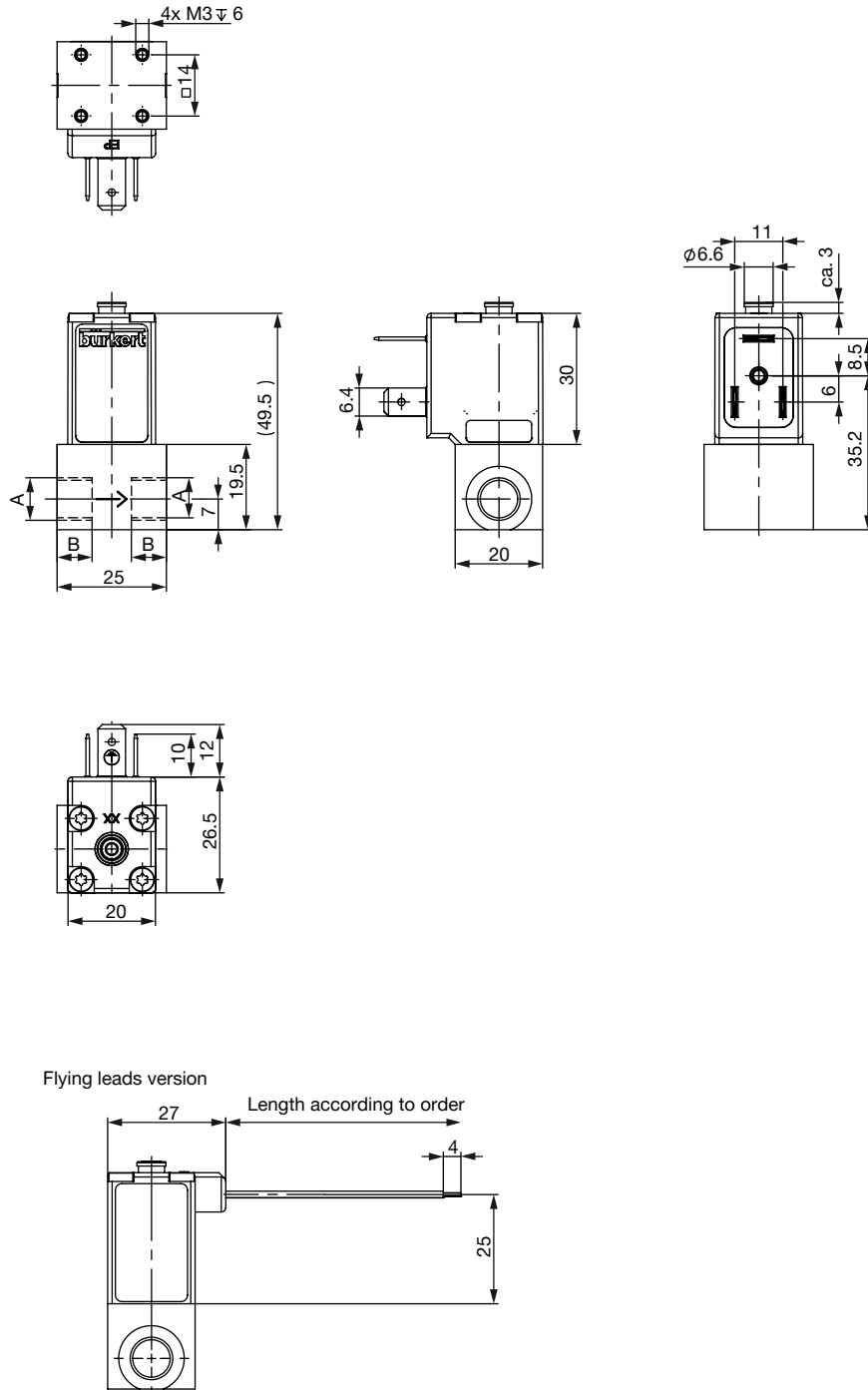

Port connection	A	B
Thread	G 1/8	8
	NPT 1/8	7

5.2. Sub-base version for DN up to 0.4 mm

Note:
Dimensions in mm

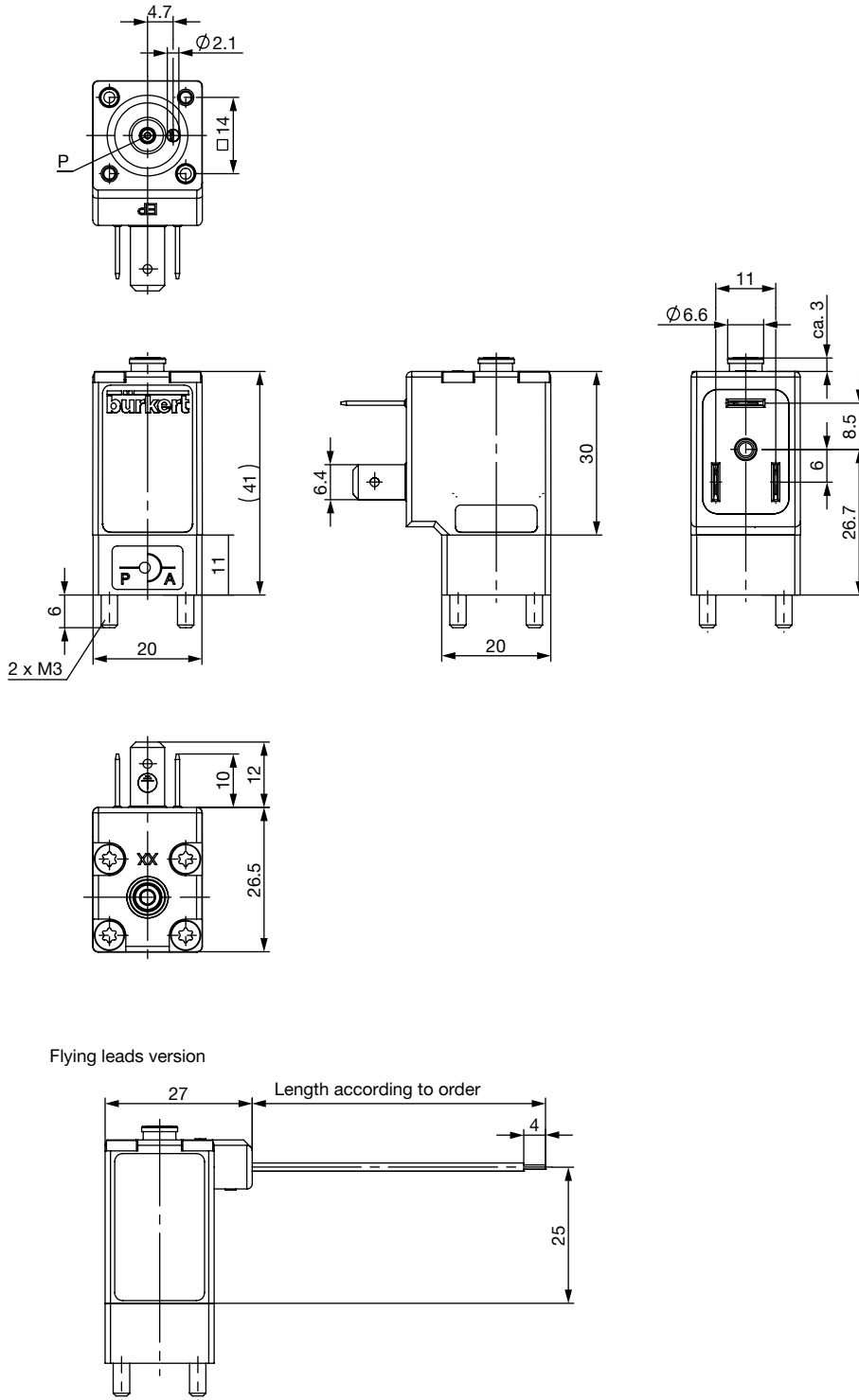

5.3. Sub-base version for DN from 0.6 mm

Note:
Dimensions in mm

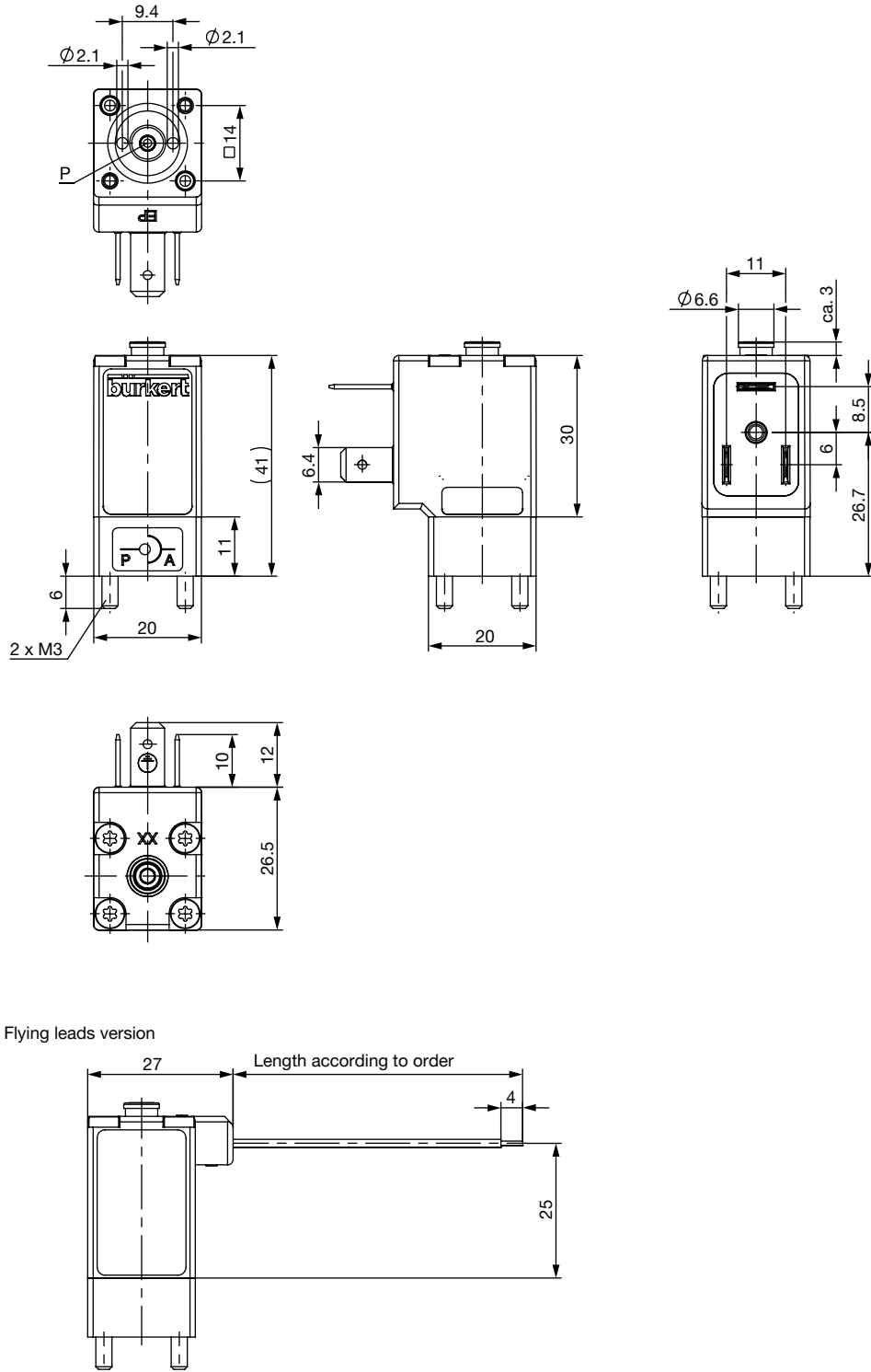

6. Performance specifications

6.1. Flow characteristic

Determination of the K_v value

Pressure drop	K_v value for liquids [m ³ /h]	K_v value for gases [m ³ /h]
Sub-critical $p_2 > \frac{p_1}{2}$	$= Q \sqrt{\frac{\rho}{1000 \Delta p}}$	$= \frac{Q_N}{514} \sqrt{\frac{T_1 \rho_N}{p_2 \Delta p}}$
Supercritical $p_2 < \frac{p_1}{2}$	$= Q \sqrt{\frac{\rho}{1000 \Delta p}}$	$= \frac{Q_N}{257 p_1} \sqrt{T_1 \rho_N}$

- K_v Flow coefficient [m³/h]^{1,3}
- Q_N Standard flow rate [m³/h]^{2,3}
- p_1 Inlet pressure [bar]^{3,3}
- p_2 Outlet pressure [bar]^{3,3}
- Δp Differential pressure p_1, \dots, p_2 [bar]
- ρ Density [kg/m³]
- ρ_N Standard density [kg/m³]
- T_1 Medium temperature [(273+t)K]

- 1.) Measured for water, $\Delta p = 1$ bar, over the valve
- 2.) At reference conditions 1.013 bar and 0 °C (273 K)
- 3.) Absolute pressure

6.2. Exemplary characteristic curve of a proportional valve

Note:

In continuous flow applications, the choice of an appropriate valve size is much more important than with on/off valves. The optimum size should be selected such that the resulting flow in the system is not unnecessarily reduced by the valve. However, a sufficient part of the pressure drop should be taken across the valve even when it is fully opened.

Reference value: $\Delta p_{\text{valve}} > 25\%$ of the total pressure drop

Otherwise, an ideal, linear valve characteristic is deformed into a curved system characteristic.

If the differential pressure (difference between inlet and outlet pressure) exceeds half the value of the nominal pressure discontinuities may occur.

For that reason take advantage of Bürkert competent engineering services during the planning phase.

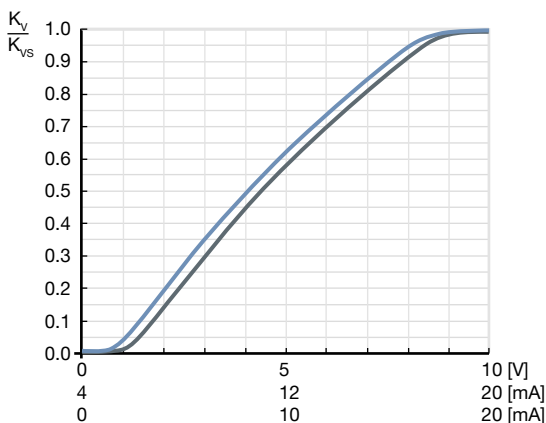

7. Product operation

7.1. Control unit

Valve control takes place through a PWM signal (pulse-width modulation). The duty cycle of the PWM signal determines the coil current and hence the position of the plunger.

The Bürkert control electronics Type 8605 (see data sheet **Type 8605** ▶) converts an analogue signal to a reference value corresponding to the valve type PWM signal and provides additional functions such as temperature compensation (coil heating), ramp function and the adjustment of min. and max. duty cycle/coil current for the control range.

Please note the sizing comments for such a control valve in chapter **“6.2. Exemplary characteristic curve of a proportional valve”** on page 8.

8. Ordering information

8.1. Bürkert eShop



Bürkert eShop – Easy ordering and quick delivery

You want to find your desired Bürkert product or spare part quickly and order directly? Our online shop is available for you 24/7. Sign up and enjoy all the benefits.

[Order online now](#)

8.2. Recommendation regarding product selection

Note:

- Use the product enquiry form (see **“8.4. Bürkert Product Enquiry Form”** on page 9) for information about the device layout and send it to us after completion.
- Please note the chapter **“6.2. Exemplary characteristic curve of a proportional valve”** on page 8 on product selection.

8.3. Bürkert product filter

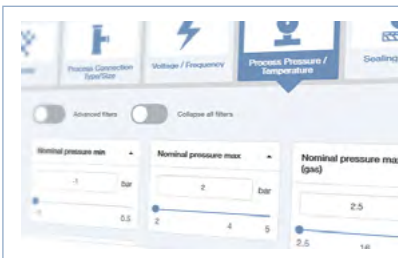

Bürkert product filter – Get quickly to the right product

You want to select products comfortably based on your technical requirements? Use the Bürkert product filter and find suitable articles for your application quickly and easily.

[Try out our product filter](#)

8.4. Bürkert Product Enquiry Form

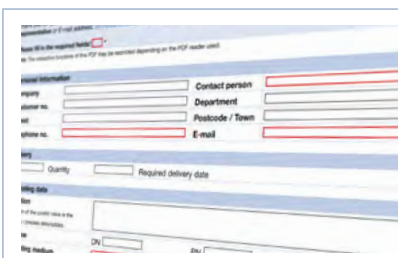

Bürkert Product Enquiry Form – Your enquiry quickly and compactly

Would you like to make a specific product enquiry based on your technical requirements? Use our Product Enquiry Form for this purpose. There you will find all the relevant information for your Bürkert contact. This will enable us to provide you with the best possible advice.

[Fill out the form now](#)

8.5. Ordering chart

Standard version

Note:

- All valves with FKM seal
- DN 0.05 and DN 0.1 with PCTFE seat seal
- Please note that the cable plug must be ordered separately, see **“Cable plug Type 2507, form B according to industry standard”** on [page 13](#) or separate data sheet for **Type 2507** ▶.

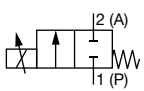
Circuit function	Port connection	Orifice	K _{vs} -value water ^{1.)}	Nominal pressure ^{2.)}	Maximum differential pressure	Article no. Brass body	Article no. Stainless steel body
		[mm]	[m ³ /h]	[bar]	[bar]		
CF A 2/2-way solenoid proportional control valve Direct-acting Normally closed 	Sub-base FK01	0.05	0.00006	10	10	254985	254986
	G 1/8		0.00006	10	10	254443	254444
	NPT 1/8		0.00006	10	10	254968	254971
	Sub-base FK01	0.1	0.00025	10	10	254987	254988
	G 1/8		0.00025	10	10	254446	254447
	NPT 1/8		0.00025	10	10	254972	254973
	Sub-base FK01	0.2	0.001	10	10	254989	254990
	G 1/8		0.001	10	10	254448	254450
	NPT 1/8		0.001	10	10	254974	254975
	Sub-base FK01	0.3	0.002	10	10	254991	254992
	G 1/8		0.002	10	10	254451	254452
	NPT 1/8		0.002	10	10	254977	254978
	Sub-base FK01	0.4	0.004	8	8	254993	254994
	G 1/8		0.004	8	8	254453	254454
	NPT 1/8		0.004	8	8	254979	254980
	Sub-base FK01	0.6	0.01	6	6	254995	254996
	G 1/8		0.01	6	6	254455	254457
	NPT 1/8		0.01	6	6	254981	254982
	Sub-base FK01	0.8	0.018	12	6	235992	235993
	G 1/8		0.018	12	6	235994	235995
	NPT 1/8		0.018	12	6	235996	235997
	Sub-base FK01	1.0	0.027	10	5	235998	235999
	G 1/8		0.027	10	5	236000	236001
	NPT 1/8		0.027	10	5	236002	236003
	Sub-base FK01	1.2	0.038	8	4	236004	236260
	G 1/8		0.038	8	4	236261	236262
	NPT 1/8		0.038	8	4	236263	236264
	Sub-base FK01	1.6	0.055	6	3	236265	236266
	G 1/8		0.055	6	3	236267	236268
	NPT 1/8		0.055	6	3	236269	236270
Sub-base FK01	2.0	0.090	3	1.5	236271	236272	
G 1/8		0.090	3	1.5	236273	236274	
NPT 1/8		0.090	3	1.5	236275	236276	

1.) Measurement at +20 °C, 1 bar pressure differential over a fully opened valve.

2.) Pressure data: overpressure to atmospheric pressure. If the differential pressure between the inlet and outlet pressure of the valve is greater than half of the nominal pressure, discontinuities in the valve characteristic curve are possible.

DTS 1000173853 EN Version: U Status: RL (released | freigegeben | valide) printed: 25.10.2023

Version with approvals

Note:

- All valves with FKM seal
- DN 0.05 and DN 0.1 with PCTFE seat seal
- Please note that the cable plug must be ordered separately, see [“Cable plug Type 2507, form B according to industry standard” on page 13](#) or separate data sheet for **Type 2507** ▶.
- Refer to chapter [“3. Approvals and conformities” on page 4](#) for more information about the approvals.

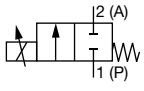
Circuit function	Port connection ^{1.)}	Orifice	Approvals	K _{vS} -value water	Nominal pressure ^{2.)}	Maximum differential pressure	Article no. Brass body	Article no. Stainless steel body
		[mm]		[m ³ /h]	[bar]	[bar]		
CF A 2/2-way solenoid proportional control valve Direct-acting Normally closed 	G 1/8	0.05	UR	0.00006	10	10	274900	274904
	NPT 1/8			0.00006	10	10	274901	274905
	G 1/8	0.1	UR	0.00025	10	10	274902	274906
	NPT 1/8			0.00025	10	10	274903	274907
	G 1/8	0.2	UR	0.001	10	10	274908	274926
	NPT 1/8			0.001	10	10	274909	274927
	G 1/8	0.3	UR	0.002	10	10	274910	274928
	NPT 1/8			0.002	10	10	274911	274929
	G 1/8	0.4	UR	0.004	8	8	274912	274930
	NPT 1/8			0.004	8	8	274913	274931
	G 1/8	0.6	UR	0.01	6	6	274914	274932
	NPT 1/8			0.01	6	6	274915	274933
	G 1/8	0.8	UR	0.018	12	6	274916	274934
	NPT 1/8			0.018	12	6	274917	274935
	G 1/8	1.0	UR	0.027	10	5	274918	274936
	NPT 1/8			0.027	10	5	274919	274937
	G 1/8	1.2	UR	0.038	8	4	274920	274938
	NPT 1/8			0.038	8	4	274921	274939
	G 1/8	1.6	UR	0.055	6	3	274922	274940
	NPT 1/8			0.055	6	3	274923	274941
G 1/8	2.0	UR	0.090	3	1.5	274924	274942	
NPT 1/8			0.090	3	1.5	274925	274943	

1.) Port connection: others on request





DTS 1000173853 EN Version: U Status: RL (released | freigegeben | valide) printed: 25.10.2023

Version for higher differential pressures

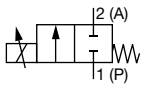
Note:

- All valves with FKM seal
- Other connection variants (Sub-base, NPT) on request
- PWM frequency: 1000 Hz
- Span: 1:100
- Please note that the cable plug must be ordered separately, see **“Cable plug Type 2507, form B according to industry standard”** on [page 13](#) or separate data sheet for **Type 2507** ▶.
- Refer to chapter **“3. Approvals and conformities”** on [page 4](#) for more information about the approvals.

Circuit function	Port connection	Orifice	Approvals	K _{vs} -value	Nominal pressure	Article no. Brass body	Article no. Stainless steel body
		[mm]		water			
CF A 2/2-way solenoid proportional control valve Direct-acting Normally closed 	G 1/8	0.8	–	0.018	12	238928	238930
	G 1/8		UR	0.018	12	275025	275030
	G 1/8	1.0	–	0.027	10	238936	238931
	G 1/8		UR	0.027	10	275026	275031
	G 1/8	1.2	–	0.038	8	238937	238932
	G 1/8		UR	0.038	8	275027	275032
	G 1/8	1.6	–	0.055	6	238939	238933
	G 1/8		UR	0.055	6	275028	275033
	G 1/8	2.0	–	0.090	3	238940	238934
	G 1/8		UR	0.090	3	275029	275034

Further versions on request			
	Material Seal material FFKM Seal material EPDM		Analytical Oxygen version, parts oil-, fat- and silicon free
	Coil 12 V Coil Wire leads 300 mm		Approval UR (UL recognized)

DTS 1000173853 EN Version: U Status: RL (released | freigegeben | validé) printed: 25.10.2023

8.6. Ordering chart accessories

Cable plug Type 2507, form B according to industry standard

Note:

- Delivery of cable plug includes a flat seal and a fixing screw.
- Refer to data sheet **Type 2507** ▶ for more information about the cable plug.

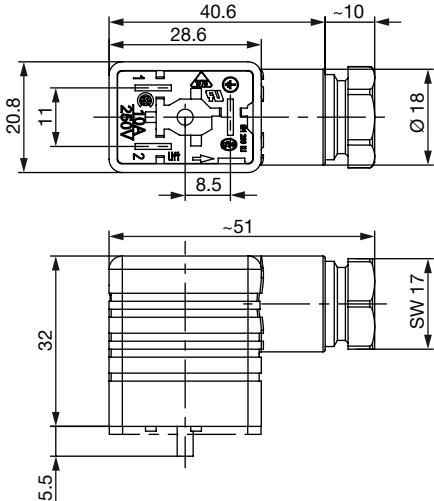
Cable plug	Dimensions	Version	Voltage	Article no.
		Without circuitry (standard)	2...250 V AC/DC	423845

Control electronics Type 8605 for proportional valves

Note:

Refer to data sheet **Type 8605** ▶ for more information about the control electronics.

Control electronics	Version	Max. coil current range [mA]	Voltage		Article no.
			24 V DC	12 V DC	
	Standard rail	40...220	o. r.	–	316531
	Standard rail	200...1000	o. r.	o. r.	316532

o. r. = on request
 – = not available

DTS 1000173853 EN Version: U Status: RL (released | freigegeben | valide) printed: 25.10.2023