

## Type 8792, 8793

Electropneumatic positioner and process controller



## Operating Instructions

We reserve the right to make technical changes without notice.  
Technische Änderungen vorbehalten.  
Sous réserve de modification techniques.

© Bürkert Werke GmbH & Co. KG, 2009 - 2022

Operating Instructions 2208/08\_EN-en\_00806089 / Original DE

## CONTENTS

<b>1</b>	<b>OPERATING INSTRUCTIONS .....</b>	<b>13</b>
1.1	Symbols.....	13
1.2	Definition of the term “device” .....	13
<b>2</b>	<b>AUTHORIZED USE .....</b>	<b>14</b>
2.1	Restrictions .....	14
<b>3</b>	<b>BASIC SAFETY INSTRUCTIONS .....</b>	<b>15</b>
<b>4</b>	<b>GENERAL INFORMATION.....</b>	<b>17</b>
4.1	Scope of supply .....	17
4.2	Contact address.....	17
4.3	Warranty .....	17
4.4	Master code .....	17
4.5	Information on the internet .....	17
<b>5</b>	<b>DESCRIPTION OF SYSTEM .....</b>	<b>18</b>
5.1	General description.....	18
5.1.1	Features .....	18
5.1.2	Combination with valve types and mounting versions .....	19
5.1.3	Overview of the mounting options.....	20
5.2	Designs.....	21
5.2.1	Type 8792, positioner .....	21
5.2.2	Type 8793, process controller .....	21
5.2.3	Type 8793, Remote-Design .....	21
<b>6</b>	<b>STRUCTURE.....</b>	<b>22</b>
6.1	Representation.....	22
6.2	Function diagram .....	23
6.2.1	Diagram illustrating single-acting actuator .....	23
<b>7</b>	<b>POSITIONER TYPE 8792 .....</b>	<b>24</b>
7.1	Schematic representation of the position control .....	25
7.2	Positioner software .....	26

<b>8</b>	<b>PROCESS CONTROLLER TYPE 8793</b> .....	<b>28</b>
8.1	Schematic representation of process control .....	29
8.2	The process controller software.....	30
<b>9</b>	<b>INTERFACES OF THE POSITIONER / PROCESS CONTROLLER</b> .....	<b>32</b>
<b>10</b>	<b>TECHNICAL DATA</b> .....	<b>33</b>
10.1	Conformity.....	33
10.2	Standards .....	33
10.3	Approval .....	33
10.4	Operating conditions .....	33
10.5	Type label .....	34
10.6	Mechanical data.....	34
10.7	Electrical data .....	35
10.8	Pneumatic data .....	36
10.9	Safety end positions after failure of the electrical or pneumatic auxiliary power.....	37
10.10	Factory settings.....	38
<b>11</b>	<b>ACCESSORIES</b> .....	<b>38</b>
11.1	Communications software.....	38
<b>12</b>	<b>ATTACHMENT AND ASSEMBLY</b> .....	<b>39</b>
12.1	Safety instructions .....	39
12.2	Attachment to a continuous valve with linear actuators according to NAMUR.....	40
12.2.1	Attachment kit for linear actuators (article no. 787215).....	40
12.2.2	Installation .....	41
12.2.3	Attaching mounting bracket .....	43
12.2.4	Aligning lever mechanism.....	44
12.3	Attachment to a continuous valve with rotary actuator .....	45
12.3.1	Mounting kit (VDI/VDE 3845) on rotary actuator (article no. 787338).....	45
12.3.2	Installation .....	45
12.4	Remote operation with external position sensor.....	48
12.4.1	Mounting accessories .....	48
12.4.2	Connection and start-up of the Remote Sensor Type 8798.....	49
12.4.3	Connection and start-up via a 4 – 20 mA position sensor (for Type 8793 remote model only) .....	50
<b>13</b>	<b>PNEUMATIC CONNECTION</b> .....	<b>51</b>
13.1	Safety instructions .....	51

<b>14</b>	<b>ELECTRICAL CONNECTION - CIRCULAR PLUG-IN CONNECTOR.....</b>	<b>53</b>
14.1	Type 8792 - designation of the circular plug-in connectors .....	53
14.2	Connection of the positioner Type 8792 .....	54
14.2.1	X1 - M12, 8-pole circular connector .....	54
14.2.2	X4 - M8, 4-pole socket (for binary outputs option only) Output signals to the control centre (e.g. PLC) .....	54
14.3	Type 8793 - designation of the circular plug-in connectors and contacts.....	55
14.4	Connecting the process controller Type 8793.....	56
14.4.1	X5 - M8, 4-pole circular connector, plug assignments of the process actual value input .....	56
<b>15</b>	<b>ELECTRICAL CONNECTION - CABLE GLAND .....</b>	<b>57</b>
15.1	Connection board of the Type 8792/8793 with screw-type terminals.....	57
15.2	Terminal assignment for cable gland - positioner Type 8792 .....	58
15.2.1	Input signals from the control centre (e.g. PLC) .....	58
15.2.2	Output signals to the control centre (e.g. PLC) (required for analogue output and/or binary output option only) .....	58
15.2.3	Operating voltage .....	59
15.2.4	Terminal assignment for external position sensor (for remote model only) .....	59
15.3	Terminal assignment for cable gland - process controller Type 8793.....	60
15.3.1	Terminal assignments of the process actual value input.....	60
<b>16</b>	<b>OPERATING LEVELS.....</b>	<b>61</b>
16.1	Switching between the operating levels .....	61
<b>17</b>	<b>OPERATING AND DISPLAY ELEMENTS .....</b>	<b>62</b>
17.1	Description of the operating and display elements.....	62
17.1.1	Description of the symbols which are displayed on the process level.....	63
17.2	Function of the keys.....	64
17.2.1	Entering and changing numerical values.....	65
17.3	Adjusting the display .....	66
17.3.1	Possible displays of the process level.....	66
17.4	Date and time .....	68
17.4.1	Setting date and time .....	69
<b>18</b>	<b>OPERATING STATES .....</b>	<b>70</b>
18.1	Changing the operating state.....	70
<b>19</b>	<b>ACTIVATING AND DEACTIVATING AUXILIARY FUNCTIONS.....</b>	<b>71</b>
19.1	Activating auxiliary functions .....	71
19.2	Deactivating auxiliary functions .....	72

20	MANUALLY OPENING AND CLOSING THE VALVE.....	73
21	START-UP .....	74
22	BASIC SETTING OF THE DEVICE.....	75
22.1	<i>INPUT</i> - Setting the input signal.....	76
22.2	<i>X.TUNE</i> – Automatic adjustment of the positioner.....	77
22.2.1	<i>X.TUNE.CONFIG</i> – Manual configuration of <i>X.TUNE</i> .....	79
23	ACTIVATION OF THE PROCESS CONTROLLER .....	80
24	BASIC SETTING OF THE PROCESS CONTROLLER.....	81
24.1	<i>P.CONTROL</i> – Setting up and parameterization of the process controller .....	81
24.2	<i>SETUP</i> – Setting up the process controller .....	83
24.2.1	<i>PV-INPUT</i> – Specifying signal type for the process actual value.....	83
24.2.2	<i>PV-SCALE</i> – Scaling of the process actual value .....	84
24.2.3	<i>SP-INPUT</i> – Type of the set-point value default (intern or extern) .....	88
24.2.4	<i>SP-SCALE</i> – Scaling of the process set-point value (for external set-point value default only) .....	88
24.2.5	<i>P.CO-INIT</i> – Smooth switchover MANUAL-AUTOMATIC .....	90
24.3	<i>PID.PARAMETER</i> – Parameterizing the process controller .....	91
24.3.1	Procedure for inputting the parameters.....	91
24.3.2	<i>DBND</i> – Insensitivity range (dead band).....	92
24.3.3	<i>KP</i> – Amplification factor of the process controller .....	92
24.3.4	<i>TN</i> – Reset time of the process controller .....	93
24.3.5	<i>TV</i> – Hold-back time of the process controller.....	93
24.3.6	<i>X0</i> – Operating point of the process controller.....	93
24.3.7	<i>FILTER</i> – Filtering of the process actual value input .....	94
24.4	<i>P.Q'LIN</i> – Linearization of the process characteristic .....	95
24.5	<i>P.TUNE</i> – Self-optimization of the process controller .....	96
24.5.1	The mode of operation of <i>P.TUNE</i> .....	96
24.5.2	Preparatory measure for execution of <i>P.TUNE</i> .....	96
24.5.3	Starting the function <i>P.TUNE</i> .....	98
25	CONFIGURING THE AUXILIARY FUNCTIONS.....	100
25.1	Activating and deactivating auxiliary functions.....	100
25.1.1	Including auxiliary functions in the main menu.....	100
25.1.2	Removing auxiliary functions from the main menu .....	101
25.1.3	Principle of including auxiliary functions in the main menu.....	101

<b>25.2</b>	<b>Overview and description of the auxiliary functions .....</b>	<b>102</b>
25.2.1	<b>CHARACT</b> – Select the transfer characteristic between input signal (position set-point value) and stroke .....	103
25.2.2	<b>CUTOFF</b> – Sealing function.....	107
25.2.3	<b>DIR.CMD</b> – Sense of effective direction of the positioner set-point value .....	109
25.2.4	<b>DIR.ACT</b> – Sense of effective direction of the actuator drive.....	110
25.2.5	<b>SPLTRNG</b> – Signal split range.....	111
25.2.6	<b>X.LIMIT</b> – Limits the mechanical stroke range .....	112
25.2.7	<b>X.TIME</b> – Limiting the control speed .....	113
25.2.8	<b>X.CONTROL</b> – Parameterization of the positioner .....	114
25.2.9	<b>P.CONTROL</b> – Setting up and parameterization of the process controller .....	115
25.2.10	<b>SECURITY</b> – Code protection for the settings.....	116
25.2.11	<b>SAFEPOS</b> – Input the safety position .....	118
25.2.12	<b>SIG.ERROR</b> – Configuration of signal level fault detection.....	119
25.2.13	<b>BINARY.IN</b> – Activation of the binary input .....	120
25.2.14	<b>OUTPUT</b> – Configuring the outputs (option).....	122
25.2.15	<b>CAL.USER</b> – Calibration of actual value and set-point value .....	128
25.2.16	<b>SET.FACTORY</b> – Resetting to the factory settings.....	133
25.2.17	<b>SER. IO</b> – Settings of the serial interface .....	134
25.2.18	<b>EXTRAS</b> – Setting the display.....	135
25.2.19	<b>POS.SENSOR</b> – Setting interface remote position sensor.....	138
25.2.20	<b>SERVICE</b> .....	138
25.2.21	<b>SIMULATION</b> – Menu for simulation of set-point value, process and process valve .. 139	
25.2.22	<b>DIAGNOSE</b> – Menu for monitoring valves (option).....	144
<b>25.3</b>	<b>Manual configuration of X.TUNE .....</b>	<b>164</b>
25.3.1	Description of the menu for the manual configuration of X.TUNE .....	165
<b>26</b>	<b>OPERATING STRUCTURE AND FACTORY SETTINGS.....</b>	<b>169</b>
<b>27</b>	<b>PROFIBUS DP .....</b>	<b>184</b>
27.1	Technical data .....	184
27.2	Interfaces.....	184
27.3	Changing the operating state.....	185
27.4	Safety settings if the bus fails .....	185
27.5	Bus status display.....	185
27.6	Differences between the field bus devices and devices without a field bus .....	185

<b>27.7</b>	<b>Electrical connections .....</b>	<b>186</b>
27.7.1	Connection diagram Type 8792.....	187
27.7.2	Connection diagram Type 8793.....	187
27.7.3	X1 - M12, 8-pole circular connector .....	188
27.7.4	X2/X3 - M12, 5-pole socket/circular connector - bus connection .....	188
27.7.5	X4 - M8, 4-pole socket, optional - Remote Sensor (for remote model only).....	189
27.7.6	X5 - M8, 4-pole circular connector - process actual value (Type 8793 only) .....	190
<b>27.8</b>	<b>Start-up PROFIBUS DP .....</b>	<b>191</b>
27.8.1	Safety instructions.....	191
27.8.2	Start-up sequence.....	191
27.8.3	<b>BUS.COMM</b> – Settings on Type 8792/8793.....	192
<b>27.9</b>	<b>Configuration via the control (PROFIBUS DP Master) .....</b>	<b>194</b>
27.9.1	Supplementary literature on the configuration of the PROFIBUS DP .....	194
27.9.2	Configuration of the process values .....	194
<b>27.10</b>	<b>Configuration with Siemens Step7 .....</b>	<b>197</b>
27.10.1	Example 1 of a positioner (Type 8792): Transfer of set-point and actual value.....	197
27.10.2	Example 2 of a process controller (Type 8793): Transfer of several process values.....	198
<b>28</b>	<b>MAINTENANCE .....</b>	<b>199</b>
<b>29</b>	<b>ERROR MESSAGES AND MALFUNCTIONS .....</b>	<b>199</b>
<b>29.1</b>	<b>Error messages on the display.....</b>	<b>199</b>
29.1.1	General error messages.....	199
29.1.2	Error and warning messages while the <i>X.TUNE</i> function is running.....	200
29.1.3	Error messages while the <i>P.Q'LIN</i> function is running .....	201
29.1.4	Error messages while the <i>P.TUNE</i> function is running .....	201
29.1.5	Error Messages on Field Bus Devices.....	202
<b>29.2</b>	<b>Other faults.....</b>	<b>202</b>
<b>30</b>	<b>PACKAGING AND TRANSPORT .....</b>	<b>203</b>
<b>31</b>	<b>STORAGE .....</b>	<b>203</b>
<b>32</b>	<b>DISPOSAL .....</b>	<b>203</b>
<b>33</b>	<b>SELECTION CRITERIA FOR CONTINUOUS VALVES.....</b>	<b>204</b>



<b>34</b>	<b>PROPERTIES OF PID CONTROLLERS .....</b>	<b>206</b>
34.1	P-portion.....	206
34.2	I-portion.....	207
34.3	D-portion .....	208
34.4	Superposition of P, I and D Portions .....	209
34.5	Implemented PID controller.....	210
	34.5.2 Function of the real PID controller .....	210
<b>35</b>	<b>ADJUSTMENT RULES FOR PID CONTROLLERS .....</b>	<b>211</b>
35.1	Adjustment rules according to Ziegler and Nichols (oscillation method).....	211
35.2	Adjustment rules according to Chien, Hrones and Reswick (actuating variable jump method) 213	
<b>36</b>	<b>TABLE FOR YOUR SETTINGS ON THE POSITIONER .....</b>	<b>215</b>
36.1	Settings of the freely programmable characteristic .....	215
<b>37</b>	<b>TABLE FOR YOUR SETTINGS ON THE PROCESS CONTROLLER TYPE 8793 .....</b>	<b>216</b>
37.1	Set parameters of the process controller .....	216



# 1 OPERATING INSTRUCTIONS

The operating instructions describe the entire life cycle of the device. Keep these instructions in a location which is easily accessible to every user and make these instructions available to every new owner of the device.



## WARNING!

The operating instructions contain important safety information.

Failure to observe these instructions may result in hazardous situations.

- ▶ The operating instructions must be read and understood.

## 1.1 Symbols



## DANGER!

Warns of an immediate danger.

- ▶ Failure to observe the warning may result in a fatal or serious injury.



## WARNING!

Warns of a potentially dangerous situation.

- ▶ Failure to observe the warning may result in serious injuries or death.



## CAUTION!

Warns of a possible danger.

- ▶ Failure to observe this warning may result in a medium or minor injury.

## NOTE!

Warns of damage to property.

- ▶ Failure to observe the warning may result in damage to the device or the equipment.



indicates important additional information, tips and recommendations.



refers to information in these operating instructions or in other documentation.

→ designates a procedure that must be carried out.

## 1.2 Definition of the term “device”

In these instructions, the term “device” always refers to the Type 8792/8793

## 2 AUTHORIZED USE

Incorrect use of the Type 8792 and 8793 can be dangerous to people, nearby equipment and the environment.

The device is designed for the open-loop control and closed-loop control of media.

- ▶ In the potentially explosive atmosphere use only devices with the Ex additional plate.
- ▶ For use in the potentially explosive atmosphere follow the Ex additional instructions and the instructions on the Ex additional plate.
- ▶ The device must not be exposed to direct sunlight.
- ▶ Pulsating direct voltage (rectified alternating voltage without smoothing) must not be used as operating voltage.
- ▶ During use observe the permitted data, the operating conditions and conditions of use specified in the contract documents and operating instructions, as described in chapter “[10 Technical data](#)” in this manual and in the valve manual for the respective pneumatically actuated valve.
- ▶ The device may be used only in conjunction with third-party devices and components recommended and authorised by Bürkert.
- ▶ In view of the wide range of possible application cases, check whether the device is suitable for the specific application case and check this out if required.
- ▶ Correct transportation, correct storage and installation and careful use and maintenance are essential for reliable and faultless operation.
- ▶ Use the Type 8792 and 8793 only as intended.

### 2.1 Restrictions

If exporting the system/device, observe any existing restrictions.

### 3 BASIC SAFETY INSTRUCTIONS

These safety instructions do not consider any contingencies or incidents which occur during installation, operation and maintenance.

The operator is responsible for observing the location-specific safety regulations, also with reference to the personnel.



#### **Danger – high pressure.**

- ▶ Before loosening the pneumatic lines and valves, turn off the pressure and vent the pneumatic lines.

#### **Risk of electric shock.**

- ▶ Before reaching into the device or the equipment, switch off the power supply and secure to prevent reactivation.
- ▶ Observe applicable accident prevention and safety regulations for electrical equipment.

#### **General hazardous situations.**

To prevent injury, ensure that:

- ▶ That the system cannot be activated unintentionally.
- ▶ Installation and repair work may be carried out by authorised technicians only and with the appropriate tools.
- ▶ After an interruption in the power supply or pneumatic supply, ensure that the process is restarted in a defined or controlled manner.
- ▶ The device may be operated only when in perfect condition and in consideration of the operating instructions.
- ▶ Do not supply the supply pressure connection of the system with aggressive or flammable mediums.
- ▶ Do not supply the supply pressure connection with any liquids.
- ▶ Do not put any loads on the housing (e.g. by placing objects on it or standing on it).
- ▶ Do not make any external modifications to the device housings. Do not paint the housing parts or screws.
- ▶ The general rules of technology apply to application planning and operation of the device.

#### **NOTE!**

##### **Electrostatic sensitive components / modules.**

The device contains electronic components which react sensitively to electrostatic discharge (ESD). Contact with electrostatically charged persons or objects is hazardous to these components. In the worst case scenario, they will be destroyed immediately or will fail after start-up.

- ▶ Observe the requirements in accordance with EN 61340-5-1 to minimise or avoid the possibility of damage caused by sudden electrostatic discharge.
- ▶ Also ensure that you do not touch electronic components when the operating voltage is present.



The Type 8792/8793 were developed with due consideration given to the accepted safety rules and are state-of-the-art. Nevertheless, dangerous situations may occur.

Failure to observe this operating manual and its operating instructions as well as unauthorized tampering with the device release us from any liability and also invalidate the warranty covering the devices and accessories.

## 4 GENERAL INFORMATION

### 4.1 Scope of supply

In general it consists of:

Type 8792/8793 and Quickstart in printed form.



We will provide you with attachment kits for linear actuators or rotary actuators as accessories. For the circular plug-in connector version (multi-pole version) of Type 8792/8793, we will provide you with suitable cable connectors as accessories.

If there are any discrepancies, please contact us immediately.

### 4.2 Contact address

#### Germany

Bürkert Fluid Control Systems  
Chr.-Bürkert-Str. 13-17  
D-74653 Ingelfingen  
E-mail: [info@burkert.com](mailto:info@burkert.com)

#### International

Contact addresses can be found on the final pages of the printed brief instructions (Quickstart).

And also on the internet at: [www.burkert.com](http://www.burkert.com)

### 4.3 Warranty

The warranty is only valid if the Type 8792/8793 are used as intended in accordance with the specified application conditions.

### 4.4 Master code

Operation of the device can be locked via a freely selectable user code. In addition, there is a non-changeable master code with which you can perform all operator actions on the device. This 4-digit master code can be found on the last pages of the printed brief instructions which are enclosed with each device.

If required, cut out the code and keep it separate from these operating instructions.

### 4.5 Information on the internet

The operating instructions and data sheets for Type 8792 and 8793 can be found on the Internet at:

[www.burkert.com](http://www.burkert.com)

## 5 DESCRIPTION OF SYSTEM

### 5.1 General description

The positioner Type 8792 / process controller Type 8793 is a digital, electro-pneumatic positioner for pneumatically actuated continuous valves. The device incorporates the main function groups

- Position sensor
- Electro-pneumatic control system
- Microprocessor electronics

The position sensor measures the current positions of the continuous valve.

The microprocessor electronics continuously compare the current position (actual value) with a set-point position value specified via the standard signal input and supplies the result to the positioner/process controller.

If there is a control difference, the electro-pneumatic control system corrects the actual position accordingly.

#### 5.1.1 Features

- **Models**
  - Positioner (positioner) Type 8792
  - Process controller with integrated positioner, Type 8793.
- **Position sensors**
  - intern high resolution conductive plastic potentiometer or
  - extern non-contact, non-wearing position sensor (remote).
- **Microprocessor-controlled electronics**
  - for signal processing, control and valve control.
- **Operating module**
  - Operation of the device is controlled by four keys. The 128 x 64 dot matrix graphics display enables you to display the set-point or actual value and to configure and parameterize via menu functions.
- **Control system**
  - The control system consists of 2 solenoid valves and 4 diaphragm reinforcers. In single-acting actuators the working connection 2 must be sealed with a threaded plug.
- **Feedback (optional)**
  - The feedback is implemented either via 2 proximity switches (initiators), via binary outputs or via an output (4 – 20 mA / 0 – 10 V).
  - When the valve reaches an upper or lower position, this position can be relayed e.g. to a PLC via binary outputs. The operator can change the initiators or limit positions via control lugs.
- **Pneumatic interfaces**
  - Internal thread G1/4"
- **Electrical interfaces**
  - Circular plug-in connector or cable gland
- **Housing**
  - Plastic-coated aluminium housing with hinged cover and captive screws.
- **Mounting**
  - on linear actuator according to NAMUR recommendation (DIN IEC 534-6) or on rotary actuator according to VDI/VDE 3845.



- **Optional**  
Remote version for DIN rail mounting or for mounting bracket

## 5.1.2 Combination with valve types and mounting versions

The positioner Type 8792 / process controller Type 8793 can be mounted on different continuous valves. For example on valves with piston, membrane or rotary actuator. The actuators can be single-acting or double-acting.

- For single-acting actuators, only one chamber is aerated and deaerated during actuation. The generated pressure works against a spring. The piston moves until there is an equilibrium of forces between compressive force and spring force. To do this, one of the two air connections must be sealed with a threaded plug.
- For double-acting actuators the chambers on both sides of the piston are pressurised. In this case, one chamber is aerated when the other one is deaerated and vice versa. In this design, no spring is installed in the actuator.

Two basic device versions are offered for the positioner Type 8792 / process controller Type 8793; they differ in the attachment option and in the position sensor.

### **Device version NAMUR:**

An internal position sensor is used which is designed as a rotary potentiometer. Type 8792/8793 is mounted directly on the actuator or attached to the side.

### **Device version Remote:**

An external position sensor (linear or rotative) via a digital interface.

The Type 8792/8793 is attached to a wall either with a DIN rail or with a mounting bracket (remote design).

### 5.1.3 Overview of the mounting options

<p>Mounting NAMUR on rotary actuator</p>	
<p>Mounting NAMUR with mounting bracket on a linear actuator</p>	
<p>Remote mounting with mounting bracket</p>	
<p>Remote mounting with DIN rail</p>	

MAN 1000118577 EN Version: K Status: RL (released | freigegeben) printed: 05.08.2022

Table 1: Overview of the mounting options

## 5.2 Designs

### 5.2.1 Type 8792, positioner

The position of the actuator is regulated according to the position set-point value. The position set-point value is specified by an external standard signal (or via field bus).

### 5.2.2 Type 8793, process controller

Type 8793 also features a PID controller which, apart from actual position control, can also be used to implement process control (e.g. level, pressure, flow rate, temperature) in the sense of a cascade control.

The process controller Type 8793 is operated with a 128 x 64 dot matrix graphics display and a keypad with 4 keys.

The process controller is linked to a control circuit. The position set-point value of the valve is calculated from the process set-point value and the actual process value via the control parameters (PID controller). The process set-point value can be set by an external signal.

### 5.2.3 Type 8793, Remote-Design



Depending on the connection type of the position sensor, Type 8793 functions as a

- Process controller or
- Positioner

The following connection options are possible:

Function Type 8793	Interface	Position sensor	Setting in the menu ( <i>ADD.FUNCTION</i> )
Process controller	digital (serial)	Remote Sensor Type 8798	<i>POS.SENSOR</i> → <i>DIGITAL</i> For menu description see Chapter <a href="#">“26.2.19”</a>
Positioner	analog (4...20 mA) *	Any, high-resolution position sensor	<i>POS.SENSOR</i> → <i>ANALOG</i> For menu description see Chapter <a href="#">“26.2.19”</a>

Table 2: Connection options type 8793 with external position position sensor



\* If the position sensor is connected to the process controller Type 8793 via the analog interface, it can be operated only as a positioner.

The options for connection of a position sensor are described in chapter [“12.4 Remote operation with external position sensor”](#).

## 6 STRUCTURE

The positioner Type 8792 and process controller Type 8793 consist of the micro-processor controlled electronics, the position sensor and the control system.

The device is designed using three-wire technology. Operation is controlled by four keys and a 128x64 dot matrix graphics display.

The pneumatic control system for single-acting and double-acting actuators consists of 2 solenoid valves.

### 6.1 Representation

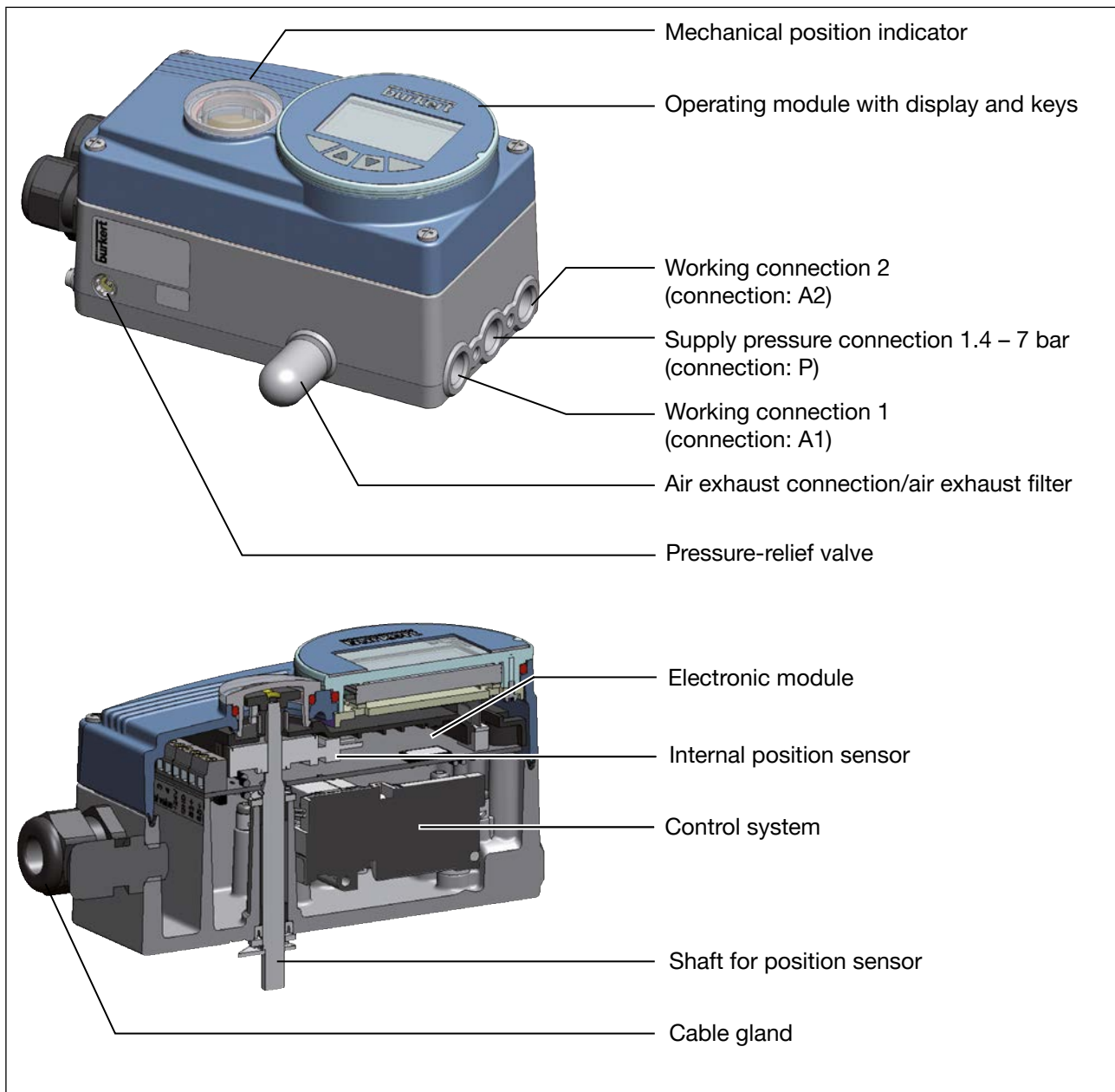


Fig. 1: Structure, Type 8792 / 8793

## 6.2 Function diagram

### 6.2.1 Diagram illustrating single-acting actuator

The black lines in “Fig. 2” specify the function of the positioner circuit in Type 8792.

The grey part of the diagram indicates the additional function of the superimposed process control circuit in Type 8793.

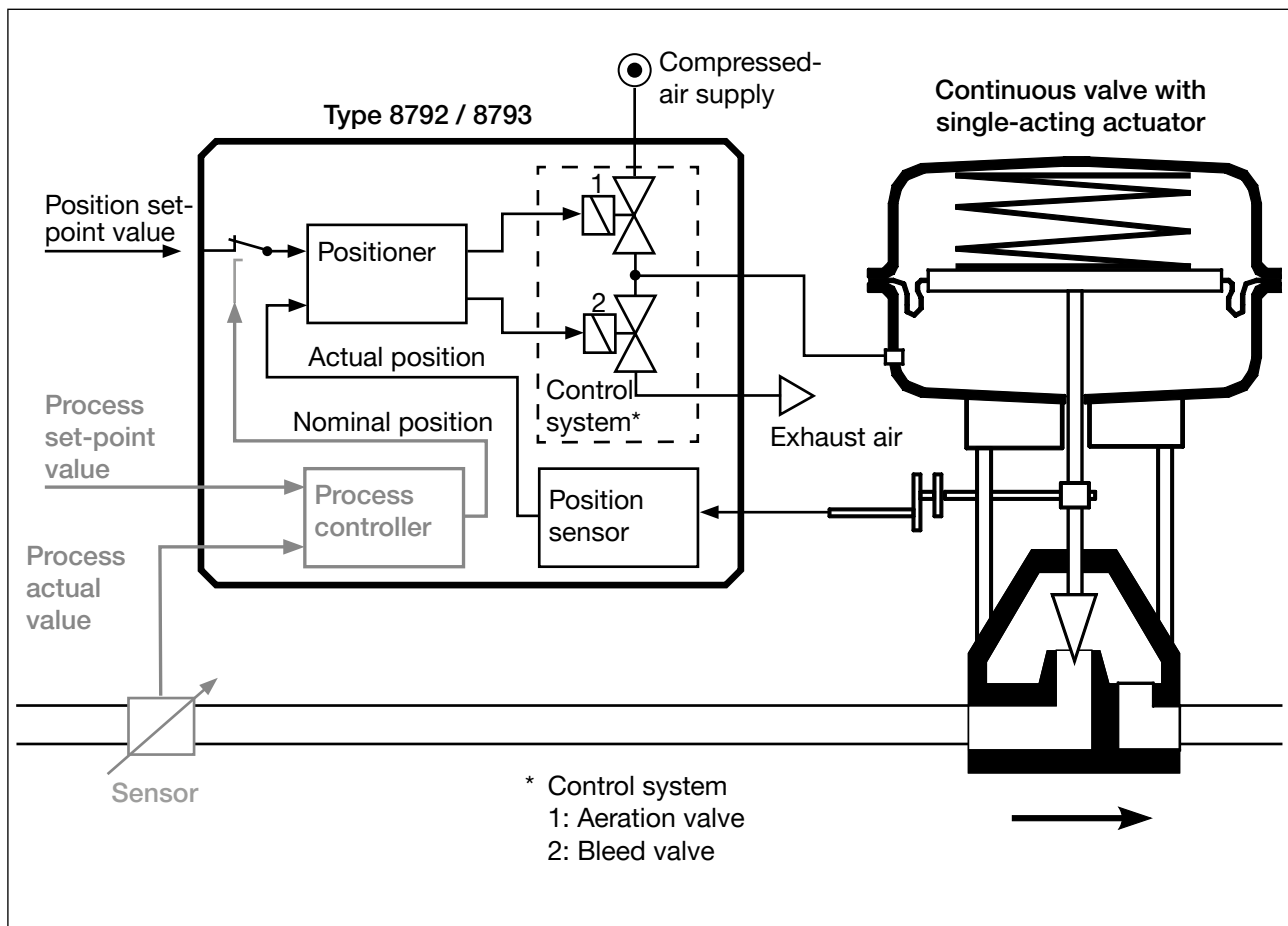


Fig. 2: Structure, positioner Type 8792 / process controller 8793



The remote design has the position sensor situated outside the device directly on the continuous valve and is connected to the latter by a cable.

## 7 POSITIONER TYPE 8792

The position sensor records the current position (*POS*) of the pneumatic actuator. The positioner compares this actual position value with the set-point value (*CMD*) which is specified as a standard signal. If there is a control difference ( $X_{d1}$ ), the actuator is aerated and deaerated via the control system. In this way the position of the actuator is changed until control difference is 0.  $Z_1$  represents a disturbance variable.

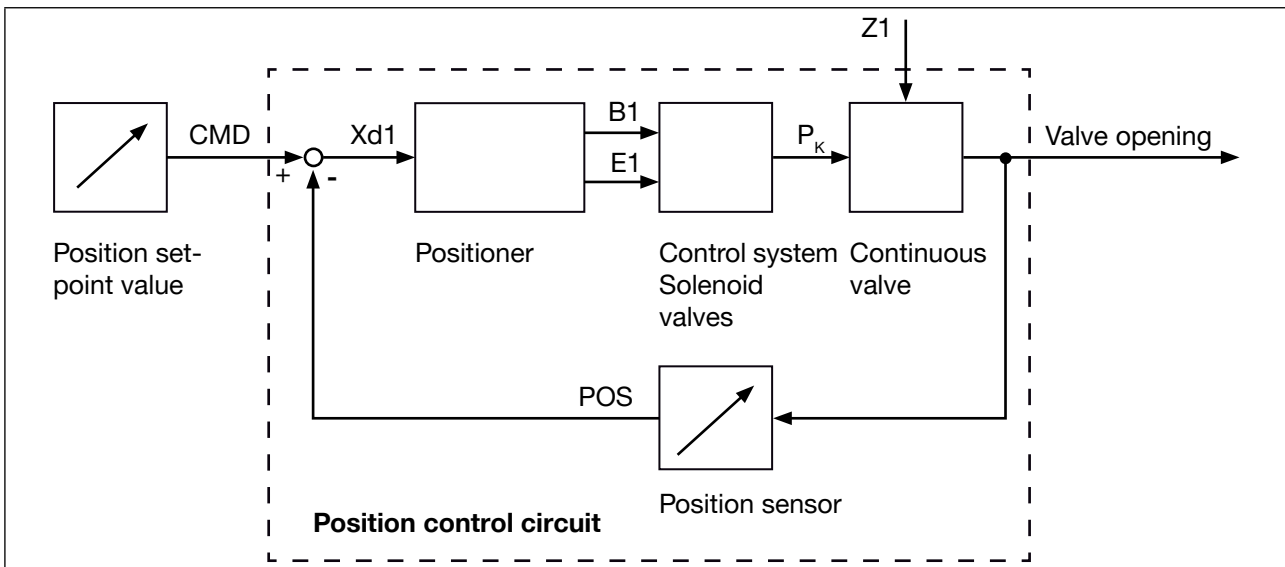


Fig. 3: Position control circuit in Type 8792

## 7.1 Schematic representation of the position control

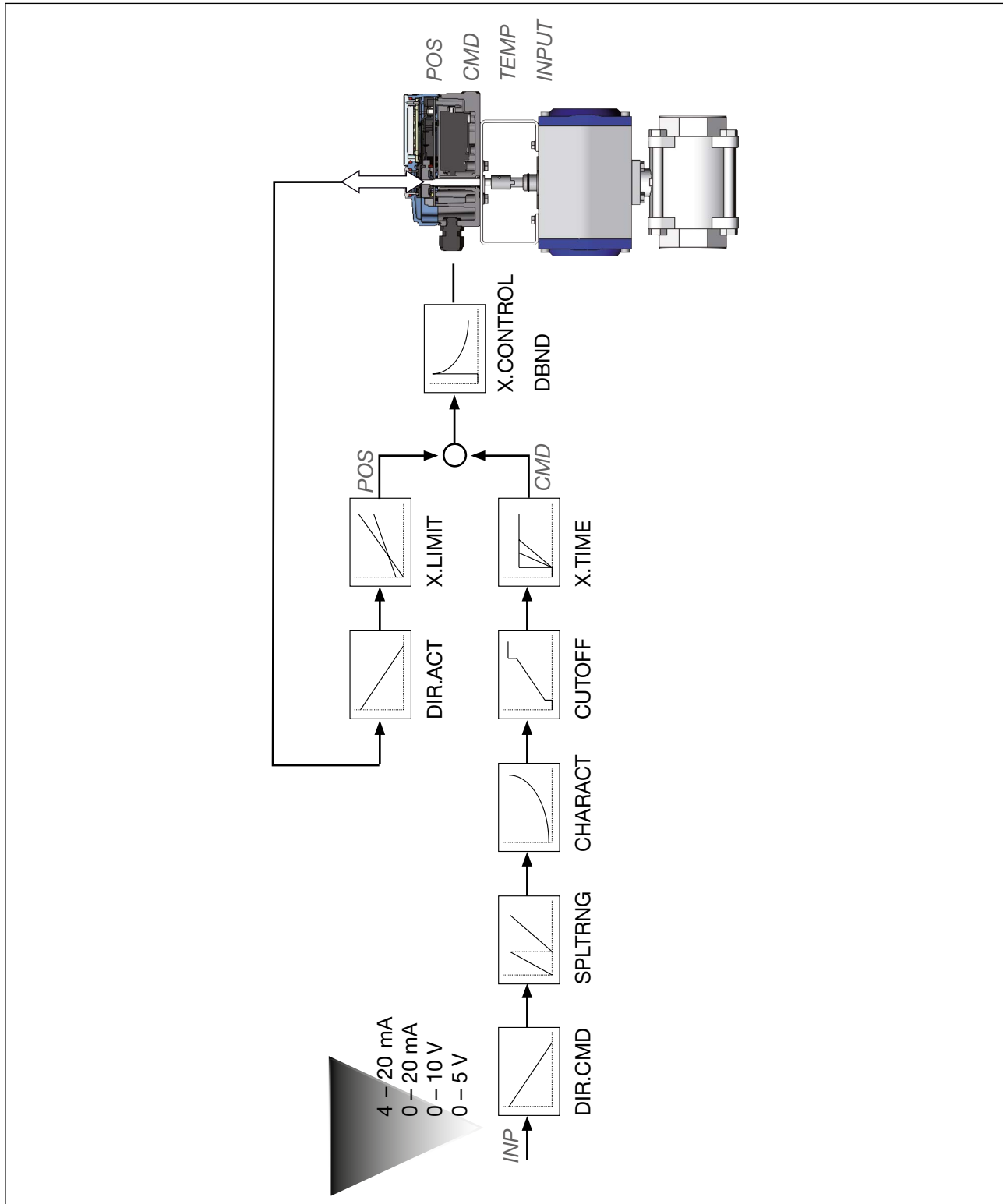


Fig. 4: Schematic representation of position control

## 7.2 Positioner software

Configurable auxiliary functions	Effect
Correction line to adjust the operating characteristic <i>CHARACT</i>	Selection of the transfer characteristic between input signal and stroke (correction characteristic)
Sealing function <i>CUTOFF</i>	Valve closes tight outside the control range. Specification of the value (in %), from which the actuator is completely deaerated (when 0%) or aerated (when 100%).
Sense of effective direction of the controller set-point value <i>DIR.CMD</i>	Reversal of the sense of effective direction of the set-point value
Sense of effective direction of the actuator <i>DIR.ACT</i>	Adjustment of the sense of effective direction between aeration state of the actuator and the actual position
Signal range splitting <i>SPLTRNG</i>	Splitting of the standard signal range to two or more positioners
Stroke limit <i>X.LIMIT</i>	Mechanical valve piston movement only within a defined stroke range
Limiting the control speed <i>X.TIME</i>	Input of the opening and closing time for the entire stroke
Insensitivity range <i>X.CONTROL</i>	The positioner is initially actuated from a control difference to be defined
Code protection <i>SECURITY</i>	Code protection for settings
Safety position <i>SAFEPOS</i>	Definition of the safety position
Signal level error detection <i>SIG.ERROR</i>	Check the input signals for sensor break. Warning output on the display and start up of the safety position (if selected)
Binary input <i>BINARY. IN</i>	Switch over AUTOMATIC / MANUAL or Start up of the safety position
Analogue feedback (option) <i>OUTPUT</i>	Status signal set-point value or actual value
2 binary outputs (option) <i>OUTPUT</i>	Output of two selectable binary values
User calibration <i>CAL.USER</i>	Change to the factory calibration of the signal input
Factory settings <i>SET.FACTORY</i>	Reset to factory settings



Configurable auxiliary functions	Effect
Serial interface <i>SER.I/O</i>	Configuration of serial interface
Setting display <i>EXTRAS</i>	Adjustment of the display of the process level
<i>SERVICE</i>	For internal use only
<i>POS.SENSOR</i>	Setting interface remote position sensor (available for Type 8793 Remote only. See chapter <a href="#">“5.2.3 Typ 8793, Remote-Design”</a> ).
Simulation software <i>SIMULATION</i>	For simulation of the device functions
<i>DIAGNOSE (Option)</i>	Monitoring of processes

Table 3: Positioner software. Configurable auxiliary functions

Hierarchical operating concept for easy operation on the following operating levels	
Process level	On the process level switch between AUTOMATIC mode and MANUAL mode.
Setting level	On the setting level specify certain basic functions during start-up and, if required, configure additional functions

Table 4: The positioner software. Hierarchical operating concept.

## 8 PROCESS CONTROLLER TYPE 8793

In the case of process controller Type 8793 the position control mentioned in chapter “7” becomes the subordinate auxiliary control circuit; this results in a cascade control. The process controller in the main control circuit of Type 8793 has a PID function. The process set-point value ( $SP$ ) is specified as set-point value and compared with the actual value ( $PV$ ) of the process variable to be controlled. The position sensor records the current position ( $POS$ ) of the pneumatic actuator. The positioner compares this actual position value with the set-point value ( $CMD$ ), which is determined by the process controller. If there is a control difference ( $X_{d1}$ ), the actuator is aerated and deaerated via the control system. In this way the position of the actuator is changed until control difference is 0.  $Z_2$  represents a disturbance variable.

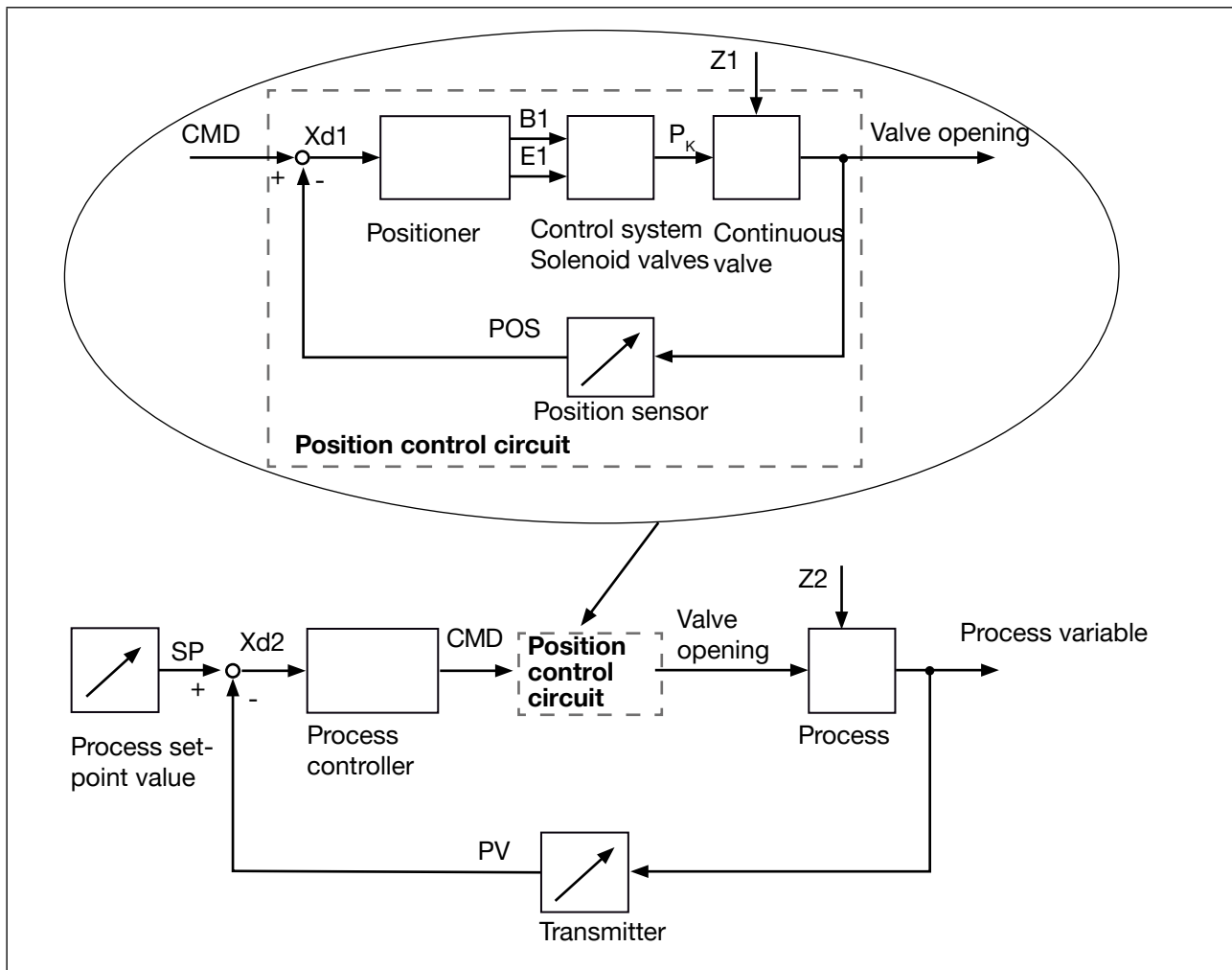
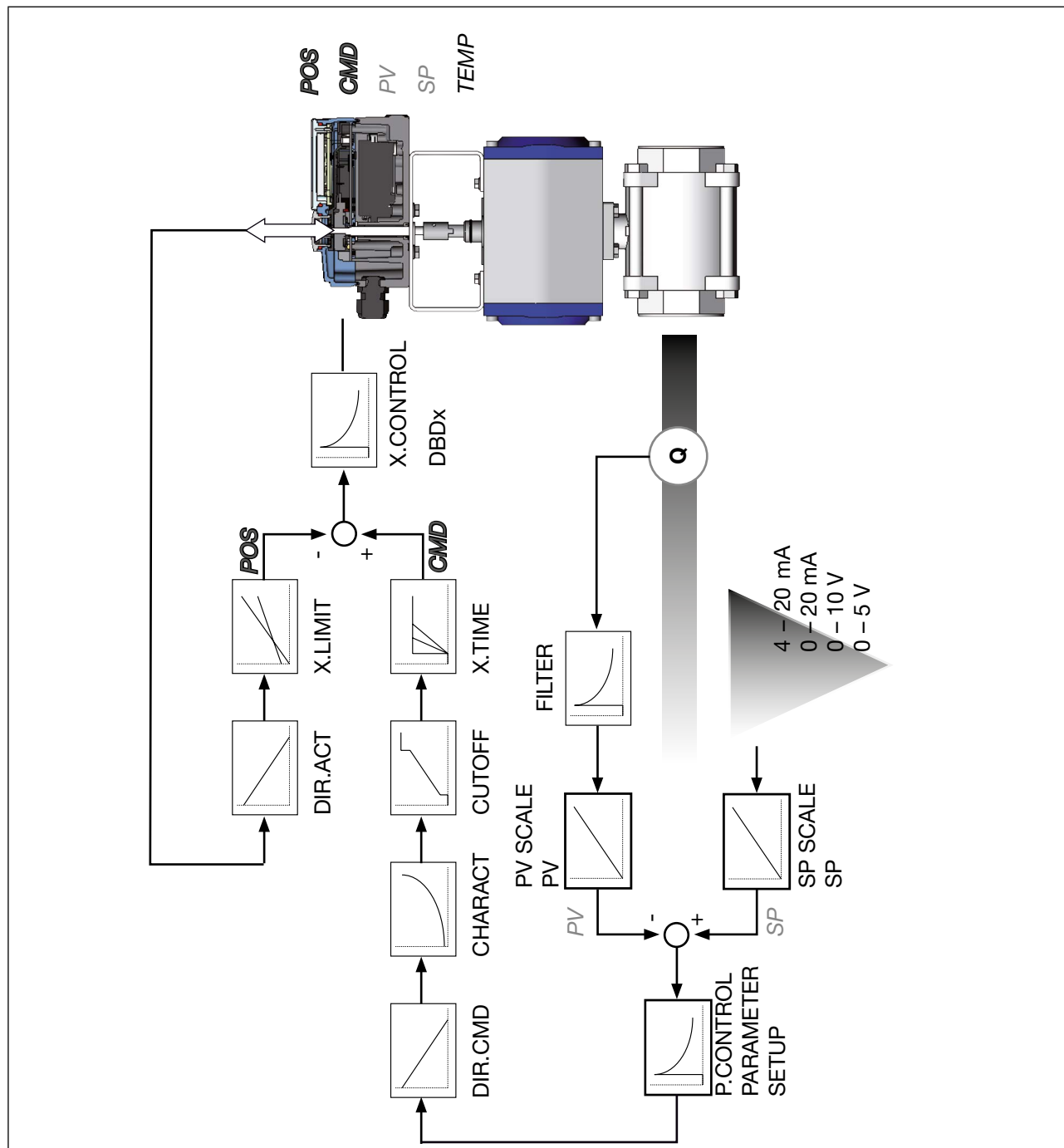


Fig. 5: Signal flow plan of process controller

## 8.1 Schematic representation of process control



MAN 1000118577 EN Version: K Status: RL (released | freigegeben) printed: 05.08.2022

Fig. 6: Schematic representation of process control

## 8.2 The process controller software

Configurable auxiliary functions	Effect
Correction line to adjust the operating characteristic <i>CHARACT</i>	Selection of the transfer characteristic between input signal and stroke (correction characteristic)
Sealing function <i>CUTOFF</i>	Valve closes tight outside the control range. Specification of the value (in %), from which the actuator is completely deaerated (when 0%) or aerated (when 100%).
Sense of effective direction of the controller set-point value <i>DIR.CMD</i>	Reversal of the sense of effective direction of the set-point value
Sense of effective direction of the actuator <i>DIR.ACT</i>	Adjustment of the sense of effective direction between aeration state of the actuator and the actual position
Signal range splitting <i>SPLTRNG</i>	Splitting of the standard signal range to two or more positioners
Stroke limit <i>X.LIMIT</i>	Mechanical valve piston movement only within a defined stroke range
Limiting the control speed <i>X.TIME</i>	Input of the opening and closing time for the entire stroke
Insensitivity range <i>X.CONTROL</i>	The positioner is initially actuated from a control difference to be defined
Code protection <i>SECURITY</i>	Code protection for settings
Safety position <i>SAFEPOS</i>	Definition of the safety position
Signal level error detection <i>SIG.ERROR</i>	Check the input signals for sensor break. Warning output on the display and start up of the safety position (if selected)
Binary input <i>BINARY.IN</i>	Switch over AUTOMATIC / MANUAL or Start up of the safety position
Analogue feedback (option) <i>OUTPUT</i>	Status signal set-point or actual value
2 binary outputs (option) <i>OUTPUT</i>	Output of two selectable binary values
User calibration <i>CAL.USER</i>	Change to the factory calibration of the signal input
Factory settings <i>SET.FACTORY</i>	Reset to factory settings
Serial interface <i>SER.I/O</i>	Configuration of serial interface
Setting display <i>EXTRAS</i>	Adjustment of the display of the process level

Configurable auxiliary functions	Effect
<i>SERVICE</i>	For internal use only
Simulation software <i>SIMULATION</i>	For simulation of the device functions
<i>DIAGNOSE (Option)</i>	Monitoring of processes
<i>POS.SENSOR</i>	Setting interface remote position sensor (available for Type 8793 Remote only. See chapter “5.2.3 Typ 8793, Remote-Design”.

Table 5: The process controller software. Configurable auxiliary functions of the positioner

Functions and setting options of the process controller	
Process controller <i>P.CONTROL</i>	PID - Process controller is activated
Adjustable parameters <i>P.CONTROL - PARAMETER</i>	Parameterization of the process controller Proportional coefficient, reset time, hold-back time and operating point
Scalable inputs <i>P.CONTROL - SETUP</i>	Configuration of the process controller - Selection of the sensor input - Scaling of process actual value and process set-point value Selection of the set-point value defaults
Automatic sensor detection or manual sensor setting <i>P.CONTROL - SETUP - PV INPUT</i>	Sensor types Pt100 and 4 – 20 mA are automatically detected or can be set manually via the operating menu
Selection of the set-point value specification <i>P.CONTROL - SETUP - SP INPUT</i>	Set-point value specification either via standard signal input or via keys
Process characteristic linearization <i>P.Q'LIN</i>	Function for automatic linearization of the process characteristics
Process controller optimization <i>P.TUNE</i>	Function for automatic optimization of the process controller parameters

Table 6: The process controller software. Functions and setting options of the process controller

Hierarchical operating concept for easy operation on the following operating levels	
Process level	On the process level switch between AUTOMATIC and MANUAL mode.
Setting level	On the setting level specify certain basic functions during start-up and configure auxiliary functions if required.

Table 7: The process controller software. Hierarchical operating concept

## 9 INTERFACES OF THE POSITIONER / PROCESS CONTROLLER

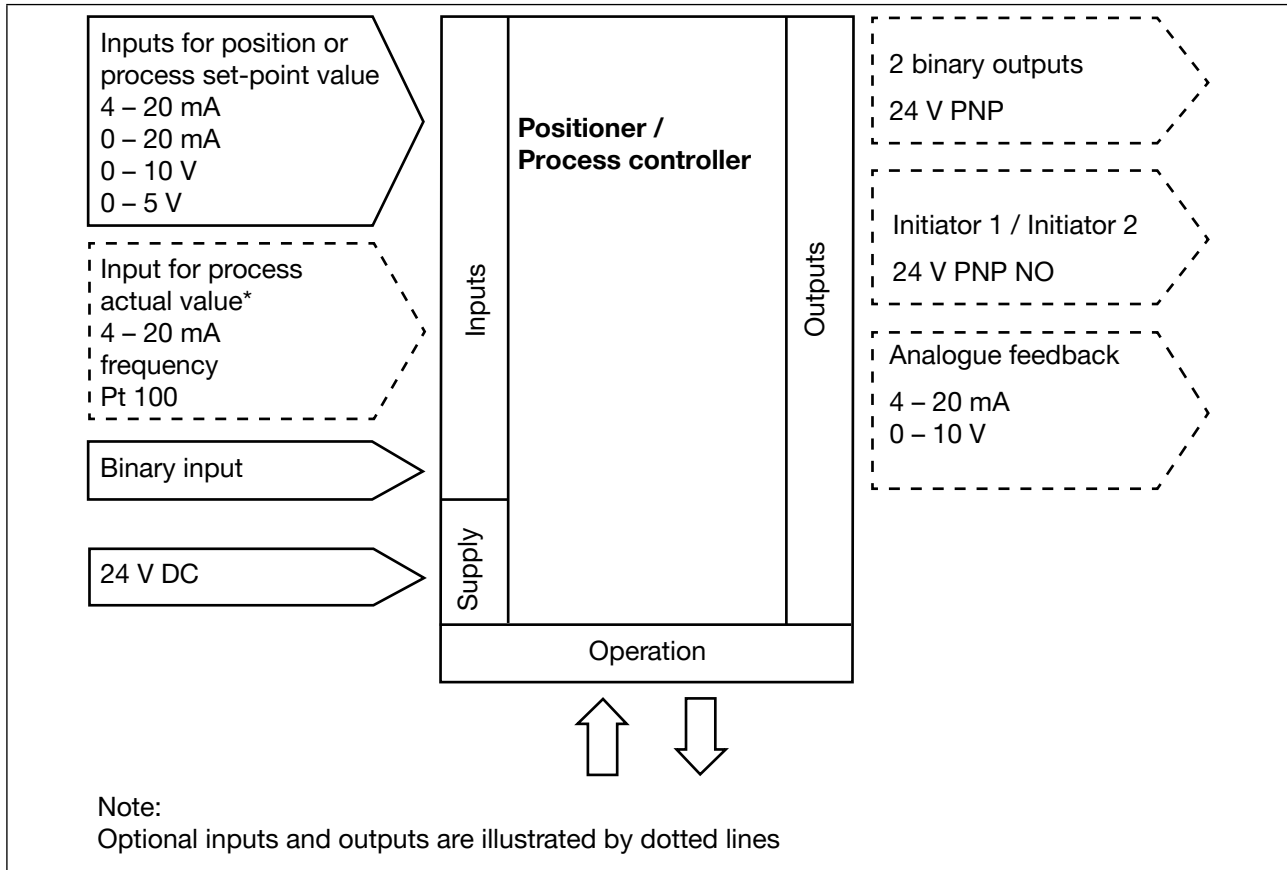


Fig. 7: Interfaces of the positioner / process controller



The Types 8792 and 8793 are 3-wire devices, i.e. the power (24 V DC) is supplied separately from the set-point value signal.

## 10 TECHNICAL DATA

### 10.1 Conformity

In accordance with the Declaration of conformity, Type 8792 / 8793 is compliant with the EC Directives.

### 10.2 Standards

The applied standards which are used to demonstrate compliance with the EC Directives are listed in the EC-Type Examination Certificate and/or the EC Declaration of Conformity.

### 10.3 Approval

According to Device Group II Category 3G/D, the product is approved for use in potentially explosive areas of Zones 2 and 22.



Follow instructions for use in potentially explosive areas. See additional instructions ATEX.

### 10.4 Operating conditions

#### NOTE!

If used outside, the device may be exposed to direct sunlight and temperature fluctuations which may cause malfunctions or leaks.

- ▶ If the device is used outdoors, do not expose it unprotected to the weather conditions.
- ▶ Ensure that the permitted ambient temperature does not exceed the maximum value or drop below the minimum value.

Environmental temperature	-10 – +60 °C
Degree of protection	IP 65 / IP 67* according to EN 60529 (only if cables, plugs and sockets have been connected correctly)

\* If the device is used under IP 67 conditions, the ventilation filter (see [“Fig. 1: Structure, Type 8792 / 8793”](#)) must be removed and the exhaust air conducted into the dry area.

## 10.5 Type label

Explanation of the device-specific specifications on the type label:

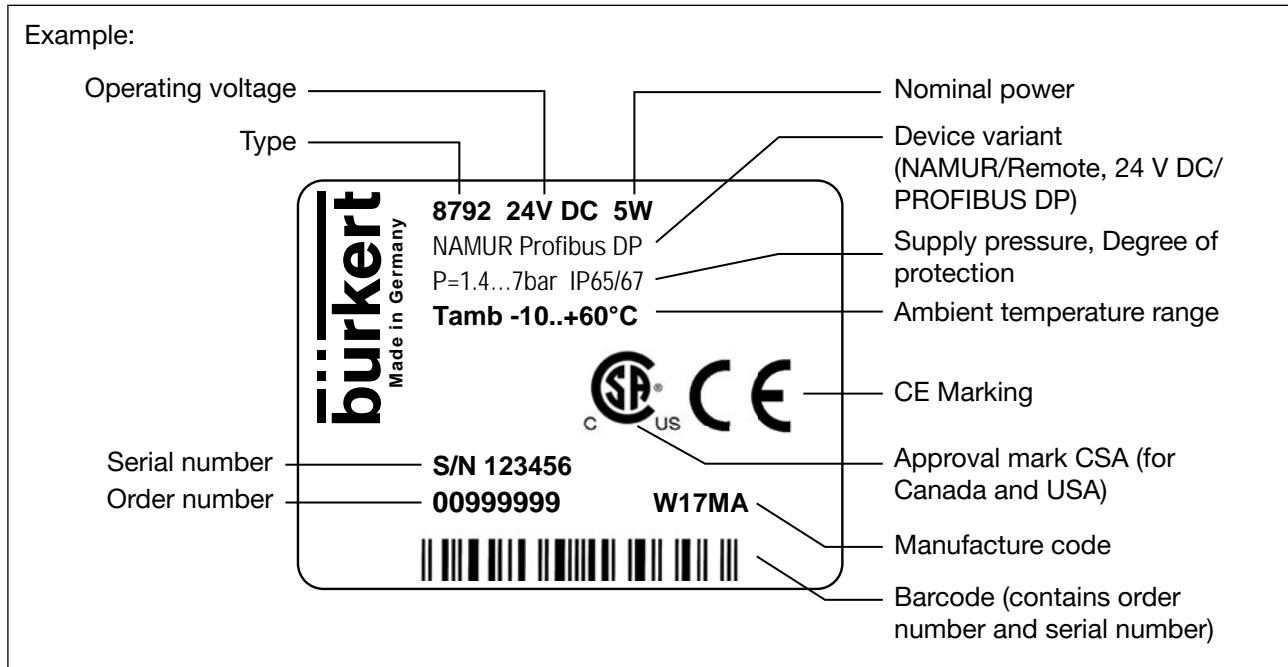


Fig. 8: Example of type label

## 10.6 Mechanical data

Dimensions	See data sheet
Material	
Housing material	Plastic-coated aluminium
Other external parts	Stainless steel (V4A), PC, PE, POM, PTFE
Sealing material	EPDM, NBR, FKM
Mass	approx. 1.0 kg



## 10.7 Electrical data

Connections	2 cable glands (M20 x 1.5) with screw-type terminals 0.14 – 1.5 mm <sup>2</sup> or circular plug-in connector	
Operating voltage	24 V DC ± 10% max. residual ripple 10%	
Power consumption	< 5 W	
Input data for actual value signal		
4 – 20 mA:	Input resistance	180 Ω
	Resolution	12 bit
Frequency:	Measuring range	0 – 1000 Hz
	Input resistance	17 kΩ
	Resolution	1‰ of the measured value,
	Input signal	> 300 mV <sub>ss</sub>
	Signal form	Sine, rectangle, triangle
Pt 100	Measuring range	-20 – +220 °C,
	Resolution	< 0.1 °C,
	Measurement current	< 1 mA
Input data for set-point value signal		
0/4 – 20 mA:	Input resistance	180 Ω
	Resolution	12 bit
0 – 5/10 V:	Input resistance	19 kΩ
	Resolution	12 bit
Protection class	III in accordance with DIN EN 61140 (VDE 0140-1)	
Analogue feedback		
max. current	10 mA (for voltage output 0 – 5/10 V)	
Burden (load)	0 – 560 Ω (for current output 0/4 – 20 mA)	
Inductive proximity switches	100 mA current limit	
Binary outputs		
Current limiting	galvanically isolated 100 mA, output is clocked if overload occurs	
Binary input		
	galvanically isolated 0 – 5 V = log “0”, 10 – 30 V = log “1” inverted input in reverse order (input current < 6 mA)	
Communication interface	Direct connection to PC via USB adapter with integrated interface driver	
Communications software	Bürkert Communicator (“Accessories”)	

## 10.8 Pneumatic data

Control medium	Neutral gases, air Quality classes in accordance with DIN ISO 8573-1
Dust content	Class 7, max. particle size 40 µm, max. particle density 10 mg/m <sup>3</sup>
Water content	Class 3, max. pressure dew point - 20 °C or min. 10 degrees below the lowest operating temperature
Oil content	Class X, max. 25 mg/m <sup>3</sup>
Temperature range of compressed air	0 – +60 °C
Pressure range	1.4 – 7 bar
Air flow rate	95 l <sub>N</sub> / min (at 1.4 bar*) for aeration and deaeration 150 l <sub>N</sub> / min (at 6 bar*) for aeration and deaeration (Q <sub>N0</sub> = 100 l <sub>N</sub> / min (according to definition for pressure drop from 7 to 6 bar absolute)).
Connections	Internal thread G1/4"

---

\* Pressure specifications: Overpressure with respect to atmospheric pressure

## 10.9 Safety end positions after failure of the electrical or pneumatic auxiliary power

The safety end position depends on the pneumatic connection of the actuator to the working connections A1 or A2.

Actuator system	Designation	Safety end positions after failure of the	
		electrical auxiliary power	pneumatic auxiliary power
	single-acting Control function A	down → Connection according to "Fig. 9"	down
		up → Connection according to "Fig. 10"	
	single-acting control function B	up → Connection according to "Fig. 9"	up
		down → Connection according to "Fig. 10"	
	double-acting Control function I	connection see "Fig. 11"	not defined
		up = lower chamber of the actuator to A2	
		down = upper chamber of the actuator to A2	

Table 8: Safety end position

Pneumatic connection: Description for "Table 8"

Single-acting actuators Control function A and B	Double-acting actuators Control function I
<p>Connection: working connection A1 to actuator A2 sealing</p>	<p>Connection: working connection A2 to actuator A1 sealing</p>
<p>Connection: Working connection A1 and A2 to actuator</p> <p>Safety end position: up = lower chamber to A2 down = upper chamber to A2</p>	

Fig. 9: Connection A1

Fig. 10: Connection A2

Fig. 11: Connection with CFI

## 10.10 Factory settings

The factory settings can be found in Chapter “[27 Operating structure and factory settings](#)”, page 169.

The factory presets are highlighted in blue to the right of the menu in the operating structure.

Examples:

Representation	Description
<input checked="" type="radio"/>	Menu options activated or selected at the factory
<input checked="" type="checkbox"/>	
<input type="radio"/>	Menu options not activated or selected at the factory
<input type="checkbox"/>	
2.0 %	Values set at the factory
10.0 sec /...	

Table 9: Illustration of the factory settings

## 11 ACCESSORIES

Designation	Order no.
USB Interface for serial communication	227 093
Communicator	Information at <a href="http://www.burkert.com">www.burkert.com</a>

Table 10: Accessories

Other accessories can be found on the data sheet for Type 8792/8793.

[www.burkert.com](http://www.burkert.com)

### 11.1 Communications software

The PC operating program “Communicator” is designed for communication with the devices from the Bürkert positioner family. Devices constructed since August 2014 support the full range of functions. If you have any questions regarding compatibility, please contact the Bürkert Sales Center.

## 12 ATTACHMENT AND ASSEMBLY



The dimensions of the Type 8792/8793 and the different device versions can be found on the data sheet.

### 12.1 Safety instructions



#### **WARNING!**

**Risk of injury from improper installation.**

- ▶ Installation may be carried out by authorised technicians only and with the appropriate tools.

**Risk of injury from unintentional activation of the system and an uncontrolled restart.**

- ▶ Secure system from unintentional activation.
- ▶ Following assembly, ensure a controlled restart.

## 12.2 Attachment to a continuous valve with linear actuators according to NAMUR

The valve position is transferred to the position sensor installed in the positioner via a lever (according to NAMUR).

### 12.2.1 Attachment kit for linear actuators (article no. 787215)

(Can be purchased as an accessory from Bürkert).

Part no.	Quantity	Name
1	1	NAMUR mounting bracket IEC 534
2	1	Hoop
3	2	Clamping piece
4	1	Driver pin
5	1	Conical roller
6a	1	NAMUR lever for stroke range 3 – 35 mm
6b	1	NAMUR lever for stroke range 35 – 130 mm
7	2	U-bolt
8	4	Hexagon bolt DIN 933 M8 x 20
9	2	Hexagon bolt DIN 933 M8 x 16
10	6	Circlip DIN 127 A8
11	6	Washer DIN 125 B8.4
12	2	Washer DIN 125 B6.4
13	1	Spring VD-115E 0.70 x 11.3 x 32.7 x 3.5
14	1	Spring washer DIN 137 A6
15	1	Locking washer DIN 6799 - 3.2
16	3	Circlip DIN 127 A6
17	3	Hexagon bolt DIN 933 M6 x 25
18	1	Hexagon nut DIN 934 M6
19	1	Square nut DIN 557 M6
21	4	Hexagon nut DIN 934 M8
22	1	Guide washer 6.2 x 9.9 x 15 x 3.5

Table 11: Attachment kit for linear actuators

## 12.2.2 Installation

### **WARNING!**

Risk of injury from improper installation.

- ▶ Installation may be carried out by authorised technicians only and with the appropriate tools.

Risk of injury from unintentional activation of the system and an uncontrolled restart.

- ▶ Secure system from unintentional activation.
- ▶ Following assembly, ensure a controlled restart.

#### Procedure:

- Using the clamping pieces (3), hexagon bolts (17) and circlips (16) attach the hoop (2) to the actuator spindle.

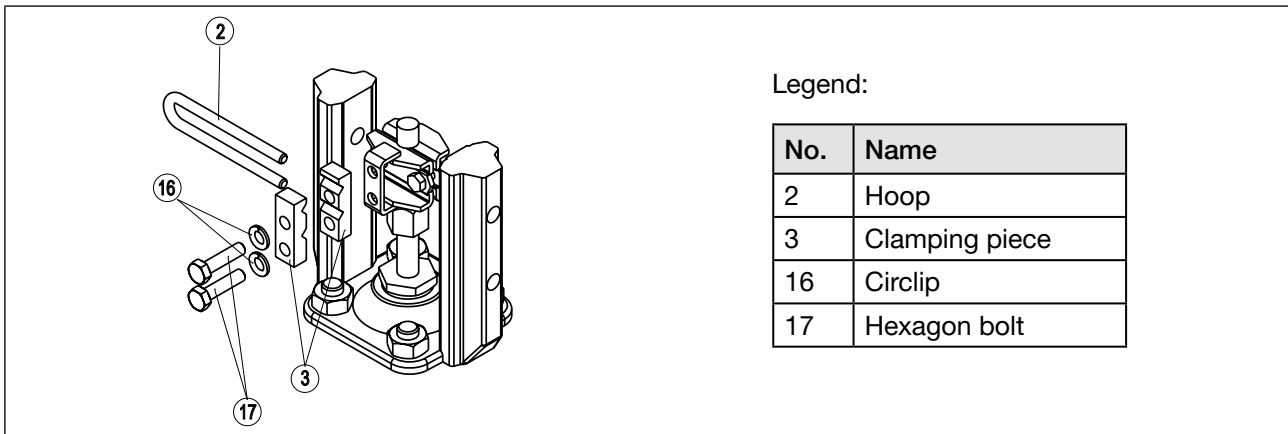


Fig. 12: Attaching the hoop

- Select short or long lever according to the stroke of the actuator (see “[Table 11: Attachment kit for linear actuators](#)”).
- Assemble lever (if not pre-assembled) (see “[Fig. 13](#)”).

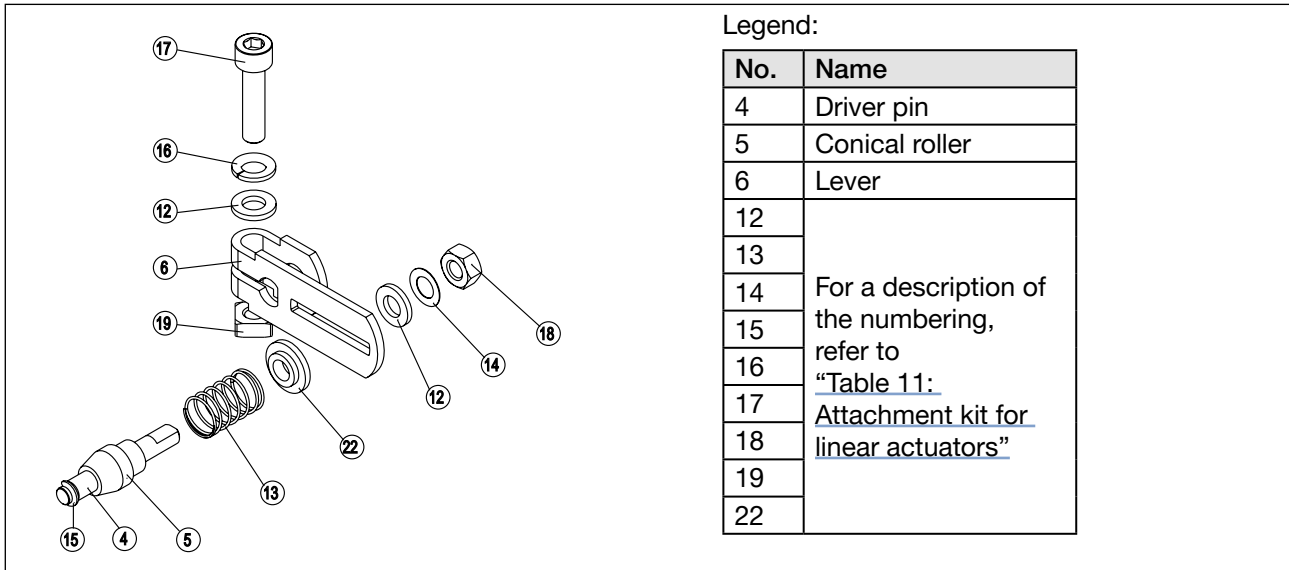


Fig. 13: Assembling the lever

**!** The gap between the driver pin and the shaft should be the same as the actuator stroke. As a result, the lever has an angular range of 60°. (see "Fig. 14").

**Angular range of the position sensor:**

The maximum angular range of the position sensor is 150°.

**Rotational range of the lever:**

To ensure that the position sensor operates at a good resolution, the rotational range of the lever must be at least 30°.

The rotational movement of the lever must be within the position sensor rotation range of 150°.

The scale printed on the lever is not relevant.

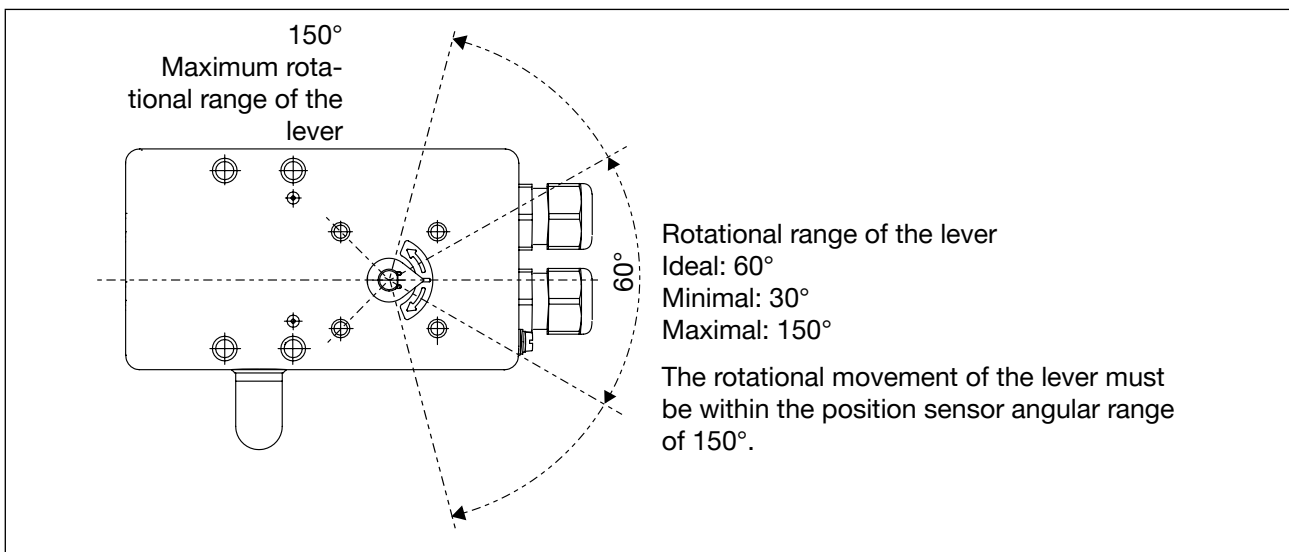


Fig. 14: Angular range of the lever

→ Attach lever to the shaft of the Type 8792/8793 and screw tight.



### 12.2.3 Attaching mounting bracket

→ Attach mounting bracket ① to the back of the Type 8792/8793 with hexagon bolts ⑨, circlip ⑩ and washers ⑪ (see “Fig. 15”).

**!** The selection of the M8 thread used on the Type 8792/8793 depends on the size of the actuator.

→ To determine the correct position, hold the Type 8792/8793 with mounting bracket on the actuator.

The conical roller ⑤ on the lever ⑥ of the position sensor must be able to move freely in the hoop (refer “Fig. 15”) along the entire stroke range of the actuator.

At 50% stroke the lever position should be approximately horizontal (see chapter “12.2.4 Aligning lever mechanism”).

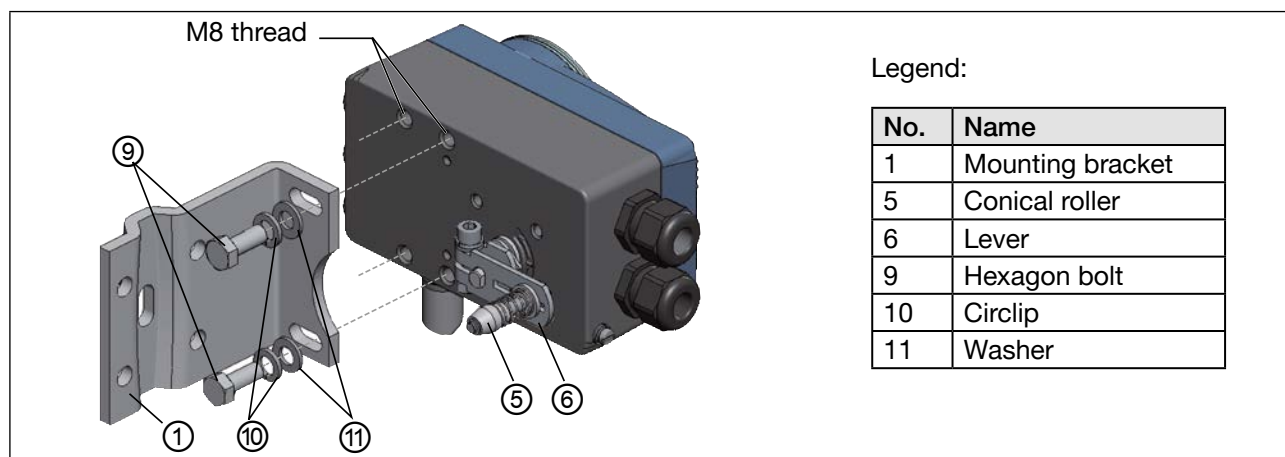


Fig. 15: Attaching mounting bracket

#### Attaching the Type 8792/8793 with mounting bracket for actuators with cast frame:

→ Attach mounting bracket to the cast frame with one or more hexagon bolts ⑧, washers ⑪ and circlips ⑩ (see “Fig. 16”).

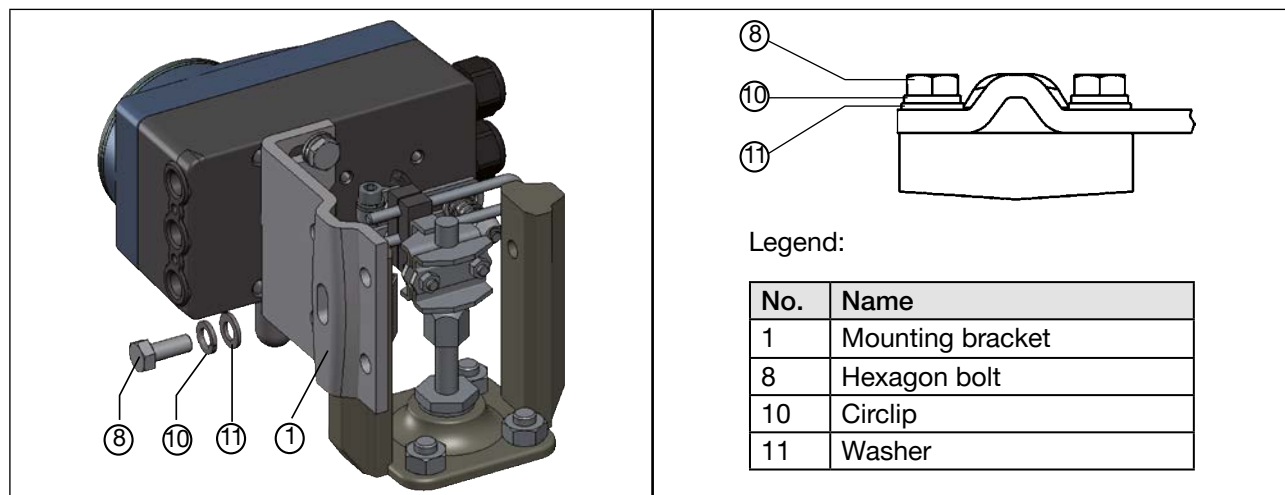


Fig. 16: Attach Type 8792/8793 with mounting bracket; for actuators with cast frame

**Attaching the Type 8792/8793 with mounting bracket for actuators with columnar yoke:**

→ Attach mounting bracket to the columnar yoke with the U-bolt (7), washers (11), circlips (10) and hexagon nuts (21) (see “Fig. 17”).

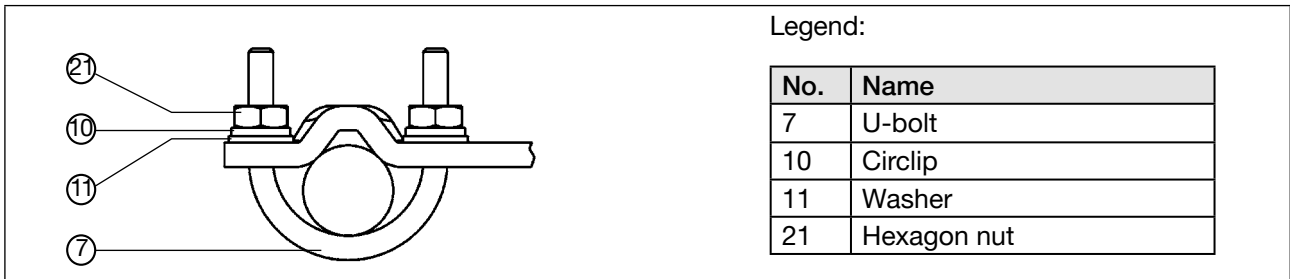


Fig. 17: Attach Type 8792/8793 with mounting bracket; for actuators with columnar yoke

### 12.2.4 Aligning lever mechanism



The lever mechanism cannot be correctly aligned until the device has been connected electrically and pneumatically.

- Move the actuator in manual mode to half stroke (according to the scale on the actuator).
- Adjust the height of the Type 8792/8793 until the lever is horizontal.
- Fix the Type 8792/8793 in this position on the actuator.

## 12.3 Attachment to a continuous valve with rotary actuator

The shaft of the position sensor integrated in the positioner is connected directly to the shaft of the rotary actuator.

### 12.3.1 Mounting kit (VDI/VDE 3845) on rotary actuator (article no. 787338)

(Can be purchased as an accessory from Bürkert).

Part no.	Quantity	Name
1	1	Adapter
2	2	Setscrew DIN 913 M4 x 10
3	4	Cheese-head screw DIN 933 M6 x 12
4	4	Circlip B6
5	2	Hexagon nut DIN985, M4

Table 12: Mounting kit on rotary actuator

#### Other accessories:

The order number for the assembly bridge with fastening screws (according to VDI/VDE 3845) can be found on the data sheet for Type 8792/8793.

### 12.3.2 Installation



#### WARNING!

**Risk of injury from improper installation.**

- ▶ Installation may be carried out by authorised technicians only and with the appropriate tools.

**Risk of injury from unintentional activation of the system and an uncontrolled restart.**

- ▶ Secure system from unintentional activation.
- ▶ Following assembly, ensure a controlled restart.

#### Procedure:

- Specify the attachment position of the Type 8792/8793:
  - parallel to the actuator or
  - rotated by 90° to the actuator.
- Determine home position and direction of rotation of the actuator.
- Connect adapter to the shaft of the Type 8792/8793 and secure with 2 setscrews.



**Anti-twist safeguard:**

**Note the flat side of the shaft!**

One of the setscrews must be situated on the flat side of the shaft as an anti-twist safeguard (see "Fig. 18").

**Rotational range of the position sensor:**

The maximum rotational range of the position sensor is 150°.

The shaft of the Type 8792/8793 may be moved within this range only.

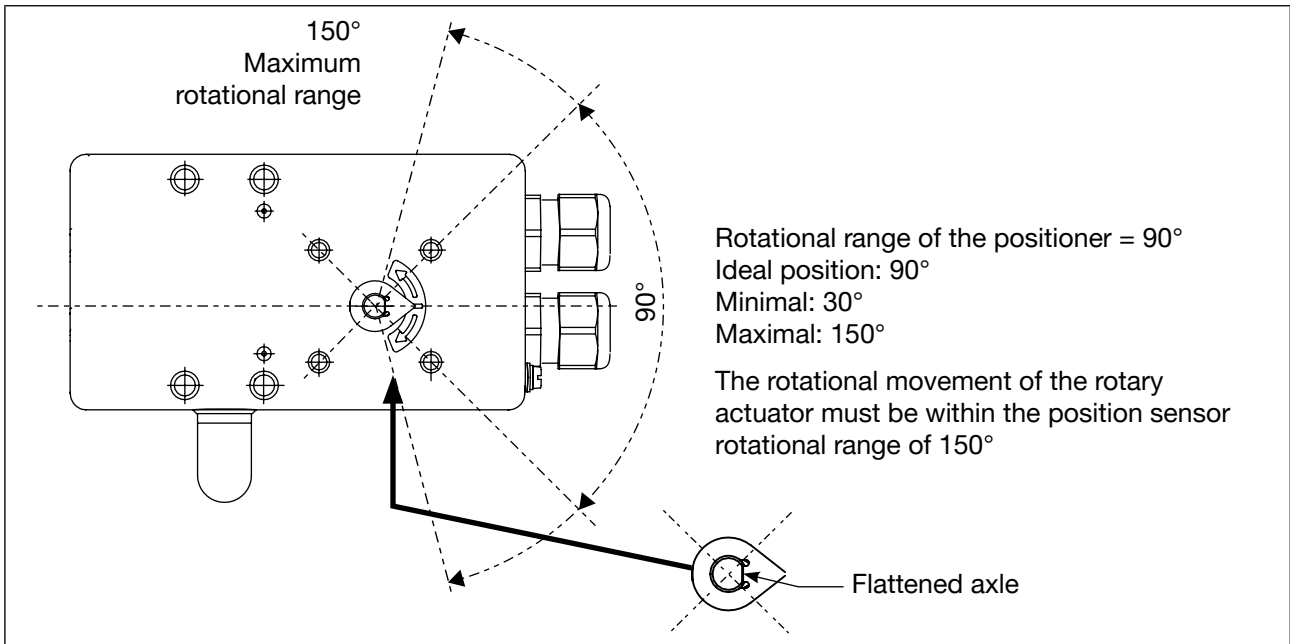


Fig. 18: Rotational range / anti-twist safeguard

→ Assemble the multi-part assembly bridge\* suitable for the actuator.

→ Attach the assembly bridge to the Type 8792/8793 using 4 cheese-head screws ③ and circlips ④ (see "Fig. 19").

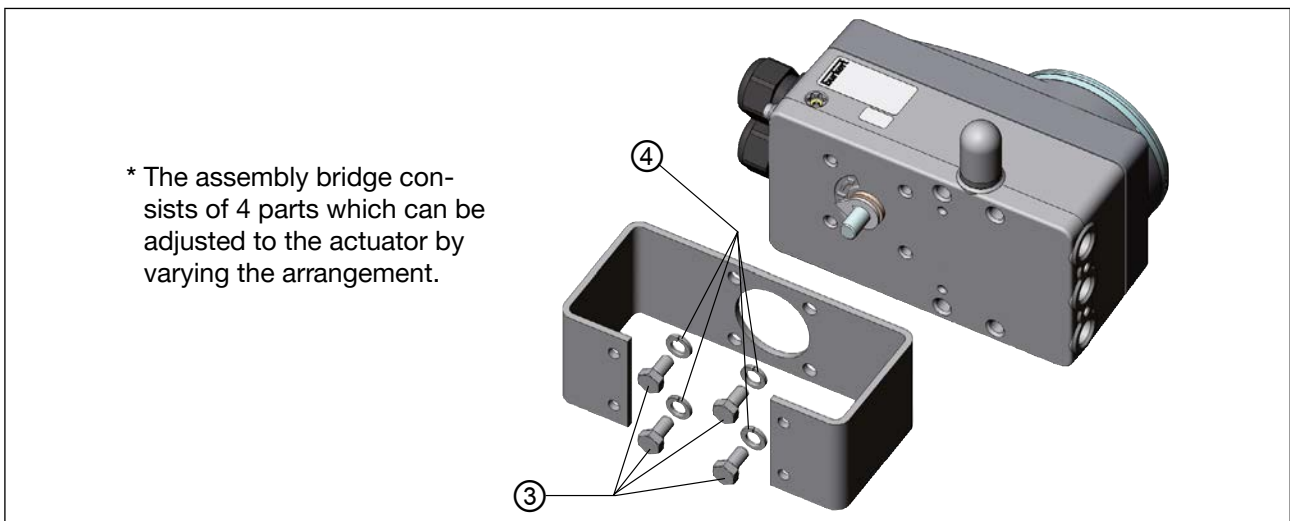


Fig. 19: Attach assembly bridge (schematic representation)

→ Place Type 8792/8793 with assembly bridge on the rotary actuator and attach (see “Fig. 20”)

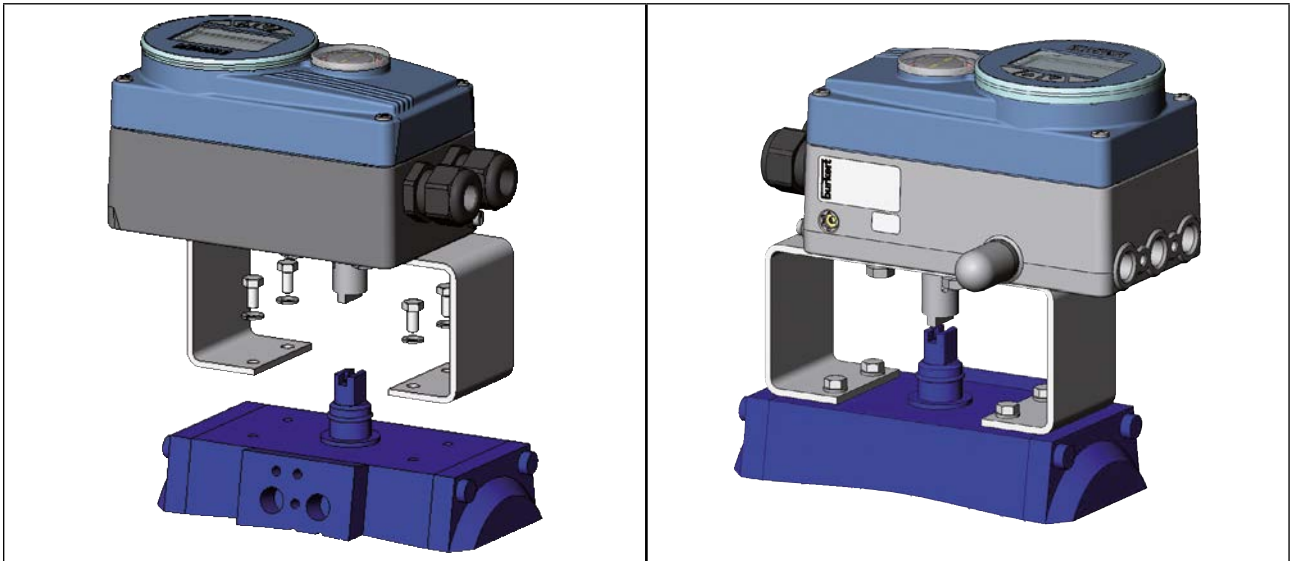


Fig. 20: Rotary actuator attachment



If the X.TUNE ERROR 5 message is indicated on the graphics display after the X.TUNE function starts, the shaft of the Type 8792/8793 is not correctly aligned with the shaft of the actuator (see “Table 112: Error and warning message on X.TUNE”, page 200).

- Check alignment (as described previously in this chapter).
- Then repeat the X.TUNE function.

## 12.4 Remote operation with external position sensor

In the case of this model, the positioner has no position sensor in the form of a rotary position sensor, but an external position sensor.

Depending on the model of Type 8792/8793, there are the following connection options:

Device type	Interface	Position sensor	Setting in the menu (ADD.FUNCTION)
Type 8792 Remote	digital (serial)	Remote Sensor Type 8798	–
Type 8793 Remote	digital (serial)	Remote Sensor Type 8798	<i>POS.SENSOR</i> → <i>DIGITAL</i> For menu description see “26.2.19”
	analog (4...20 mA) *	Any, high-resolution position sensor	<i>POS.SENSOR</i> → <i>ANALOG</i> For menu description see “26.2.19”

Table 13: Connection options of position sensor



\* If the position sensor is connected to the process controller Type 8793 via the analog interface, it can be operated only as a positioner.

### 12.4.1 Mounting accessories

There are two options of attaching the Type 8792/8793 in remote operation (see “Fig. 21”).

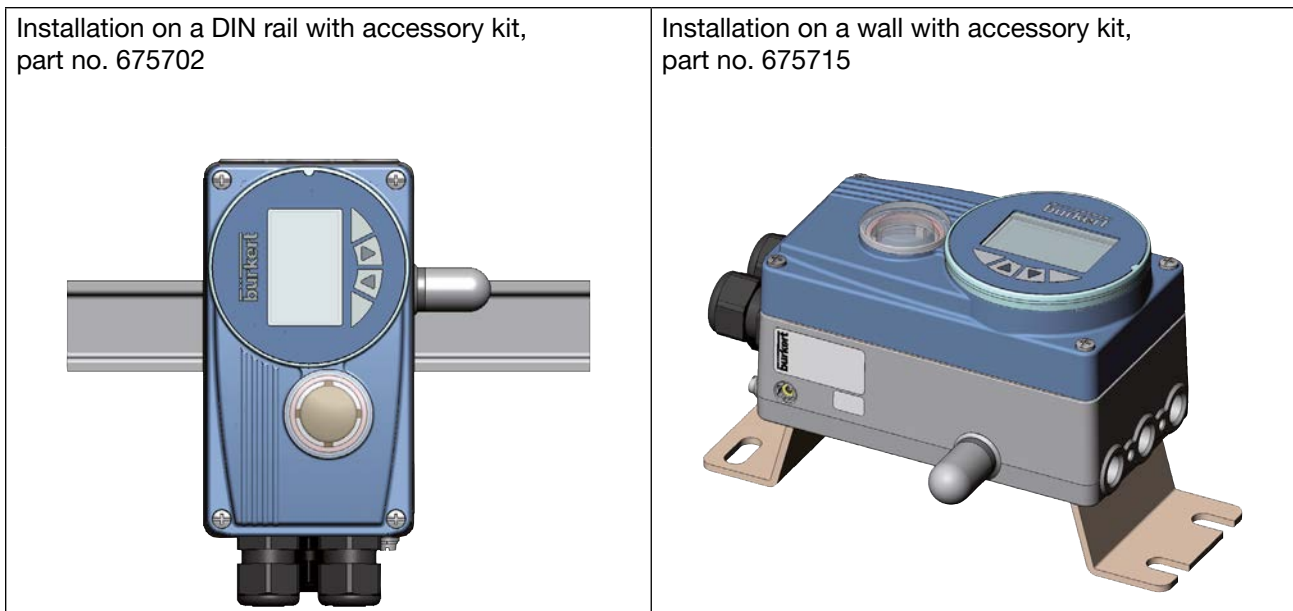


Fig. 21: Attachment types in remote operation

## 12.4.2 Connection and start-up of the Remote Sensor Type 8798



### WARNING!

Risk of injury from improper start-up.

- ▶ Start-up may be carried out by authorised technicians only and with the appropriate tools.

Risk of injury from unintentional activation of the system and an uncontrolled restart.

- ▶ Secure system from unintentional activation.
- ▶ Following assembly, ensure a controlled restart.

→ Connect the 3 or 4 wires of the sensor cable to the designated screw-type terminals of type 8792/8793.

**Connection of screw-type terminals:** See chapter [“15.2.4 Terminal assignment for external position sensor \(for remote model only\)”](#), page 59.

**Connection of M8 circular connector (only for PROFIBUS):** See chapter PROFIBUS [“30”](#).

→ Attach Remote Sensor on the actuator.

The correct procedure is described in the brief instructions for the Remote Sensor.

→ Connect compressed air to Type 8792/8793.

→ Connect Type 8792/8793 pneumatically to the actuator.

→ Switch on operating voltage to the Type 8792/8793.

→ Run the *X.TUNE* function.

### 12.4.3 Connection and start-up via a 4 – 20 mA position sensor (for Type 8793 remote model only)



When a 4 – 20 mA position sensor is connected, the process controller Type 8793 can be used as a positioner only, as the process actual value input is used as input for the position sensor.

In principle, any position sensor with a 4 – 20 mA output can be connected which has an adequate resolution of the path signal.

Good control properties are obtained if the resolution of the position sensor allows at least 1000 measuring steps over the path to be measured.

Example: Position sensor with 150 mm measurement range  
Of which used measurement range (= stroke) 100 mm

Required minimum resolution of the sensor:

$$\frac{100 \text{ mm}}{1000 \text{ Steps}} = 0.1 \text{ mm}$$



#### **WARNING!**

##### **Risk of injury from improper start-up.**

- ▶ Start-up may be carried out by authorised technicians only and with the appropriate tools.

##### **Risk of injury from unintentional activation of the system and an uncontrolled restart.**

- ▶ Secure system from unintentional activation.
- ▶ Following assembly, ensure a controlled restart.

Connect 4 – 20 mA position sensor to the terminals 1 - 4 of the process controller Type 8793 remote model.

(see “[Table 22: Terminal assignments of the process actual value input](#)”, page 60)

Internal supply of the position sensor by Type 8793:

→ Connection according to input type “4...20 mA - internally supplied”

Separate supply of the position sensor:

→ Connection according to input type “4...20 mA - externally supplied”.

→ Attach remote sensor on the actuator.

The correct procedure is described in the instructions for the position sensor.

→ Connect compressed air to the Type 8793.

→ Connect Type 8793 pneumatically to the actuator

→ Switch on Type 8793 operating voltage.

→ To obtain the best possible control precision, adjust the position sensor so that path to be measured corresponds to the signal range 4 – 20 mA (only if the position sensor includes this function).

→ In the *ADD.FUNCTION* menu activate the *POS.SENSOR* function. Then select *POS.SENSOR* in the main menu and set *ANALOG*. (see chapter “[26.2.19](#)”.

→ Run the *X.TUNE* function.



## 13 PNEUMATIC CONNECTION

### 13.1 Safety instructions



#### **DANGER!**

Risk of injury from high pressure in the equipment.

- ▶ Before loosening the pneumatic lines and valves, turn off the pressure and vent the pneumatic lines.



#### **WARNING!**

Risk of injury from improper installation.

- ▶ Installation may be carried out by authorized technicians only and with the appropriate tools.

Risk of injury from unintentional activation of the system and an uncontrolled restart.

- ▶ Secure system from unintentional activation.
- ▶ Following installation, ensure a controlled restart.

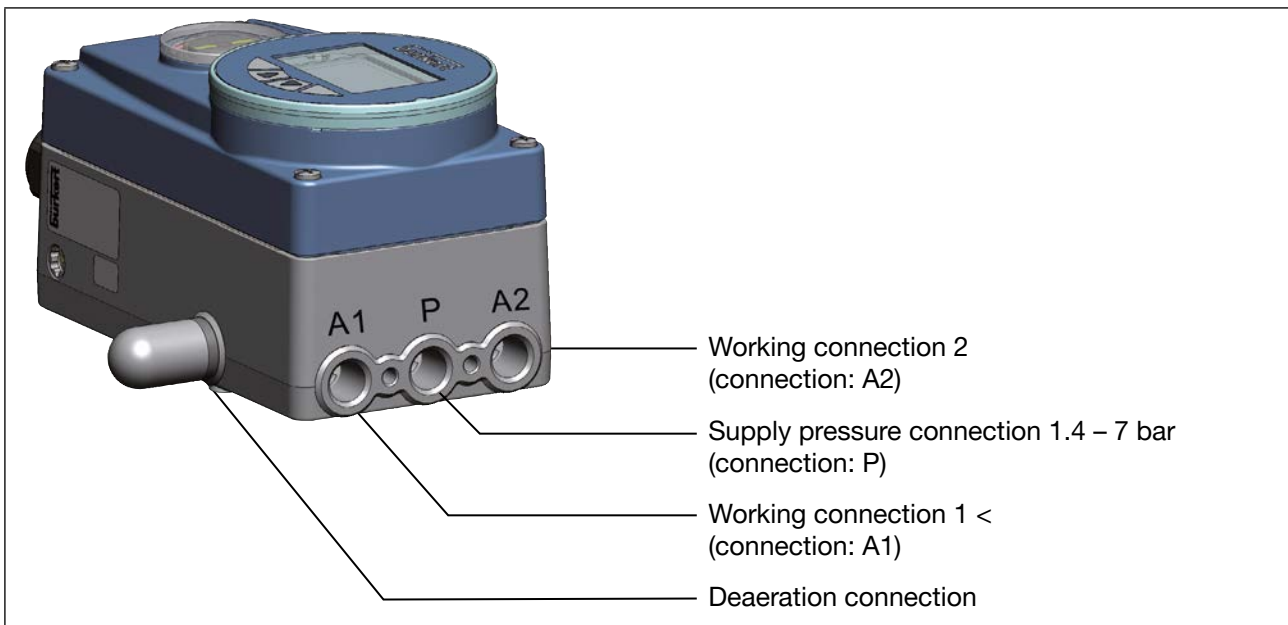


Fig. 22: Fluid installation / Location of the connections

**Procedure:**

→ Apply supply pressure (1.4 – 7 bar) to the supply pressure connection P.

**For single-acting actuators (control function A and B):**

→ Connect one working connection (A1 or A2, depending on required safety position) to the chamber of the single-acting actuator.

Safety positions see chapter [“10.9 Safety end positions after failure of the electrical or pneumatic auxiliary power”](#).

→ Seal a working connection which is not required with a plug.

**For double-acting actuators (control function I):**

→ Connect working connections A1 and A2 to the respective chambers of the double-acting actuator see chapter [“10.9 Safety end positions after failure of the electrical or pneumatic auxiliary power”](#).



**Important information for perfect control behaviour.**

This ensures that the control behaviour is not extremely negatively affected in the upper stroke range on account of too little pressure difference.

→ keep the applied supply pressure at least 0.5 – 1 bar above the pressure which is required to move the pneumatic actuator to its end position.

If fluctuations are greater, the control parameters measured with the *X.TUNE* function are not optimum.

→ during operation keep the fluctuations of the supply pressure as low as possible (max.  $\pm 10\%$ ).

## 14 ELECTRICAL CONNECTION - CIRCULAR PLUG-IN CONNECTOR



### DANGER!

Risk of injury due to electrical shock.

- ▶ Before reaching into the device or the equipment, switch off the operating voltage and secure to prevent reactivation.
- ▶ Observe applicable accident prevention and safety regulations for electrical equipment.



### WARNING!

Risk of injury from improper installation.

- ▶ Installation may be carried out by authorized technicians only and with the appropriate tools.

Risk of injury from unintentional activation of the system and an uncontrolled restart.

- ▶ Secure system from unintentional activation.
- ▶ Following installation, ensure a controlled restart.



### Using the 4 – 20 mA set-point value input

If several devices of Type 8792/8793 are connected in series and the power supply to a device in this series connection fails, the input of the failed device becomes highly resistive. As a result, the 4 – 20 mA standard signal fails. In this case please contact Bürkert Service directly.

### If PROFIBUS DP:

The designation of the circular plug-in connectors and sockets and the contacts can be found in the respective chapters.

### 14.1 Type 8792 - designation of the circular plug-in connectors

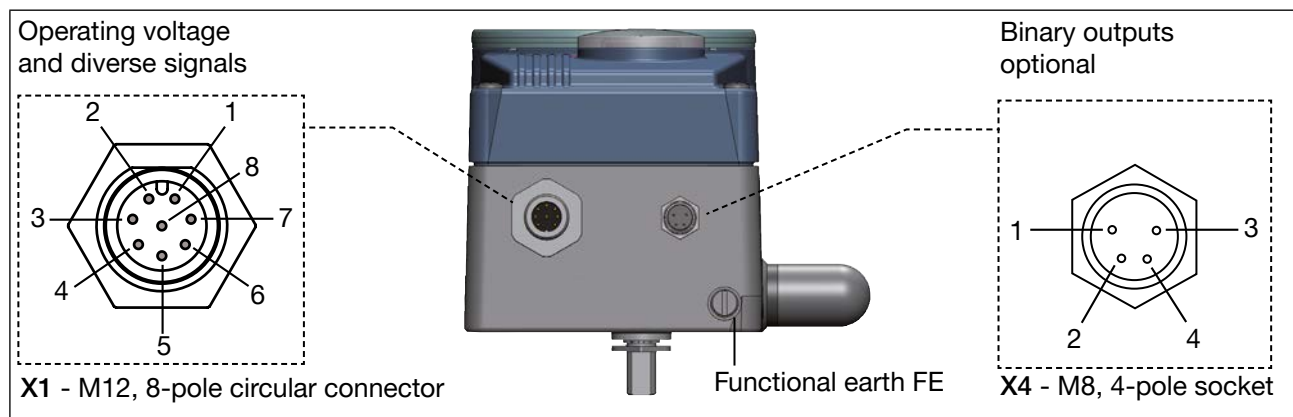



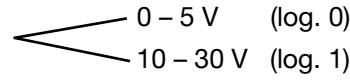







Fig. 23: Type 8792; designation of the circular plug-in connectors and contacts

## 14.2 Connection of the positioner Type 8792

→ Connect pins according to the model (options) of the positioner.

### 14.2.1 X1 - M12, 8-pole circular connector

Pin	Wire colour*	Configuration	On the device side	External circuit / Signal level
<b>Input signals of the control centre (e.g. PLC)</b>				
1	white	Set-point value + (0/4 – 20 mA or 0 – 5/10 V)	1 	+ (0/4 – 20 mA or 0 – 5/10 V) completely galvanically isolated
2	brown	Set-point value GND	2 	GND set-point value
5	grey	Binary input	5 	+ 
6	pink	Binary input GND	6 	GND (identical with the GND operating voltage)
<b>Output signals to the control centre (e.g. PLC) - (only used for analog output option)</b>				
8	red	Analogue feedback +	8 	+ (0/4 – 20 mA or 0 – 5/10 V) completely galvanically isolated
7	blue	Analogue feedback GND	7 	GND Analogue feedback
<b>Operating voltage</b>				
3	green	GND	3 	24 V DC ± 10% max. residual ripple 10%
4	yellow	+24 V	4 	

\* The indicated wire colours refer to the connection cable, part no. 919267, available as an accessory.

Table 14: Pin assignment; X1 - M12, 8-pole circular connector

### 14.2.2 X4 - M8, 4-pole socket (for binary outputs option only) Output signals to the control centre (e.g. PLC)




Pin	Configuration	On the device side	External circuit / Signal level
1	Binary output 1	1 	0 – 24 V
2	Binary output 2	2 	0 – 24 V
3	Binary output GND	3 	GND (identical with the GND operating voltage)

Table 15: Pin assignment; X4 - M8, 4-pole socket - output signals to the control centre

When the operating voltage is applied, the positioner is operating.

→ Now make the required basic settings and actuate the automatic adjustment of the positioner. The procedure is described in chapter “21 Start-up”.

### 14.3 Type 8793 - designation of the circular plug-in connectors and contacts

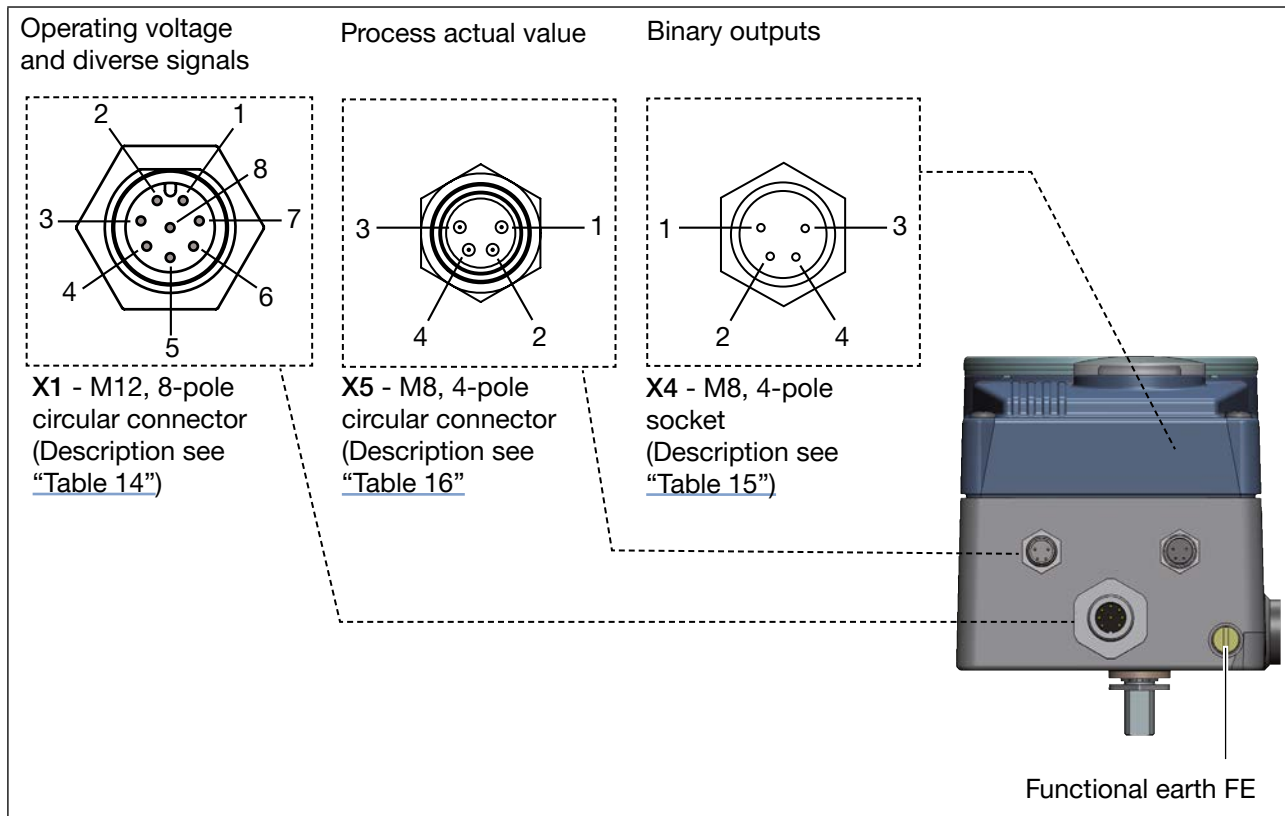


Fig. 24: Type 8793; designation of the circular plug-in connectors and contacts

#### Location of the switch:

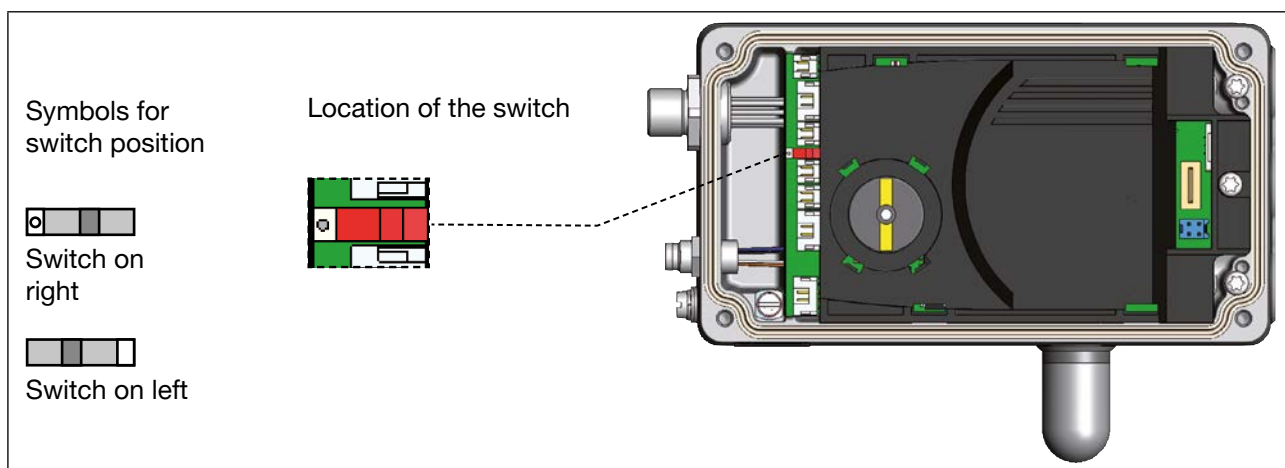



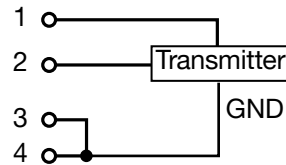

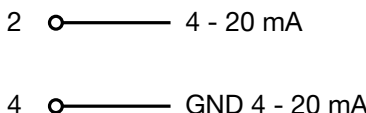

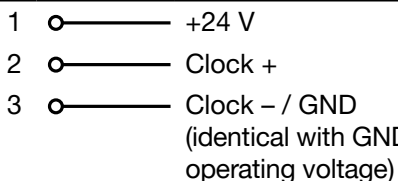

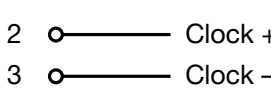

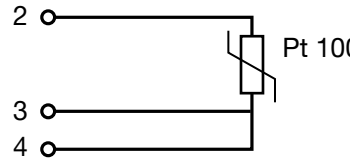
Fig. 25: Location of the switch; symbols for switch position

MAN 1000118577 EN Version: K Status: RL (released | freigegeben) printed: 05.08.2022

## 14.4 Connecting the process controller Type 8793

→ First connect the process controller as described in chapter “14.2 Connection of the positioner Type 8792”.

### 14.4.1 X5 - M8, 4-pole circular connector, plug assignments of the process actual value input

Input type*	Pin	Wire colour**	Configuration	DIP switches	On the device side	External circuit
4 – 20 mA-internally supplied	1 2 3 4	brown white blue black	+24 V transmitter supply Output from transmitter GND (identical with GND operating voltage) Bridge to GND (Pin 3)	 Switch on left		
4 – 20 mA-externally supplied	1 2 3 4	brown white blue black	not used Process actual + not used Process actual -	 Switch on right		
Frequency-internally supplied	1 2 3 4	brown white blue black	+24 V sensor supply Clock input + Clock input - (GND) not used	 Switch on left		
Frequency-externally supplied	1 2 3 4	brown white blue black	not used Clock input + Clock input - not used	 Switch on right		
Pt 100 (see information below)	1 2 3 4	brown white blue black	not used Process actual 1 (power supply) Process actual 3 (GND) Process actual 2 (compensation)	 Switch on right		

\* Can be adjusted via software (see chapter “21 Start-up”).

\*\* The indicated colors refer to the connection cable available as an accessory (918718).

Table 16: Pin assignment; X5 - M8, 4-pole circular connector - process actual value input



Connect the Pt 100 sensor via 3 cables for cable compensation reasons. It is essential to bridge terminal 3 and terminal 4 on the sensor.

When the operating voltage is applied, the process controller is operating.

→ Now make the required basic settings and actuate the automatic adjustment of the process controller. The procedure is described in chapter “21 Start-up”.

# 15 ELECTRICAL CONNECTION - CABLE GLAND

## DANGER!

Risk of injury due to electrical shock.

- ▶ Before reaching into the device or the equipment, switch off the operating voltage and secure to prevent reactivation.
- ▶ Observe applicable accident prevention and safety regulations for electrical equipment.

## WARNING!

Risk of injury from improper installation.

- ▶ Installation may be carried out by authorized technicians only and with the appropriate tools.

Risk of injury from unintentional activation of the system and an uncontrolled restart.

- ▶ Secure system from unintentional activation.
- ▶ Following installation, ensure a controlled restart.

## Using the 4 – 20 mA set-point value input

If several devices of Type 8792/8793 are connected in series and the power supply to a device in this series connection fails, the input of the failed device becomes highly resistive. As a result, the 4 – 20 mA standard signal fails. In this case please contact Bürkert Service directly.

## 15.1 Connection board of the Type 8792/8793 with screw-type terminals

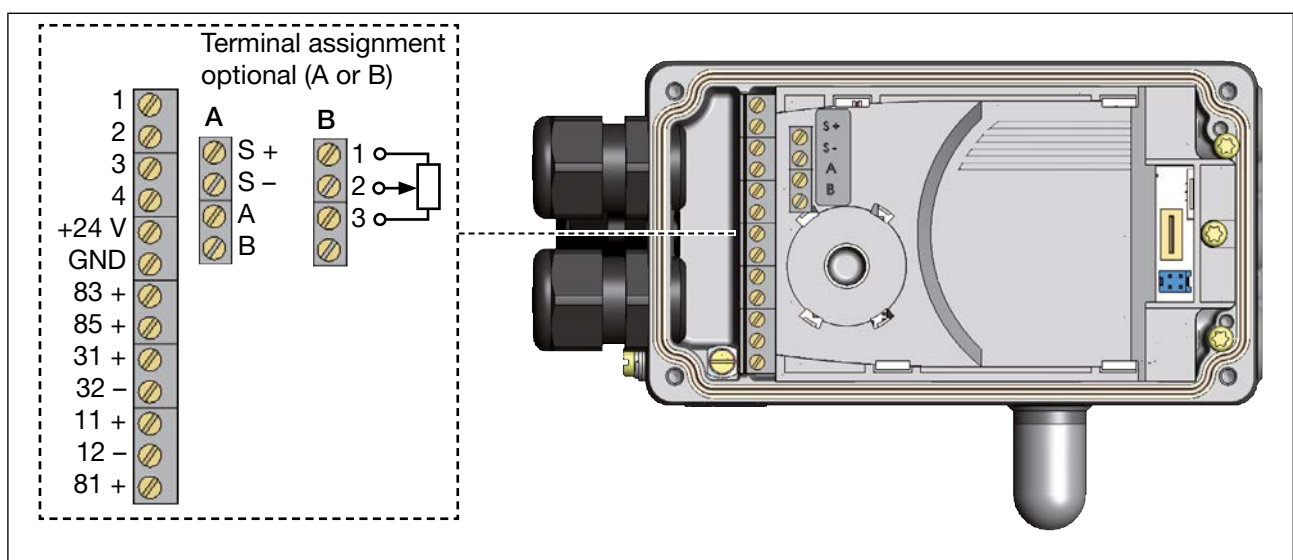


Fig. 26: Designation of the screw-type terminals

Procedure:

→ Unscrew the 4 screws on the housing cover and remove the cover.  
The screw-type terminals are now accessible.

→ Connect Type 8792/8793.

The procedure is described in the following chapters.

for Type 8792: chapter “[15.2 Terminal assignment for cable gland - positioner Type 8792](#)”

for Type 8793: chapter “[15.3 Terminal assignment for cable gland - process controller Type 8793](#)”

## 15.2 Terminal assignment for cable gland - positioner Type 8792

### 15.2.1 Input signals from the control centre (e.g. PLC)




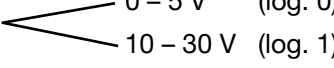
Terminal	Configuration	On the device side	External circuit / Signal level
11 +	Set-point value +	11 + 	+ (0/4 – 20 mA or 0 – 5/10 V) completely galvanically isolated
12 –	Set-point value GND	12 – 	GND set-point value
81 +	Binary input +	81 + 	+  specific to operating voltage GND (terminal GND)

Table 17: Terminal assignment; input signals of the control centre

### 15.2.2 Output signals to the control centre (e.g. PLC) (required for analogue output and/or binary output option only)

→ Connect terminals according to the model (options) of the positioner.





Terminal	Configuration	On the device side	External circuit / Signal level
83 +	Binary output 1	83 + 	24 V / 0 V, NC / NO specific to operating voltage GND (terminal GND)
85 +	Binary output 2	85 + 	24 V / 0 V, NC / NO specific to operating voltage GND (terminal GND)
31 +	Analogue feedback +	31 + 	+ (0/4 – 20 mA or 0 – 5/10 V) completely galvanically isolated
32 –	Analogue feedback GND	32 – 	GND Analogue feedback

Table 18: Terminal assignment; output signals to the control centre



### 15.2.3 Operating voltage

Terminal	Configuration	On the device side	External circuit / Signal level
+24 V	Operating voltage +	+24 V	
GND	Operating voltage GND	GND	

Table 19: Terminal configuration; operating voltage

### 15.2.4 Terminal assignment for external position sensor (for remote model only)

Connection of the digital, contact-free position sensor Type 8798:

Terminal	Wire colour		Configuration	On the device side	External circuit / Signal level
	Cable type 1	Cable type 2			
S +	brown	brown	Supply sensor +	S +	
S -	white	black	Supply sensor -	S -	
A	green	red	Serial interface, A-line	A	
B	yellow	orange	Serial interface, B-line	B	

Table 20: Terminal assignment; digital, contact-free position sensor Type 8798

Connection of a potentiometric position sensor:

Terminal	Configuration	On the device side	External circuit
	Potentiometer 1	1	
	Wiper 2	2	
	Potentiometer 3	3	

Table 21: Terminal assignment; potentiometric position sensor

When the operating voltage is applied, the positioner is operating.

→ Now make the required basic settings and actuate the automatic adjustment of the positioner. The procedure is described in chapter “21 Start-up”.

## 15.3 Terminal assignment for cable gland - process controller Type 8793

→ First connect the process controller as described in chapter “15.2 Terminal assignment for cable gland - positioner Type 8792”

### 15.3.1 Terminal assignments of the process actual value input

Input type*	Terminal	Configuration	On the device side	External circuit	
4 – 20 mA - internally supplied	actual value	1			
		2			Output from transmitter
		3			Bridge to GND (Terminal GND from operating voltage)
		4			not used
	GND	GND from operating voltage			
4 – 20 mA - externally supplied	actual value	1			
		2	Process actual +	2 ○ ——— + (4 – 20 mA)	
		3	Process actual –	3 ○ ——— GND 4 – 20 mA	
		4	not used		
Frequency - internally supplied	actual value	1			
		2			Clock input +
		3			not used
		4			Clock input –
	GND	GND from operating voltage	GND ○ ——— Clock – (GND)		
Frequency - externally supplied	actual value	1			
		2	Clock input +	2 ○ ——— Clock +	
		3	not used		
		4	Clock input –	4 ○ ——— Clock –	
Pt 100 (see infor- mation below)	actual value	1			
		2			Process actual 1 (Power supply)
		3			Process actual 3 (GND)
		4			Process actual 2 (Compensation)

\* Can be adjusted via software (see chapter “21 Start-up”).

Table 22: Terminal assignments of the process actual value input



Connect the Pt 100 sensor via 3 cables for cable compensation reasons. It is essential to bridge terminal 3 and terminal 4 on the sensor.

When the operating voltage is applied, the process controller is operating.

→ Now make the required basic settings and actuate the automatic adjustment of the process controller. The procedure is described in chapter “21 Start-up”.

## 16 OPERATING LEVELS

There is the process level and the setting level for the operation and setting of type 8792/8793.

### Process level:

The running process is displayed and operated on the process level.

Operating state:     AUTOMATIC     – Displaying the process data  
                           MANUAL     – Manually opening and closing the valve

### Setting level:

The basic settings for the process are made on the setting level.

- Inputting the operating parameters
- Activating auxiliary functions

**!** If the device is in the AUTOMATIC operating state when changing to the setting level, the process continues running during the setting.

### 16.1 Switching between the operating levels

Change to the setting level	<b>MENU</b>	Press for 3 seconds
Return to the process level	<b>EXIT</b>	Press briefly

**!** The set MANUAL or AUTOMATIC operating state is retained even when the operating level is changed.

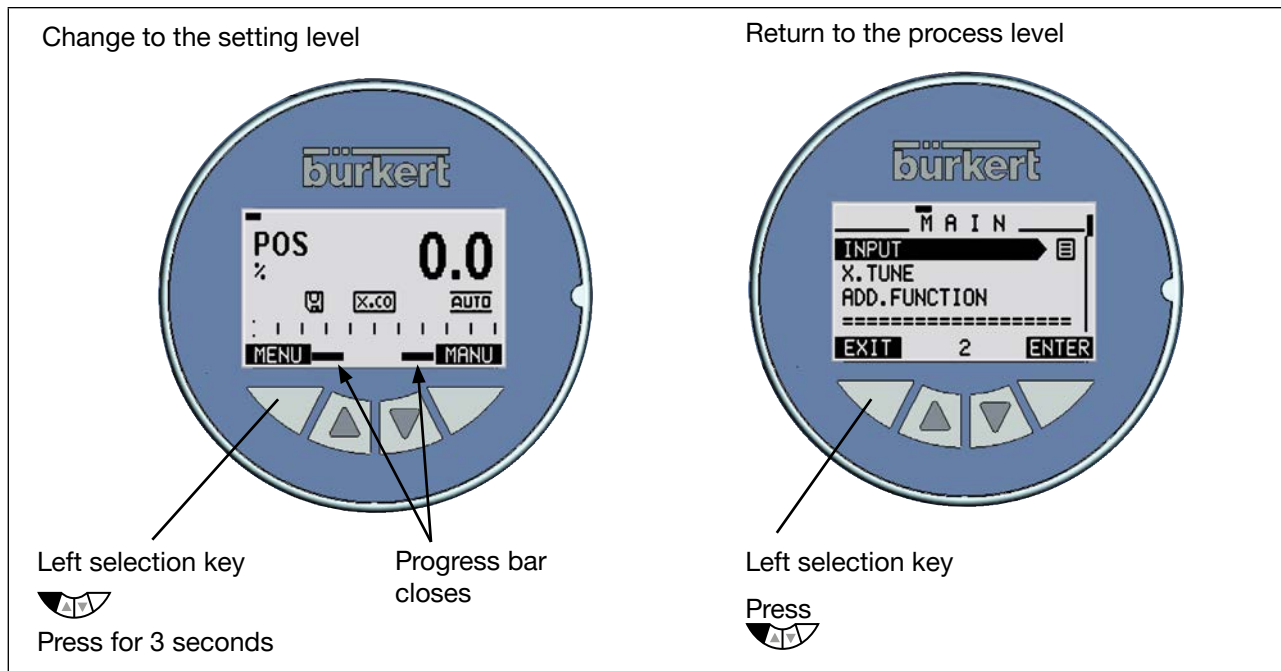


Fig. 27: Changing operating level

## 17 OPERATING AND DISPLAY ELEMENTS

The following chapter describes the operating and display elements of Type 8792/8793.

### 17.1 Description of the operating and display elements

The device is operated by four keys and a 128x64 dot matrix graphics display.

The display is adjusted to the set functions and operating levels.

In principle, a distinction can be made between the display view for the process level and the setting level.

When the operating voltage has been applied, the process level is displayed.

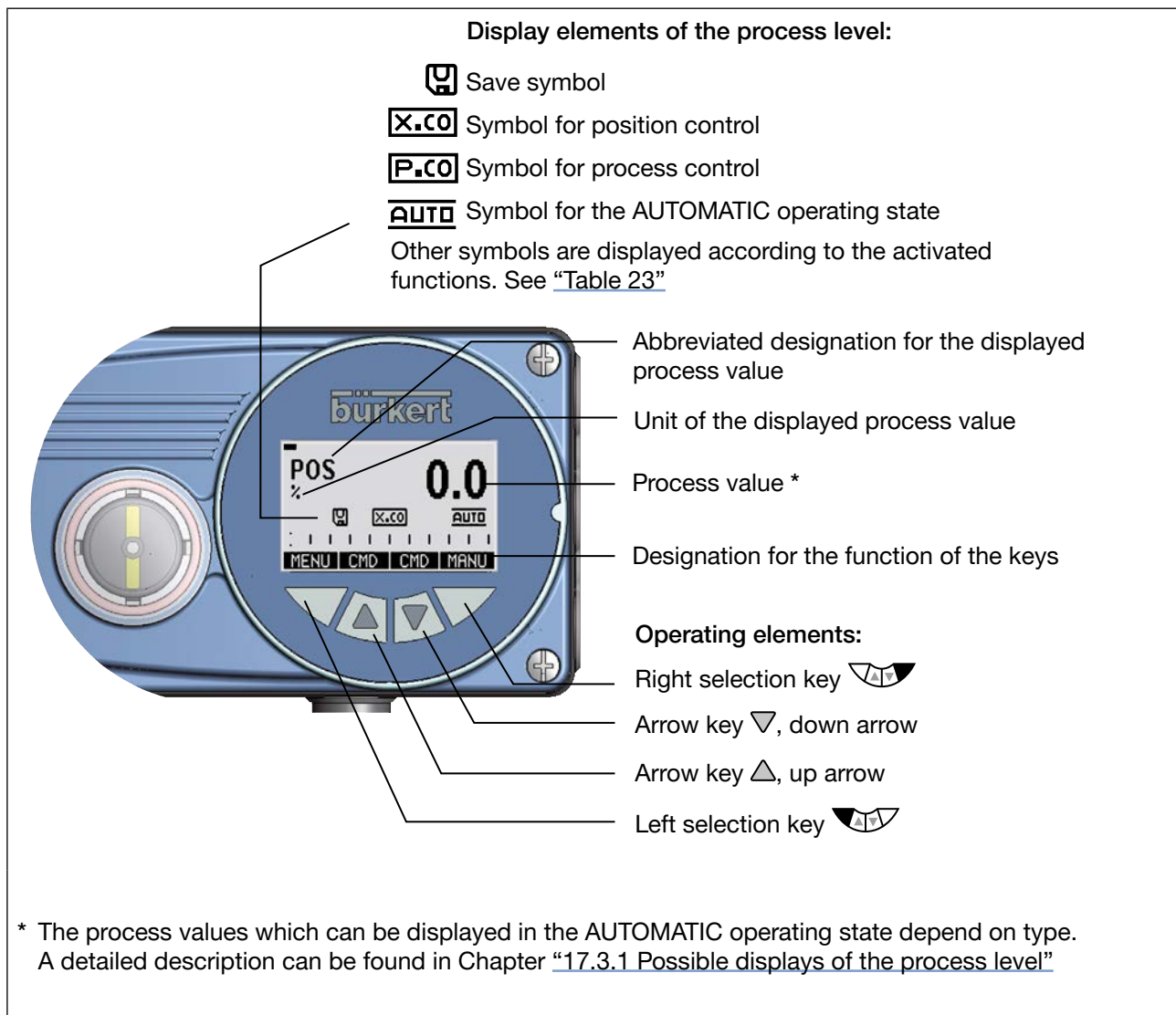


Fig. 28: Display and operating elements of the process level

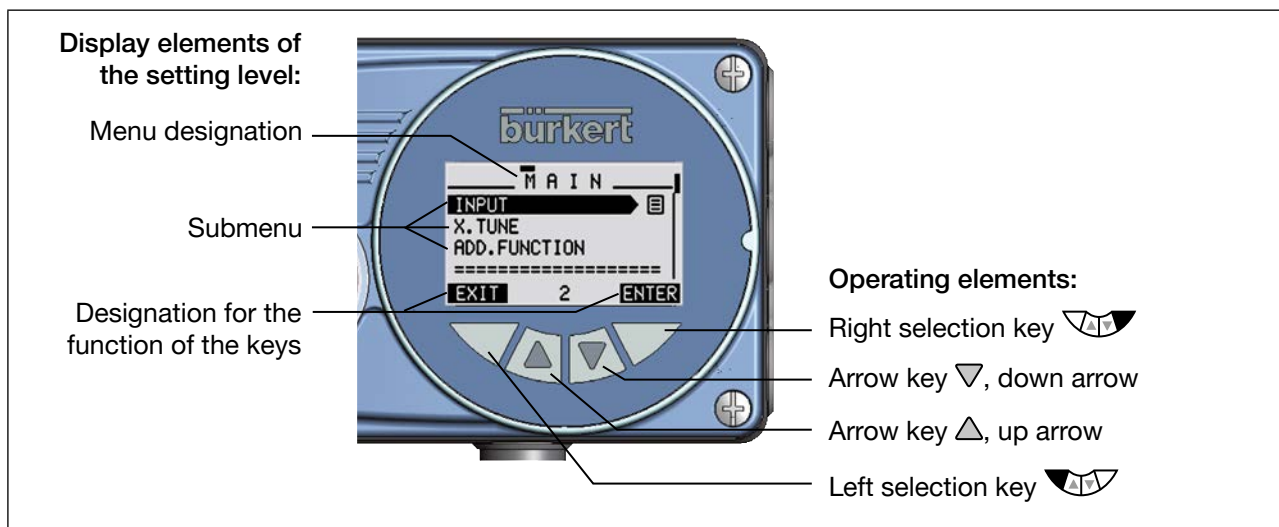


Fig. 29: Display and operating elements of the setting level

### 17.1.1 Description of the symbols which are displayed on the process level

The symbols which are displayed depend on

- type,
- operation as positioner or process controller,
- AUTOMATIC or MANUAL operating state and
- the activated functions.

Operation	Symbol	Description
Types 8792/8793	<u>AUTO</u>	AUTOMATIC operating state
Operation as positioner	☑	Diagnosis active (optional; only available if the device has the additional software for the diagnosis)
	<u>X.CO</u>	X.CONTROL / Positioner active (symbol is indicated for Type 8793 only)
	☑	Save EEPROM (is indicated during the save process)
	⚡	CUTOFF active
	≡	SAFEPOS active
	↔	Interface I/O Burst
	↕	Interface I/O RS232 HART
	🔒	SECURITY active
Other symbols for Type 8793 Operation as process controller	<u>P.CO</u>	P.CONTROL / Process controller active
	<u>BUS</u>	Bus active
	<u>SIM</u>	SIMULATION active

Table 23: Symbols of the process level.

MAN 1000118577 EN Version: K Status: RL (released | freigegeben) printed: 05.08.2022

## 17.2 Function of the keys

The functions of the 4 operating keys differ depending on the operating state (AUTOMATIC or MANUAL) and operating level (process level or setting level).

The key function which is active is displayed in the gray text field which is above the key.



The description of the operating levels and operating states can be found in Chapter "16 Operating levels" and "18 Operating states".

Key function on the process level:			
Key	Key function	Description of the function	Operating state
Arrow key △	OPN (OPEN)	Manual opening of the actuator.	MANUAL
		Change the displayed value (e.g. POS-CMD-TEMP-...).	AUTOMATIC
Arrow key ▽	CLS (CLOSE)	Manual closing of the actuator.	MANUAL
		Change the displayed value (e.g. POS-CMD-TEMP-...).	AUTOMATIC
Left selection key 	MENU	Change to the setting level. Note: Press key for approx. 3 s.	AUTOMATIC or MANUAL
Right selection key 	AUTO	Return to AUTOMATIC operating state.	MANUAL
	MANUAL	Change to MANUAL operating state.	AUTOMATIC

Key function on the setting level:			
Key	Key function	Description of the function	
Arrow key △		Scroll up in the menus.	
	+	Increase numerical values.	
Arrow key ▽		Scroll down in the menus.	
	-	Decrease numerical values.	
	<-	Change by one digit to the left; when entering numerical values.	
Left selection key 	EXIT (BACK)	Return to the process level. Gradually return from a submenu option.	
	ESC	Leave a menu.	
	STOP	Stop a sequence.	
Right selection key 	ENTER SELEC OK INPUT	Select, activate or deactivate a menu option.	
	EXIT (BACK)	Gradually return from a submenu option.	
	RUN	Start a sequence.	
	STOP	Stop a sequence.	

## 17.2.1 Entering and changing numerical values

Changing numerical values with fixed decimal places:


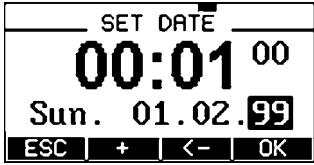






Key	Key function	Description of the function	Example
Arrow key ▽		Change to the next decimal place (from right to left). After reaching the last decimal place, the display switches back to the first decimal place.	Enter date and time.  
Arrow key △		Increase value. When the largest possible value has been reached, 0 is displayed again.	
Left selection key 	 or 	Return without change.	
Right selection key 		Accept the set value.	

Table 25: Change numerical values with fixed decimal places.

Enter numerical values with variable decimal places:


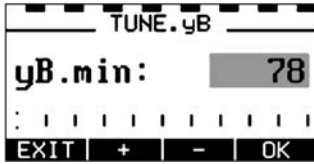






Key	Key function	Description of the function	Example
Arrow key △		Increase value.	Enter PWM signal  
Arrow key ▽		Reduce value.	
Left selection key 	 or 	Return without change.	
Right selection key 		Accept the set value.	

Table 26: Enter numerical values with variable decimal places.

## 17.3 Adjusting the display

The display can be individually adjusted for the operation and monitoring of the process.

- To do this, menu options can be activated for displaying the process level. *POS* and *CMD* are activated in the as-delivered state.
- The menu options which can be displayed depend on the type.



How you can adjust the display for Type 8792 individually to the process to be controlled is described in Chapter “26.2.18 EXTRAS – Setting the display”.

### 17.3.1 Possible displays of the process level

Possible displays in AUTOMATIC operating state	
	<p>Actual position of the valve actuator (0...100 %)</p>
	<ul style="list-style-type: none"> <li>• Set-point position of the valve actuator or</li> <li>• Set-point position of the valve actuator after rescaling by possibly activated split range function or correction characteristic (0...100 %)</li> </ul>
	<p>Internal temperature in the housing of the device (°C)</p>
	<p>Process actual value</p> <p>Only for type 8793</p>
	<p>Process set-point value</p> <p>Right selection key :</p> <p>The key function depends on the set-point value default (menu: <i>P.CONTROL</i> → <i>P.SETUP</i> → <i>SP-INPUT</i> → <i>internal/external</i>).</p> <p><b>INPUT</b> Set-point value default = <i>internal</i> <b>MANU</b> Set-point value default = <i>external</i></p> <p>Only for type 8793</p>
	<p>Graphical display of <i>SP</i> and <i>PV</i> with time axis</p> <p>Only for type 8793</p>



MAN 1000118577 EN Version: K Status: RL (released | freigegeben) printed: 05.08.2022

Possible displays in AUTOMATIC operating state	
	Graphical display of <i>POS</i> and <i>CMD</i> with time axis
	Time, weekday and date
	Input signal for set-point position (0...5/10 V or 0/4...20 mA) Only for operation as positioner <b>X.CO</b>
	Automatic adjustment of the positioner
	Automatic optimization of the process controller parameters Only for type 8793
	Automatic linearization of the process characteristics Only for type 8793
	Simultaneous display of the set-point position and the actual position of the valve actuator (0...100 %)
	Simultaneous display of the set-point position and the actual position of the valve actuator (0...100 %) Only for type 8793

Table 27: Displays of the process level in AUTOMATIC operating state

## 17.4 Date and time

Date and time are set on the process level in the *CLOCK* menu.

To ensure that the input menu for *CLOCK* can be selected on the process level, the following functions must be activated in 2 stages:

1. The *EXTRAS* auxiliary function in the *ADD.FUNCTION* menu
2. The *CLOCK* function in the *EXTRAS* auxiliary function, *DISP.ITEMS* submenu.

### Activating *EXTRAS* and *CLOCK*:











Key	Action	Description
<b>MENU</b>	Press  for approx. 3 s	Switching from process level ⇔ setting level.
▲ / ▼	Select <i>ADD.FUNCTION</i>	
<b>ENTER</b>	Press 	The possible auxiliary functions are displayed.
▲ / ▼	Select <i>EXTRAS</i>	
<b>ENTER</b>	Press 	Activate the <i>EXTRAS</i> auxiliary function by marking with a cross ☒ and transfer into the main menu (MAIN).
<b>EXIT</b>	Press 	Return to the main menu (MAIN).
▲ / ▼	Select <i>EXTRAS</i>	
<b>ENTER</b>	Press 	The submenus of <i>EXTRAS</i> are displayed.
▲ / ▼	Select <i>DISP.ITEMS</i>	
<b>ENTER</b>	Press 	The possible menu options are displayed.
▲ / ▼	Select <i>CLOCK</i>	
<b>SELEC</b>	Press 	The activated <i>CLOCK</i> function is now marked by a cross ☒.
<b>EXIT</b>	Press 	Return to the <i>EXTRAS</i> menu.
<b>EXIT</b>	Press 	Return to the main menu (MAIN).
<b>EXIT</b>	Press 	Switching from setting level ⇔ process level.

Table 28: *EXTRAS*; Activating the *CLOCK* function



Date and time must be reset whenever the device is restarted.  
After a restart the device therefore switches immediately and automatically to the corresponding input menu.

## 17.4.1 Setting date and time

→ On the process level select  $\triangle$   $\nabla$  the display for *CLOCK* using the arrow keys.

→ Press **INPUT** to open the input screen for the setting.

→ Set date and time as described in the following table.








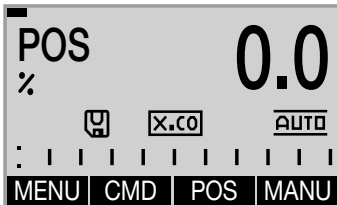
Key	Key function	Description of the function	Input screen
Arrow key $\nabla$		Switch to the next time unit (from right to left). When the last time unit for the date has been reached, the display switches to the time units for the time.  If the last unit is at top left (hours), the display switches back to the first unit at bottom right (year).	
Arrow key $\triangle$		Increase value. When the largest possible value has been reached, 0 is displayed again.	
Left selection key 		Return without change.	
Right selection key 		Accept the set value.	
$\triangle$ $\nabla$		Switching the display.	

Table 29: Setting date and time

## 18 OPERATING STATES

Type 8792/8793 has 2 operating states: AUTOMATIC and MANUAL.

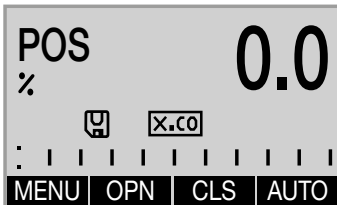
When the operating voltage is switched on, the device is in the AUTOMATIC operating state.



### AUTOMATIC

In the AUTOMATIC operating state normal controlled operation is implemented.

(The symbol for AUTOMATIC **AUTO** is shown on the display. (A bar runs along the upper edge of the display).



### MANUAL

In the MANUAL operating state the valve can be manually opened or closed via the arrow keys  $\Delta$   $\nabla$  (key function **OPN** and **CLS**).

(The symbol for AUTOMATIC **AUTO** is hidden. (No bar running along the upper edge of the display).



The MANUAL operating state (key function **MANU**) is for the following process value displays only:



*POS, CMD, PV, CMD/POS, SP/PV.*

For SP only for external process set-point value.

### 18.1 Changing the operating state

MANUAL or AUTOMATIC operating state is switched on the process level.

When switching to the setting level, the operating state is retained.

Change to MANUAL operating state	<b>MANU</b>	 press	Only available for process value display: <i>POS, CMD, PV, SP</i>
Return to AUTOMATIC operating state	<b>AUTO</b>	 press	

## 19 ACTIVATING AND DEACTIVATING AUXILIARY FUNCTIONS

Auxiliary functions can be activated for demanding control tasks.



The auxiliary function is activated via the *ADD.FUNCTION* basic function and transferred to the main menu (MAIN).  
The auxiliary functions can then be selected and set in the extended main menu (MAIN).

### 19.1 Activating auxiliary functions

Procedure:








Key	Action	Description
<b>MENU</b>	Press  for approx. 3 s	Switching from process level $\Rightarrow$ setting level.
<b>▲ / ▼</b>	Select <i>ADD.FUNCTION</i>	
<b>ENTER</b>	Press 	The possible auxiliary functions are displayed.
<b>▲ / ▼</b>	Select required auxiliary function	
<b>ENTER</b>	Press 	The selected auxiliary function is now marked by a cross <input checked="" type="checkbox"/> .
<b>EXIT</b>	Press 	Acknowledgment and simultaneous return to the main menu (MAIN). The marked function is now activated and incorporated into the main menu.
The parameters can then be set as follows.		
<b>▲ / ▼</b>	Select the auxiliary function	In the main menu (MAIN) select the auxiliary function.
<b>ENTER</b>	Press 	Opening the submenu to input the parameters. The setting of the submenu is described in the respective chapter of the auxiliary function.
Return from the submenu and switch to the process level		
<b>EXIT</b> *	Press 	Return to a higher level or to the main menu (MAIN).
<b>ESC</b> *		
<b>EXIT</b>	Press 	Switching from setting level $\Rightarrow$ process level.
* The designation of the key depends on the selected auxiliary function.		

Table 30: Activating auxiliary functions

**Principle: Activating auxiliary functions with simultaneous incorporation into the main menu**

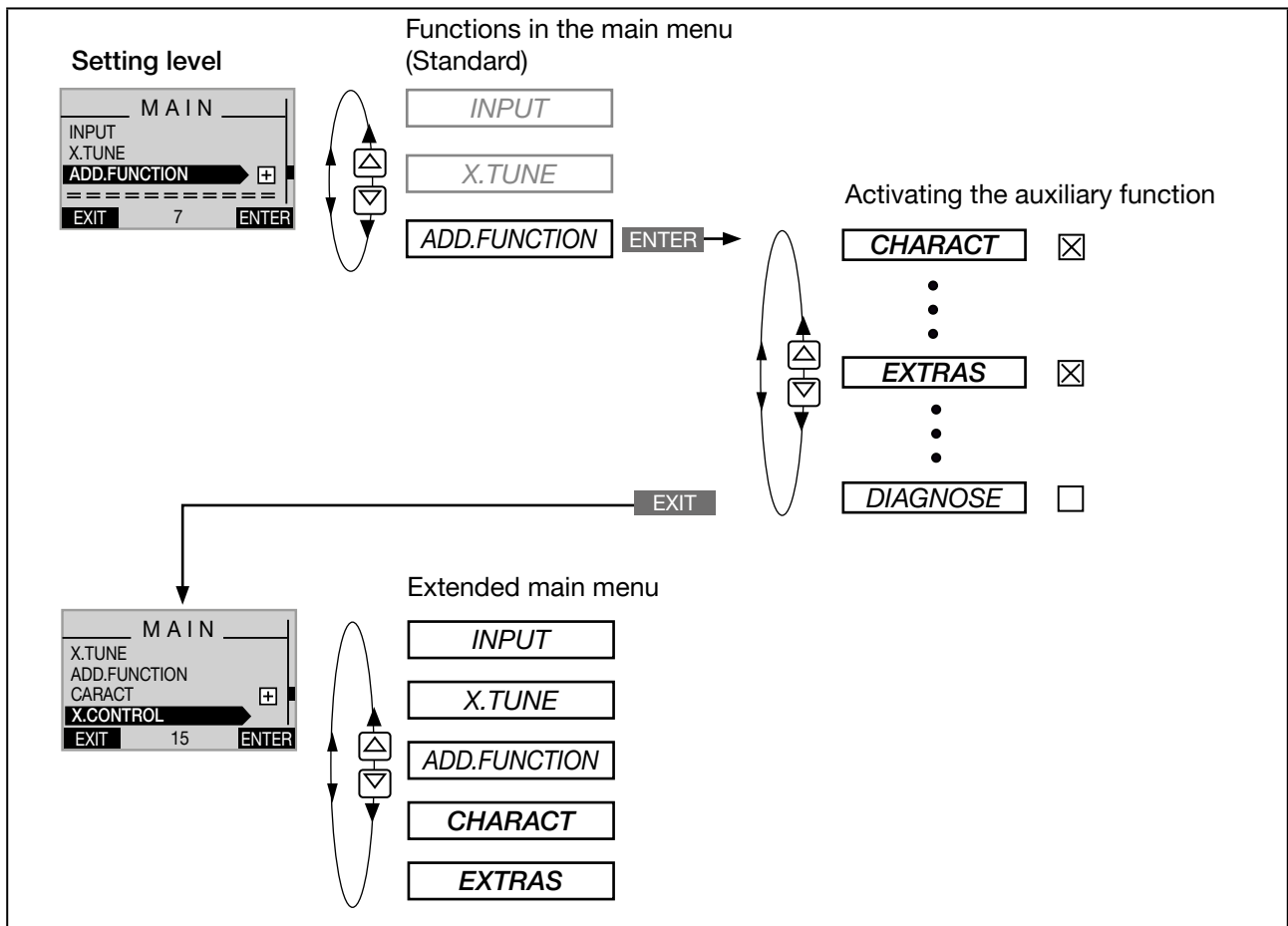


Fig. 30: Principle: Activating auxiliary functions with simultaneous incorporation into the main menu (MAIN)

## 19.2 Deactivating auxiliary functions

**Procedure:**










Key	Action	Description
<b>MENU</b>	Press  for approx. 3 s	Switching from process level ⇌ setting level.
 / 	Select <b>ADD.FUNCTION</b>	
<b>ENTER</b>	Press 	The possible auxiliary functions are displayed.
 / 	Select the auxiliary function	
<b>ENTER</b>	Press 	Remove function mark (no cross <input type="checkbox"/> ).
<b>EXIT</b>	Press 	Acknowledgment and simultaneous return to the main menu (MAIN). The marked function is now deactivated and removed from the main menu.

Table 31: Deactivating auxiliary functions

 Deactivation removes the auxiliary function from the main menu (MAIN). This will cause the previous settings, created under this function, to be rendered invalid.

## 20 MANUALLY OPENING AND CLOSING THE VALVE

In the MANUAL operating state, the valve can be opened and closed manually  $\triangle$   $\nabla$  using the arrow keys.



The MANUAL operating state (key function **MANU**) is for the following process value displays:

- *POS*, actual position of the valve actuator.
- *CMD*, set-point position of the valve actuator.  
When switching to MANUAL operating state, *POS* is displayed.
- *PV*, process actual value.
- *SP*, process set-point value.  
When switching to MANUAL operating state, *PV* is displayed. The switch is possible only for external set-point value default (menu: *P.CONTROL* → *P.SETUP* → *SP-INPUT* → *external*).
- *CMD/POS*, set-point position of the valve actuator.  
When switching to MANUAL operating state, *POS* is displayed.
- *SP/PV*, process set-point value.  
When switching to MANUAL operating state, *PV* is displayed. The switch is possible only for external set-point value default (menu: *P.CONTROL* → *P.SETUP* → *SP-INPUT* → *external*).

### Manually opening and closing valve:


Key	Action	Description
$\triangle$ / $\nabla$	Select <i>POS</i> , <i>CMD</i> , <i>PV</i> or <i>SP</i>	
<b>MANU</b>	Press 	Change to MANUAL operating state
$\triangle$	press	Aerate the actuator Control function A (SFA): Valve opens Control function B (SFB): Valve closes Control function I (SFI): Connection 2.1 aerated
$\nabla$	press	Bleed the actuator Control function A (SFA): Valve closes Control function B (SFB): Valve opens Control function I (SFI): Connection 2.2 aerated

Table 32: Manually opening and closing the valve



- SFA: Actuator spring force closing  
 SFB: Actuator spring force opening  
 SFI: Actuator double-acting

## 21 START-UP



Before start-up, carry out fluid and electrical installation of Type 8792/8793 and of the valve. For description see Chapter “13”, “14” and “15”.

When the operating voltage is applied, Type 8792/8793 is operating and is in the AUTOMATIC operating state. The display shows the process level with the values for *POS* and *CMD*.

The following basic settings must be made for starting up the device:

Device type	Sequence	Type of basic setting	Setting via	Description in chapter	Requirement
8792 and 8793	1	Basic setting of the device: Set input signal (standard signal).	<i>INPUT</i>	<a href="#">“23.1”</a>	essential
	2	Adjust device to the local conditions.	<i>X.TUNE</i>	<a href="#">“23.2”</a>	
only 8793 (Process controller)	3	Activate process controller.	<i>ADD.FUNCTION</i>	<a href="#">“24”</a>	essential
	4	Basic setting of the process controller: – Setting the hardware	<i>P.CONTROL</i>	<a href="#">“25”</a>	
			→ <i>SETUP</i>	<a href="#">“25.2”</a>	
	5	– Parameter setting of the software.	→ <i>PID.PARAMETER</i>	<a href="#">“25.3”</a>	
6	Automatic linearization of the process characteristics.	<i>P.Q’LIN</i>	<a href="#">“25.4”</a>	to be implemented optionally	
7	Automatic parameter setting for the process controller.	<i>P.TUNE</i>	<a href="#">“25.5”</a>		

Table 33: Start-up sequence

The basic settings are made on the setting level.

To switch from the process to the setting level, press the **MENU** key for approx. 3 seconds.

Then the main menu (MAIN) of the setting level is indicated on the display.



### WARNING!

**Risk of injury from improper operation.**

Improper operation may result in injuries as well as damage to the device and the area around it

- ▶ Before start-up, ensure that the operating personnel are familiar with and completely understand the contents of the operating instructions.
- ▶ Observe the safety instructions and intended use.
- ▶ Only adequately trained personnel may start up the equipment/the device.



## 22 BASIC SETTING OF THE DEVICE

The following settings must be made for the basic setting of Type 8792/8793:

1. **INPUT** Selection of the input signal (see Chapter “23.1”).
2. **X.TUNE** Automatic self-parameterization of the positioner (see Chapter “23.2”)

Operating structure for the basic setting:

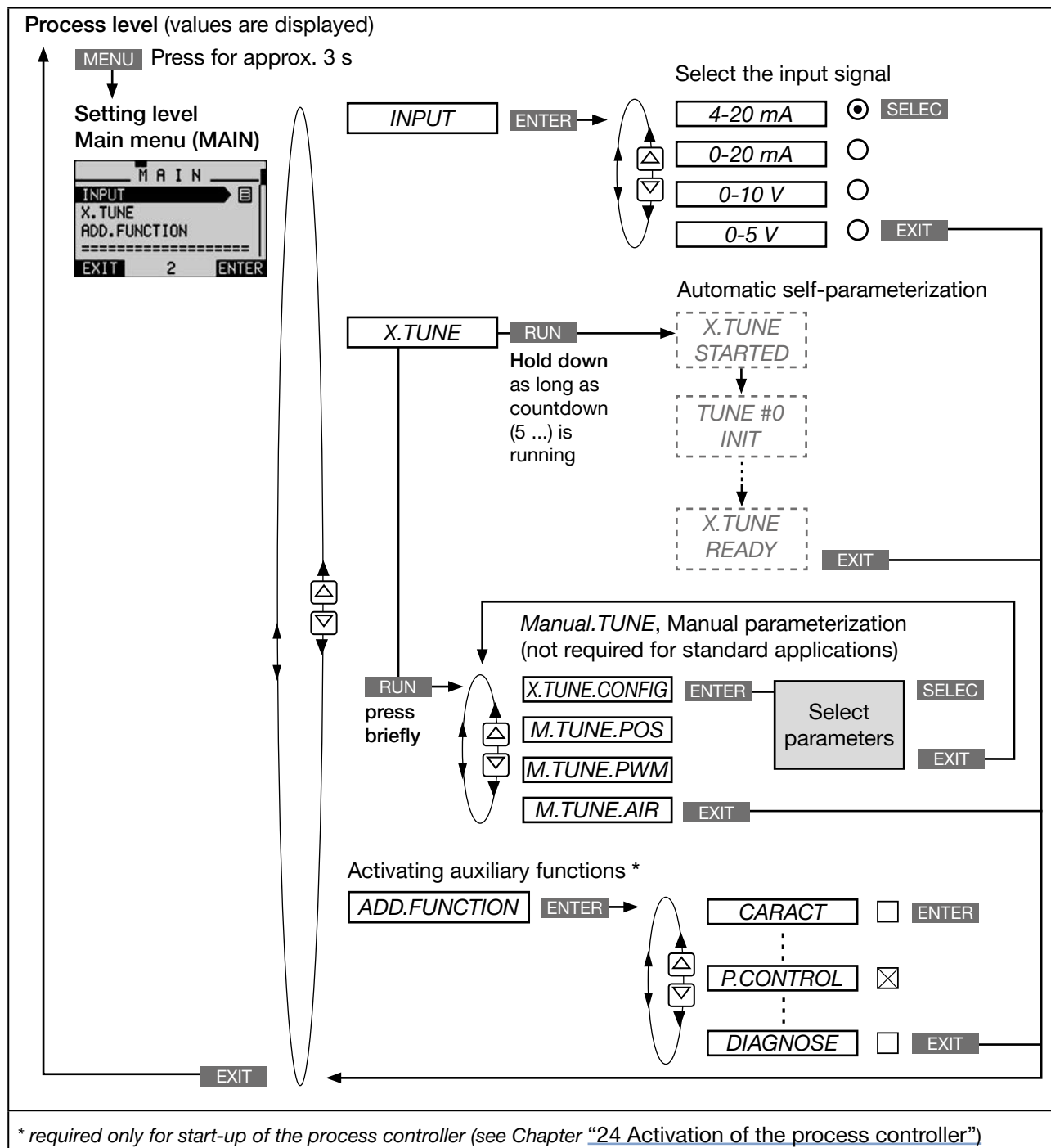


Fig. 31: MAIN – main menu, operating structure in as-delivered state

## 22.1 INPUT - Setting the input signal

This setting is used to select the input signal for the set-point value.

Procedure:







Key	Action	Description
<b>MENU</b>	Press  for approx. 3 s	Switching from process level $\Rightarrow$ setting level.
<b>▲ / ▼</b>	Select <i>INPUT</i>	
<b>ENTER</b>	Press 	The possible input signals for <i>INPUT</i> are displayed.
<b>▲ / ▼</b>	Select input signal (4-20 mA, 0-20 mA,...)	
<b>SELEC</b>	Press 	The selected input signal is now marked by a filled circle  .
<b>EXIT</b>	Press 	Return to the main menu (MAIN).
<b>EXIT</b>	Press 	Switching from setting level $\Rightarrow$ process level.

Table 34: Setting the input signal

Operating structure:

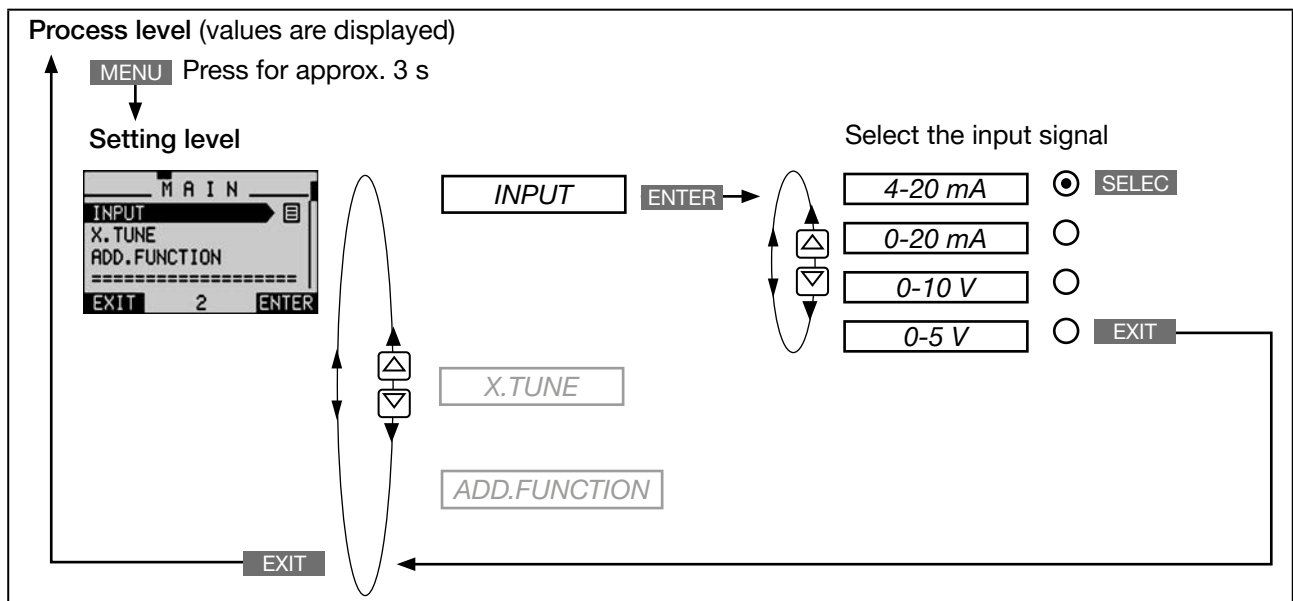


Fig. 32: Operating structure INPUT

## 22.2 X.TUNE – Automatic adjustment of the positioner

### WARNING!

Danger due to the valve position changing when the *X.TUNE* function is run.

When the *X.TUNE* function is run under operating pressure, there is an acute risk of injury.

- ▶ Never run *X.TUNE* while the process is running.
- ▶ Secure system against unintentional activation.

### NOTE!

An incorrect supply pressure or incorrectly connected operating medium pressure may cause the controller to be wrongly adjusted.

- ▶ Run *X.TUNE* in each case at the supply pressure available in subsequent operation (= pneumatic auxiliary power).
- ▶ Run the *X.TUNE* function preferably **without** operating medium pressure to exclude interference due to flow forces.

The following functions are actuated automatically:

- Adjustment of the sensor signal to the (physical) stroke of the actuator used.
- Determination of parameters of the PWM signals to control the solenoid valves integrated in type 8792/8793.
- Adjustment of the controller parameters for the positioner. Optimization occurs according to the criteria of the shortest possible transient time without overshoots.

### Procedure:









Key	Action	Description
	Press  for approx. 3 s	Switching from process level $\Rightarrow$ setting level.
	Select <i>X.TUNE</i>	
	 Hold down as long as countdown (5 ...) is running	While the automatic adjustment is running, messages on the progress of the <i>X.TUNE</i> (e.g. " <i>TUNE</i> #1...") are indicated on the display.  <i>When the automatic adjustment ends, the message "X.TUNE READY" is indicated.</i>
	Press any key	Return to the main menu (MAIN).
	Press 	Switching from setting level $\Rightarrow$ process level.

Table 35: Automatic adjustment of *X.TUNE*



To stop *X.TUNE*, press the left or right selection key .

Operating structure:

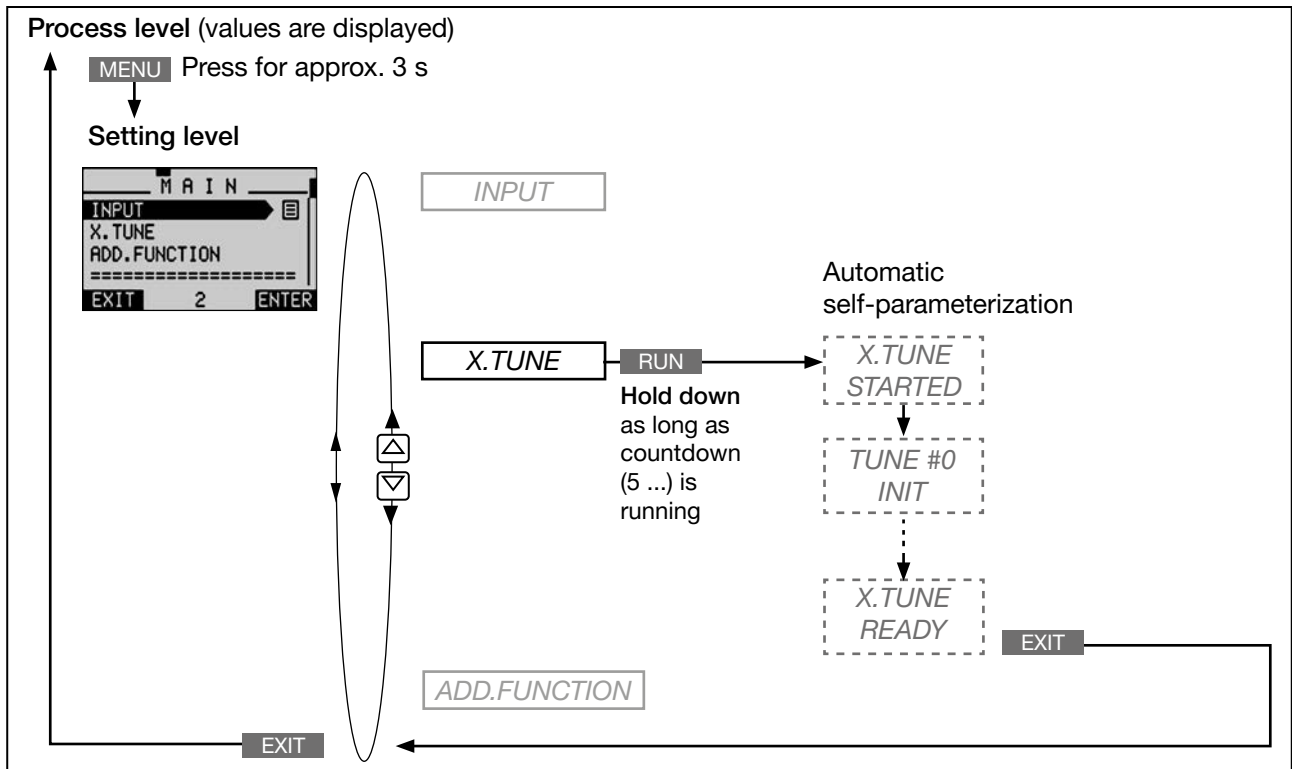



Fig. 33: Operating structure X.TUNE

**Automatically determining dead band DBND by running X.TUNE:**

**!** When X.TUNE is running, the dead band can be automatically determined depending on the friction behavior of the actuating drive. Before running X.TUNE, the X.CONTROL auxiliary function must be activated by incorporating it into the main menu (MAIN). If X.CONTROL is not activated, a fixed dead band of 1 % is used.

**!** The changed data is saved in the memory (EEPROM) only when there is a switch to the process level, by leaving the main menu (MAIN) using the left selection key **EXIT**. During the save process, the save symbol is indicated  on the display.

**Possible error messages when running X.TUNE:**

Display	Causes of error	Remedial action
TUNE err/break	Manual termination of self-parameterization by pressing the <b>EXIT</b> key	
X.TUNE locked	The X.TUNE function is blocked	Input access code
X.TUNE ERROR 1	No compressed air connected	Connect compressed air
X.TUNE ERROR 2	Compressed air failed during Autotune (X.TUNE).	Check compressed air supply
X.TUNE ERROR 3	Actuator or control system deaeration side leaking	Not possible, device defective

<i>X.TUNE</i> <i>ERROR 4</i>	Control system aeration side leaking	Not possible, device defective
<i>X.TUNE</i> <i>ERROR 5</i>	The rotational range of the position sensor is exceeded by 150°	Correct attachment of the position sensor shaft on the actuator (see chapter " <a href="#">12.2</a> " and " <a href="#">12.3</a> ").
<i>X.TUNE</i> <i>ERROR 6</i>	The end positions for <i>POS-MIN</i> and <i>POS-MAX</i> are too close together	Check compressed air supply
<i>X.TUNE</i> <i>ERROR 7</i>	Incorrect assignment <i>POS-MIN</i> and <i>POS-MAX</i>	To determine <i>POS-MIN</i> and <i>POS-MAX</i> , move the actuator in the direction indicated on the display.
<i>X.TUNE</i> <i>WARNING 1*</i>	Potentiometer is not coupled optimally to the actuator.  An optimum connection can provide a more accurate position measurement	Set middle position as described in chapter " <a href="#">12.2.4 Aligning lever mechanism</a> ".
* Warning information gives tips on optimized operation. The device is operational even if this warning information is not observed. Warning information is automatically hidden after several seconds.		

Table 36: *X.TUNE*; possible error messages

After making the settings described in Chapters "[23.1](#)" and "[23.2](#)", the positioner (positioner) is ready for use.

Activation and configuration of auxiliary functions is described in the following Chapter "[26 Configuring the auxiliary functions](#)".

### 22.2.1 *X.TUNE.CONFIG* – Manual configuration of *X.TUNE*

This function is needed for special requirements only.



For standard applications the *X.TUNE* function (automatic adjustment of the positioner), as described above, is run using the factory default settings.

The description of the *X.TUNE.CONFIG* function can be found in Chapter "[26.3 Manual configuration of \*X.TUNE\*](#)".

## 23 ACTIVATION OF THE PROCESS CONTROLLER

The process controller is activated by selecting the *P.CONTROL* auxiliary function in the *ADD.FUNCTION* menu.

The activation transfers *P.CONTROL* into the main menu (MAIN) where it is available for further settings.

Procedure:





Key	Action	Description
<b>MENU</b>	Press  for approx. 3 s	Switching from process level ⇔ setting level.
▲ / ▼	Select <i>ADD.FUNCTION</i>	
<b>ENTER</b>	Press 	The possible auxiliary functions are displayed.
▲ / ▼	Select <i>P.CONTROL</i>	
<b>ENTER</b>	Press 	<i>P.CONTROL</i> is now marked by a cross ☒.
<b>EXIT</b>	Press 	Acknowledgment and simultaneous return to the main menu (MAIN). <i>P.CONTROL</i> is now activated and incorporated into the main menu.

Table 37: Activating auxiliary functions



Following activation of *P.CONTROL*, the *P.Q'LIN* and *P.TUNE* menus are also available in the main menu (MAIN). They offer support for the setting of the process control.

*P.Q'LIN* Linearization of the process characteristic  
Description see Chapter [“25.4”](#)

*P.TUNE* Self-optimization of the process controller (process tune)  
Description see Chapter [“25.5”](#)

### **ADD.FUNCTION** – Add auxiliary functions

Apart from activating the process controller, *ADD.FUNCTION* can be used to activate auxiliary functions and incorporate them into the main menu.

The description can be found in Chapter [“26 Configuring the auxiliary functions”](#).

## 24 BASIC SETTING OF THE PROCESS CONTROLLER

### 24.1 P.CONTROL – Setting up and parameterization of the process controller

To start up the process controller, you must make the following settings in the *P.CONTROL* menu:

1. SETUP Set up the process controller (configuration)
2. PID.PARAMETER Parameterize process controller

Operating structure:

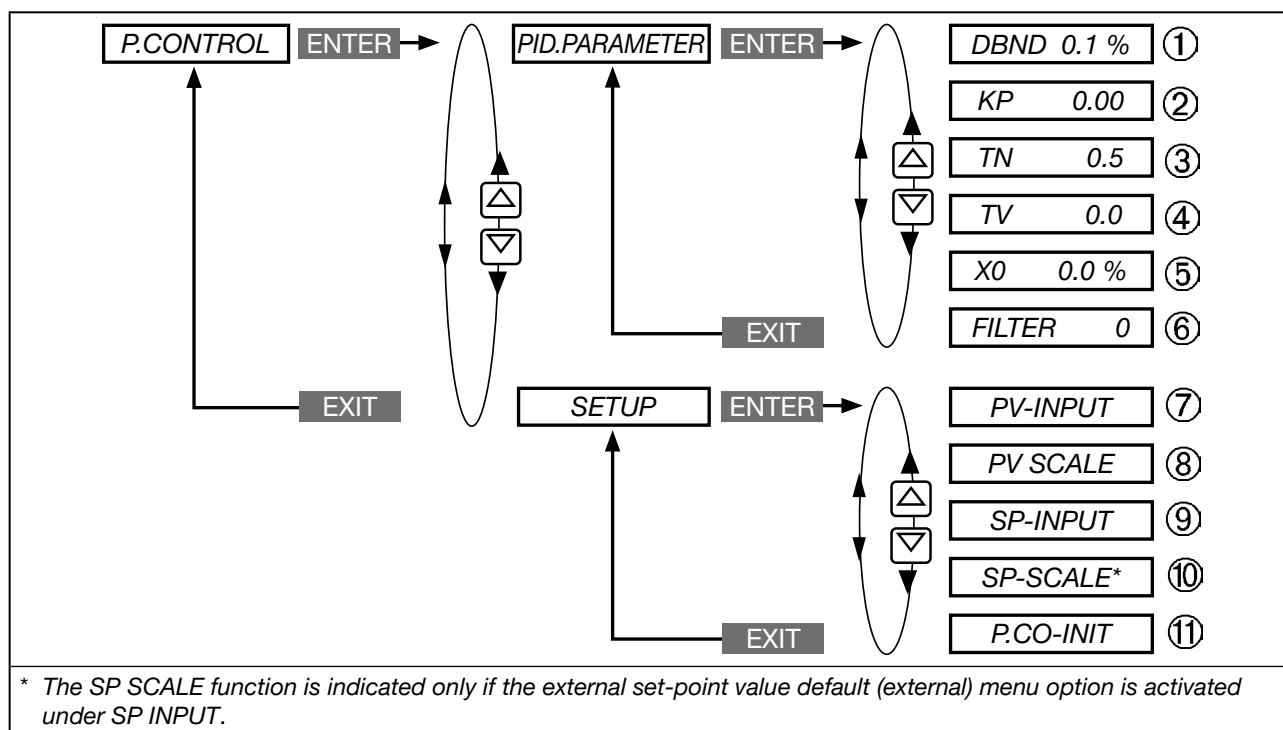


Fig. 34: Operating structure P.CONTROL

#### Key:

- ① Insensitivity range (dead band) of the PID process controller
- ② Amplification factor of the process controller
- ③ Reset time
- ④ Hold-back time
- ⑤ Operating point
- ⑥ Filtering of the process actual value input
- ⑦ Indication of the signal type for process actual value (4 - 20 mA, frequency input, Pt 100 input)
- ⑧ Specification of the physical unit and scaling of the process actual value
- ⑨ Type of set-point value default (intern or extern)
- ⑩ Scaling of the process set-point value (only for external set-point value default)
- ⑪ Enables a smooth switchover between AUTOMATIC and MANUAL mode

**Procedure:**









Key	Action	Description
<b>MENU</b>	Press  for approx. 3 s	Switching from process level $\Rightarrow$ setting level.
<b>▲ / ▼</b>	Select <i>P.CONTROL</i>	Selection in the main menu (MAIN).
<b>ENTER</b>	Press 	The submenu options for basic settings can now be selected.
<b>1. Set up process controller (configuration)</b>		
<b>▲ / ▼</b>	Select <i>SETUP</i>	
<b>ENTER</b>	Press 	The menu for setting up the process controller is displayed. Set up is described in Chapter <a href="#">“25.2 SETUP – Setting up the process controller”</a> .
<b>EXIT</b>	Press 	Return to <i>P.CONTROL</i> .
<b>2. Parameterize process controller</b>		
<b>▲ / ▼</b>	Select <i>PID.PARAMETER</i>	
<b>ENTER</b>	Press 	The menu for parameterizing the process controller is displayed. Parameterization is described in Chapter <a href="#">“25.3 PID.PARAMETER – Parameterizing the process controller”</a> .
<b>EXIT</b>	Press 	Return to <i>P.CONTROL</i> .
<b>EXIT</b>	Press 	Return to the main menu (MAIN).
<b>EXIT</b>	Press 	Switching from setting level $\Rightarrow$ process level.

Table 38: *P.CONTROL*; basic settings of the process controller



## 24.2 SETUP – Setting up the process controller

These functions specify the type of control.

The procedure is described in the following Chapters “25.2.1” to “25.2.5”.

### 24.2.1 PV-INPUT – Specifying signal type for the process actual value

One of the following signal types can be selected for the process actual value:

- Standard signal                      4...20 mA                      flow rate, pressure, level
- Frequency signal                      0...1000 Hz                      flow rate
- Circuit with Pt 100                      -20 °C...+220 °C                      temperature

Factory setting: 4...20 mA

When the operating voltage has been switched on, the device looks for connected sensor types (automatic sensor detection).

When a sensor type (PT 100 or 4...20 mA) is detected, the signal type is automatically implemented in the PV-INPUT operating menu.

If no sensor signal is detected, the last setting is retained.

The signal type frequency signal cannot be detected automatically, but must be set manually in the PV-INPUT menu.

Operating structure:

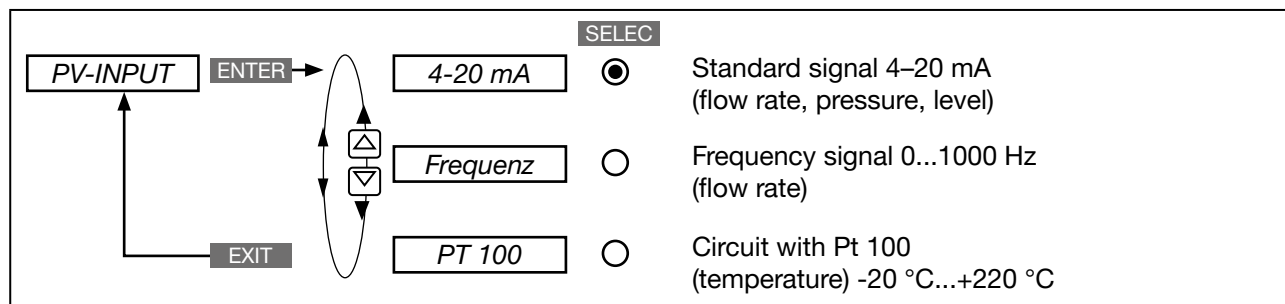


Fig. 35: Operating structure PV-INPUT

#### Specifying signal type in the menu SETUP → PV-INPUT:

Key	Action	Description
▲ / ▼	Select PV-INPUT	
ENTER	Press	The signal types are displayed.
▲ / ▼	Select signal type	
SELEC	Press	The selected signal type is now marked by a filled circle ●.
EXIT	Press	Return to SETUP.

Table 39: PV-INPUT; Specifying signal type

### 24.2.2 PV-SCALE – Scaling of the process actual value

The following settings are specified in the submenu of PV-SCALE:

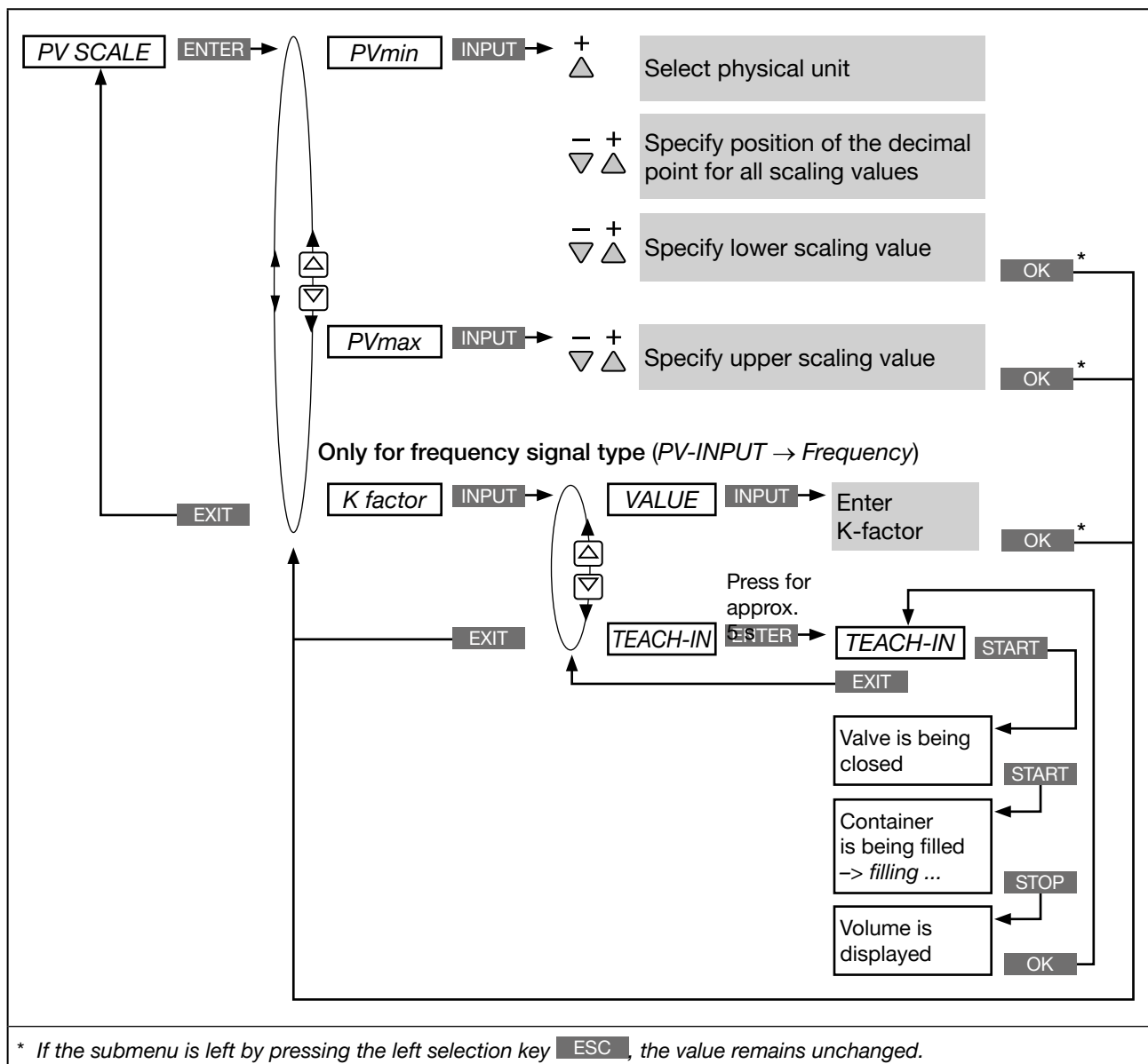
- PVmin**
  1. The physical unit of the process actual value.
  2. Position of the decimal point of the process actual value.
  3. Lower scaling value of the process actual value.

**!** In *PVmin* the unit of the process actual value and the position of the decimal point are specified for all scaling values (*SPmin*, *SPmax*, *PVmin*, *PVmax*).

**PVmax** Upper scaling value of the process actual value.

**K factor** K-factor for the flow sensor  
The menu option is available only for the frequency signal type (*PV-INPUT* → *Frequency*).

Operating structure:



MAN 1000118577 EN Version: K Status: RL (released | freigegeben) printed: 05.08.2022

Fig. 36: Operating structure PV-SCALE

### 24.2.2.1. Effects and dependencies of the settings of PV-INPUT on PV-SCALE

The settings in the PV-SCALE menu have different effects, depending on the signal type selected in PV-INPUT.



Even the selection options for the units of the process actual value (in PVmin) depend on the signal type selected in PV-INPUT.

See following "Table 40"

Settings in the submenu of PV-SCALE	Description of the effect	Dependency on the signal type selected in PV-INPUT		
		4 - 20 mA	PT 100	Frequency
<b>PVmin</b>	Selectable unit of the process actual value for the physical variables.	Flow rate, temperature, pressure, length, volume. (as well as ratio as % and no unit)	Temperature	Flow-rate
	Adjustment range:	0...9999 (Temperature -200...800)	-200...800	0...9999
<b>PVmin</b> <b>PVmax</b>	Specification of the reference range for the dead band of the process controller (P.CONTROL → PID.PARAMETER → DBND).	Yes	Yes	Yes
	Specification of the reference range for the analog feedback (option). See Chapter "26.2.14 OUTPUT – Configuring the outputs (option)".	Yes	Yes	Yes
	Sensor calibration:	Yes see "Fig. 37"	No	No
<b>K factor</b>	Sensor calibration:	No	No	Yes see "Fig. 38"
	Adjustment range:	–	–	0...9999

Table 40: Effects of the settings in PV-SCALE depending on the signal type selected in PV-INPUT

Example of a sensor calibration for signal type 4 - 20 mA:

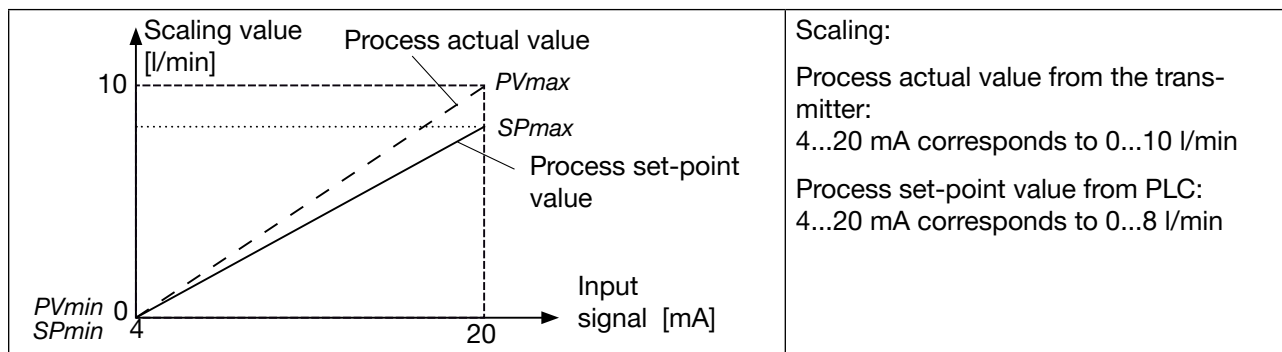


Fig. 37: Example of a sensor calibration for signal type 4 - 20 mA

**!** For internal set-point value default (*SP-INPUT* → *intern*), the process set-point value is input directly on the process level.

Example of a sensor calibration for *frequency* signal type:

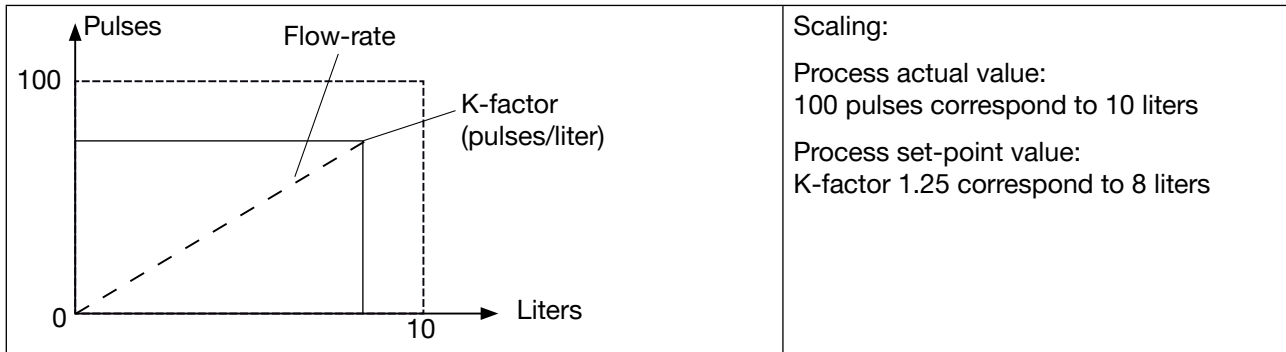


Fig. 38: Example of a sensor calibration for frequency signal type

Scaling of the process actual value in the menu *SETUP* → *PV-SCALE*:

Key	Action	Description
▲ / ▼	Select <i>PV-SCALE</i>	Selection in the main menu (MAIN).
ENTER	Press	The submenu options for scaling of the process actual value are displayed.
<b>1. Setting <i>PVmin</i></b>		
▲ / ▼	Select <i>PVmin</i>	
INPUT	Press	The input screen is opened. First specify the physical unit which has a dark background.
▲	Press <b>+</b> (x times)	Select physical unit.
▼	<b>&lt;-</b> Select decimal point	The decimal point has a dark background.
▲	Press <b>+</b> (x times)	Specify position of the decimal point.
▼	<b>&lt;-</b> Select scaling value	The last digit of the scaling value has a dark background.
▲ / ▼	<b>+</b> Increase value <b>&lt;-</b> Select decimal place	Set scaling value (lower process actual value).
OK	Press	Return to <i>PV-SCALE</i> .
<b>2. Setting <i>PVmax</i></b>		
▲ / ▼	Select <i>PVmax</i>	
INPUT	Press	The input screen is opened. The last digit of the scaling value has a dark background.
▲ / ▼	<b>+</b> Increase value <b>&lt;-</b> Select decimal place	Set scaling value (upper process actual value).
OK	Press	Return to <i>PV-SCALE</i> .



















Key	Action	Description
<b>3. Setting K-factor (only available for frequency signal type)</b>		
▲ / ▼	Select <i>K-factor</i>	
ENTER	Press 	The submenu for the setting of the K-factor is displayed.
<b>either</b>		
▲ / ▼	Select <i>VALUE</i>	<b>Manual input of the K-factor.</b>
INPUT	Press 	The input screen is opened. The decimal point has a dark background.
▲	 Select decimal point	Specify position of the decimal point.
▼	 Select value	The last digit of the value has a dark background.
▲ / ▼	 Select decimal place  Increase value	Set K-factor.
OK	Press 	Return to <i>K-factor</i> .
<b>or</b>		
▲ / ▼	Select <i>TEACH-IN</i>	<b>Calculating the K-factor by measuring a specific flow rate.</b>
ENTER	Press  for approx. 5 s	The valve is being closed.
START	Press 	The container is being filled.
STOP	Press 	The measured volume is displayed and the input screen is opened. The decimal point has a dark background.
▲	 Select decimal point	Specify position of the decimal point.
▼	 Select value	The last digit of the value has a dark background.
▲ / ▼	 Select decimal place  Increase value	Set the measured volume.
OK	Press 	Return to <i>TEACH-IN</i> .
EXIT	Press 	Return to <i>K-factor</i> .
EXIT	Press 	Return to <i>PV-SCALE</i> .
EXIT	Press 	Return to <i>SETUP</i> .

Table 41: PV-SCALE; scaling process actual value



If the submenu is left by pressing the left selection key **ESC**, the value remains unchanged.

### 24.2.3 SP-INPUT – Type of the set-point value default (intern or extern)

The SP-INPUT menu specifies how the default of the process set-point value is to be implemented.

- Intern: Input of the set-point value on the process level
- Extern: Default of the set-point value via the standard signal input

Operating structure:

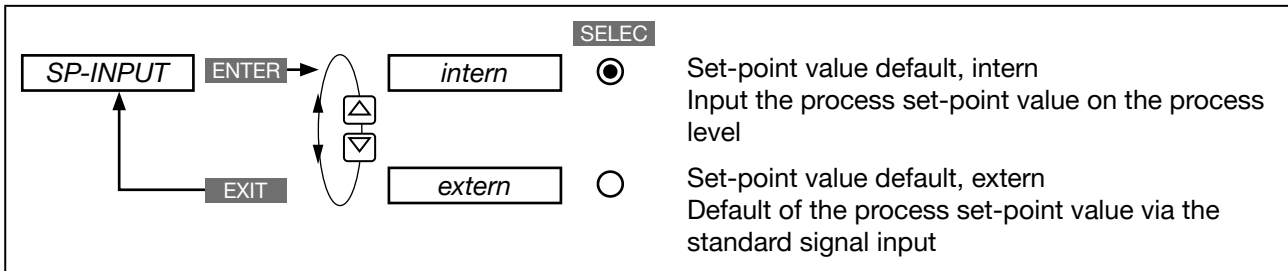


Fig. 39: Operating structure PV-INPUT

Specify type of set-point value default in the menu *SETUP* → *SP-INPUT*:

Key	Action	Description
▲ / ▼	Select <i>SP-INPUT</i>	
ENTER	Press	The types of set-point value default are displayed.
▲ / ▼	Select the type of set-point value default	
SELEC	Press	The selection is marked by a filled circle ●.
EXIT	Press	Return to <i>SETUP</i> .

Table 42: *SP-INPUT*; specifying type of the set-point value default



For internal set-point value default (*SP-INPUT* → *intern*), the process set-point value is input directly on the process level.

### 24.2.4 SP-SCALE – Scaling of the process set-point value (for external set-point value default only)

The *SP-SCALE* menu assigns the values for the lower and upper process set-point value to the particular current or voltage value of the standard signal.

The menu is available for external set-point value default only (*SP-INPUT* → *extern*).



For internal set-point value default (*SP-INPUT* → *internal*), there is no scaling of the process set-point value via *SPmin* and *SPmax*.

The set-point value is input directly on the process level. The physical unit and the position of the decimal point are specified during the scaling of the process actual value (*PV-SCALE* → *PVmin*). For description see Chapter “25.2.2 *PV-SCALE* – Scaling of the process actual value”, page 84

Operating structure:

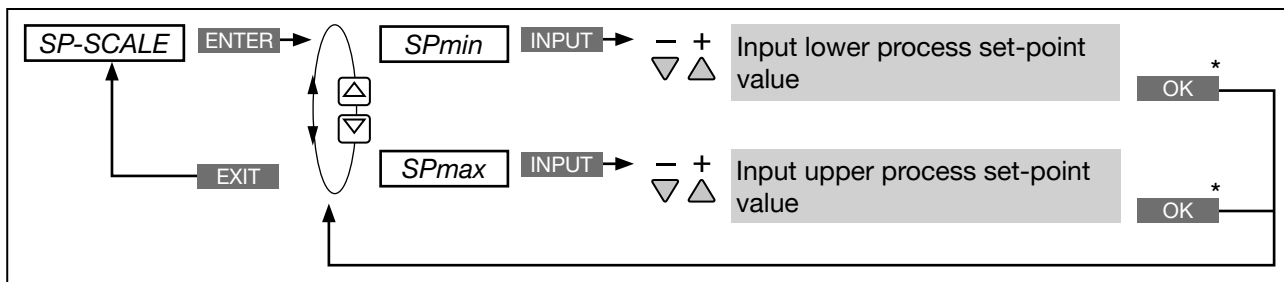


Fig. 40: Operating structure SP-SCALE

Scaling process set-point value **SETUP** → **SP-SCALE**:

Key	Action	Description
▲ / ▼	Select <b>SP-SCALE</b>	
ENTER	Press	The submenu options for scaling of the process set-point value are displayed.
▲ / ▼	Select <b>SPmin</b>	
INPUT	Press	The input screen is opened.
▲ / ▼	+ Increase value <- Select decimal place	Set scaling value (lower process set-point value). The value is assigned to the smallest current or voltage value of the standard signal.
OK	Press	Return to <b>SP-SCALE</b> .
▲ / ▼	Select <b>SPmax</b>	
INPUT	Press	The input screen is opened.
▲ / ▼	+ Increase value <- Select decimal place	Set scaling value (upper process set-point value). The value is assigned to the largest current or voltage value of the standard signal.
OK	Press	Return to <b>SP-SCALE</b> .
EXIT	Press	Return to <b>SETUP</b> .

Table 43: **SP-SCALE**; scaling process set-point value

If the submenu is left by pressing the left selection key **ESC**, the value remains unchanged.

MAN 1000118577 EN Version: K Status: RL (released | freigegeben) printed: 05.08.2022

### 24.2.5 P.CO-INIT – Smooth switchover MANUAL-AUTOMATIC

The smooth switchover between the MANUAL and AUTOMATIC states can be activated or deactivated in the *P.CO-INIT* menu.

Factory default setting: *bumpless* Smooth switchover activated.

Operating structure:

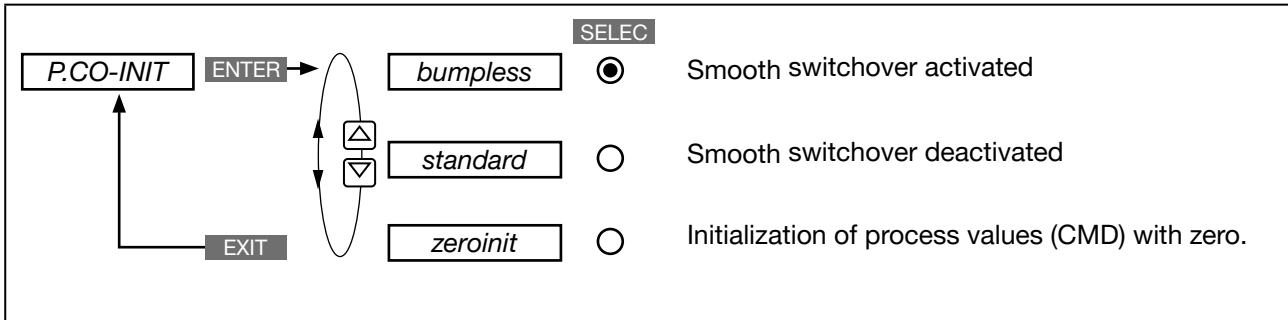


Fig. 41: Operating structure *P.CO-INIT*

Procedure:

Key	Action	Description
▲ / ▼	Select <i>P.CO-INIT</i>	
<b>ENTER</b>	Press	The selection ( <i>bumpless</i> ) and ( <i>standard</i> ) is displayed.
▲ / ▼	Select required function	<i>bumpless</i> = smooth switchover activated <i>standard</i> = smooth switchover deactivated
<b>SELEC</b>	Press	The selection is marked by a filled circle ●.
<b>EXIT</b>	Press	Return to <i>SETUP</i> .

Table 44: *P.CO-INIT*; smooth switchover MANUAL-AUTOMATIC



## 24.3 PID.PARAMETER – Parameterizing the process controller

The following control parameters of the process controller are manually set in this menu.

<b>DBND</b> 1.0 %	Insensitivity range (dead band) of the process controller
<b>KP</b> 1.00	Amplification factor of the (P-contribution of the PID controller)
<b>TN</b> 999.0	Reset time (I-contribution of the PID controller)
<b>TV</b> 0.0	Hold-back time (D-contribution of the PID controller)
<b>X0</b> 0.0 %	Operating point
<b>FILTER</b> 0	Filtering of the process actual value input



The automatic parameterization of the PID controller integrated in the process controller (menu options *KP*, *TN*, *TV*) can be implemented with the aid of the *P.TUNE* function (see Chapter “25.5 P.TUNE – Self-optimization of the process controller”).









Basic information for setting the process controller can be found in Chapters “37 Properties of PID Controllers” and “38 Adjustment rules for PID Controllers”.

### 24.3.1 Procedure for inputting the parameters

The settings in the *PID.PARAMETER* menu are always made in the same way.

Procedure:

Key	Action	Description
▲ / ▼	Select <i>PID.PARAMETER</i>	
ENTER	Press 	The menu for parameterizing the process controller is displayed.
▲ / ▼	Select menu option	
INPUT	Press 	The input screen is opened.
▲ / ▼	+ Increase value – Reduce value or <- Select decimal place + Increase value	Set value when * <b>DBND</b> X.X % / <b>X0</b> 0 % / <b>FILTER</b> 5 : Set value when * <b>KP</b> X.XX / <b>TN</b> X.0 sec / <b>TV</b> 1.0 sec :
OK	Press 	Return to <i>PID.PARAMETER</i> .
EXIT	Press 	Return to <i>P.CONTROL</i> .
EXIT	Press 	Return to the main menu (MAIN).
EXIT	Press 	Switching from setting level ⇌ process level.

\* The description of the submenus of *PID.PARAMETER* can be found in the following chapters.

Table 45: *PID.PARAMETER*; parameterizing process controller



If the submenu is left by pressing the left selection key **ESC**, the value remains unchanged.

### 24.3.2 DBND – Insensitivity range (dead band)

This function causes the process controller to respond from a specific control difference only. This protects both the solenoid valves in Type 8792/8793 and the pneumatic actuator.

Factory setting: 1.0 % with reference to the range of the scaled process actual value (setting in the menu *PV-SCALE* → *PVmin* → *PVmax*).

Operating structure:

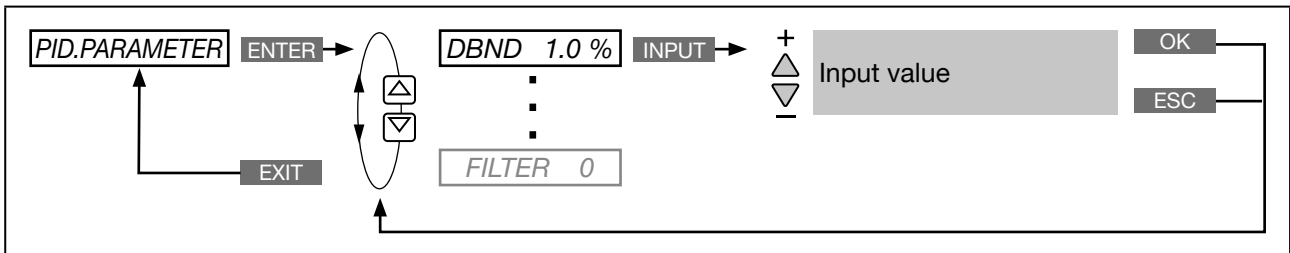


Fig. 42: Operating structure DBND; insensitivity range

Insensitivity range for process control

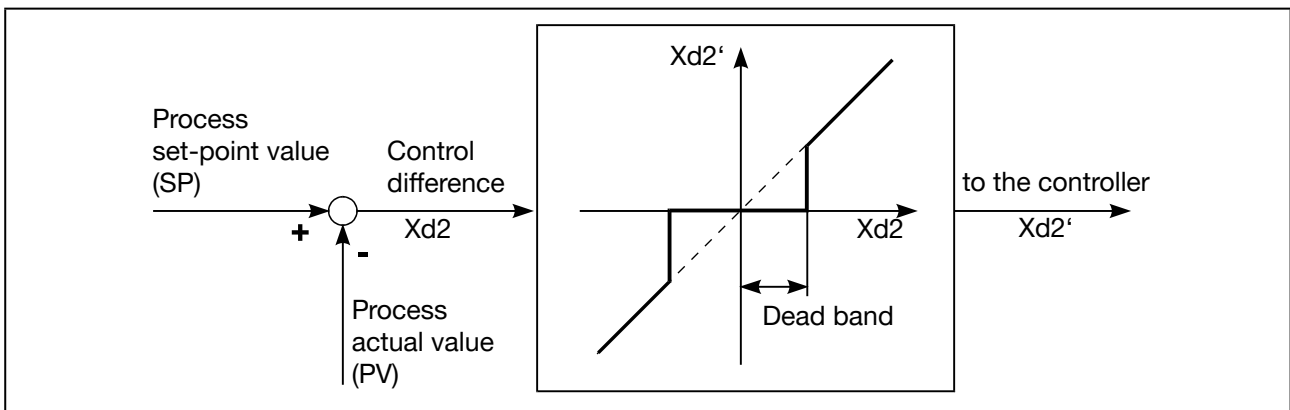


Fig. 43: Diagram DBND; insensitivity range for process control

### 24.3.3 KP – Amplification factor of the process controller

The amplification factor specifies the P-contribution of the PID controller (can be set with the aid of the *P.TUNE* function).

Factory setting: 1.00

Operating structure:

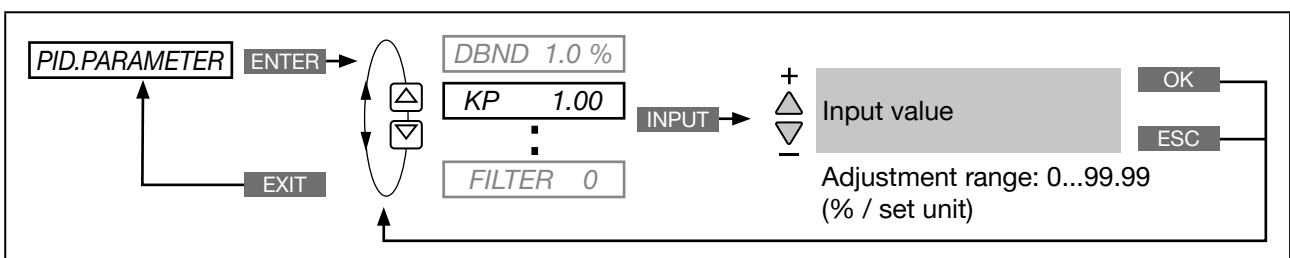


Fig. 44: Operating structure KP; amplification factor

**!** The *KP* amplification of the process controller refers to the scaled, physical unit.

### 24.3.4 TN – Reset time of the process controller

The reset time specifies the I-contribution of the PID controller (can be set with the aid of the *P.TUNE* function).

Factory setting: 999.9 s

Operating structure:

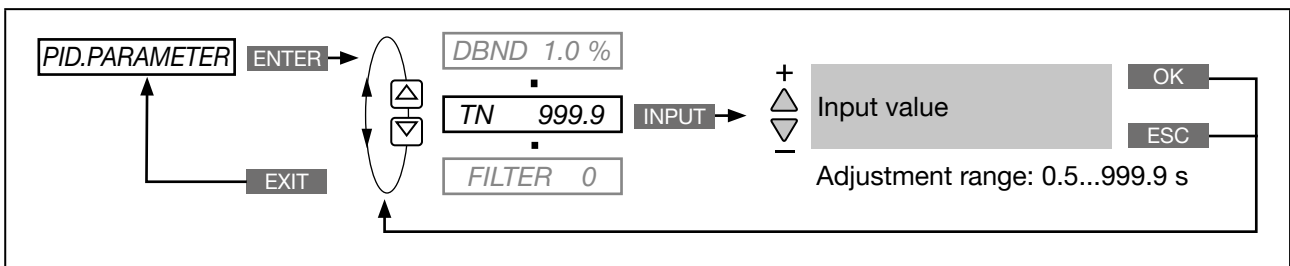


Fig. 45: Operating structure TN; reset time

### 24.3.5 TV – Hold-back time of the process controller

The hold-back time specifies the D-contribution of the PID controller (can be set with the aid of the *P.TUNE* function).

Factory setting: 0.0 s

Operating structure:



Fig. 46: Operating structure TV; hold-back time

### 24.3.6 X0 – Operating point of the process controller

The operating point corresponds to the size of the proportional portion when control difference = 0.

Factory setting: 0.0 %

Operating structure:

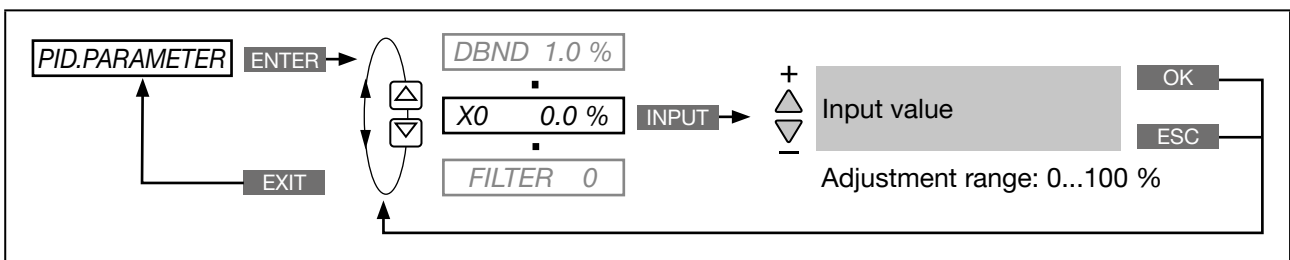


Fig. 47: Operating structure X0; operating point

### 24.3.7 FILTER – Filtering of the process actual value input

The filter is valid for all process actual value types and has a low pass behavior (PT1).

Factory setting: 0

Operating structure:

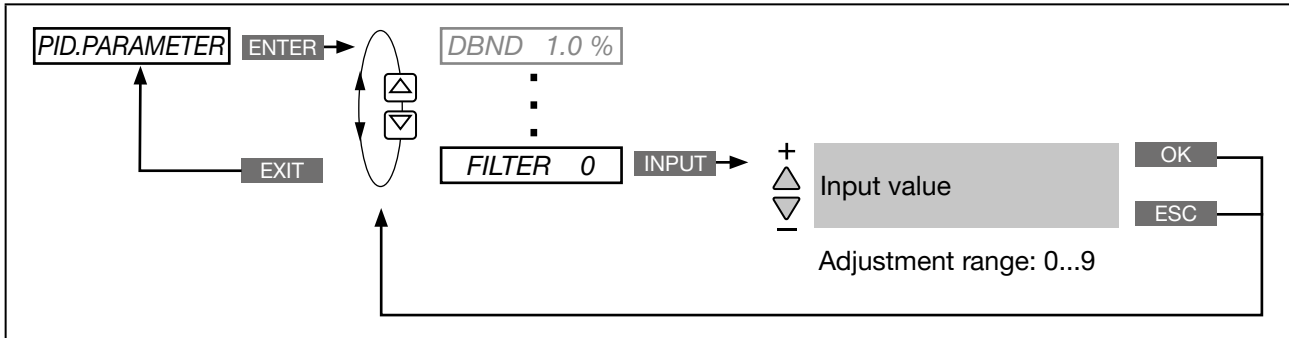


Fig. 48: Operating structure FILTER; filtering of the process actual value input

#### Setting the filter effect in 10 stages

Setting	Corresponds to cut-off frequency (Hz)	Effect
0	10	Lowest filter effect
1	5	
2	2	
3	1	
4	0.5	
5	0.2	
6	0.1	
7	0.07	
8	0.05	
9	0.03	Largest filter effect

Table 46: Setting the filter effect



On page 216 you will find a table for entering your set parameters.

## 24.4 P.Q'LIN – Linearization of the process characteristic

This function automatically linearizes the process characteristic.

In doing so, the nodes for the correction characteristic are automatically determined. To do this, the program moves through the valve stroke in 20 steps and measures the associated process variable.

The correction characteristic and the associated value pairs are saved in the menu option *CHARACT* → *FREE*. This is where they can be viewed and freely programmed. For a description see Chapter “26.2.1”.

If the *CARACT* menu option has still not been activated and incorporated into the main menu (MAIN), this will happen automatically when *P.Q'LIN* is being run.

### Run P.Q'LIN:



Key	Action	Description
▲ / ▼	Select <i>P.Q'LIN</i>	The function is in the main menu (MAIN) after activation of <i>P.CONTROL</i> .
<b>RUN</b>	 Hold down as long as countdown (5 ...) is running	<i>P.Q'LIN</i> is started.
	The following displays are indicated on the display:	
	<i>Q'LIN</i> #0 <i>CMD</i> =0%  <i>Q.LIN</i> #1 <i>CMD</i> =10%  ... continuing to  <i>Q.LIN</i> #10 <i>CMD</i> =100%	Display of the node which is currently running (progress is indicated by a progress bar along the upper edge of the display).
	<i>Q.LIN</i> ready	Automatic linearization was successfully completed.
<b>EXIT</b>	Press 	Return to the main menu (MAIN).

Table 47: *P.Q'LIN*; Automatic linearization of the process characteristic

### Possible error messages when running *P.Q'LIN*:

Display	Cause of fault	Remedial action
<i>Q.LIN</i> err/break	Manual termination of linearization by pressing the <b>EXIT</b> key.	
<i>P.Q'LIN</i> <i>ERROR 1</i>	No supply pressure connected.	Connect supply pressure.
	No change to process variable.	Check process and, if required, switch on pump or open the shut-off valve. Check process sensor.
<i>P.Q'LIN</i> <i>ERROR 2</i>	Failure of the supply pressure while <i>P.Q'LIN</i> running.	Check supply pressure.
	Automatic adjustment of the <i>X.TUNE</i> positioner not run.	Run <i>X.TUNE</i> .

Table 48: *P.Q'LIN*; possible error messages

## 24.5 *P.TUNE* – Self-optimization of the process controller

This function can be used to automatically parameterize the PID controller integrated in the process controller.

In doing so, the parameters for the P, I and D-contribution of the PID controller are automatically determined and transferred to the corresponding menus of (*KP*, *TN*, *TV*). This is where they can be viewed and changed.

### Explanation of the PID controller:

The control system of Type 8793 has an integrated PID process controller. Any process variable, such as flow rate, temperature, pressure, etc., can be controlled by connecting an appropriate sensor.

To obtain good control behavior, the structure and parameterization of the PID controller must be adjusted to the properties of the process (controlled section).

This task requires control experience as well as measuring instruments and is time-consuming. The *P.TUNE* function can be used to automatically parameterize the PID controller integrated in the process controller.



Basic information for setting the process controller can be found in Chapters “[37 Properties of PID Controllers](#)” and “[38 Adjustment rules for PID Controllers](#)”.

### 24.5.1 The mode of operation of *P.TUNE*

The *P.TUNE* function automatically identifies the process. To do this, the process is activated with a defined disturbance variable. Typical process characteristics are derived from the response signal and the structure and parameters of the process controller are determined on the basis of the process characteristics.

When using *P.TUNE* self-optimization, optimum results are obtained under the following conditions:

- Stable or stationary conditions concerning the process actual value *PV* when starting *P.TUNE*.
- Execution of *P.TUNE* in the operating point or within the operating range of the process control.

### 24.5.2 Preparatory measure for execution of *P.TUNE*



The measures described below are not compulsory conditions for execution of the function *P.TUNE*. However, they will increase the quality of the result.

The *P.TUNE* function can be run in the MANUAL or AUTOMATIC operating state.

When *P.TUNE* is complete, the control system is in the operating state which was set previously.

### 24.5.2.1. Preparatory measures for execution of *P.TUNE* in the MANUAL operating state

Moving process actual value *PV* to the operating point:



Key	Action	Description
<b>Setting on the process level:</b>		
▲ / ▼	Select <i>PV</i>	The process actual value <i>PV</i> is indicated on the display.
MANU	Press 	Change to MANUAL operating state. The input screen for manually opening and closing the valve is displayed.
▲	Open valve <b>OPN</b> or	By opening or closing the control valve, move the process actual value to the required operating point.
▼	Close valve <b>CLS</b>	
As soon as the process actual value <i>PV</i> is constant, the <i>P.TUNE</i> function can be started.		

Table 49: *P.TUNE*; preparatory measure for running *X.TUNE* in the MANUAL operating state

### 24.5.2.2. Preparatory measure for execution of *P.TUNE* in the AUTOMATIC operating state

By inputting a process set-point value *SP*, move the process actual value *PV* to the operating point.

 Observe the internal or external set-point value default for the input (*P,CONTROL* → *SETUP* → *SP-INPUT* → *intern/extern*):

For intern set-point value default: Input the process set-point value *SP* via the device keyboard (see description below "[Table 50](#)").

For extern set-point value default: Input the process set-point value *SP* via the analog set-point value input.

Inputting a process set-point value:





Key	Action	Description
<b>Setting on the process level:</b>		
▲ / ▼	Select <i>SP</i>	The process set-point value is indicated on the display.
INPUT	Press 	The input screen for inputting the process set-point value is displayed.
▲ / ▼	Input value  Select decimal place  Increase value	The selected set-point value <i>SP</i> should be near the future operating point.
OK	Press 	Acknowledge input and return to the display of <i>SP</i> .

Table 50: *P.TUNE*; preparatory measure for running *X.TUNE* in the AUTOMATIC operating state

The process variable *PV* is changed according to the set-point value default based on the factory default PID parameters.

→ Before running the *P.TUNE* function, wait until the process actual value *PV* has reached a stable state.



To observe *PV*, it is recommended to select via the arrow keys ▲ / ▼ the graphical display *SP/PV(t)*.  
To be able to select the display *SP/PV(t)*, it must be activated in the EXTRAS menu (see Chapter “26.2.18 EXTRAS – Setting the display”).

→ If *PV* oscillates continuously, the preset amplification factor of the process controller *KP* in the menu *P.CONTROL* → *PID.PARAMETER* should be reduced.

→ As soon as the process actual value *PV* is constant, the *P.TUNE* function can be started.

### 24.5.3 Starting the function *P.TUNE*



#### **WARNING!**

**Risk of injury from uncontrolled process.**

While the *P.TUNE* function is running, the control valve automatically changes the current degree of opening and intervenes in the running process.

- ▶ Using suitable measures, prevent the permitted process limits from being exceeded.  
For example by:
  - an automatic emergency shutdown
  - stopping the *P.TUNE* function by pressing the STOP key (press left or right key).

#### Procedure:

Key	Action	Description
<b>MENU</b>	Press  for approx. 3 s	Switching from process level ⇒ setting level
▲ / ▼	Select <i>P.TUNE</i>	
<b>RUN</b>	Hold down as long as countdown (5 ...) is running	During the automatic adjustment the following messages are indicated on the display. " <i>starting process tune</i> " - Start self-optimization. " <i>identifying control process</i> " - Process identification. Typical process variables are determined from the response signal to a defined stimulus. " <i>calculating PID parameters</i> " - Structure and parameters of the process controller are determined. " <i>TUNE ready</i> " - Self-optimization was successfully completed.
	Press any key	Return to the main menu (MAIN).
<b>EXIT</b>	Press	Switching from setting level ⇒ process level.

Table 51: Automatic adjustment of *X.TUNE*



To stop *P.TUNE*, press the left or right selection key **STOP**.



The changed data is saved in the memory (EEPROM) only when there is a switch to the process level, by leaving the main menu (MAIN) using the left selection key **EXIT**. During the save process, the save symbol is indicated on the display.



Possible error messages when running *P.TUNE*:

Display	Cause of fault	Remedial action
<i>TUNE</i> <i>err/break</i>	Manual termination of self-optimization by pressing the <b>EXIT</b> key.	
<i>P.TUNE</i> <i>ERROR 1</i>	No supply pressure connected.	Connect supply pressure.
	No change to process variable.	Check process and, if required, switch on pump or open the shut-off valve.  Check process sensor.

Table 52: *P.TUNE*; possible error messages

After making all the settings described in Chapter [“21 Start-up”](#), the process controller is ready for use.

Activation and configuration of auxiliary functions is described in the following Chapter [“26 Configuring the auxiliary functions”](#).

## 25 CONFIGURING THE AUXILIARY FUNCTIONS

The device has auxiliary functions for demanding control tasks.

This chapter describes how the auxiliary functions are activated, set and configured.





### 25.1 Activating and deactivating auxiliary functions

The required auxiliary functions must be activated by the user initially by incorporation into the main menu (MAIN). The parameters for the auxiliary functions can then be set.




To deactivate a function, remove it from the main menu. This will cause the previous settings, created under this function, to be rendered invalid again.

#### 25.1.1 Including auxiliary functions in the main menu

Procedure:

Key	Action	Description
<b>MENU</b>	Press  for approx. 3 s	Switching from process level ⇔ setting level.
<b>▲ / ▼</b>	Select <i>ADD.FUNCTION</i>	
<b>ENTER</b>	Press 	The possible auxiliary functions are displayed.
<b>▲ / ▼</b>	Select required auxiliary function	
<b>ENTER</b>	Press 	The selected auxiliary function is now marked by a cross ☒.
<b>EXIT</b>	Press 	Acknowledgment and simultaneous return to the main menu (MAIN). The marked function is now activated and incorporated into the main menu.


The parameters can then be set as follows.

<b>▲ / ▼</b>	Select the auxiliary function	In the main menu (MAIN) select the auxiliary function.
<b>ENTER</b>	Press 	Opening the submenu to input the parameters. Further information about the setting can be found in the following chapter <a href="#">“26.2 Overview and description of the auxiliary functions”</a>
<b>EXIT</b> * <b>ESC</b> *	Press 	Return to a higher level or to the main level (MAIN).
<b>EXIT</b>	Press 	Switching from setting level ⇔ process level.

\* The designation of the key depends on the selected auxiliary function.

Table 53: Incorporating auxiliary functions



The changed data is saved in the memory (EEPROM) only when there is a switch to the process level, by leaving the main menu (MAIN) using the left selection key **EXIT**. During the save process, the save symbol is indicated  on the display.

### 25.1.2 Removing auxiliary functions from the main menu

**!** If a function is removed from the main menu, the settings implemented previously under this function become invalid again.

Procedure:

Key	Action	Description
<b>MENU</b>	Press  for approx. 3 s	Switching from process level $\Rightarrow$ setting level.
<b>▲ / ▼</b>	Select <b>ADD.FUNCTION</b>	
<b>ENTER</b>	Press	The possible auxiliary functions are displayed.
<b>▲ / ▼</b>	Select the auxiliary function	
<b>ENTER</b>	Press	Remove function mark (no cross <input type="checkbox"/> ).
<b>EXIT</b>	Press	Acknowledgment and simultaneous return to the main menu (MAIN). The marked function is now deactivated and removed from the main menu.

Table 54: Removing auxiliary functions

### 25.1.3 Principle of including auxiliary functions in the main menu

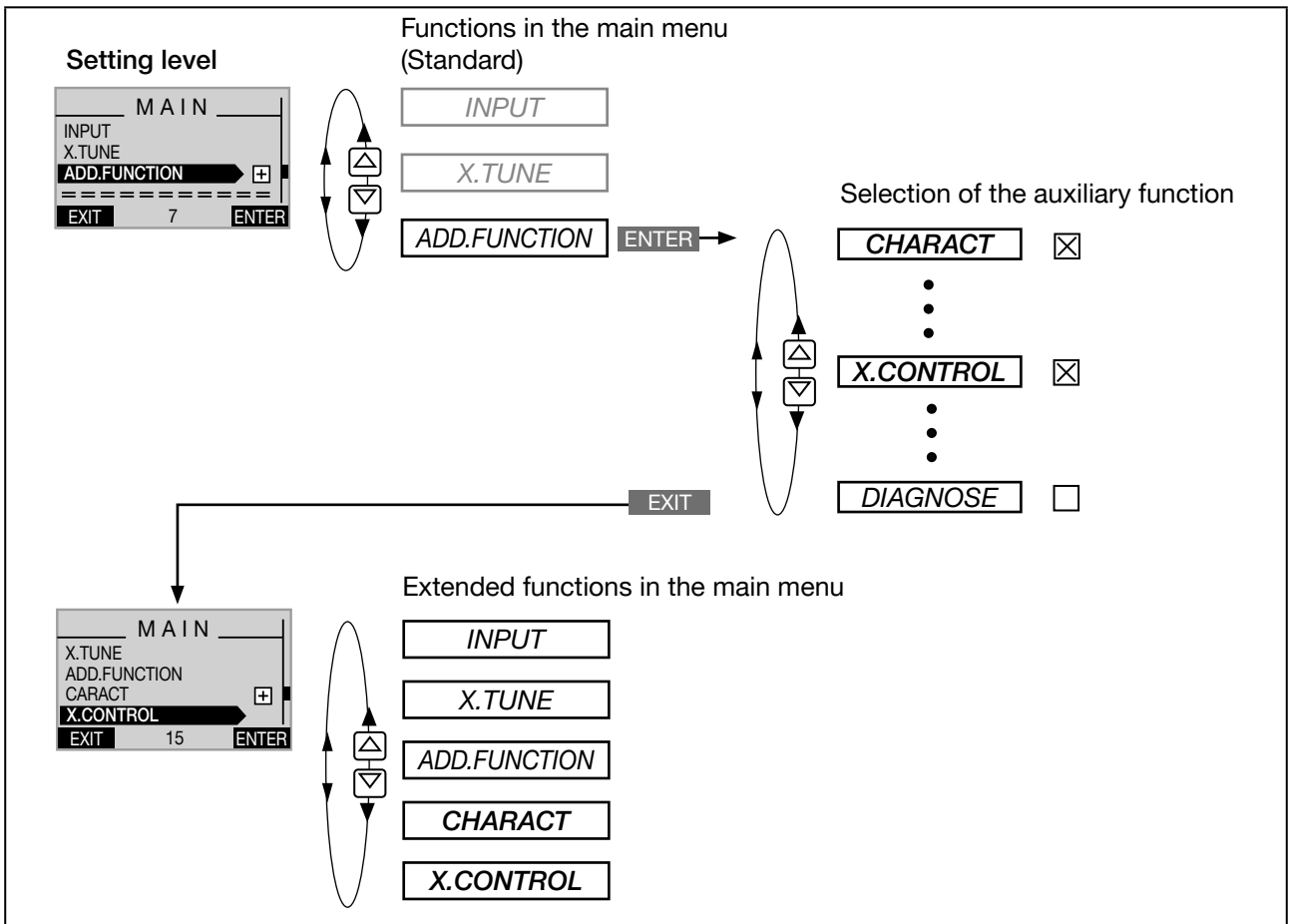


Fig. 49: Incorporating auxiliary functions into the main menu

MAN 1000118577 EN Version: K Status: RL (released | freigegeben) printed: 05.08.2022

## 25.2 Overview and description of the auxiliary functions

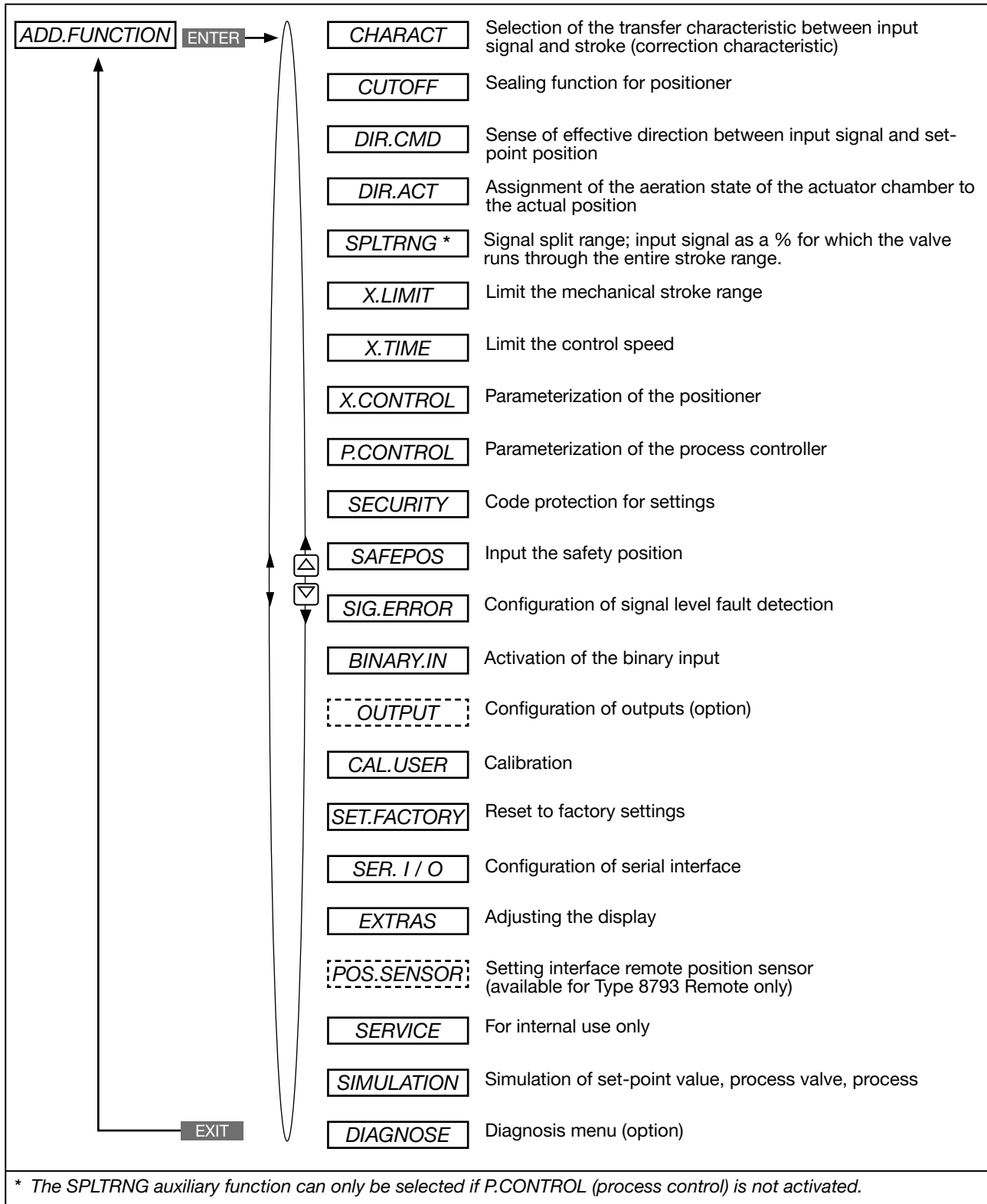


Fig. 50: Overview - auxiliary functions

## 25.2.1 CHARACT – Select the transfer characteristic between input signal (position set-point value) and stroke

Characteristic (customer-specific characteristic)

Use this auxiliary function to select a transfer characteristic with reference to set-point value (nominal position, *CMD*) and valve stroke (*POS*) for correction of the flow-rate or operating characteristic.

Factory setting: *linear*



Each auxiliary function, which is to be set, must be incorporated initially into the main menu (MAIN). See Chapter “26.1 Activating and deactivating auxiliary functions”, page 100.

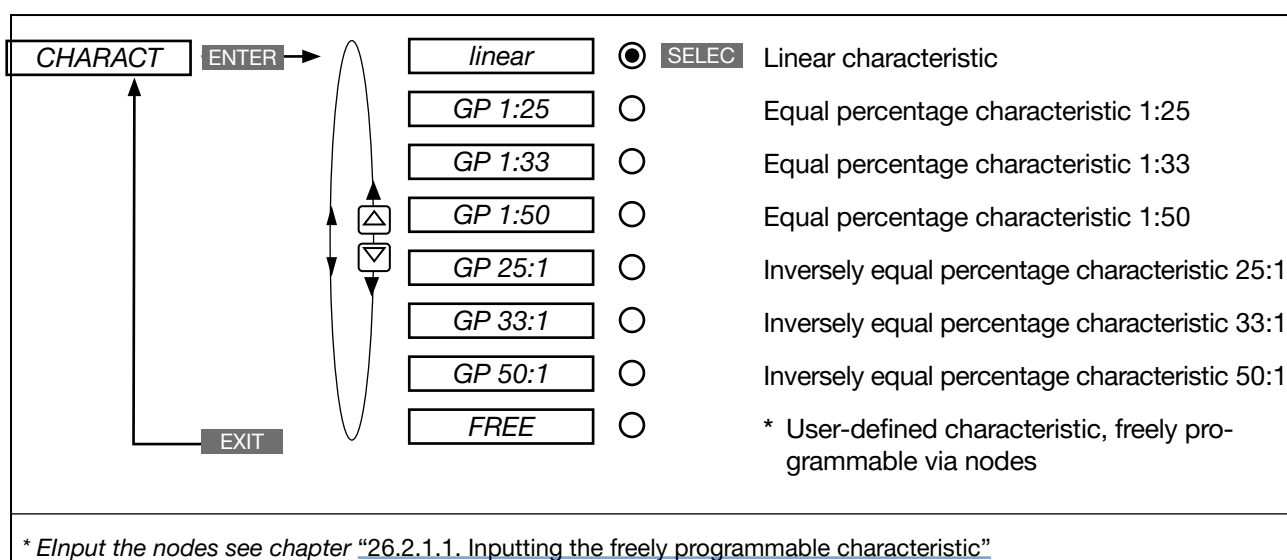


Fig. 51: Operating structure CHARACT

The flow characteristic  $k_v = f(s)$  indicates the flow-rate of a valve, expressed by the  $k_v$  value depending on the stroke  $s$  of the actuator spindle. It is specified by the design of the valve seat and the seat seal. In general two types of flow characteristics are implemented, the linear and the equal percentage.

In the case of linear characteristics identical  $k_v$  value changes  $k_v$  are assigned to identical stroke changes  $ds$ .

$$(dk_v = n_{lin} \cdot ds).$$

In the case of an equal percentage characteristic an equal percentage change of the  $k_v$  value corresponds to a stroke change  $ds$ .

$$(dk_v/k_v = n_{equalper} \cdot ds).$$

The operating characteristic  $Q = f(s)$  specifies the correlation between the volumetric flow  $Q$  in the installed valve and the stroke  $s$ . This characteristic has the properties of the pipelines, pumps and consumers. It therefore exhibits a form which differs from the flow characteristic.

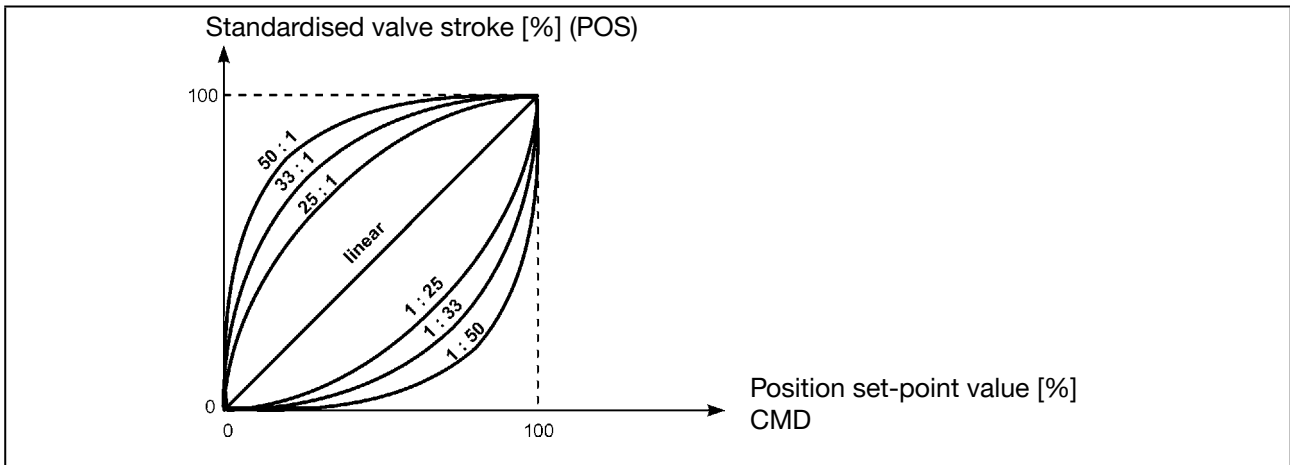


Fig. 52: Characteristics

In the case of control tasks for closed-loop control systems it is usually particular demands which are placed on the course of the operating characteristic, e.g. linearity. For this reason it is occasionally necessary to correct the course of the operating characteristic in a suitable way. For this purpose the Type 8792/8793 features a transfer element which implements different characteristics. These are used to correct the operating characteristic.

Equal percentage characteristics 1:25, 1:33, 1:50, 25:1, 33:1 and 50:1 and a linear characteristic can be set. Furthermore, a characteristic can be freely programmed via nodes or automatically calibrated.

### 25.2.1.1. Inputting the freely programmable characteristic

The characteristic is defined via 21 nodes which are distributed uniformly via the position set-point values ranging from 0 – 100 %. Their distance is 5 %. A freely selectable stroke (adjustment range 0 – 100 %) is assigned to each node. The difference between the stroke values of two adjacent nodes must not be larger than 20 %.

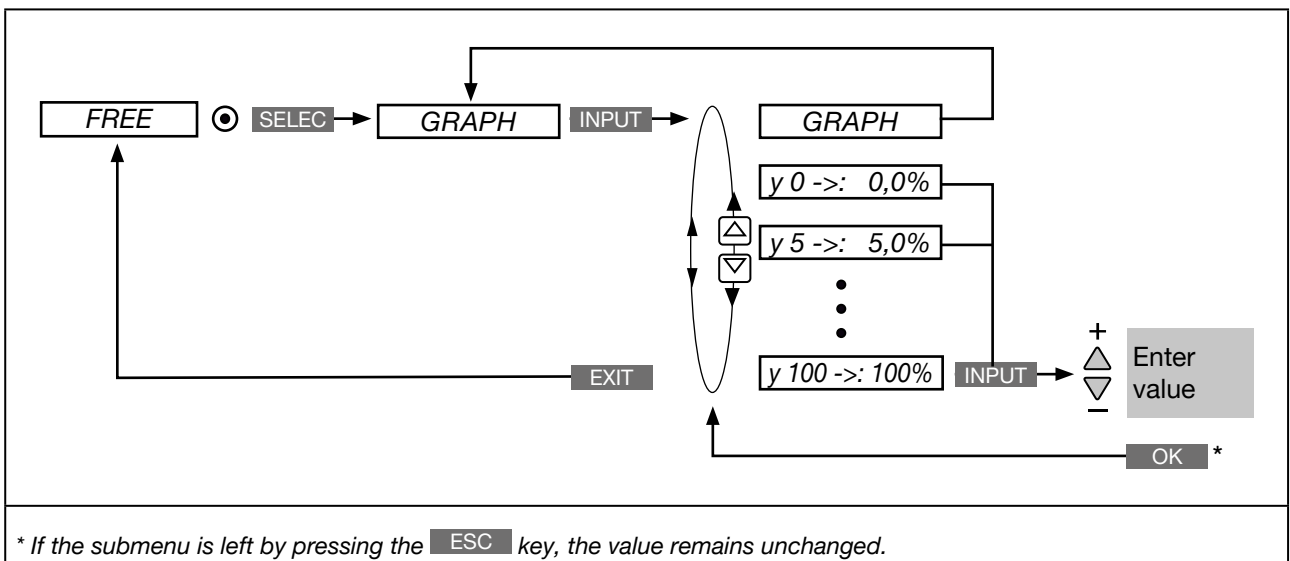


Fig. 53: Operating structure CHARACT FREE

Procedure:

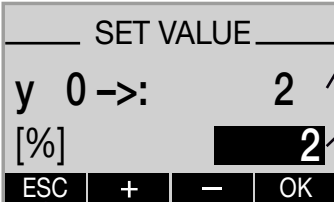
Key	Action	Description
<b>MENU</b>	Press  for approx. 3 s	Switching from process level ⇌ setting level.
	Select <i>CHARACT</i>	(To do this, the auxiliary function must be incorporated into the main menu).
<b>ENTER</b>		Menu options of <i>CHARACT</i> are displayed.
	Select <i>FREE</i>	
<b>SELEC</b>	Press	The graphical display of the characteristic is displayed.
<b>INPUT</b>	Press	Submenu with the individual nodes (as %) is opened.
	Select node	
<b>INPUT</b>	Press	The <i>SET-VALUE</i> input screen for inputting values is opened. 
	Input value: Increase value Reduce value	Input value for the selected node.
<b>OK</b>	Press	Acknowledge input and return to the <i>FREE</i> submenu.
<b>EXIT</b>	Press	Return to the <i>CHARACT</i> menu.
<b>EXIT</b>	Press	Return to the main menu (MAIN).
<b>EXIT</b>	Press	Switching from setting level ⇌ process level. The changed data is saved in the memory (EEPROM).

Table 55: *FREE*; Inputting the freely programmable characteristic

The changed data is saved in the memory (EEPROM) only when there is a switch to the process level, by leaving the main menu (MAIN) using the left selection key **EXIT**. During the save process, the save symbol on the display.

Example of a programmed characteristic

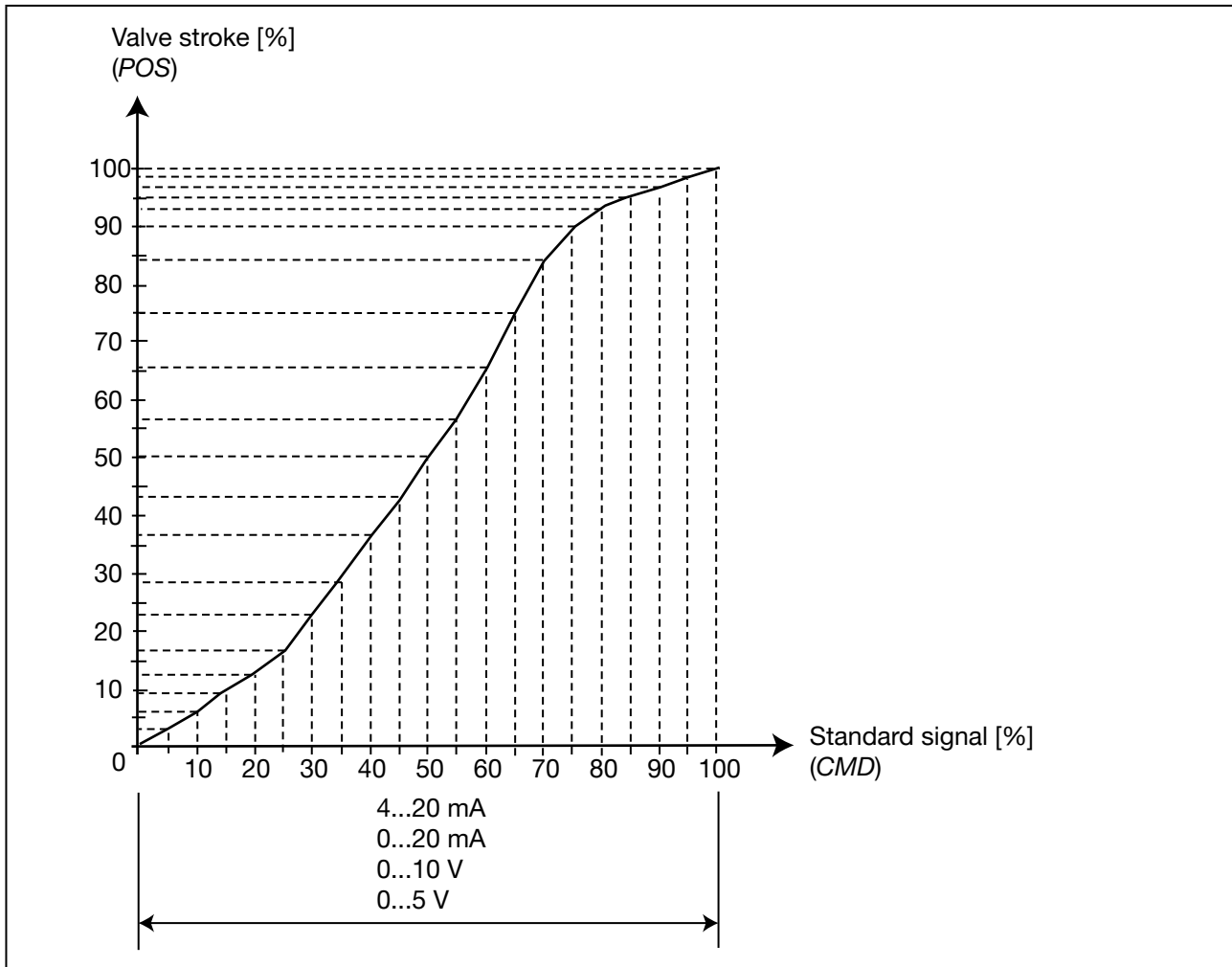


Fig. 54: Example of a programmed characteristic



In the section “[Tables for customer-specific settings](#)” in chapter “[39.1 Settings of the freely programmable characteristic](#)” there is a table in which you can enter your settings for the freely programmable characteristic.



### 25.2.2 CUTOFF – Sealing function

This function causes the valve to be sealed outside the control area.

This is where you input the limits for the position set-point value (CMD) as a percentage, from which the actuator is fully deaerated or aerated.

Controlled operation opens or resumes at a hysteresis of 1 %.

If the process valve is in the sealing area, the message „CUTOFF ACTIVE“ is indicated on the display.

**Only for type 8793:** Here you can select the set-point value to which the sealing function is to apply:

- Type PCO** Process set-point value (SP)
- Type XCO** Position set-point value (CMD)

If *Type PCO* was selected, the limits for the process set-point value (SP) are input as a percentage with reference to the scaling range.

Factory setting: *Min = 0 %;* *Max = 100 %;* *CUT type = Type PCO*

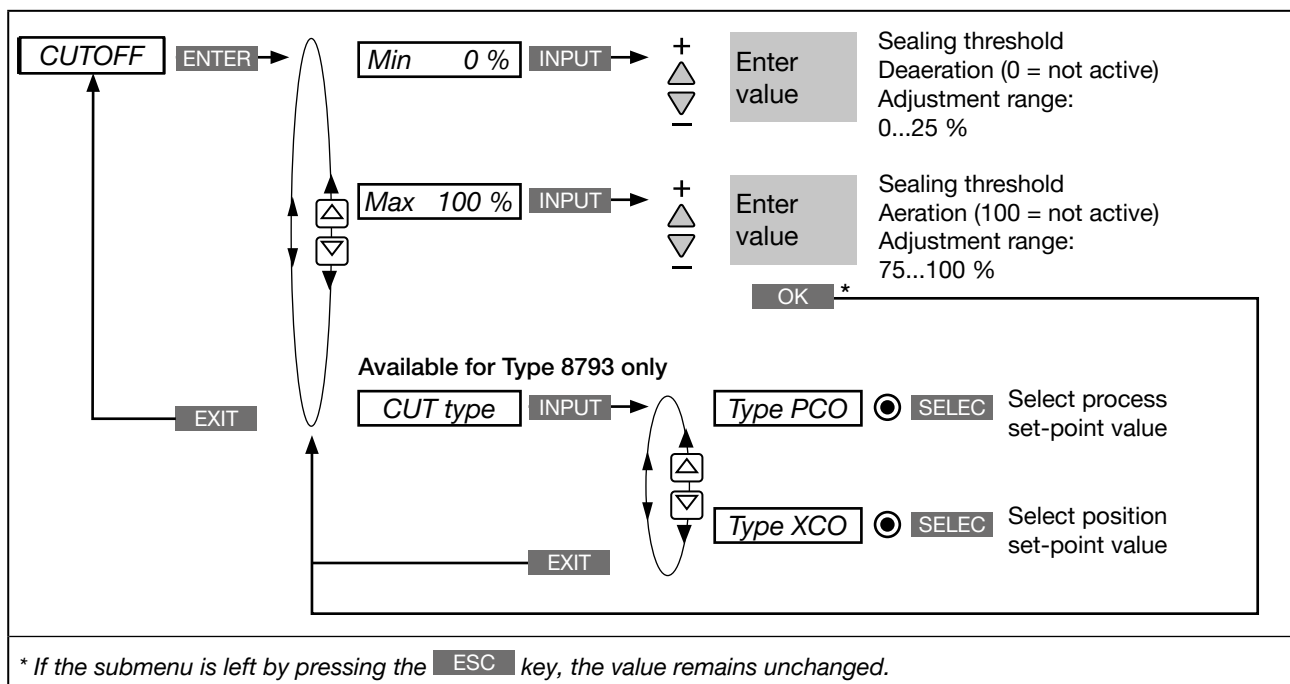


Fig. 55: Operating structure CUTOFF

**!** The changed data is saved in the memory (EEPROM) only when there is a switch to the process level, by leaving the main menu (MAIN) using the left selection key **EXIT**. During the save process, the save symbol on the display.

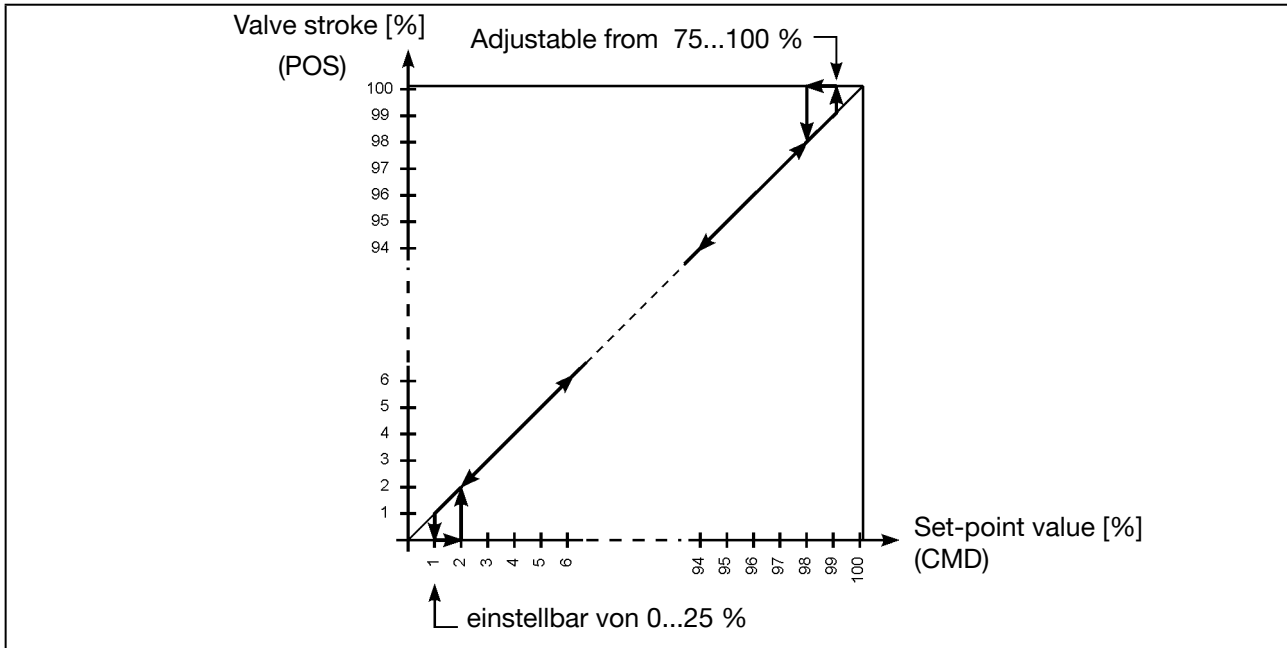


Fig. 56: Graph - CUTOFF;

### 25.2.3 DIR.CMD – Sense of effective direction of the positioner set-point value

Use this auxiliary function to set the sense of effective direction between the input signal (*INPUT*) and the nominal position (*CMD*) of the actuator.

**!** Each auxiliary function, which is to be set, must be incorporated initially into the main menu (MAIN). See Chapter “26.1 Activating and deactivating auxiliary functions”.

Factory setting: *Rise*

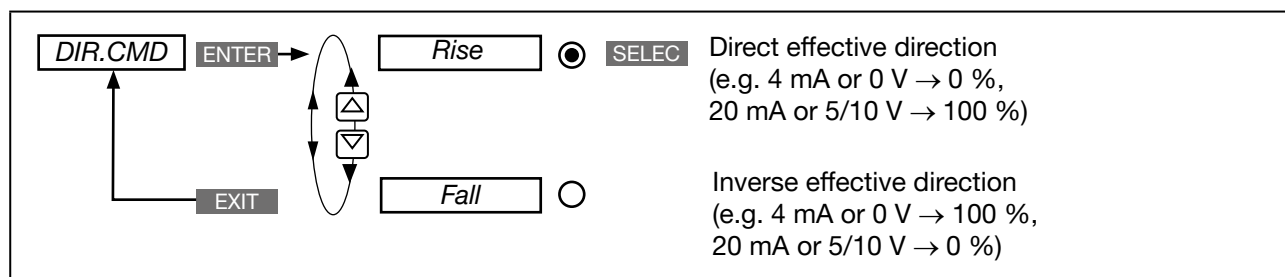


Fig. 57: Operating structure DIR.CMD

**!** The changed data is saved in the memory (EEPROM) only when there is a switch to the process level, by leaving the main menu (MAIN) using the left selection key **EXIT**. During the save process, the save symbol is indicated on the display.

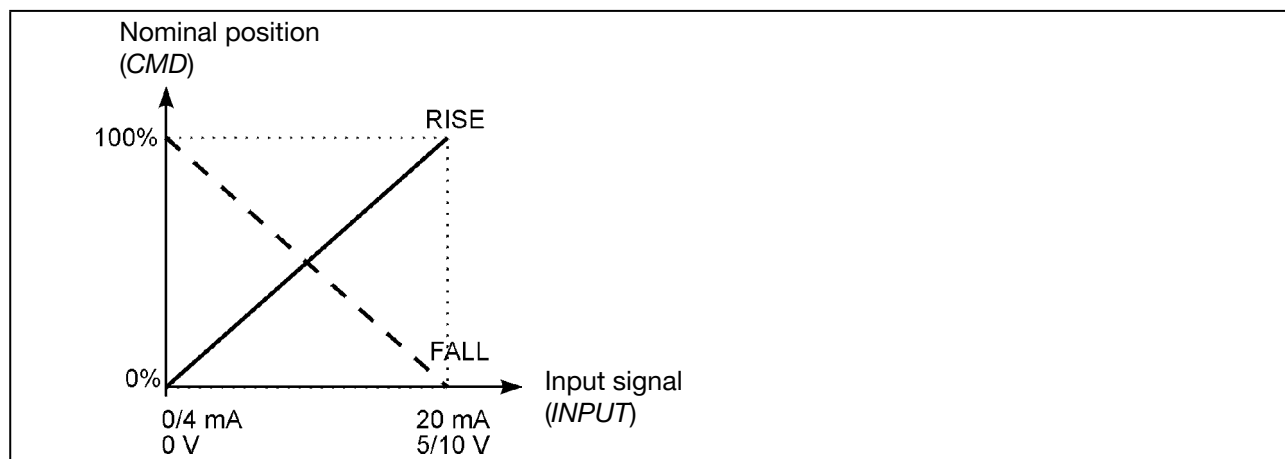


Fig. 58: Graph - DIR.CMD

MAN 1000118577 EN Version: K Status: RL (released | freigegeben) printed: 05.08.2022

### 25.2.4 DIR.ACT – Sense of effective direction of the actuator drive

Use this auxiliary function to set the sense of effective direction between the aeration state of the actuator and the actual position (POS).

Factory setting: *Rise*

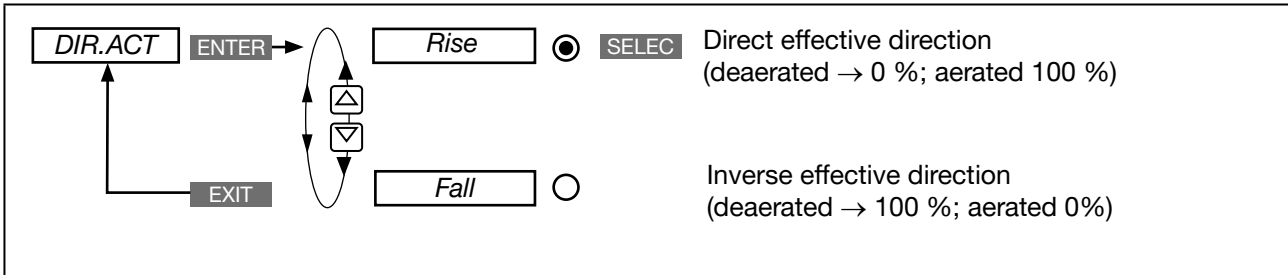


Fig. 59: Operating structure DIR.ACT



If the *Fall* function is selected, the description of the arrow keys (on the display) changes in the MANUAL operating state

OPN → CLS and CLS → OPN

The changed data is saved in the memory (EEPROM) only when there is a switch to the process level, by leaving the main menu (MAIN) using the left selection key EXIT. During the save process, the save symbol is indicated on the display.

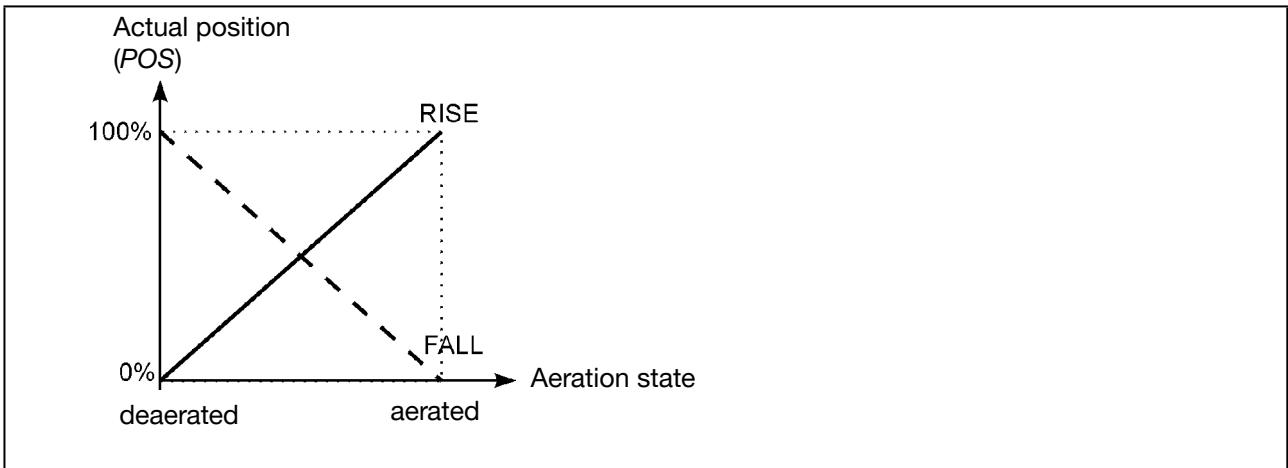


Fig. 60: Graph - DIR.ACT

### 25.2.5 SPLTRNG – Signal split range

Min. and max. values of the input signal as % for which the valve runs through the entire stroke range.

Factory setting:  $Min = 0\%$ ;  $Max = 100\%$



**Type 8793:** The *SPLTRNG* auxiliary function can only be selected when operating as a positioner.

*P.CONTROL* = not activated.

Use this auxiliary function to limit the position set-point value range of the Type 8792/8793 by specifying a minimum and a maximum value.

As a result, it is possible to divide a utilised standard signal range (4 – 20 mA; 0 – 20 mA; 0 – 10 V or 0 – 5 V) into several devices (without or with overlapping).

This allows several valves to be used **alternately** or in the case of overlapping set-point value ranges **simultaneously** as actuating element.

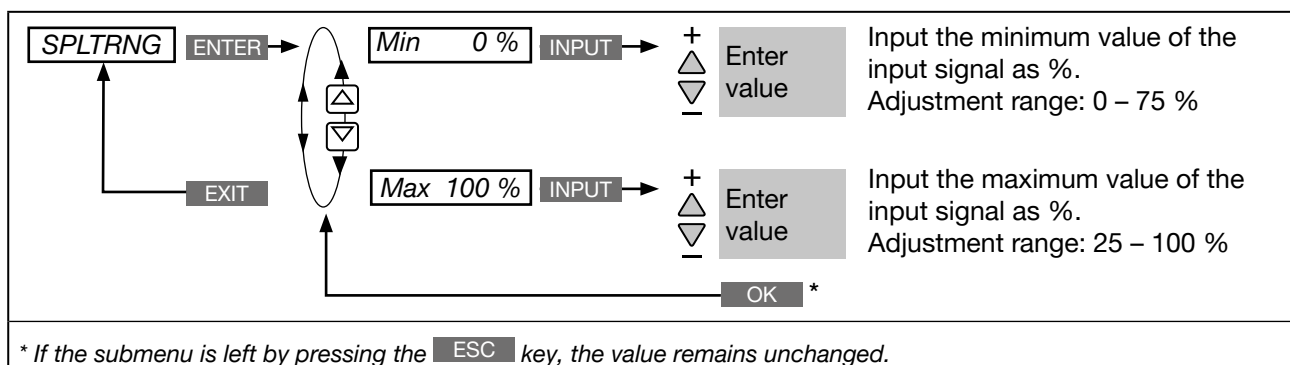


Fig. 61: Operating structure *SPLTRNG*



The changed data is saved in the memory (EEPROM) only when there is a switch to the process level, by leaving the main menu (MAIN) using the left selection key **EXIT**. During the save process, the save symbol is indicated on the display.

#### Splitting a standard signal range into two set-point value ranges

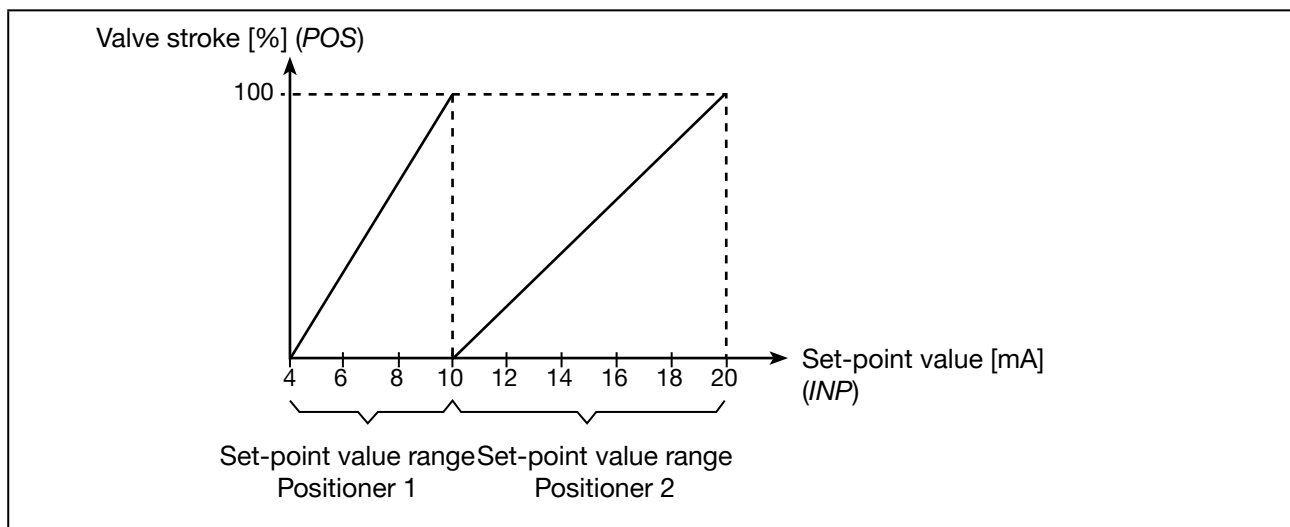


Fig. 62: Graph - *SPLTRNG*

### 25.2.6 X.LIMIT – Limits the mechanical stroke range

This auxiliary function limits the (physical) stroke to specified % values (minimum and maximum). In doing so, the stroke range of the limited stroke is set equal to 100 %.

If the limited stroke range is left during operation, negative POS values or POS values greater than 100 % are indicated.

Factory setting: *Min = 0 %*, *Max = 100 %*

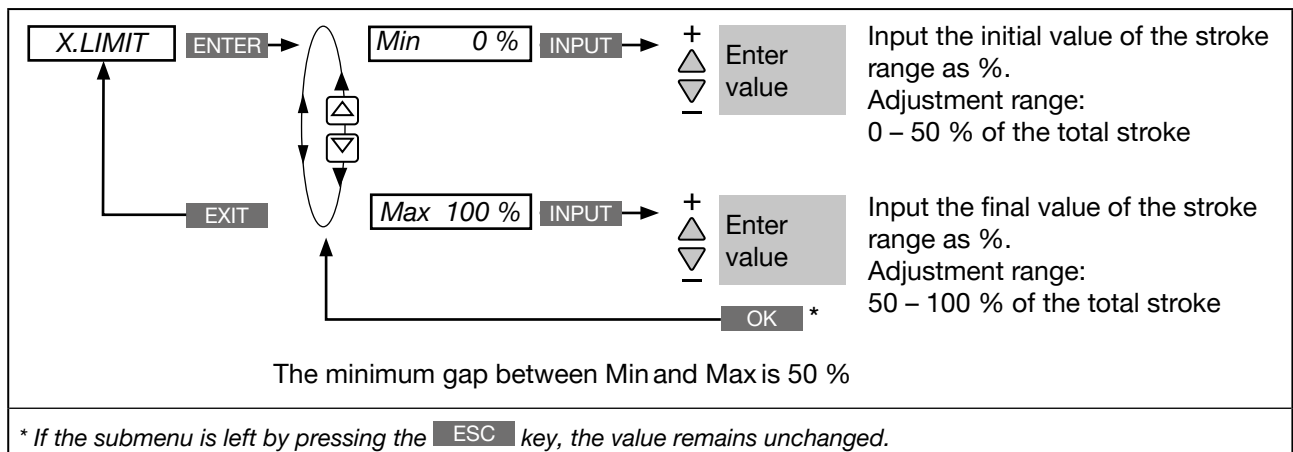



Fig. 63: Operating structure X.LIMIT

**!** The changed data is saved in the memory (EEPROM) only when there is a switch to the process level, by leaving the main menu (MAIN) using the left selection key **EXIT**. During the save process, the save symbol is indicated  on the display.

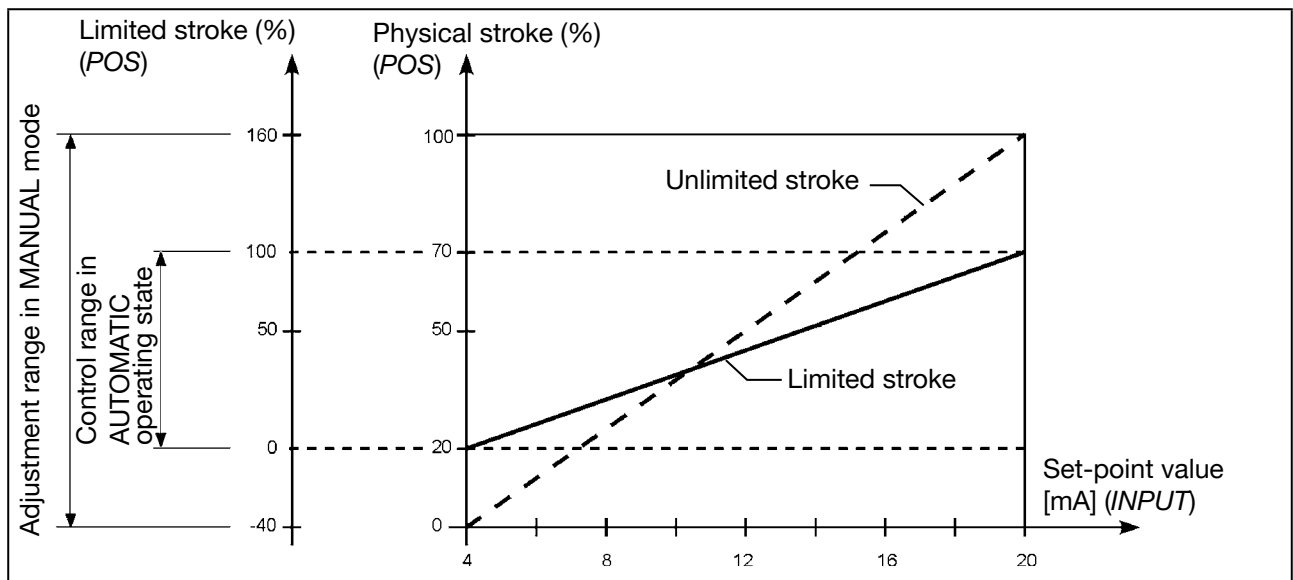


Fig. 64: Graph - X.LIMIT

### 25.2.7 X.TIME – Limiting the control speed

Use this auxiliary function to specify the opening and closing times for the entire stroke and limit the control speeds.

**!** When the X.TUNE function is running, the minimum opening and closing time for the entire stroke is automatically entered for *Open* and *Close*. Therefore, movement can be at maximum speed.

Factory setting: values determined at the factory by the X.TUNE

If the control speed is limited, values can be input for Open and Close which are between the minimum values determined by the X.TUNE and 60 s.

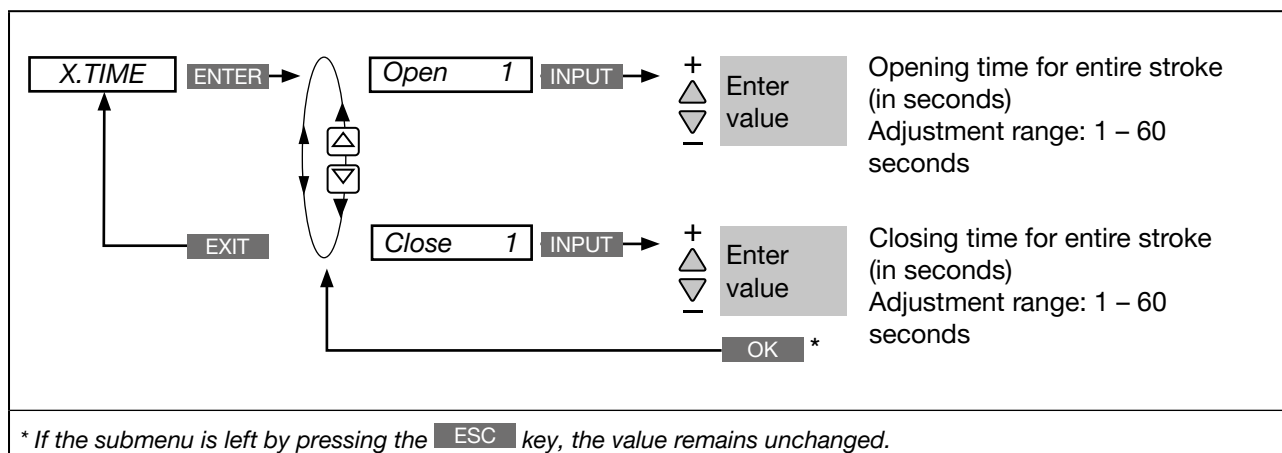


Fig. 65: Operating structure X.TIME

**!** The changed data is saved in the memory (EEPROM) only when there is a switch to the process level, by leaving the main menu (MAIN) using the left selection key **EXIT**. During the save process, the save symbol on the display.

#### Effect of limiting the opening speed when there is a jump in the set-point value

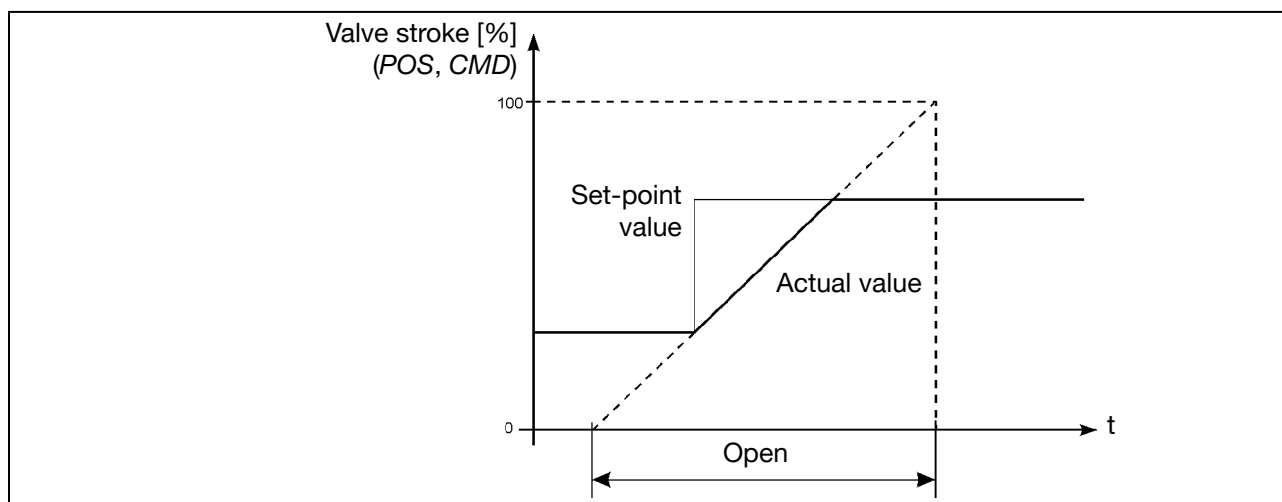


Fig. 66: Graph - X.TIME

## 25.2.8 X.CONTROL – Parameterization of the positioner

This function can be used to re-adjust the parameters of the positioner.  
The re-adjustment should only be made if it is required for the application.

The parameters for X.CONTROL are automatically set with the exception of DBND (dead band) when specifying the basic settings by running X.TUNE.

**!** If the setting for DBND (dead band depending on the friction behavior of the actuating drive) is also to be automatically determined when X.TUNE is running, X.CONTROL must be activated by incorporating it into the main menu (MAIN).

When X.TUNE is running, all previously re-adjusted values are overwritten (except the X.TUNE function was manually parameterized).

- DBND** Insensitivity range (dead band)
- KXopn** Amplification factor of the proportional portion (for aerating the valve)
- KXcls** Amplification factor of the proportional portion (for bleeding the valve)
- KDopn** Amplification factor of the differential portion (for aerating the valve)
- KDcls** Amplification factor of the differential portion (for bleeding the valve)
- YBfric** Friction correction (for aerating the valve)
- YEfric** Friction correction (for bleeding the valve)

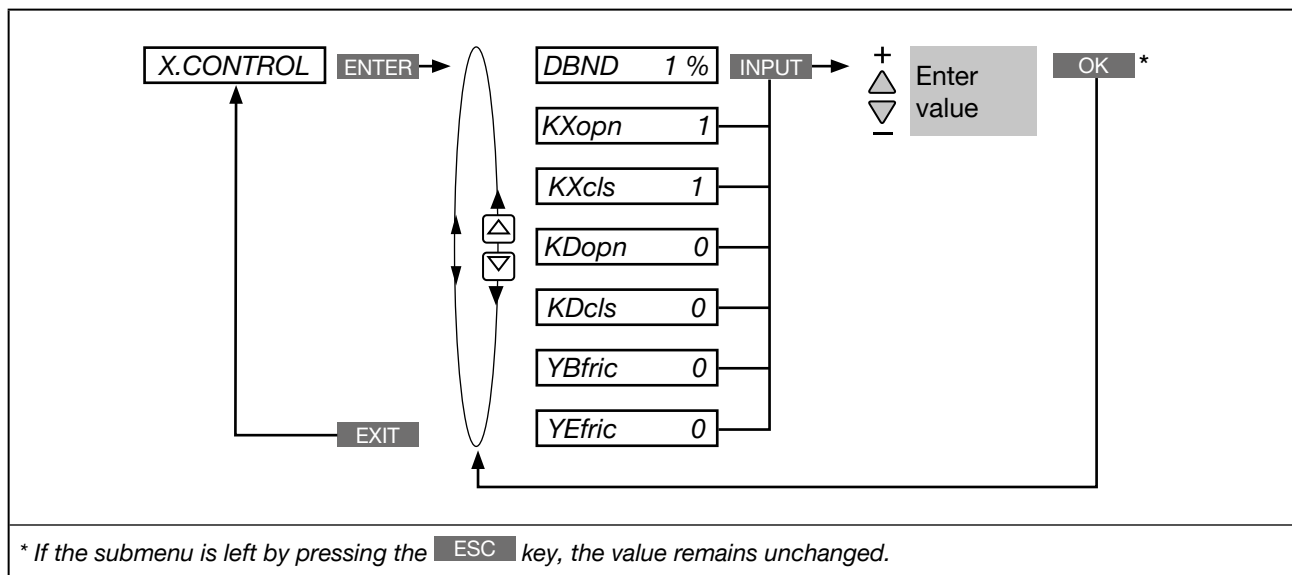


Fig. 67: Operating structure X.CONTROL

### DBND Insensitivity range (dead zone) of the positioner

Input the dead zone as %, relating to the scaled stroke range;  
i.e.  $X.LIMIT Max - X.LIMIT Min$  (see Auxiliary function “26.2.6 X.LIMIT – Limits the mechanical stroke range”).

This function causes the controller to respond only from a specific control difference; as a result the solenoid valves in the Type 8792/8793 and the pneumatic actuator are protected.



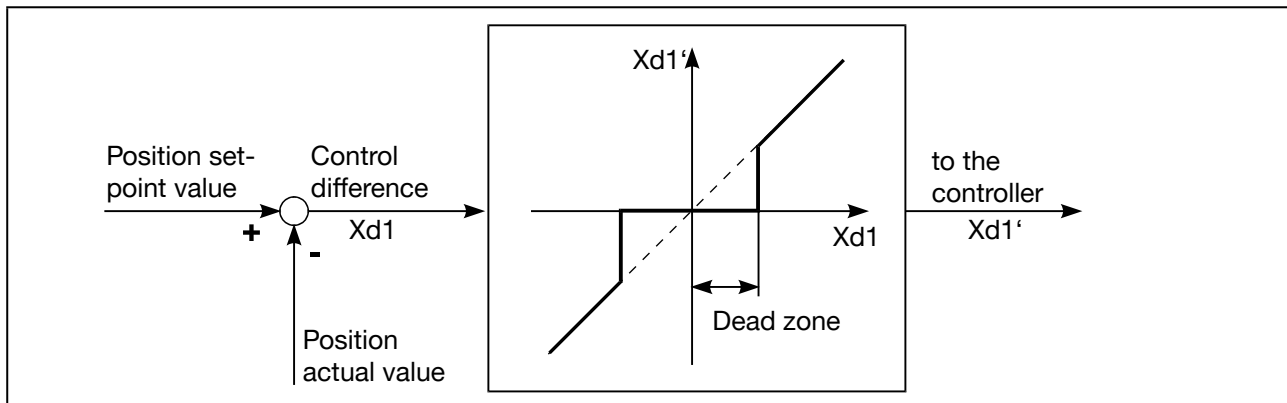


Fig. 68: Graph - X.CONTROL

### 25.2.9 P.CONTROL – Setting up and parameterization of the process controller

Parameterization of the process controller is described in Chapter [“25.1 P.CONTROL – Setting up and parameterization of the process controller”](#)

## 25.2.10 SECURITY – Code protection for the settings

Use the *SECURITY* function to prevent the Type 8792/8793 or individual functions from being accessed unintentionally.

Factory setting: Access Code: 0000

If the code protection is activated, the code (set access code or master code) must be input whenever operator action is disabled.

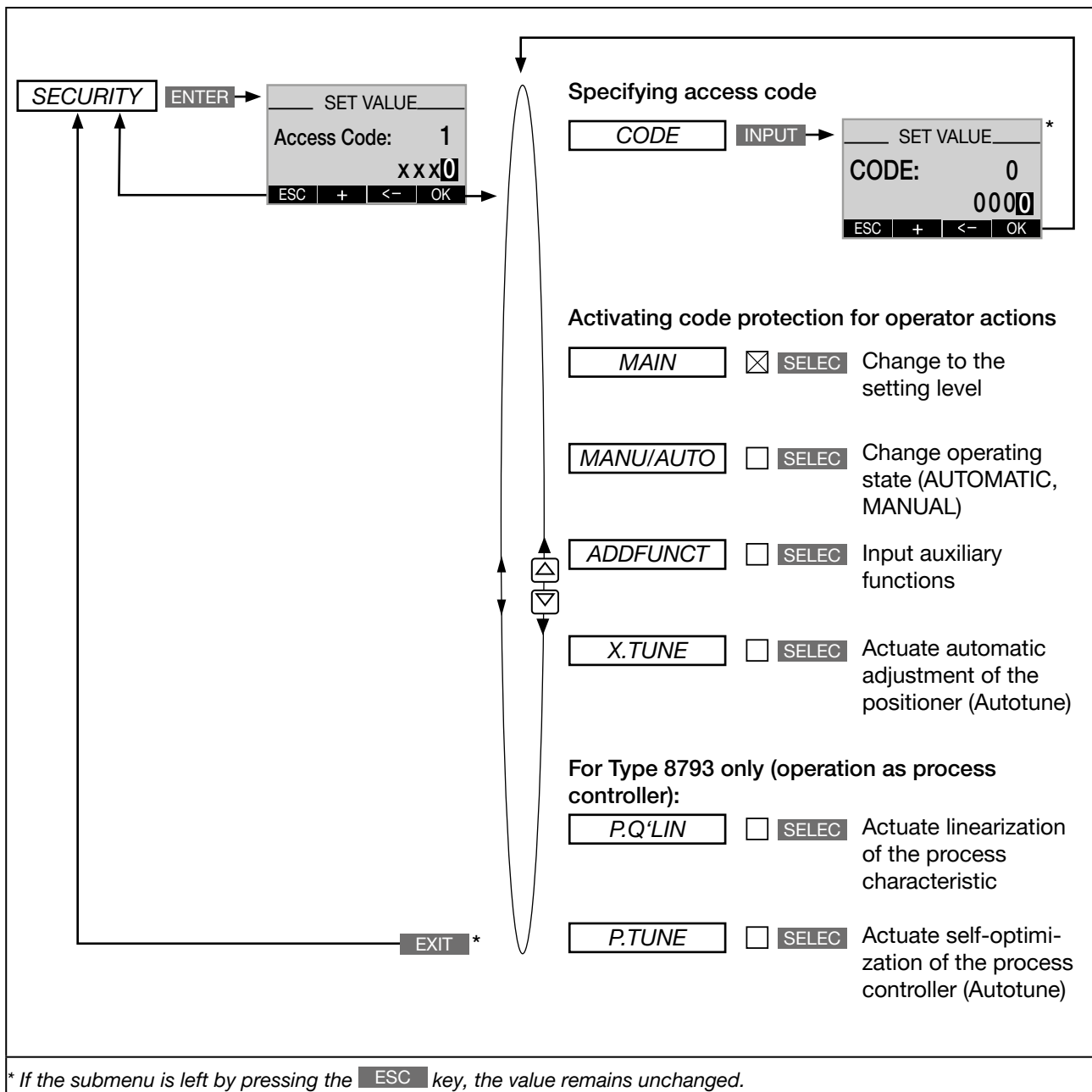


Fig. 69: Operating structure SECURITY

## Setting the code protection:
















Key	Action	Description
<b>MENU</b>	Press  for approx. 3 s	Switching from process level ⇔ setting level.
▲ / ▼	Select <b>SECURITY</b>	(To do this, the auxiliary function must be incorporated into the main menu).
<b>ENTER</b>	Press 	The input screen for the access code ( <i>Access Code</i> ) is displayed.
▲ / ▼	 Select decimal place  Increase number	Enter code. For the first setting: <i>Access Code</i> 0000 (factory settings) For activated code protection: <i>Access Code</i> from the user *
<b>OK</b>	Press 	The submenu of <b>SECURITY</b> is opened.
▲ / ▼	Select <b>CODE</b>	
<b>INPUT</b>	Press 	The input screen for specifying the access code ( <i>Access Code</i> ) is displayed.
▲ / ▼	 Select decimal place  Increase number	Enter required access code.
<b>OK</b>	Press 	Acknowledgment and return to the <b>SECURITY</b> menu.
▲ / ▼	select	Selector operator actions to which the code protection is to apply.
<b>SELEC</b>	Press 	Activate code protection by checking the box <input checked="" type="checkbox"/> .
<b>EXIT</b>	Press 	Acknowledgment and simultaneous return to the main menu (MAIN).
<b>EXIT</b>	Press 	Switching from setting level ⇔ process level.

Table 56: **SECURITY**; setting code protection

 The changed data is saved in the memory (EEPROM) only when there is a switch to the process level, by leaving the main menu (MAIN) using the left selection key **EXIT**. During the save process, the save symbol is indicated  on the display.

 \* If you have forgotten the set code:  
All operator actions can be implemented with the non-changeable master code. This 4-digit master code can be found in the printed brief instructions for Type 8792/8793.

## 25.2.11 SAFEPOS – Input the safety position

This function specifies the actuator safety position which is started at defined signals.



The set safety position is only started

- if there is a corresponding signal on the binary input (Configuration see *chapter “26.2.13 BINARY.IN – Activation of the binary input”*) or
- if a signal fault occurs (Configuration see *chapter “26.2.12 SIG.ERROR – Configuration of signal level fault detection”*).

In the case of the bus version (PROFIBUS) the safety position is also started with

- corresponding parameter telegram
- *BUS ERROR* (adjustable)

If the mechanical stroke range is limited with the *X.LIMIT* function, only safety positions within these limits can be started.

This function is executed in AUTOMATIC mode only.

Factory setting: 0 %

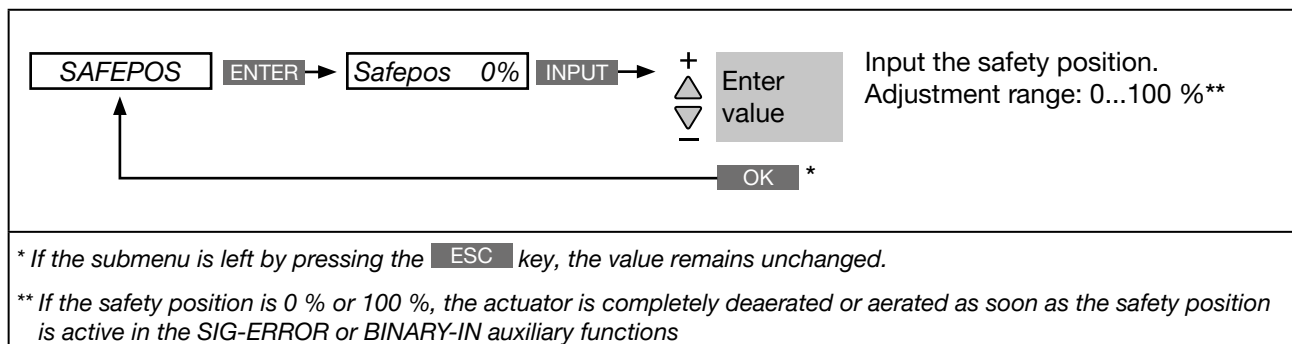


Fig. 70: Operating structure SAFEPOS



The changed data is saved in the memory (EEPROM) only when there is a switch to the process level, by leaving the main menu (MAIN) using the left selection key **EXIT**. During the save process, the save symbol on the display.

## 25.2.12 SIG.ERROR – Configuration of signal level fault detection

The SIG-ERROR function is used to detect a fault on the input signal.

If signal fault detection is activated, the respective fault is indicated on the display.  
(See chapter “32.1 Error messages on the display”.)

A fault detection on the input signal is only possible for signal types 4 -20 mA and Pt 100.  
The particular menu branch is hidden for other signal types.

- **4 - 20 mA:** Fault if input signal ( $\leq 3.5 \text{ mA}$  ( $\pm 0.5 \%$  of final value, hysteresis  $0.5 \%$  of final value))
- **Pt 100** (can be set for process controller Type 8793 only):  
Fault if input signal  $225 \text{ }^\circ\text{C}$  ( $\pm 0.5 \%$  of final value, hysteresis  $0.5 \%$  of final value)



The signal type is set in the following menus:

1. **INPUT** (for Types 8792 and 8793):  
See Chapter “23.1 INPUT - Setting the input signal”.
2. **P.CONTROL** (for Type 8793 and when process controller activated):  
See Chapter “25.2.1 PV-INPUT – Specifying signal type for the process actual value”

NOTE: The fault detection is only possible if the external set-point value default was selected in SP-INPUT. See Chapter “25.2.3 SP-INPUT – Type of the set-point value default (intern or extern)”.

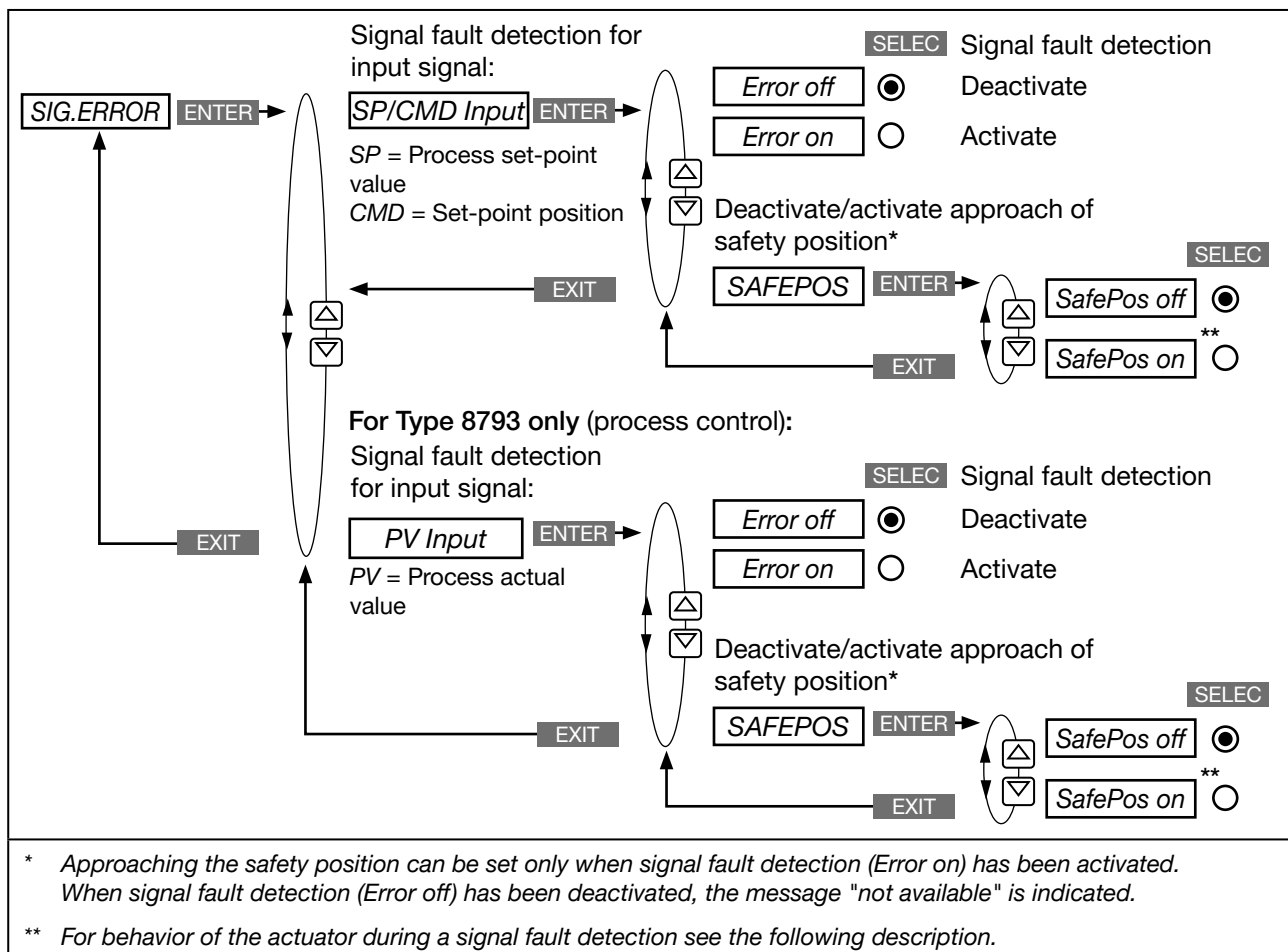


Fig. 71: Operating structure SIG-ERROR

### 25.2.12.1. Behavior of the actuator when safety position deactivated or activated

Selection **SafePos off**  – The actuator remains in the position which corresponds to the set-point value last transferred (default setting).

Selection **SafePos on**  – Approaching the safety position activated:

In the event of a signal fault detection, the behavior of the actuator depends on the activation of the **SAFEPOS** auxiliary function. See Chapter “26.2.11 SAFEPOS – Input the safety position”.

- **SAFEPOS** activated: In the event of a signal fault detection the actuator moves to the position which is specified in the **SAFEPOS** auxiliary function.
- **SAFEPOS** not activated: The actuator moves to the safety end position which it would assume if the electrical and pneumatic auxiliary power failed. See Chapter “10.9 Safety end positions after failure of the electrical or pneumatic auxiliary power”.



The activation for approaching the safety position (selection *SafePos on*) is possible only when signal fault detection has been activated (*ERROR on*).

### 25.2.13 BINARY.IN – Activation of the binary input

The binary input is configured in this menu. The following functions can be assigned to it:

- SafePos** Approaching *SafePos*
- Manu/Auto** Switching over the operating state (MANUAL / AUTOMATIC)
- X.TUNE** Starting the function *X.TUNE*

Only for type 8793 and when process controller activated:

- X.CO/P.CO** Switching between position and process controller

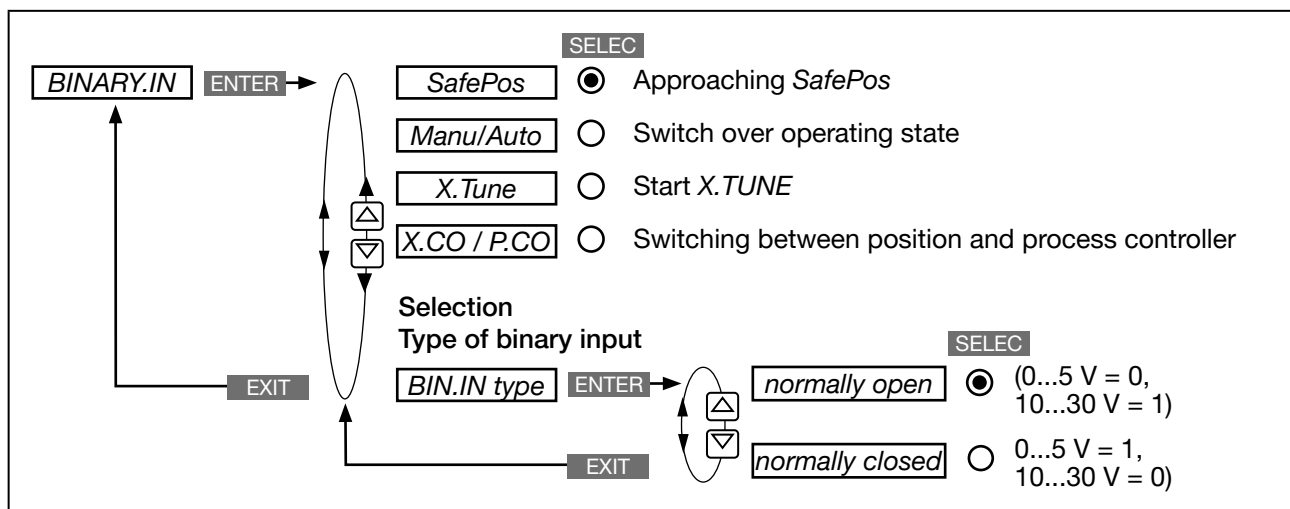


Fig. 72: Operating structure **BINARY.IN**

### SafePos – Approaching a safety position:

The behavior of the actuator depends on the activation of the *SAFEPOS* auxiliary function. See Chapter “[26.2.11 SAFEPOS – Input the safety position](#)”.

*SAFEPOS* activated: The actuator moves to the safety position which is specified in the *SAFEPOS* auxiliary function.

*SAFEPOS* deactivated: The actuator moves to the safety end position which it would assume if the electrical and pneumatic auxiliary power failed. See Chapter “[10.9 Safety end positions after failure of the electrical or pneumatic auxiliary power](#)”.

Binary input = 1 → Actuator moves to the set safety position.

### Manu/Auto – Switching between the MANUAL and AUTOMATIC operating states:

Binary input = 0 → Operating state AUTOMATIC **AUTO**

Binary input = 1 → Operating state MANUAL **MANU**



If the *Manu/Auto* function was selected in the *BINARY.IN* menu, it is no longer possible to change the operating state on the process level using the keys **MANU** and **AUTO**.

### X.TUNE – Starting the function X.TUNE:

Binary input = 1 → Starting *X.TUNE*

### X.CO/P.CO – Switching between position and process controller:

This menu option stands only for Type 8793 and is available when process controller (*P.CONTROL*) has been activated.

Binary input = 0 → Positioner (*X.CO*)

Binäreingang = 1 → Process controller (*P.CO*)

### 25.2.14 OUTPUT – Configuring the outputs (option)

**!** The *OUTPUT* menu option is only indicated in the selection menu of *ADD.FUNCTION* if the Type 8792/8793 has outputs (option).

The Type 8792/8793 which has the outputs option is available in the following versions:

- one analogue output
- one analogue and two binary outputs
- two binary outputs

**!** According to the version of the Type 8792/8793 only the possible adjustable outputs (*ANALOGUE*, *ANALOGUE + BIN 1 + BIN 2* or *BIN 1 + BIN 2*) are indicated in the *OUTPUT* menu option.

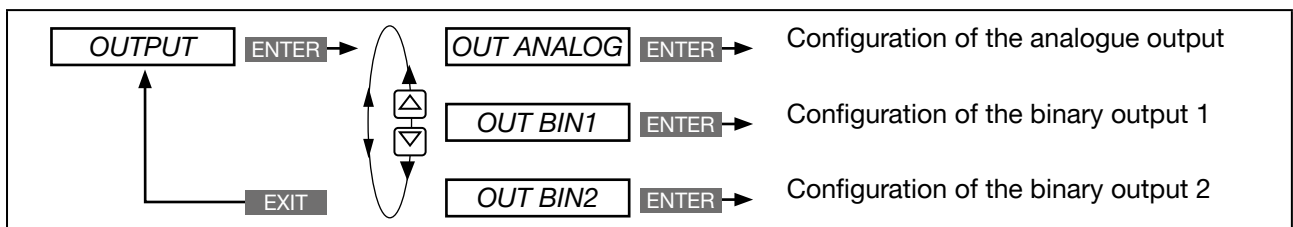


Fig. 73: Operating structure *OUTPUT*;

#### 25.2.14.1. *OUT ANALOG* - Configuring the analogue output

**Type 8792:** The feedback of the current position (*POS*) or of the set-point value (*CMD*) can be transmitted to the control center via the analog output.

**Type 8793:** The feedback of the current position (*POS*) or of the set-point value (*CMD*), of the process actual value (*PV*) or of the process set-point value (*SP*) can be transmitted to the control center via the analog output.

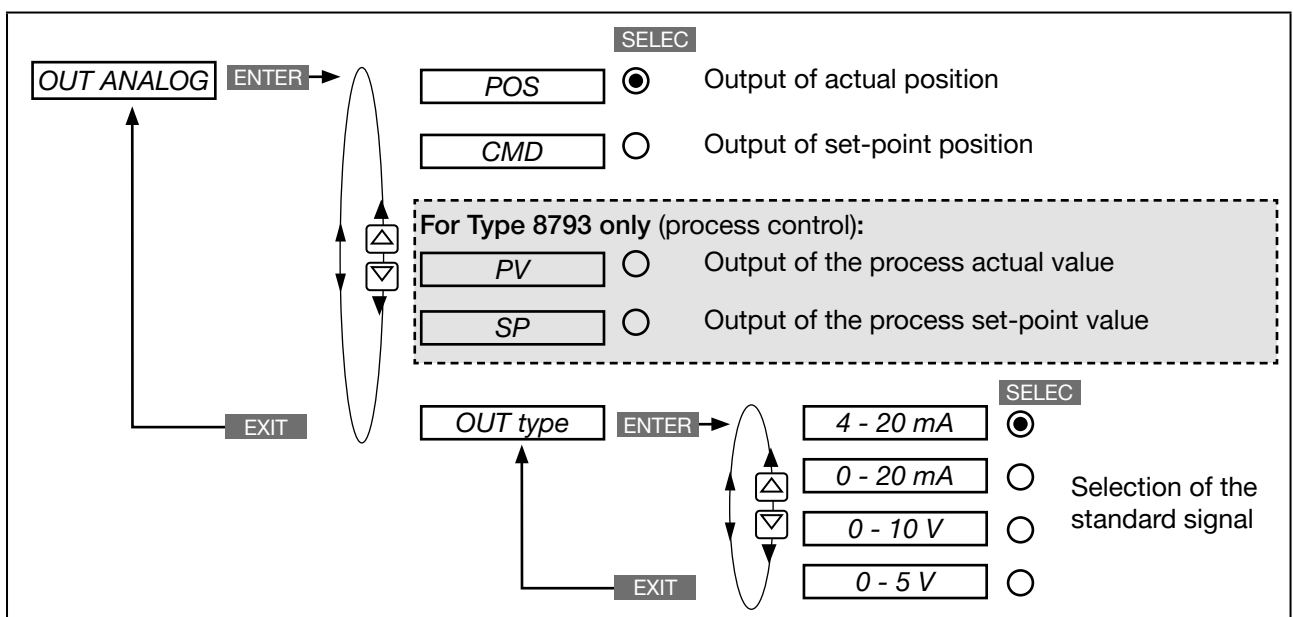


Fig. 74: Operating structure *OUTPUT-ANALOG*;



### 25.2.14.2. OUT BIN1 / OUT BIN2 - Configuring the binary outputs

The following description is valid for both binary outputs *OUT BIN 1* and *OUT BIN 2*, as the operation in the menu is identical.

The binary outputs 1 and 2 can be used for one of the following outputs:

<b>POS.Dev</b>	Exceeding the permitted control deviation
<b>POS.Lim-1/2</b>	Current position with respect to a specified limit position (> or <)
<b>Safepos</b>	Actuator in safety position
<b>ERR.SP/CMD</b>	Sensor break (SP = process set-point value / CMD = set-point value position)
<b>ERR.PV</b>	Sensor break (process actual value). <b>Available for Type 8793 only.</b>
<b>Remote</b>	Operating state (AUTOMATIC / MANUAL)
<b>Tune.Status</b>	Status <i>X.TUNE</i> (process optimization)
<b>DIAG.State-1/2</b>	Diagnosis output (option)

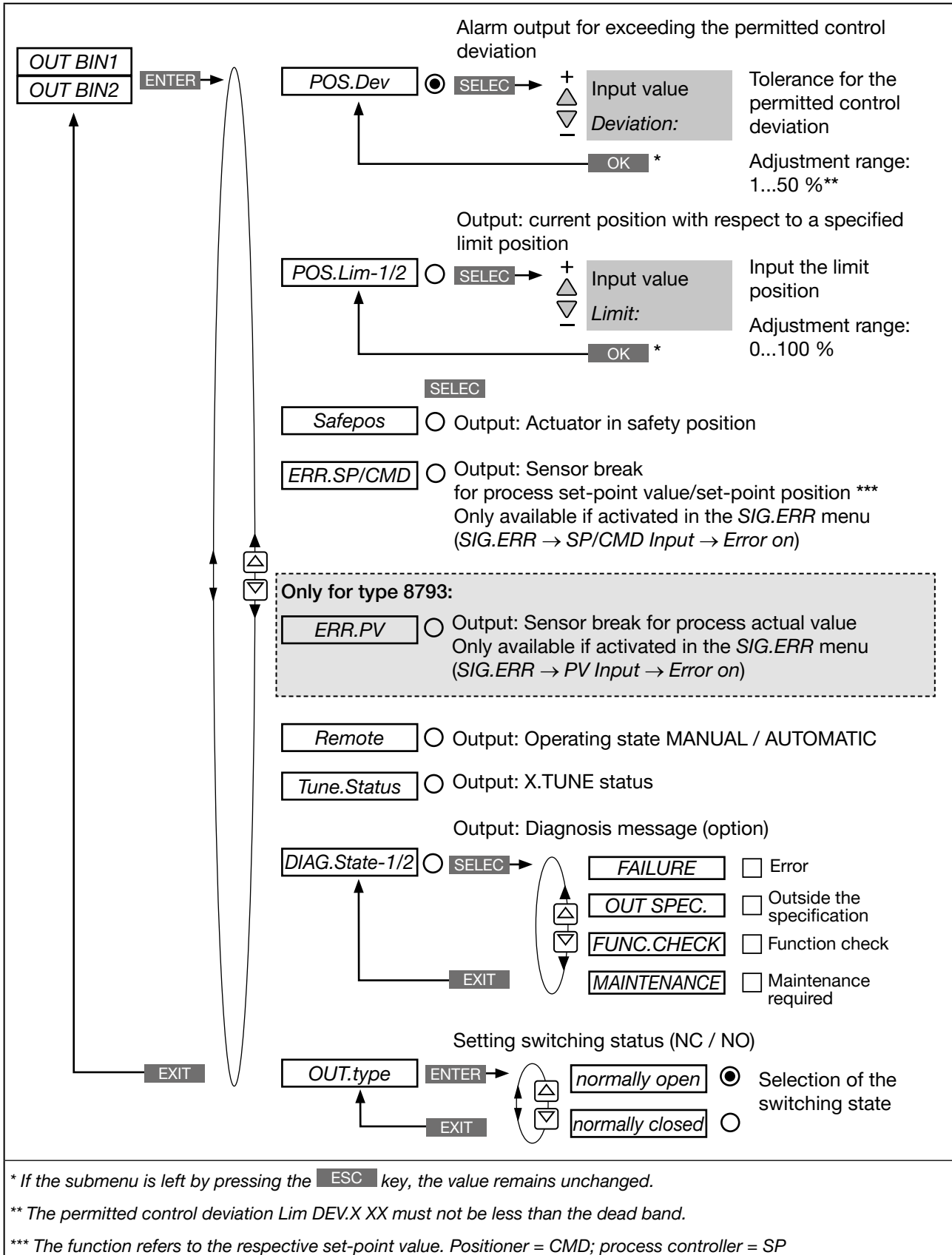
Overview of possible outputs and associated switching signals:

Menu option	Switching signal	Description
<b>POS.Dev</b>	0	Control deviation is within the set limit.
	1	Control deviation is outside the set limit.
<b>POS.Lim-1/2</b>	0	Actual position is above the limit position.
	1	Actual position is below the limit position.
<b>Safepos</b>	0	Actuator is not in the safety position.
	1	Actuator is in the safety position.
<b>ERR.SP/CMD</b>	0	No sensor break available.
<b>ERR.PV</b>	1	Sensor break available.
<b>Remote</b>	0	Appliance is the AUTOMATIC operating state.
	1	Appliance is the MANUAL operating state.
<b>Tune.Status</b>	0	The <i>X.TUNE</i> function is currently not running.
	1	The <i>X.TUNE</i> function is currently running.
	0/1 alternating (10 s)	The <i>X.TUNE</i> function was stopped during execution by a fault.
<b>DIAG.State-1/2</b>	0	No diagnosis message available for the selected status signals.
	1	Diagnosis message available for the selected status signals.

Table 57: OUT BIN 1/2; Possible outputs and associated switching signals

Switching signal	Switching statuses	
	normally open	normally closed
0	0 V	24 V
1	24 V	0 V

Table 58: OUT BIN 1/2; switching statuses



MAN 1000118577 EN Version: K Status: RL (released | freigegeben) printed: 05.08.2022

Fig. 75: Operating structure OUTPUT-BIN1/BIN2

### 25.2.14.3. Setting of the submenu options of *OUT BIN 1 / OUT BIN 2*




Key	Action	Description
<b>MENU</b>	Press  for approx. 3 s	Switching from process level ⇔ setting level.
▲ / ▼	Select <i>OUTPUT</i>	(To do this, the auxiliary function must be incorporated into the main menu).
<b>ENTER</b>		The outputs are displayed.
▲ / ▼	Select <i>OUT BIN1/2</i>	
<b>ENTER</b>	Press 	Submenu options of <i>OUT BIN 1/2</i> are displayed.

Table 59: *OUT BIN 1 / OUT BIN 2*; opening the submenu

- *POS.Dev* - Alarm output for excessively large control deviation of the positioner
- *POS.Lim-1/2* - Output of the current position with respect to a specified limit position









Key	Action	Description
<i>POS.Dev</i> - Alarm output for excessively large control deviation of the positioner:		
▲ / ▼	Select <i>POS.Dev</i>	
<b>SELEC</b>	Press 	The input screen for the limit value ( <i>Deviation:</i> ) is opened.
▲ / ▼	 Increase value  Reduce value	Input limit value for permitted control deviation. Adjustment range: 1...50 % (must not be less than the dead band).
<b>OK</b>	Press 	Acknowledgment and simultaneous return to the <i>OUT BIN 1/2</i> menu. Then set the required switching status in the <i>OUT.type</i> submenu.
<i>POS.Lim-1/2</i> - Output of the current position with respect to a specified limit position:		
▲ / ▼	Select <i>POS.Lim-1/2</i>	
<b>SELEC</b>	Press 	The input screen for the limit position ( <i>Limit:</i> ) is opened.
▲ / ▼	 Increase value  Reduce value	Input limit position. Adjustment range: 0...100 %.
<b>OK</b>	Press 	Acknowledgment and simultaneous return to the <i>OUT BIN 1/2</i> menu. Then set the required switching status in the <i>OUT.type</i> submenu.

Table 60: *OUT BIN 1 / OUT BIN 2*; setting value for *POS.Dev* or *POS.Lim-1/2*

- **Safepos** - Outputting the message: Actuator in safety position
- **ERR.SP/CMD** - Outputting the message: Sensor break for process set-point value/set-point position  
Only available if the function in the *SIG.ERR* menu has been activated (*SIG.ERR* → *SP/CMD input* → *Error on*).  
See Chapter “26.2.12 SIG.ERROR – Configuration of signal level fault detection”.
- **ERR.PV** - Outputting the message: Sensor break for process actual value (only for Type 8793)  
Only available if the function in the *SIG.ERR* menu has been activated (*SIG.ERR* → *PV Input* → *Error on*).  
See Chapter “26.2.12 SIG.ERROR – Configuration of signal level fault detection”.
- **Remote** - Output AUTOMATIC / MANUAL operating state
- **Tune.Status** - Output TUNE (process optimization)


Key	Action	Description
▲ / ▼	Select submenu option	( <i>Safepos</i> , <i>ERR.SP/CMD</i> , <i>ERR.PV</i> , <i>Remote</i> or <i>Tune.Status</i> ).
SELEC	Press 	Acknowledge submenu option as output function for the binary output. The selection is marked by a filled circle ●. Then set the required switching status in the <i>OUT.type</i> submenu.

Table 61: *OUT BIN1 / OUT BIN2*; specifying *Safepos*, *ERR.SP/CMD*, *ERR.PV*, *Remote* or *Tune.Status* as output.

- **DIAG.State-1/2** - Diagnosis output (option)  
Outputting the message: Diagnosis message from selected status signal  
For description see Chapter “26.2.22 DIAGNOSE – Menu for monitoring valves (option)”.




Key	Action	Description
▲ / ▼	Select <i>DIAG.State-1/2</i>	
SELEC	Press 	The status signals, which can be activated for outputting the message, are displayed.
▲ / ▼	Select status signal	Select the status signal which is to be assigned to the diagnosis output.
SELEC	Press 	Activate the selection by checking the box <input checked="" type="checkbox"/> or deactivate it by unchecking the box <input type="checkbox"/> .
		If required, activate further status signals for the diagnosis output by pressing the ▲ / ▼ and SELEC keys.
EXIT	Press 	Acknowledgment and simultaneous return to the <i>OUT BIN 1/2</i> menu. Then set the required switching status in the <i>OUT.type</i> submenu.

Table 62: *OUT.type*; inputting switching status for binary output and return to the process level.

- **OUT.type** - Setting the switching status

In addition to selecting the output, the switching status required for the binary output must be input. See "Table 64".








Key	Action	Description
▲ / ▼	Select <i>OUT.type</i>	
SELEC	Press 	The switching statuses <i>normally open</i> and <i>normally closed</i> are displayed.
▲ / ▼	Select switching status	
SELEC	Press 	The selection is marked by a filled circle ●.
EXIT	Press 	Acknowledgment and simultaneous return to the <i>OUT BIN 1/2</i> menu.
EXIT	Press 	Acknowledgment and simultaneous return to the <i>OUTPUT</i> menu.
EXIT	Press 	Acknowledgment and simultaneous return to the main menu (MAIN).
EXIT	Press 	Switching from setting level $\Rightarrow$ process level.

Table 63: *OUT.type*; inputting switching status for binary output and return to the process level.

Switching signal	Switching statuses	
	normally open	normally closed
0	0 V	24 V
1	24 V	0 V

Table 64: *OUT BIN 1/2*; switching statuses



The changed data is saved in the memory (EEPROM) only when there is a switch to the process level, by leaving the main menu (MAIN) using the left selection key **EXIT**. During the save process, the save symbol  on the display.

## 25.2.15 CAL.USER – Calibration of actual value and set-point value

The following values can be manually calibrated with this function:

- Position actual value **calibr. POS** (0 - 100 %)
- Position set-point value **calibr. INP** (4 - 20 mA, 0 - 20 mA, 0 - 5 V, 0 - 10 V)  
For the calibration process the signal type is displayed which was specified for the input signal.  
See Chapter [“23.1 INPUT - Setting the input signal”](#).

### Type 8793:

The following values can be calibrated only for Type 8793 and activated process controller (*P.CONTROL*).

- Process set-point value **calibr. SP** (4 - 20 mA, 0 - 20 mA, 0 - 5 V, 0 - 10 V)  
For the calibration process the signal type is displayed which was specified for the input signal.  
See Chapter [“23.1 INPUT - Setting the input signal”](#).



The calibration of the process set-point value is only possible if the external set-point value default was selected when setting up the process controller.  
See Chapter [“25.2.3 SP-INPUT – Type of the set-point value default \(intern or extern\)”](#).  
Setting: *P.CONTROL* → *SETUP* → *SP-INPUT* → *external*

- Process actual value **calibr. PV** (4 - 20 mA or \*C)  
For the calibration process the signal type is displayed which was specified for the process actual value when setting up the process controller.  
See Chapter [“25.2.1 PV-INPUT – Specifying signal type for the process actual value”](#)



The frequency signal type (flow rate) cannot be calibrated.  
If the frequency was set when setting up the process controller (*P.CONTROL* → *SETUP* → *PV-INPUT* → *Frequency*), the *calibr. PV* menu option is hidden.

MAN 1000118577 EN Version: K Status: RL (released | freigegeben) printed: 05.08.2022

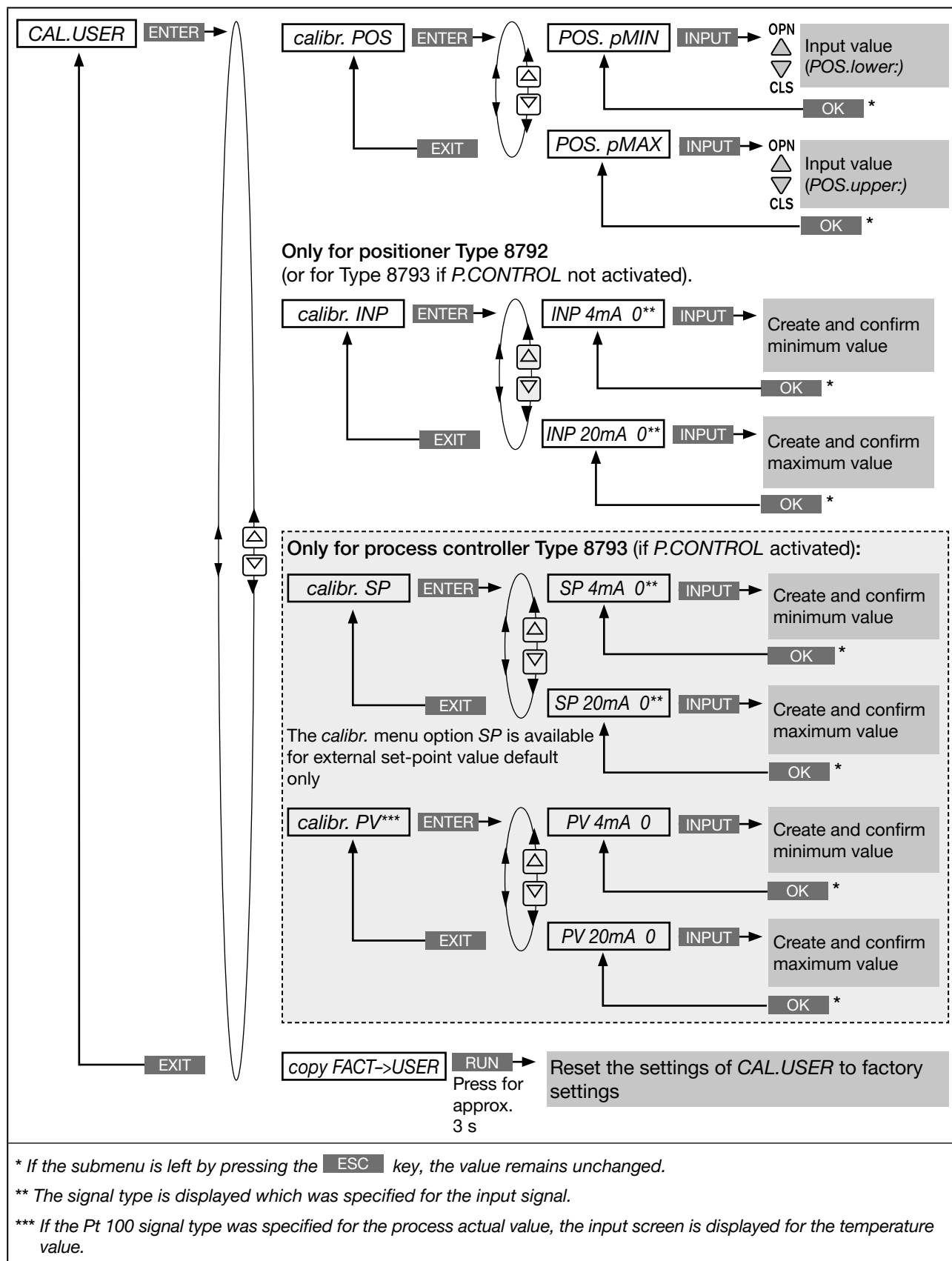


Fig. 76: Operating structure CAL.USER

### 25.2.15.1. Calibration of the position actual value and the position set-point value




























Key	Action	Description
<b>MENU</b>	Press  for approx. 3 s	Switching from process level $\Rightarrow$ setting level.
$\blacktriangle / \blacktriangledown$	Select <i>CAL.USER</i>	(To do this, the auxiliary function must be incorporated into the main menu).
<b>ENTER</b>		The submenu options are displayed.
<i>calibr. POS</i> - Calibration of the position actual value (0 - 100 %):		
$\blacktriangle / \blacktriangledown$	Select <i>calibr.POS</i>	
<b>ENTER</b>	Press 	The menu options for the minimum and the maximum position actual values are displayed.
$\blacktriangle / \blacktriangledown$	Select <i>POS. pMin</i>	
<b>INPUT</b>	Press 	The input screen for the lower value ( <i>POS.lower</i> ) is opened.
$\blacktriangle / \blacktriangledown$	<b>OPN</b> Open more <b>CLS</b> Close more	Approach minimum position of the valve.
<b>OK</b>	Press 	Transfer and simultaneous return to the <i>calibr.POS</i> menu.
$\blacktriangle / \blacktriangledown$	Select <i>POS. pMax</i>	
<b>INPUT</b>	Press 	The input screen for the upper value ( <i>POS.upper</i> ) is opened.
$\blacktriangle / \blacktriangledown$	<b>OPN</b> Open more <b>CLS</b> Close more	Approach maximum position of the valve.
<b>OK</b>	Press 	Transfer and simultaneous return to the <i>calibr.POS</i> menu.
<b>EXIT</b>	Press 	Acknowledgment and simultaneous return to the <i>CAL.USER</i> menu.
<i>calibr. INP</i> calibration of the position set-point value (4...20 mA; 0...20 mA; 0...5 V, 0...10 V):		
$\blacktriangle / \blacktriangledown$	Select <i>calibr.INP</i>	
<b>ENTER</b>	Press 	The menu options for the minimum and maximum value of the input signal are displayed.
$\blacktriangle / \blacktriangledown$	Select <i>INP 0mA (4mA/0V)</i>	The minimum value for the input signal is displayed.
-	-	Apply the minimum value to the input.
<b>OK</b>	Press 	Transfer and simultaneous return to the <i>calibr.INP</i> menu.
$\blacktriangle / \blacktriangledown$	Select <i>INP 20mA (5V/10V)</i>	The maximum value for the input signal is displayed.
-	-	Apply the maximum value to the input.
<b>OK</b>	Press 	Transfer and simultaneous return to the <i>calibr.INP</i> menu.
<b>EXIT</b>	Press 	Acknowledgment and simultaneous return to the <i>CAL.USER</i> menu.
<b>EXIT</b>	Press 	Acknowledgment and simultaneous return to the main menu (MAIN).
<b>EXIT</b>	Press 	Switching from setting level $\Rightarrow$ process level.

 Table 65: *CAL.USER*; calibration of position actual value and position set-point value



### 25.2.15.2. Calibration of the process set-point value and process actual value

Key	Action	Description
<b>MENU</b>	Press  for approx. 3 s	Switching from process level ⇔ setting level.
▲ / ▼	Select <i>CAL.USER</i>	(To do this, the auxiliary function must be incorporated into the main menu).
<b>ENTER</b>		The submenu options are displayed.
<i>calibr. SP</i> - calibration of the process set-point value:		
▲ / ▼	Select <i>calibr.SP</i>	
<b>ENTER</b>	Press 	The menu options for the minimum and the maximum process set-point values are displayed.
▲ / ▼	Select <i>SP 0mA (4mA/0V)</i>	The minimum value for the input signal is displayed.
-	-	Apply the minimum value to the input.
<b>OK</b>	Press 	Transfer and simultaneous return to the <i>calibr.SP</i> menu.
▲ / ▼	Select <i>SP 20mA (5V/10V)</i>	The maximum value for the input signal is displayed.
-	-	Apply the maximum value to the input.
<b>OK</b>	Press 	Transfer and simultaneous return to the <i>calibr.SP</i> menu.
<b>EXIT</b>	Press 	Acknowledgment and simultaneous return to the <i>CAL.USER</i> menu.
<i>calibr. PV</i> - calibration of the process actual value for input signal 4 - 20 mA:		
▲ / ▼	Select <i>calibr.PV</i>	
<b>ENTER</b>	Press 	The menu options for the minimum and the maximum process actual values are displayed.
▲ / ▼	Select <i>PV 4mA</i>	The minimum value for the input signal is displayed.
-	-	Apply the minimum value to the input.
<b>OK</b>	Press 	Transfer and simultaneous return to the <i>calibr.PV</i> menu.
▲ / ▼	Select <i>PV 20mA</i>	The maximum value for the input signal is displayed.
-	-	Apply the maximum value to the input.
<b>OK</b>	Press 	Transfer and simultaneous return to the <i>calibr.PV</i> menu.
<b>EXIT</b>	Press 	Acknowledgment and simultaneous return to the <i>CAL.USER</i> menu.
<i>calibr. PV</i> - calibration of the process actual value for input signal Pt 100:		
▲ / ▼	Select <i>calibr.PV</i>	
<b>ENTER</b>	Press 	The input screen for calibration of the temperature is opened.
▲ / ▼	<b>&lt;-</b> Select decimal place <b>+</b> Increase number	Input the current temperature.
<b>OK</b>	Press 	Transfer and simultaneous return to the <i>CAL.USER</i> menu.
<b>EXIT</b>	Press 	Acknowledgment and simultaneous return to the main menu (MAIN).


Key	Action	Description
EXIT	Press 	Switching from setting level $\Rightarrow$ process level.

Table 66: CAL.USER; calibration of position actual value and position set-point value

### 25.2.15.3. Resetting the settings under CAL.USER to the factory settings






Key	Action	Description
MENU	Press  for approx. 3 s	Switching from process level $\Rightarrow$ setting level.
▲ / ▼	Select CAL.USER	(To do this, the auxiliary function must be incorporated into the main menu).
ENTER		The submenu options are displayed.
▲ / ▼	Select copy FACT->USER	
RUN	 Hold down as long as countdown (5 ...) is running	The settings of CAL.USER are reset to the factory settings.
EXIT	Press 	Acknowledgment and simultaneous return to the main menu (MAIN).
EXIT	Press 	Switching from setting level $\Rightarrow$ process level.

Table 67: copy FACT->USER; resetting the settings under CAL.USER to the factory settings



The factory calibration is re-activated by deactivating CAL.USER, by removing the auxiliary function from the main menu (MAIN).

## 25.2.16 SET.FACTORY – Resetting to the factory settings

This function allows all settings implemented by the user to be reset to the delivery status.

All EEPROM parameters with the exception of the calibration values are reset to default values. Then a hardware reset is implemented.

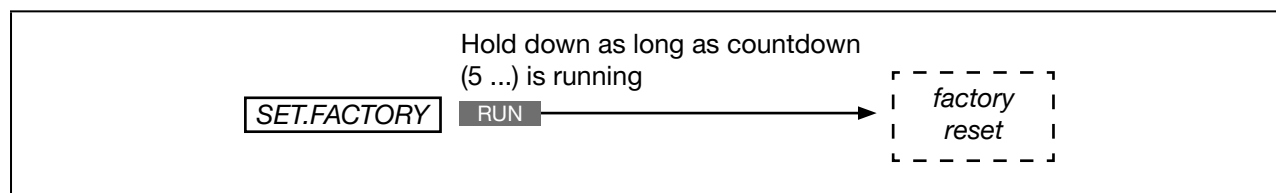


Fig. 77: Operating structure SET.FACTORY

### Resetting to the factory settings:




Key	Action	Description
<b>MENU</b>	Press  for approx. 3 s	Switching from process level $\Rightarrow$ setting level.
<b>▲ / ▼</b>	Select SET.FACTORY	(To do this, the auxiliary function must be incorporated into the main menu).
<b>RUN</b>	Press  for approx. 3 s (until progress bar is closed)	"factory reset" is shown. Reset is implemented.
<b>EXIT</b>	Press 	Switching from setting level $\Rightarrow$ process level.

Table 68: SET.FACTORY; Resetting to the factory settings



To adjust the Type 8792/8793 to the operating parameters, re-implement self-parameterization of the positioner (X.TUNE).

### 25.2.17 SER. I/O – Settings of the serial interface

This function can be used to set the type of the serial interface and the baud rate.

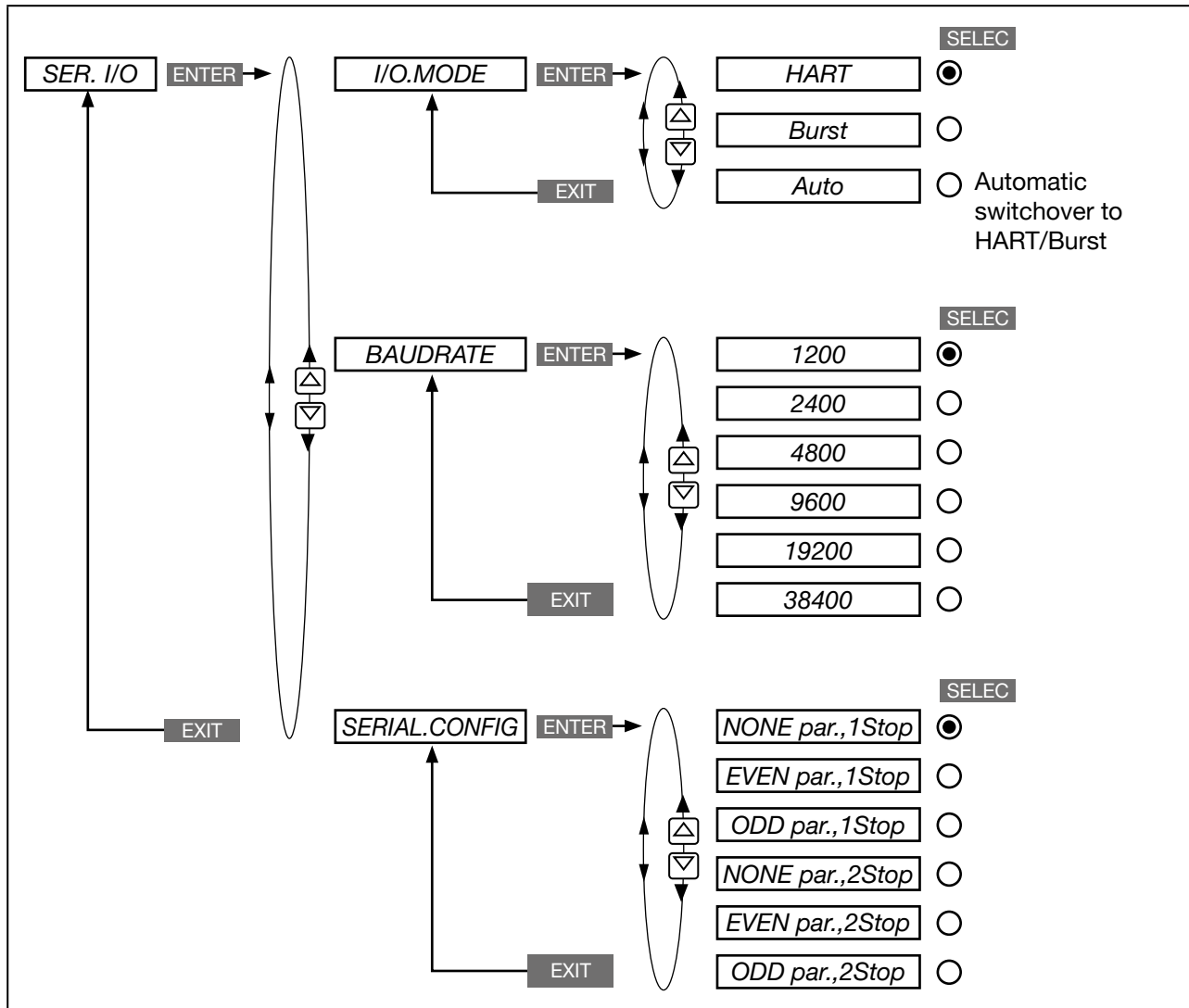


Fig. 78: Operating structure SER. I/O

### 25.2.18 EXTRAS – Setting the display

This function can be used to individually set the display.

- In *DISP.ITEMS* the display of the process level can be individually set. To do this, further menu options can be activated for the display of the process level. *POS* and *CMD* are activated in the as-delivered state.
- In *START-UP.ITEM* one of the activated menu options is specified as a start display after a restart.
- The type of display is selected via *DISP.MODE*.  
*normal* = black font on light background.  
*inverse* = white font on dark background.

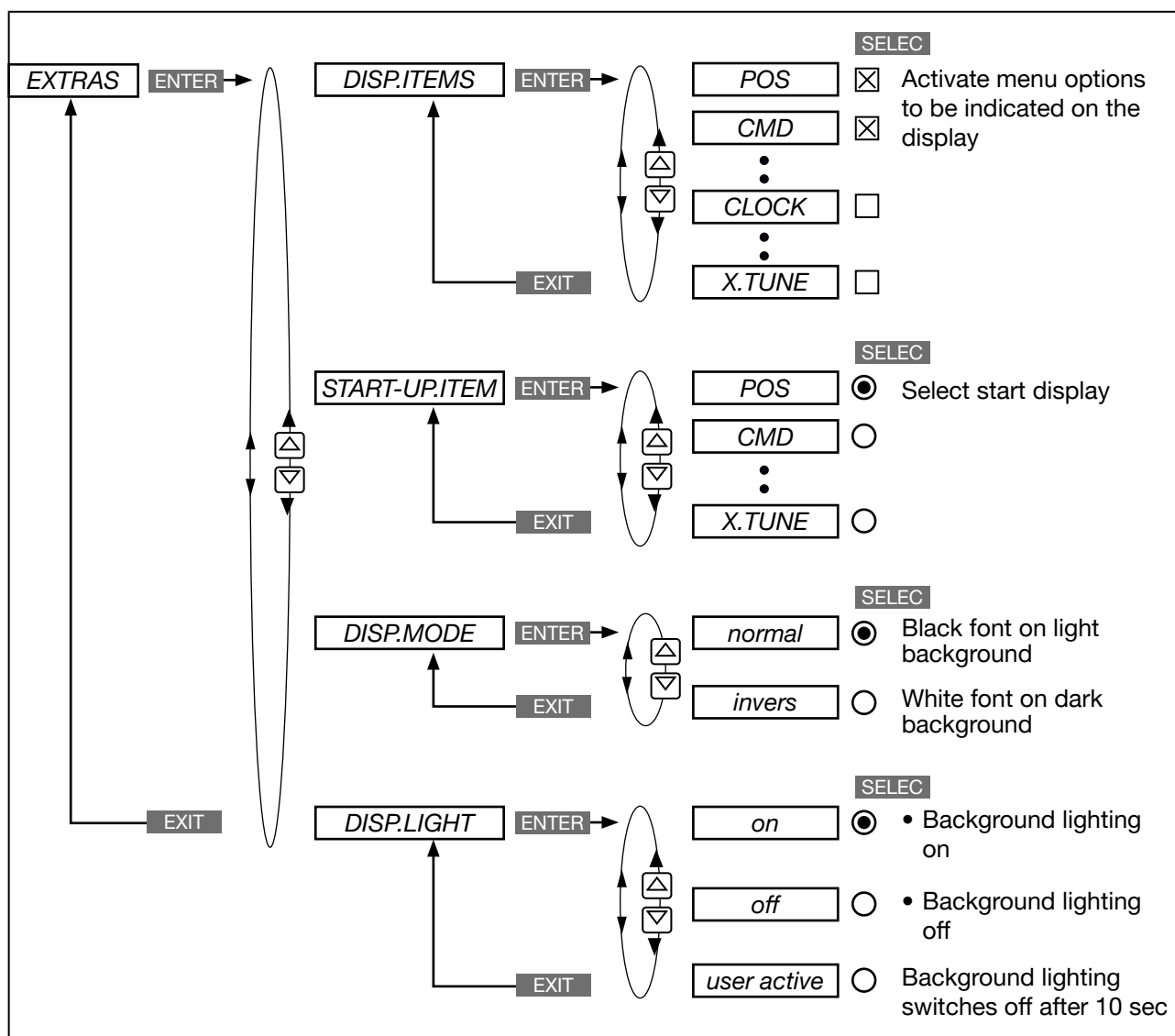


Fig. 79: Operating structure EXTRAS

MAN 1000118577 EN Version: K Status: RL (released | freigegeben) printed: 05.08.2022

**DISP.ITEMS - Activating menu displays for displaying the process level:**











Key	Action	Description
<b>MENU</b>	Press  for approx. 3 s	Switching from process level ⇔ setting level.
▲ / ▼	Select <b>ADD.FUNCTION</b>	
<b>ENTER</b>	Press 	The possible auxiliary functions are displayed.
▲ / ▼	Select <b>EXTRAS</b>	
<b>ENTER</b>	Press 	Activate the <b>EXTRAS</b> auxiliary function by checking the box <input checked="" type="checkbox"/> and transfer into the main menu.
<b>EXIT</b>	Press 	Return to the main menu (MAIN).
▲ / ▼	Select <b>EXTRAS</b>	
<b>ENTER</b>	Press 	The submenus of <b>EXTRAS</b> are displayed.
▲ / ▼	Select <b>DISP.ITEMS</b>	
<b>ENTER</b>	Press 	The possible menu options are displayed. <i>POS, CMD, CMDIPOS, CMD/POS(t), CLOCK, INPUT, TEMP, X.TUNE.</i>  <i>Additionally for process controller Type 8793: PV, SP, SPIPV, SP/PV(t), P.TUNE, P.LIN.</i>
▲ / ▼	Select required menu options	
<b>SELEC</b>	Press 	Activate the selection by checking the box <input checked="" type="checkbox"/> or deactivate it by unchecking the box <input type="checkbox"/> .
<b>EXIT</b>	Press 	Return to the <b>EXTRAS</b> menu.
<b>EXIT</b>	Press 	Return to the main menu (MAIN).
<b>EXIT</b>	Press 	Switching from setting level ⇔ process level.

Table 69: *DISP.ITEMS*; activating menu options to be displayed on the process level

The activated menu options are now displayed on the process level display.

Use the arrow keys ▲ ▼ to switch between the displays.



Each menu option which can be selected can also be deactivated so that it is not indicated on the process level display. However, there must be at least one menu option available which can be indicated on the display. If nothing was selected, the *POS* menu option is automatically activated.

**START-UP.ITEM - Specifying menu option for the start display:**

**EXTRAS** → **START-UP.ITEM** ▲ / ▼ Select menu option and specify with **SELEC**.

The menu option for the start display is marked by the filled circle ●.

The detailed procedure can be found in the extensive menu description for *DISP.ITEMS* (see “Table 69”). The *START-UP.ITEM* and *DISP.ITEMS* menus are set in the same way.

**DISP.MODE** - Select type of display

(black font on light background or white font on dark background):











Key	Action	Description
<b>MENU</b>	Press  for approx. 3 s	Switching from process level ⇔ setting level.
▲ / ▼	Select <b>ADD.FUNCTION</b>	
<b>ENTER</b>	Press 	The possible auxiliary functions are displayed.
▲ / ▼	Select <b>EXTRAS</b>	
<b>ENTER</b>	Press 	Activate the <b>EXTRAS</b> auxiliary function by checking the box <input checked="" type="checkbox"/> and transfer into the main menu.
<b>EXIT</b>	Press 	Return to the main menu (MAIN).
▲ / ▼	Select <b>EXTRAS</b>	
<b>ENTER</b>	Press 	The submenus of <b>EXTRAS</b> are displayed.
▲ / ▼	Select <b>DISP.MODE</b>	
<b>ENTER</b>	Press 	The possible menu options for the type of display are shown. <i>normal</i> = black font on light background <i>inverse</i> = white font on dark background
▲ / ▼	Select the type of display	
<b>SELEC</b>	Press 	The selection is marked by a filled circle ●.
<b>EXIT</b>	Press 	Return to the <b>EXTRAS</b> menu.
<b>EXIT</b>	Press 	Return to the main menu (MAIN).
<b>EXIT</b>	Press 	Switching from setting level ⇔ process level.

Table 70: **DISP.MODE**; Select type of display**DISP.LIGHT** - Define background lighting for display:

**EXTRAS** → **DISP.LIGHT** ▲ / ▼ Select background lighting and define with **SELEC** .

The menu option for the background lighting is marked by the filled circle ●.

- *on* = Background lighting on.
- *off* = Background lighting off.
- *user active* = Background lighting switches off after 10 seconds with no user interaction. If a key is pressed again, the background lighting goes on again.

The detailed procedure can be found in the extensive menu description for **DISP.MODE** (see “Table 70”). The **DISP.LIGHT** and **DISP.MODE** menus are set in the same way.

### 25.2.19 POS.SENSOR – Setting interface remote position sensor

The interface for the connection of an external position sensor can be selected in this menu.

The POS.SENSOR menu option is available for Type 8793 Remote only.

The following connection options are possible:

Interface	Position sensor	Setting in the menu (ADD.FUNCTION)
digital (serial)	Remote sensor Type 8798.	POS.SENSOR → DIGITAL
analog (4 - 20 mA) *	Any, high-resolution position sensor.	POS.SENSOR → ANALOG

Table 71: Connection options type 8793 with external position sensor

**!** \* If the position sensor is connected to the process controller type 8793 via the analog interface, it can be operated only as a positioner.  
The P.CONTROL auxiliary function is automatically removed.

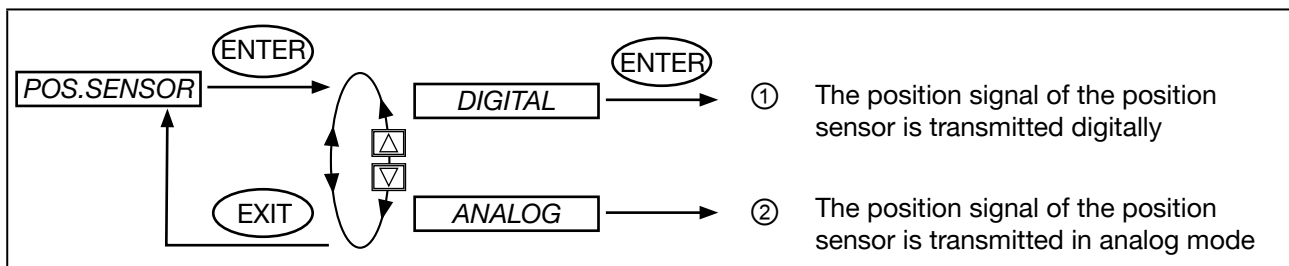


Fig. 80: Operating structure POS.SENSOR

- ① Digital interface (menu option POS.SENSOR → DIGITAL):  
Type 8792/8793 is connected to the position sensor Type 8798 via a digital interface (see Chapter “15.2.4 Terminal assignment for external position sensor (for remote model only)” ).
- ② Analog interface (menu option POS.SENSOR → ANALOG):  
Type 8793 is connected via a 4...20 mA interface to any position sensor with 4...20 mA output signal. To do this, the position sensor is connected to the process actual value input (see Chapter “15.3.1 Terminal assignments of the process actual value input”).

If the position sensor requires an additional power supply of 24 V DC, it can be supplied via the positioner.

### 25.2.20 SERVICE

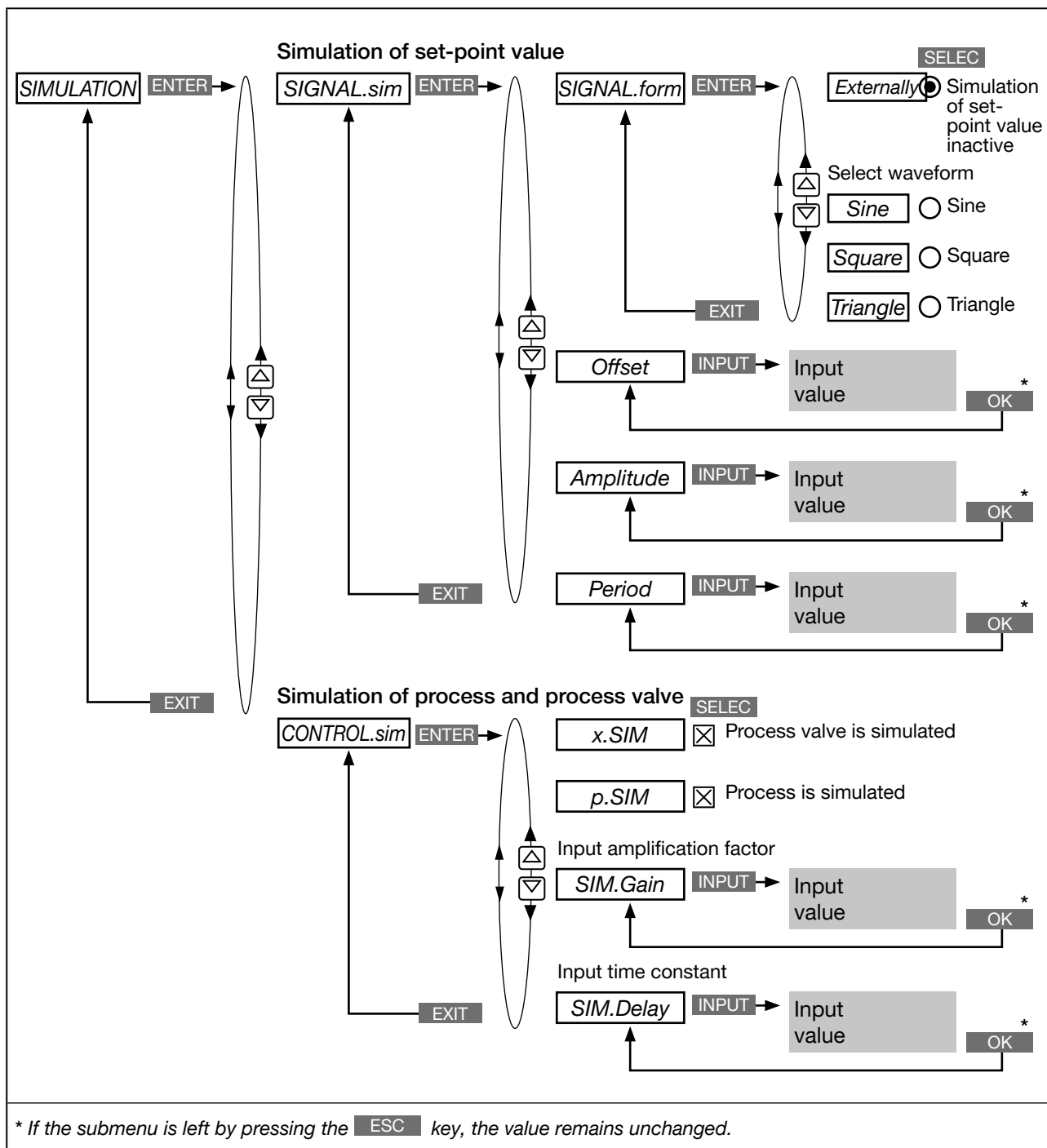
This function is of no importance to the operator of Type 8792/8793. It is for internal use only.



### 25.2.21 SIMULATION – Menu for simulation of set-point value, process and process valve

This function can be used to simulate set-point value, process and process valve independently of each other.

**Caution!** Restarting the device deactivates the simulation. The settings of *SIGNAL.form*, *x.SIM* and *p.SIM* are reset to the factory setting.




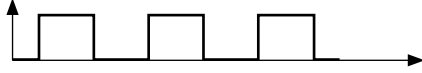

MAN 1000118577 EN Version: K Status: RL (released | freigegeben) printed: 05.08.2022

Fig. 81: Operating structure SIMULATION

**25.2.21.1. SIGNAL.sim – Simulation of the set-point value**

The settings to simulate the set-point value are made in the *SIGNAL.sim* menu.

**Activation of the simulation:** In the *SIGNAL.form* submenu by selecting one of the following waveforms

<i>Sine</i>	Sine wave	
<i>Square</i>	Square wave	
<i>Triangle</i>	Triangle wave	
<i>Mixed</i>	Single cycle of an alternating signal sequence. Then the selection is set to <i>External</i> (set-point value simulation inactive).	

The following parameters can be set for the selected waveform.

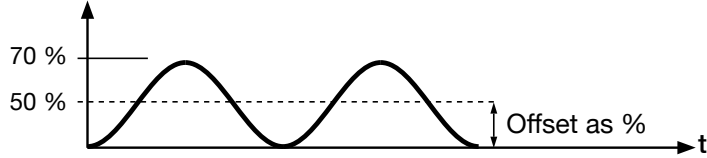
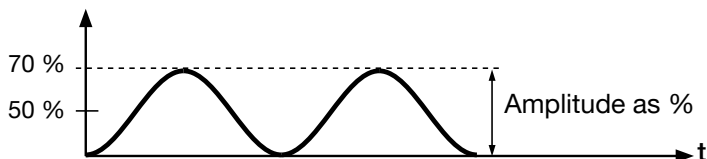
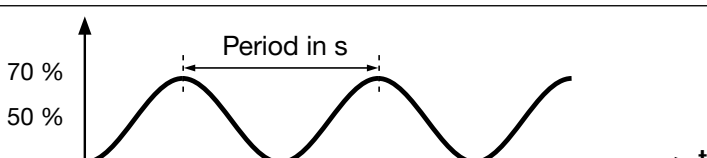

Menu option	Parameter setting	Schematic representation with sine wave
<i>Offset</i>	(Zero offset as %)	
<i>Amplitude</i>	(Amplitude as %)	
<i>Periode</i>	(Cycle duration in s)	

Table 72: *SIGNAL.sim*; parameter settings for set-point value simulation

**Deactivation of the simulation:** In the *SIGNAL.form* submenu

Selection *Externally* = set-point value simulation inactive  
(corresponds to the factory setting in the as-delivered state)

**Activating and parameterizing the set-point value simulation:**

Key	Action	Description
MENU	Press  for approx. 3 s	Switching from process level ⇌ setting level.
▲ / ▼	Select <i>SIMULATION</i>	(To do this, the auxiliary function must be incorporated into the main menu).















Key	Action	Description
ENTER	Press 	The submenu for setting the simulation is displayed.
▲ / ▼	Select <i>SIGNAL.sim</i>	
ENTER	Press 	The submenu for activating and parameterizing the set-point value simulation is displayed.
▲ / ▼	Select <i>SIGNAL.form</i>	
ENTER	Press 	The menu options for activating and for selecting the waveform are displayed.
▲ / ▼	Select required menu option	Selection <input type="checkbox"/> <i>Externally</i> = simulation inactive. Selection <input type="checkbox"/> <i>Sine</i> / <input type="checkbox"/> <i>Square</i> / <input type="checkbox"/> <i>Triangle</i> / <input type="checkbox"/> <i>Mixed</i> = specify the waveform as well as activation of the simulation.
SELEC	Press 	The selection is marked by a filled circle <input checked="" type="radio"/> .
EXIT	Press 	Return to the <i>SIGNAL.sim</i> menu.
Setting the parameters for simulation of the set-point value:		
▲ / ▼	Select <i>Offset</i>	(Zero offset as %).
INPUT	Press 	The input screen for specifying the offset is opened.
▲ / ▼	<input type="button" value="+"/> Increase value <input type="button" value="&lt;-"/> Select decimal place	Input value.
OK	Press 	Transfer and simultaneous return to the <i>SIGNAL.sim</i> menu.
▲ / ▼	Select <i>Amplitude</i>	(Amplitude as %).
INPUT	Press 	The input screen for specifying the amplitude is opened.
▲ / ▼	<input type="button" value="+"/> Increase value <input type="button" value="&lt;-"/> Select decimal place	Input value.
OK	Press 	Transfer and simultaneous return to the <i>SIGNAL.sim</i> menu.
▲ / ▼	Select <i>Period</i>	(Cycle duration in seconds).
INPUT	Press 	The input screen for specifying the cycle duration is opened.
▲ / ▼	<input type="button" value="+"/> Increase value <input type="button" value="&lt;-"/> Select decimal place	Input value.
OK	Press 	Transfer and simultaneous return to the <i>SIGNAL.sim</i> menu.
EXIT	Press 	Return to the <i>SIMULATION</i> menu.
For simulation of process and process valve:		
▲ / ▼	Select <i>CONTROL.sim</i>	For description see Chapter " <a href="#">26.2.21.2. CONTROL.sim – Simulation of the process and process valve</a> ".
Leaving the <i>SIMULATION</i> menu:		
EXIT	Press 	Return to the main menu (MAIN).
EXIT	Press 	Switching from setting level $\Rightarrow$ process level.

Table 73: *SIGNAL.sim*; activating and parameterizing the set-point value simulation.

### 25.2.21.2. CONTROL.sim – Simulation of the process and process valve

The settings to simulate the process and the process valve are made in the *CONTROL.sim* menu.

#### Settings

Type of simulation:  *x.SIM* Simulation of the process valve.

*p.SIM* Simulation of the process.

Parameterization of the process:  *SIM.Gain* Specify amplification factor.

*SIM.Delay* Specify time constant in seconds.

#### Example of a simulated process:

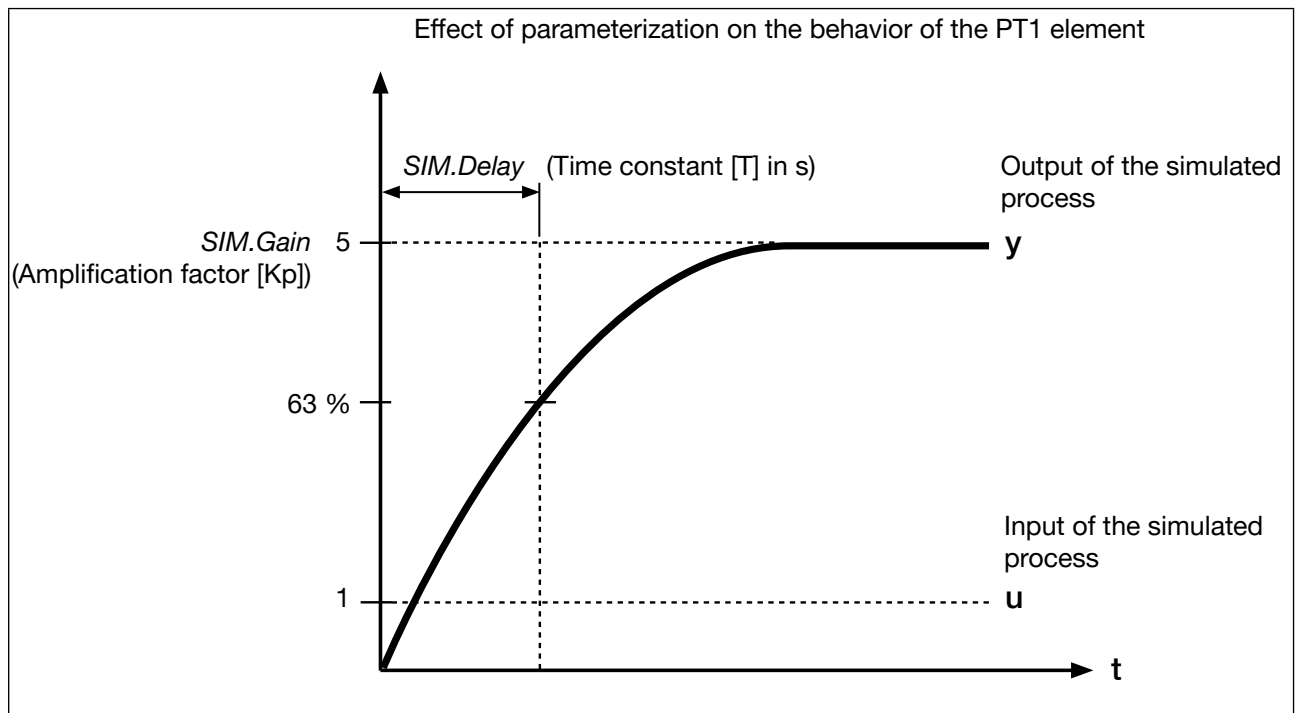





Fig. 82: Example of a simulated process. Behavior of the PT1 element

#### Activating and parameterizing simulation of the process and/or process valve:

Key	Action	Description
<b>MENU</b>	Press  for approx. 3 s	Switching from process level $\Rightarrow$ setting level.
<b>▲ / ▼</b>	Select <i>SIMULATION</i>	(To do this, the auxiliary function must be incorporated into the main menu).
<b>ENTER</b>	Press 	The submenu for setting the simulation is displayed.
<b>▲ / ▼</b>	Select <i>CONTROL.sim</i>	
<b>ENTER</b>	Press 	The submenu for activating and parameterizing the process and process valve simulation is displayed.









Key	Action	Description
▲ / ▼	Select required simulation	Selection <input type="checkbox"/> <i>x.SIM</i> = simulation process. Selection <input type="checkbox"/> <i>p.SIM</i> = simulation process valve.
<b>SELEC</b>	Press 	Activate the selection by checking the box <input checked="" type="checkbox"/> or deactivate it by unchecking the box <input type="checkbox"/> .
Setting the parameters for simulation of the process and/or the process valve:		
▲ / ▼	Select <i>SIM.Gain</i>	(Amplification factor).
<b>INPUT</b>	Press 	The input screen for specifying the amplification factor is opened.
▲ / ▼	<b>+</b> Increase value <b>&lt;-</b> Select decimal place	Input value.
<b>OK</b>	Press 	Transfer and simultaneous return to the <i>CONTROL.sim</i> menu.
▲ / ▼	Select <i>SIM.Delay</i>	(Time constant in seconds).
<b>INPUT</b>	Press 	The input screen for specifying the time constant is opened.
▲ / ▼	<b>+</b> Increase value <b>&lt;-</b> Select decimal place	Input value.
<b>OK</b>	Press 	Transfer and simultaneous return to the <i>CONTROL.sim</i> menu.
<b>EXIT</b>	Press 	Return to the <i>SIMULATION</i> menu.
<b>EXIT</b>	Press 	Return to the main menu (MAIN).
<b>EXIT</b>	Press 	Switching from setting level $\Rightarrow$ process level.

Table 74: *CONTROL.sim*; aktivieren und parametrieren der Simulation des Prozesses und/oder Prozessventils.

### 25.2.22 DIAGNOSE – Menu for monitoring valves (option)

The optional function *DIAGNOSE* can be used to monitor the state of the valve. If there are deviations from the set-point state, messages are output according to NE 107.

Example of the output of a diagnosis message:

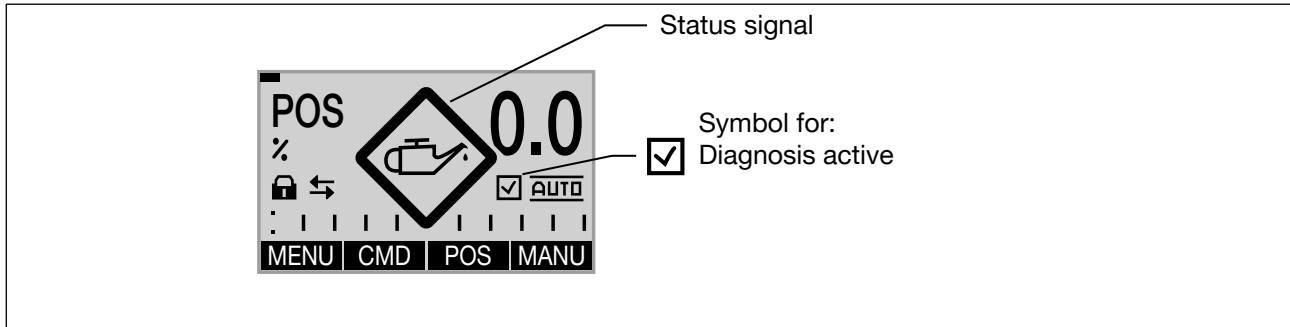


Fig. 83: Example of a diagnosis message

#### 25.2.22.1. Activation of the *DIAGNOSE* menu

To ensure that the *DIAGNOSE* menu can be set, it must first be activated in the main menu of the setting level (MAIN) via *ADD.FUNCTION*. See Chapter “26.1 Activating and deactivating auxiliary functions”.



The active diagnosis is indicated on the display of the process level with a check mark symbol . See “Fig. 83”.

#### 25.2.22.2. The *DIAGNOSE* main menu

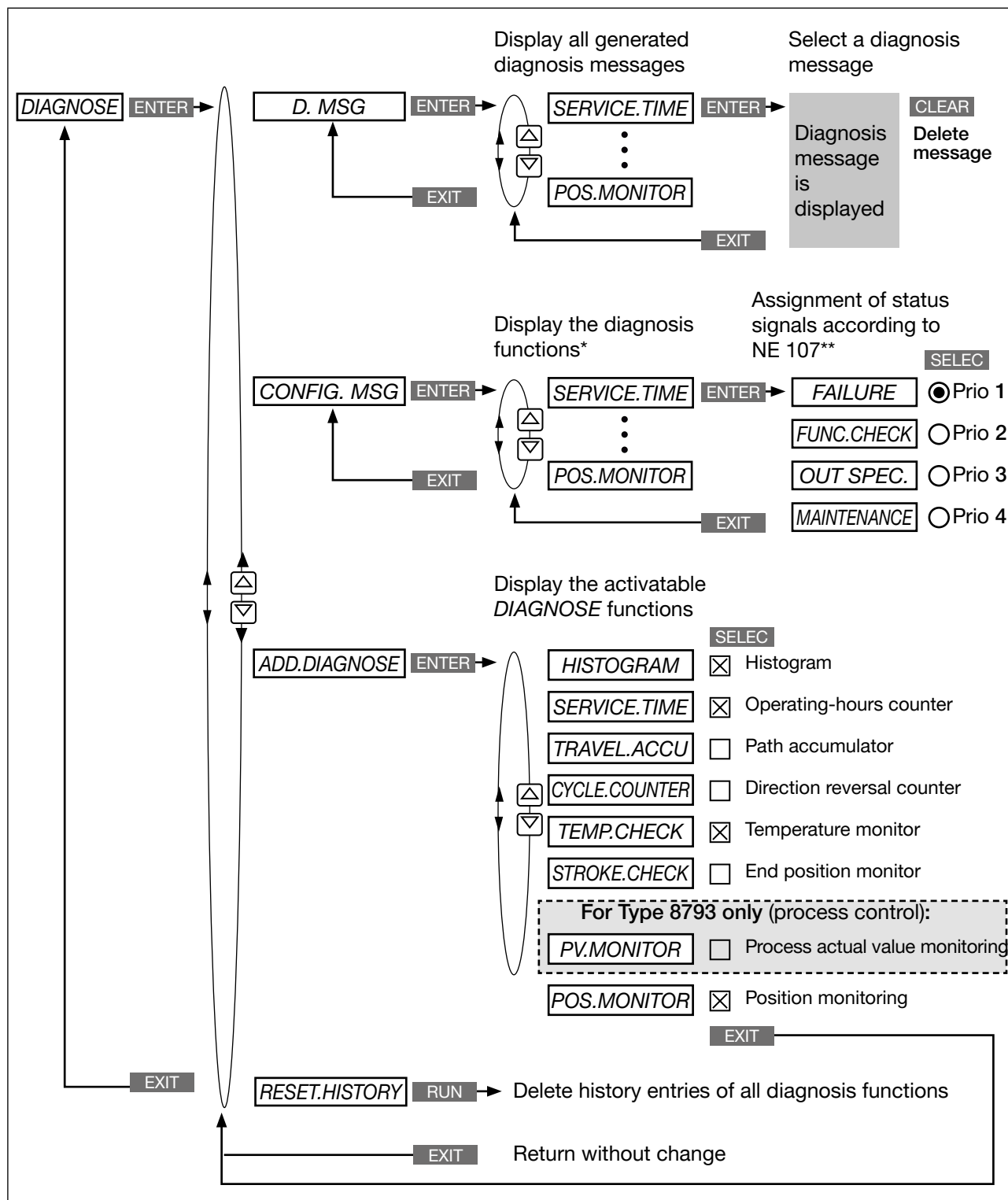
The *DIAGNOSE* main menu consists of the following submenus.

	<b>D.MSG</b>	(Diagnosis messages) list of all diagnosis messages.
	<b>CONFIG.MSG</b>	Assignment of status signals for different diagnosis messages according to NE 107 (NE = NAMUR recommendation).
	<b>ADD.DIAGNOSE</b>	Activation of diagnosis functions by incorporation into the <i>DIAGNOSE</i> main menu.
	<b>RESET.HISTORY</b>	Deletion of the history entries of all diagnosis functions. The menu is only displayed if the <i>CLOCK</i> function has been selected on the process level.

Table 75: *DIAGNOSE*; main menu

The description can be found in Chapter “26.2.22.5. Description of the *DIAGNOSE* main menu”.

25.2.22.3. DIAGNOSE – Operating structure



\* Only the diagnosis functions are displayed which have been activated in the ADD.DIAGNOSE menu.  
 \*\* If several diagnosis messages are available simultaneously, the status signal with the highest priority is shown on the display.

MAN 1000118577 EN Version: K Status: RL (released | freigegeben) printed: 05.08.2022

Fig. 84: Operating structure DIAGNOSE

### 25.2.22.4. Activation of diagnosis functions

In the *ADD.DIAGNOSE* menu several diagnosis functions are activated and incorporated into the *DIAGNOSE* main menu.

Activatable diagnosis functions:

<b>HISTOGRAM</b>	Graphical display of the dwell time density and movement range.
<b>SERVICE.TIME</b>	Operating-hours counter
<b>TRAVEL.ACCU</b>	Path accumulator
<b>CYCLE.COUNTER</b>	Direction reversal counter
<b>TEMP.CHECK</b>	Temperature monitor
<b>STROKE.CHECK</b>	Monitoring of the mechanical end positions in the armature
<b>PV.MONITOR</b>	Process actual value monitoring (only for Type 8793, process control)
<b>POS.MONITOR</b>	Position monitoring

Table 76: *ADD.DIAGNOSE*; overview of diagnosis functions

The exact description can be found in Chapter “26.2.22.6. Description of the diagnosis functions”

#### **ADD.DIAGNOSE** - Activating diagnosis functions:







Key	Action	Description
<b>MENU</b>	Press  for approx. 3 s	Switching from process level ⇔ setting level.
▲ / ▼	Select <i>DIAGNOSE</i>	(To do this, the <i>DIAGNOSE</i> auxiliary function must already have been activated by incorporation into the main menu (MAIN)).
<b>ENTER</b>	Press 	The submenus are displayed.
▲ / ▼	Select <i>ADD.DIAGNOSE</i>	
<b>ENTER</b>	Press 	The other diagnosis functions are displayed.
▲ / ▼	Select required diagnosis function	
<b>ENTER</b>	Press 	The required diagnosis function is now marked by a cross ☒.
either		
▲ / ▼	Select further diagnosis functions	Keep repeating until all required diagnosis functions have been marked with a cross ☒.
<b>ENTER</b>	Press 	
or		
<b>EXIT</b>	Press 	Acknowledgment and simultaneous return to the <i>DIAGNOSE</i> main menu. The marked diagnosis functions have been activated and the setting menus are now in the <i>DIAGNOSE</i> main menu.

Table 77: *Activation of diagnosis functions*

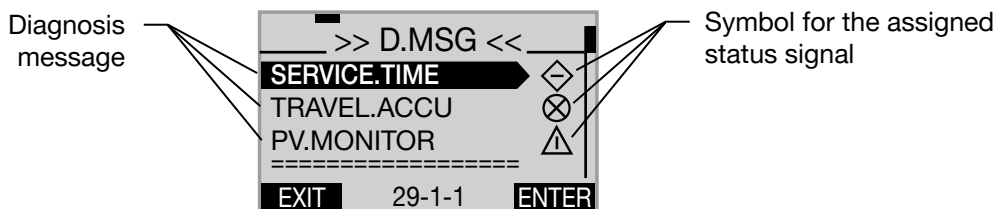


### 25.2.22.5. Description of the *DIAGNOSE* main menu

#### 1. D.MSG – Diagnosis messages

All generated diagnosis messages are listed in the D.MSG menu where they can be viewed and deleted. The status signal, which is assigned to the diagnosis message, is indicated by a symbol.

Display example of a list with diagnosis messages



Display example of the description text of a diagnosis message



Viewing and deleting a diagnosis message:

Key	Action	Description
▲ / ▼	Select <i>D.MSG</i>	
<span style="border: 1px solid black; padding: 2px;">ENTER</span>	Press	All generated diagnosis messages are displayed.
▲ / ▼	Select required message	
<span style="border: 1px solid black; padding: 2px;">ENTER</span>	Press	Opening the diagnosis message. The description text is displayed (in English).
<span style="border: 1px solid black; padding: 2px;">EXIT</span> or <span style="border: 1px solid black; padding: 2px;">CLEAR</span>	Press  Hold down as long as countdown (5 ...) is running	Closing the diagnosis message and return to <i>D.MSG</i> .  Deleting the diagnosis message and return to <i>D.MSG</i> .
<span style="border: 1px solid black; padding: 2px;">EXIT</span>	Press	Return to the <i>DIAGNOSE</i> main menu.

Table 78: *D.MSG*; viewing and deleting a diagnosis message

#### 2. CONFIG.MSG – Assignment of status signals according to NE 107 (NAMUR recommendation)

The status signals of the diagnosis messages can be changed in the CONFIG.MSG menu.



The menu indicates only diagnosis functions which can output a message and which have already been activated in the *ADD.DIAGNOSE* menu.

The status signals have different priorities.

If several diagnosis messages are available with different status signals, the status signal with the highest priority is shown on the display.

Overview of the status signals according to NE 107 (NE = NAMUR recommendation):





Priority	1	2	3	4
Status signal				
Description	Failure	Function check	Out of specification	Maintenance required

Table 79: CONFIG.MSG; overview of status signals

The following status signals have been preset at the factory for the messages of the diagnosis functions:








Diagnosis function	Status signal according to NE 107	Signal Miniature	Priority
SERVICE.TIME	Maintenance required		4
TRAVEL.ACCU	Maintenance required		4
CYCLE.COUNTER	Maintenance required		4
TEMP.CHECK	Out of specification		3
STROKE.CHECK	Out of specification		3
PV.MONITOR	Out of specification		3
POS.MONITOR	Out of specification		3

Table 80: CONFIG.MSG; factory setting (Default)

Assignment of status signals:






Key	Action	Description
▲ / ▼	Select CONFIG.MSG	
ENTER	Press 	All activated diagnosis functions, which can output a message, are displayed.
▲ / ▼	Select required diagnosis function	
ENTER	Press 	The list of possible status signals is displayed.
▲ / ▼	Select required status signal	
SELEC	Press 	The selected status signal is now marked by a filled circle ●.
EXIT	Press 	Acknowledgment and simultaneous return to the CONFIG.MSG menu. The status signal is now assigned to the diagnosis function.
EXIT	Press 	Return to the DIAGNOSE main menu.

Table 81: CONFIG.MSG; assignment of status signals


### 3. **ADD.DIAGNOSE** – Activation and deactivation of diagnosis functions

Diagnosis functions can be activated in this menu and incorporated into the *DIAGNOSE* main menu or already activated diagnosis functions can be deactivated again.

#### Activation of diagnosis functions:

For description see Chapter [“26.2.22.4. Activation of diagnosis functions”](#)

#### Deactivation of diagnosis functions:

The procedure is the same as for activation. Except that with deactivation the cross after the diagnosis function is removed again by pressing the **ENTER** key .

### 4. **RESET.HISTORY** – Deletion of the history entries of all diagnosis functions

Explanation of the history entries:

There is a history entry for each diagnosis message. This entry is assigned to the diagnosis function, which has actuated this message, and is saved there in the *HISTORY* submenu.



In the menu of some diagnosis functions there is a *HISTORY* submenu in which the history entries are saved.

*RESET.HISTORY* is used to delete the entries of all *HISTORY* submenus.

Individual entries can be deleted in the *HISTORY* submenu of the particular diagnosis function.

See also chapter [“26.2.22.7. History entries in the \*HISTORY\* submenu”](#).

#### Deleting all history entries:




Key	Action	Description
	Select <i>RESET.HISTORY</i>	
<b>RUN</b>	 Hold down as long as countdown (5 ...) is running	All history entries are deleted.
<b>EXIT</b>	Press 	Return to the <i>DIAGNOSE</i> main menu.

Table 82: *RESET.HISTORY*; deleting all history entries

#### CAUTION!



History entries are only created when the *CLOCK* function for the display has been activated on the process level.

For activation and setting of *CLOCK* see Chapter [“17.4.1 Setting date and time:”](#)

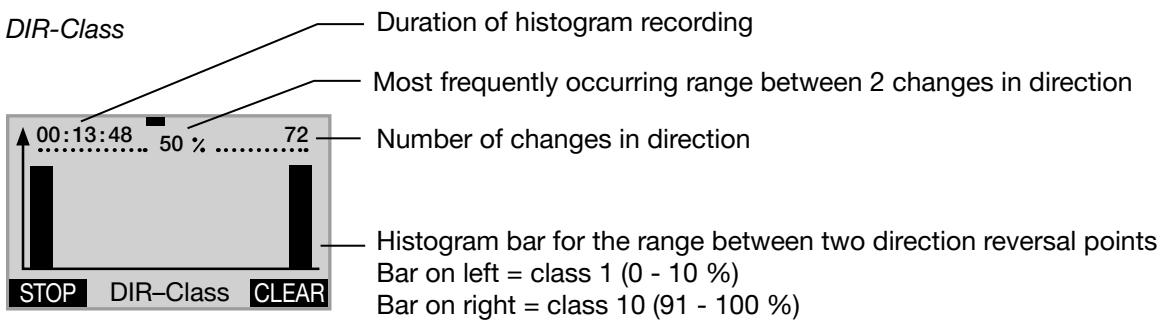
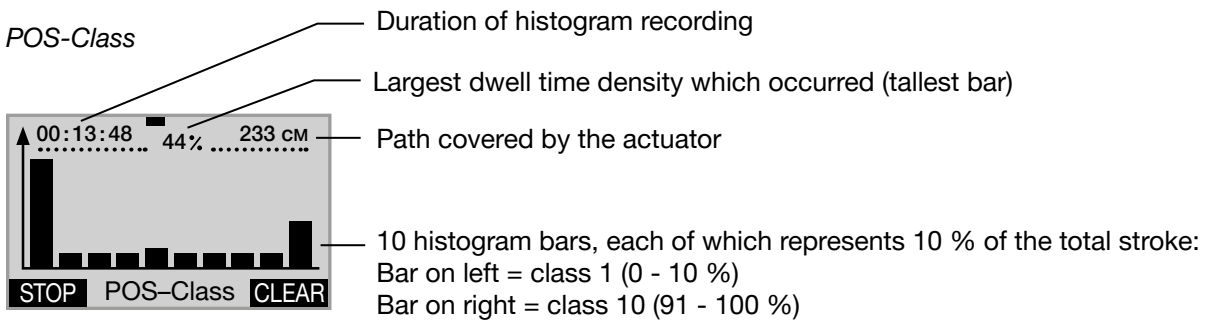
### 25.2.22.6. Description of the diagnosis functions

#### **HISTOGRAM** – Output of histograms

The *HISTOGRAM* menu is divided into 2 parts:

1. **Outputting the histograms for**  
*POS class* (dwell time density) and  
*DIR class* (movement range)
2. **List of the characteristic values for**  
 CMD Set-point position valve actuator  
 POS Actual position valve actuator  
 DEV Deviation from POS to CMD  
 TEMP Temperature  
 SP Process set-point value  
 PV Process actual value

Display description of the histograms:



Operating structure:

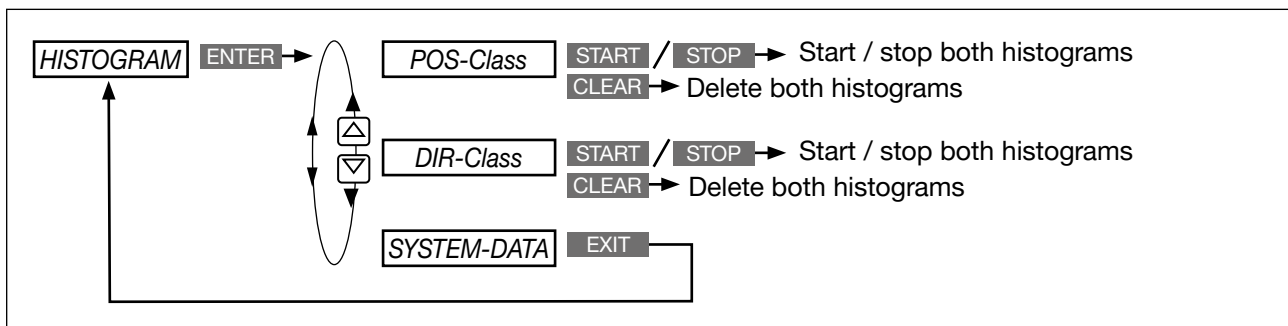


Fig. 85: *HISTOGRAM*; operating structure

**POS-Class - Description of the histogram of the dwell time density**

The histogram indicates how long the actuator has stopped in a specific position.

For this purpose the stroke range is divided into 10 classes.

The current position of one of the 10 classes is assigned to each scan time.

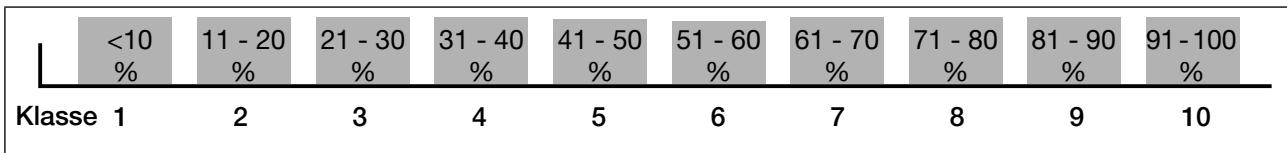


Fig. 86: CMD class; position classes

**Explanation of the histogram in the example**

Sinusoidal progression of the actuator position:

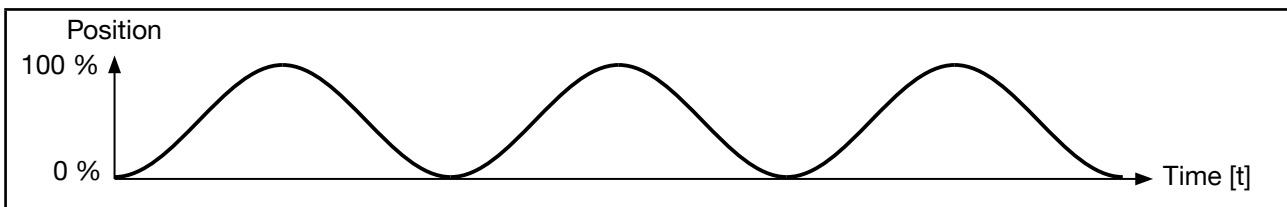


Fig. 87: Sinusoidal progression of the actuator position

Histogram of the sinusoidal progression of the actuator position:

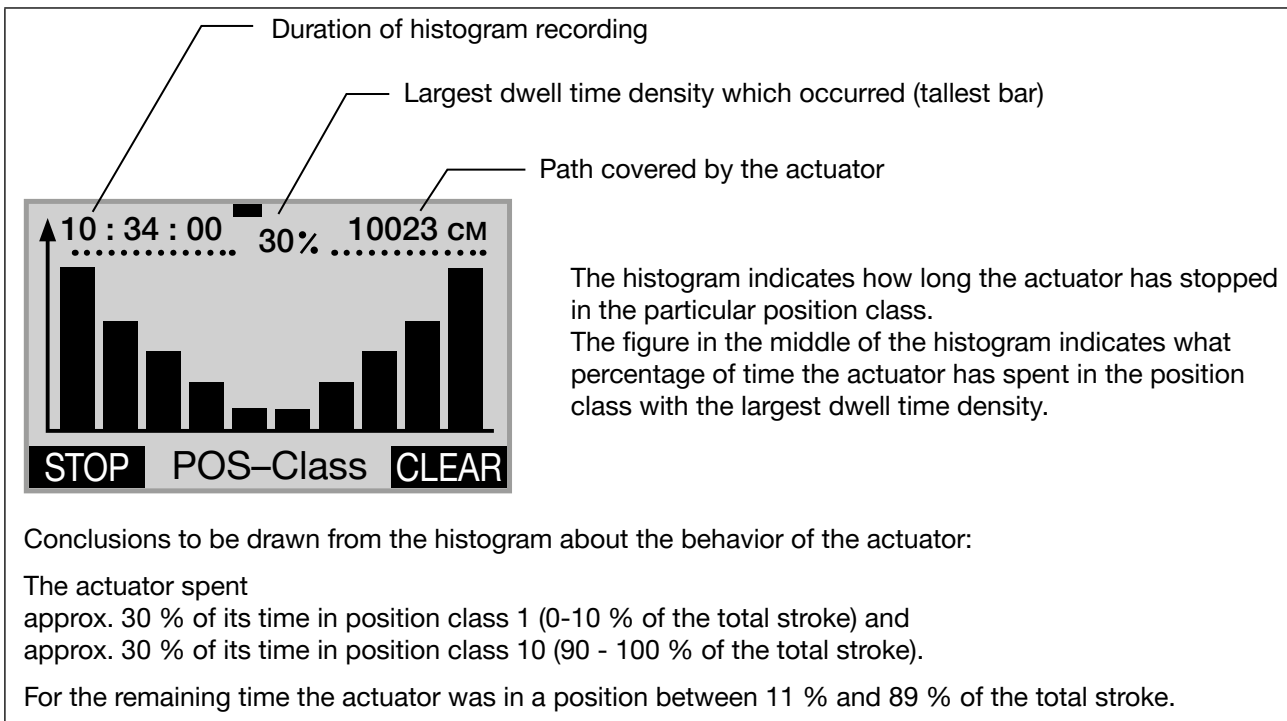


Fig. 88: POS class; histogram of the dwell time density for sinusoidal progression of the actuator position



The distribution of the histogram allows conclusions to be drawn about the design of the control valve. For example, if the actuator is in the lower stroke range only, the valve has probably been designed too large.

MAN 1000118577 EN Version: K Status: RL (released | freigegeben) printed: 05.08.2022

**DIR-Class - Description of the histogram of the movement range**

The histogram indicates the movement ranges of the actuator between two direction reversal points.

For this purpose the movement range between two changes in direction is divided into 10 classes.

The current position of one of the 10 classes is assigned to each scan time.

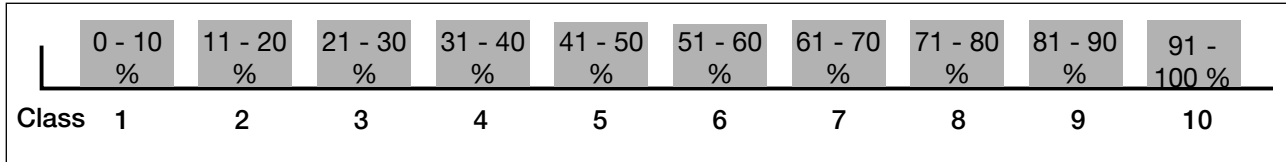


Fig. 89: DIR class; change in direction classes

**Explanation of the histogram in the example**

Sinusoidal progression of the actuator position:

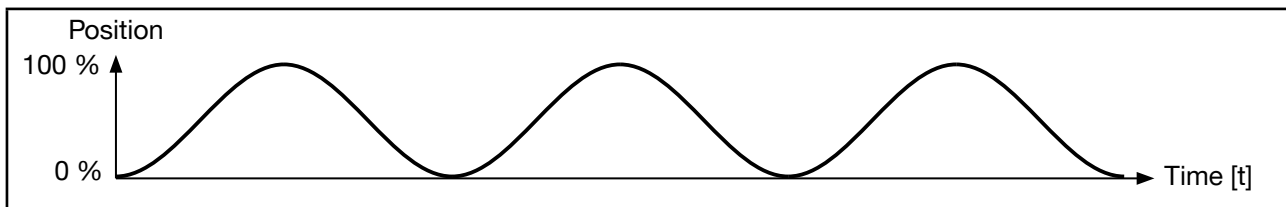


Fig. 90: Sinusoidal progression of the actuator position

Histogram of the sinusoidal progression of the actuator position:

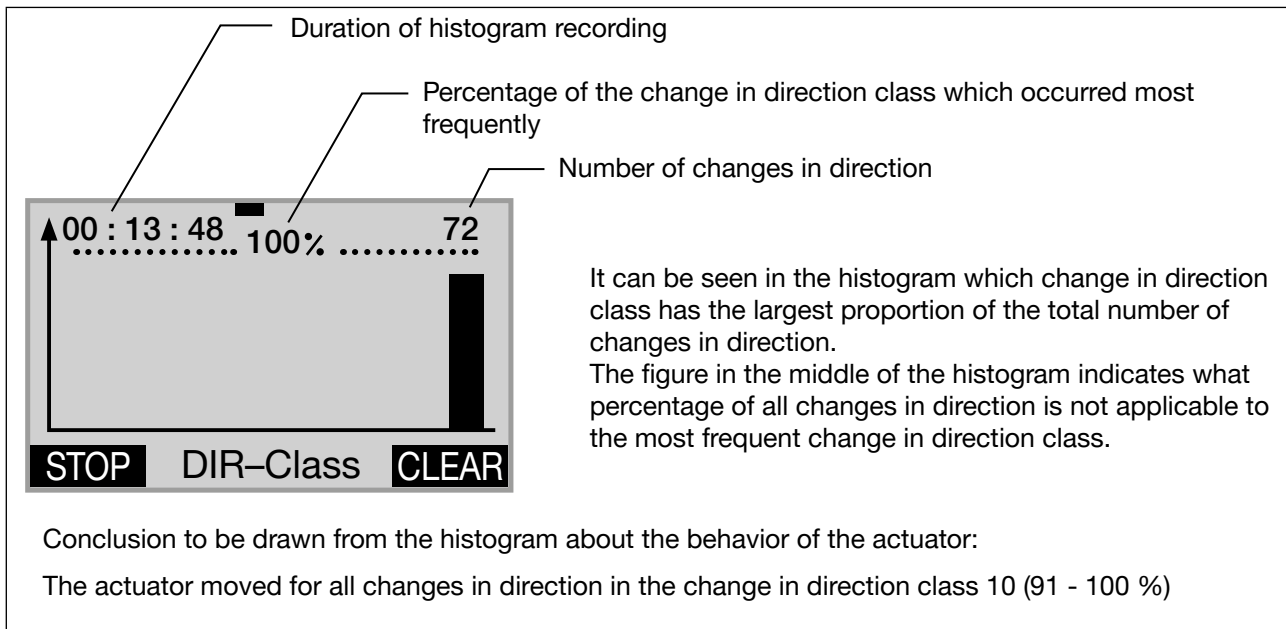


Fig. 91: DIR class; histogram of the dwell time density for sinusoidal progression of the actuator position



The histograms will only give correct information about the behavior of the actuator when the X.TUNE function required for the basic setting has been run.

MAN 1000118577 EN Version: K Status: RL (released | freigegeben) printed: 05.08.2022

## Starting, stopping and deleting the histograms







Key	Action	Description
▲ / ▼	Select <i>HISTOGRAM</i>	(To do this, the <i>HISTOGRAM</i> function must be incorporated into the <i>DIAGNOSE</i> main menu. See Chapter “26.2.22.4. Activation of diagnosis functions”).
ENTER	Press 	The empty matrix of the <i>POS-Class</i> submenu (dwell time density) is displayed.
<b>Starting histograms:</b>		
START *	 Hold down as long as countdown (5 ...) is running	Both histograms ( <i>POS class</i> and <i>DIR class</i> ) are started.
▲ / ▼	Changing the display view	Selection options: <i>POS class</i> (Histogram for the dwell time density), <i>DIR class</i> (Histogram for the movement range), <i>SYSTEM DATA</i> (list of the characteristic values).
<b>Stopping histograms:</b>		
STOP *	 Hold down as long as countdown (5 ...) is running	The recording of both histograms ( <i>POS class</i> and <i>DIR class</i> ) is stopped.
▲ / ▼	Changing the display view	Selection options: <i>POS class</i> (Histogram for the dwell time density), <i>DIR class</i> (Histogram for the movement range), <i>SYSTEM DATA</i> (list of the characteristic values).
<b>Deleting histograms:</b>		
CLEAR *	 Hold down as long as countdown (5 ...) is running	Both histograms ( <i>POS class</i> and <i>DIR class</i> ) are deleted.
<b>Return to the <i>DIAGNOSE</i> main menu:</b>		
▲ / ▼	Select <i>SYSTEM DATA</i>	
EXIT	Press  or 	Return to the <i>DIAGNOSE</i> main menu.
* The key functions <b>START</b> , <b>STOP</b> and <b>CLEAR</b> are available only in the display views of the histograms <i>POS class</i> and <i>DIR class</i> .		

Table 83: *HISTOGRAM*; starting, stopping and deleting histograms

**SERVICE.TIME** – Operating-hours counter

The operating-hours counter records the time during which the device was switched on.

If the duty cycle reaches the specified time limit, a message is generated.

- To do this, a history entry is made in the *HISTORY* submenu. For description see “26.2.22.7. History entries in the *HISTORY* submenu”.
- The status signal, which is assigned to the message, is indicated at short intervals on the display. See also *D.MSG* and *CONFIG.MSG* in Chapter “26.2.22.5”, page 147.

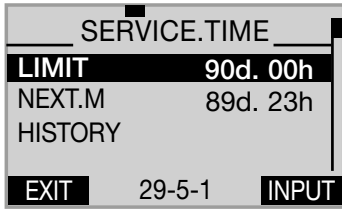
Display <i>SERVICE.TIME</i>	Description of the functions
	<p>The interval for messages preset at the factory for 90 days can be changed in the <i>LIMIT</i> submenu.</p> <p>After <i>NEXT.M</i> the remaining time is displayed until the next message appears.</p> <p>The history entries of the last 3 messages can be viewed and deleted in the <i>HISTORY</i> submenu.</p>

Table 84: *SERVICE.TIME*; operating-hours counter

Operating structure:

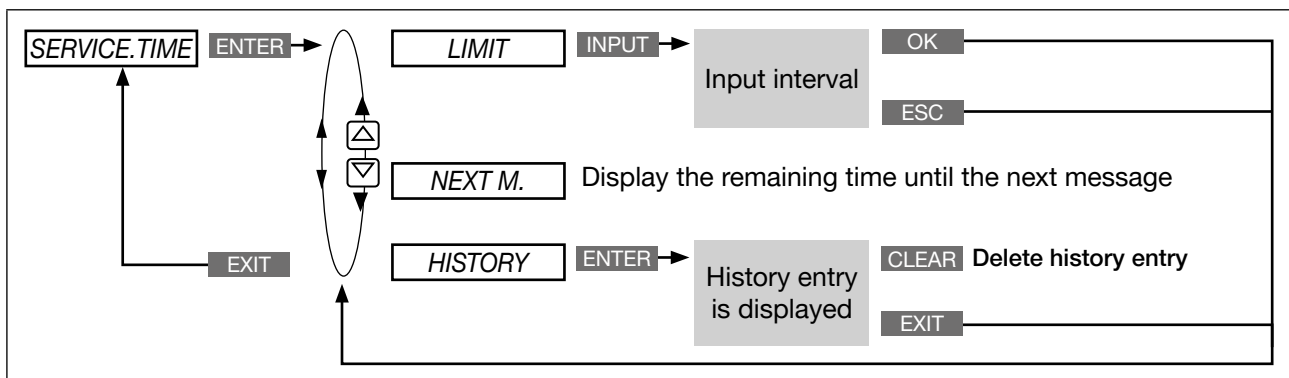


Fig. 92: Operating structure *SERVICE.TIME*

**Specifying interval for the output of messages**





Key	Action	Description
▲ / ▼	Select <i>SERVICE.TIME</i>	(To do this, the <i>SERVICE.TIME</i> function must be incorporated into the <i>DIAGNOSE</i> main menu. See Chapter “26.2.22.4. Activation of diagnosis functions”).
ENTER	Press 	The menu is displayed.
▲ / ▼	Select <i>LIMIT</i>	
INPUT	Press 	The preset value is displayed.
▲ / ▼	+ Increase value ← Change the (time unit: d/h/m)	Set interval for outputting the message.
OK	Press 	Return to the <i>SERVICE.TIME</i> menu.
EXIT	Press 	Return to the <i>DIAGNOSE</i> main menu.

Table 85: *SERVICE.TIME*; specifying interval.



**TRAVEL.ACCU** – Path accumulator

The path accumulator records and adds up the path which the actuator piston covers. A movement of the actuator piston is detected when the position changes by at least 1 %.

The interval for outputting messages is specified by inputting a limit for the total number of piston movements.

- To do this, a history entry is made in the *HISTORY* submenu. For description see “26.2.22.7. History entries in the *HISTORY* submenu”.
- The status signal, which is assigned to the message, is indicated at short intervals on the display. See also *D.MSG* and *CONFIG.MSG* in Chapter “26.2.22.5”, page 147.

Display <i>TRAVEL.ACCU</i>	Description of the functions
	<p>The <i>STROKE</i> submenu specifies the total stroke of the actuator piston. The total stroke is automatically determined during the basic setting of the device (running <i>X.TUNE</i>).</p> <p>In the case of an analog position sensor, the total stroke must be input by pressing the <b>INPUT</b> key.</p> <p>The interval for outputting the message can be changed in the <i>LIMIT</i> submenu. A piston movement which covers 10 km has been preset at the factory.</p> <p>After <i>NEXT.M</i> the remaining piston movement distance is displayed until the next message appears.</p> <p>The history entries of the last 3 messages can be viewed and deleted in the <i>HISTORY</i> submenu.</p>

Table 86: *TRAVEL.ACCU*; path accumulator

Operating structure:

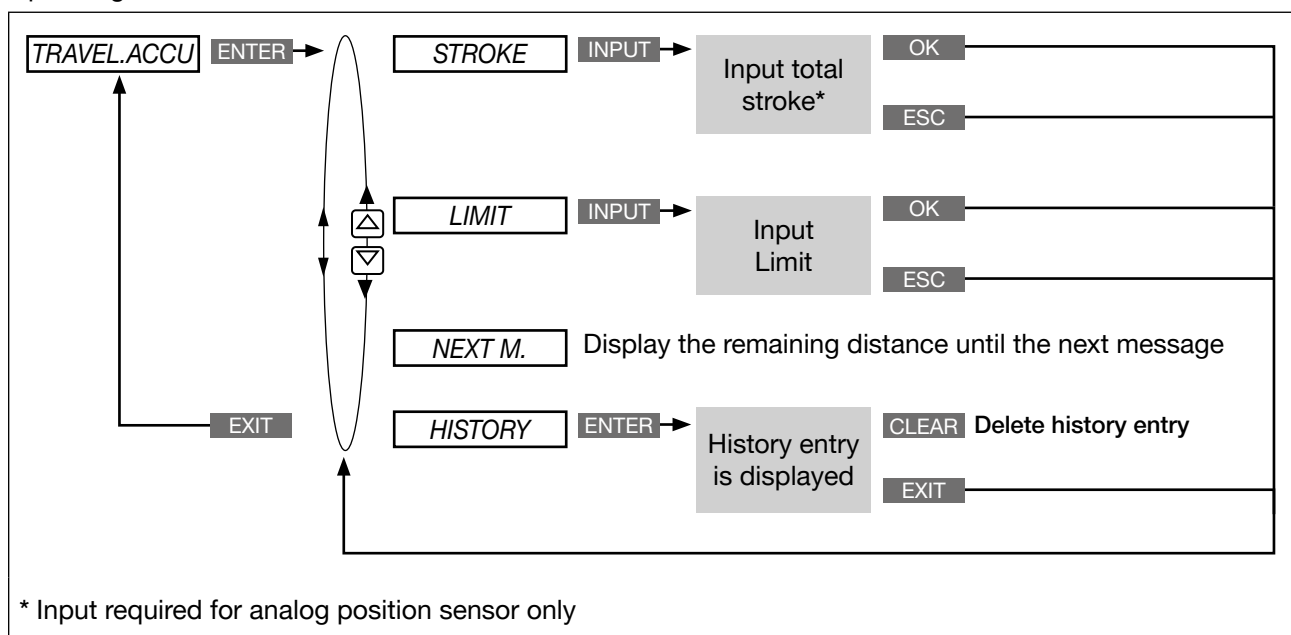


Fig. 93: Operating structure *TRAVEL.ACCU*

MAN 1000118577 EN Version: K Status: RL (released | freigegeben) printed: 05.08.2022

**Specifying interval for the output of messages**










Key	Action	Description
▲ / ▼	Select <i>TRAVEL.ACCU</i>	(To do this, the <i>TRAVEL.ACCU</i> function must be incorporated into the <i>DIAGNOSE</i> main menu. See Chapter “26.2.22.4. Activation of diagnosis functions”).
ENTER	Press 	The menu is displayed.
* Required for analog position sensor only (setting the <i>STROKE</i> submenu)		
▲ / ▼ *	Select <i>STROKE</i>	
INPUT *	Press 	The preset value is displayed.
▲ / ▼ *	 Increase value  Changing the decimal place	Set total stroke of the actuator piston.
▲ / ▼	Select <i>LIMIT</i>	
INPUT	Press 	The preset value is displayed.
▲ / ▼	 Increase value  Changing the decimal place	Setting interval for outputting the message (limit for total number of piston movements).
OK	Press 	Return to the <i>TRAVEL.ACCU</i> menu.
EXIT	Press 	Return to the <i>DIAGNOSE</i> main menu.

Table 87: *TRAVEL.ACCU*; specifying interval.

**CYCLE.COUNTER** – Direction reversal counter

The direction reversal counter counts the number of changes in direction of the actuator piston. A change in direction is detected when the position of the actuator piston changes by at least 1 %.

The interval for outputting messages is specified by inputting a limit for the total number of changes in direction.

- To do this, a history entry is made in the *HISTORY* submenu. For description see “26.2.22.7. History entries in the *HISTORY* submenu”.
- The status signal, which is assigned to the message, is indicated at short intervals on the display. See also *D.MSG* and *CONFIG.MSG* in Chapter “26.2.22.5”, page 147.

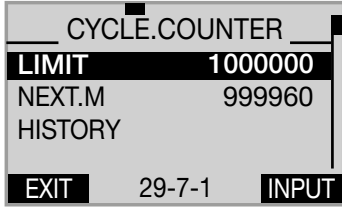
Display <i>CYCLE.COUNTER</i>	Description of the functions
	<p>The interval for outputting the message can be changed in the <i>LIMIT</i> submenu. 1 million changes in direction have been preset at the factory.</p> <p>After <i>NEXT.M</i> the remaining changes in direction are displayed until the next message appears.</p> <p>The history entries of the last 3 messages can be viewed and deleted in the <i>HISTORY</i> submenu.</p>

Table 88: *SERVICE.TIME*; operating-hours counter

Operating structure:

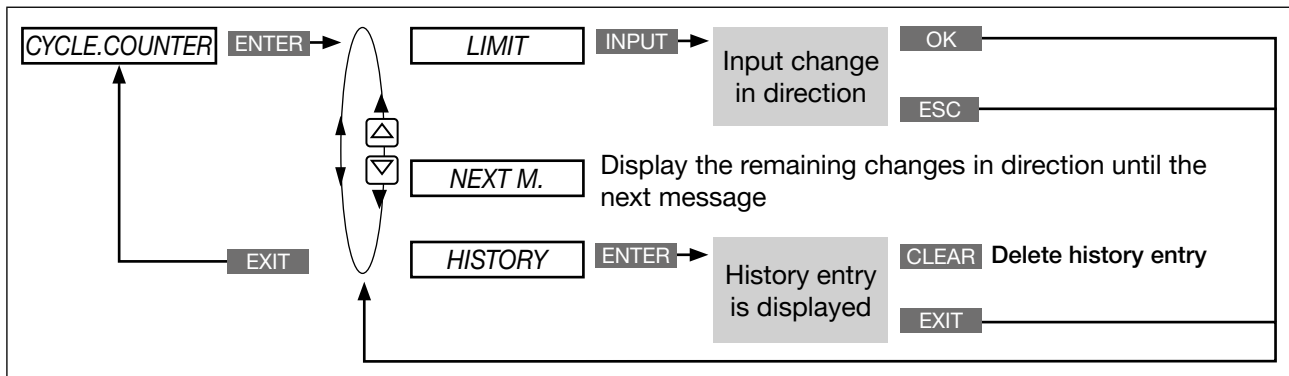


Fig. 94: Operating structure CYCLE.COUNTER

### Specifying interval for the output of messages

Key	Action	Description
▲ / ▼	Select <b>CYCLE.COUNTER</b>	(To do this, the <b>CYCLE.COUNTER</b> function must be incorporated into the <b>DIAGNOSE</b> main menu. See Chapter “26.2.22.4. Activation of diagnosis functions”.)
ENTER	Press	The menu is displayed.
▲ / ▼	Select <b>LIMIT</b>	
INPUT	Press	The preset value is displayed.
▲ / ▼	+ Increase value ← Changing the decimal place	Setting interval for outputting the message (limited number of changes in direction).
OK	Press	Return to the <b>CYCLE.COUNTER</b> menu.
EXIT	Press	Return to the <b>DIAGNOSE</b> main menu.

Table 89: CYCLE.COUNTER; specifying interval.

### **TEMP.CHECK** – Temperature monitor

The temperature monitor checks whether the current temperature is within the specified temperature range. The temperature range is specified by inputting a minimum and maximum temperature. If the temperature deviates from the specified range, a message is output.

- To do this, a history entry is made in the **HISTORY** submenu. For description see “26.2.22.7. History entries in the **HISTORY** submenu”.
- The status signal, which is assigned to the message, is indicated at short intervals on the display. See also **D.MSG** and **CONFIG.MSG** in Chapter “26.2.22.5”, page 147.

In addition to the monitor there is a temperature slave pointer. This indicates the lowest and highest of the measured temperature values. The slave pointer can be reset by pressing the **CLEAR** key.

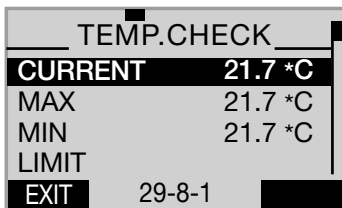
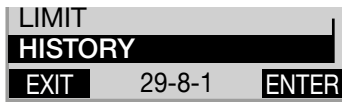
Display <i>TEMP.CHECK</i>	Description of the functions
	<p><i>CURRENT</i> indicates the current temperature.</p> <p><i>MAX</i> indicates the highest temperature of the slave pointer</p> <p><i>MIN</i> indicates the lowest temperature of the slave pointer</p> <p>The permitted temperature range can be changed in the <i>LIMIT</i> submenu. A message is output if the temperature goes outside the permitted range. The temperature range has been preset at the factory from 0...60 °C.</p>
	<p>The history entries of the last 3 messages can be viewed and deleted in the <i>HISTORY</i> submenu.</p>

Table 90: *TEMP.CHECK*; temperature range

Operating structure:

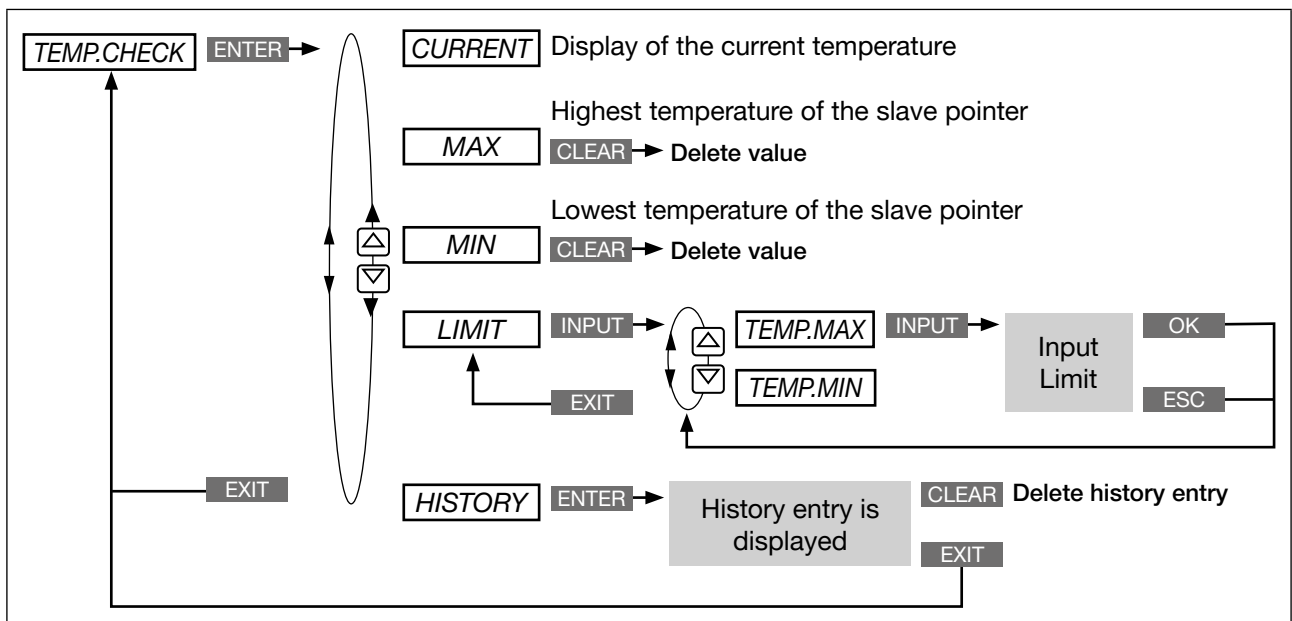





Fig. 95: Operating structure *TEMP.CHECK*

### Specifying temperature limit for the output of messages

Key	Action	Description
▲ / ▼	Select <i>TEMP.CHECK</i>	(To do this, the <i>TEMP.CHECK</i> function must be incorporated into the <i>DIAGNOSE</i> main menu. See Chapter “26.2.22.4. Activation of diagnosis functions”).
ENTER	Press 	The menu is displayed.
▲ / ▼	Select <i>LIMIT</i>	
ENTER	Press 	The upper and lower temperature limit is displayed. The upper limit <i>TEMP.MAX</i> has already been selected.
INPUT	Press 	Open input screen for upper temperature limit.

Key	Action	Description
▲ / ▼	+ Increase value ← Changing the decimal place	Input upper temperature limit <i>TEMP.MAX</i> .
OK	Press	Acknowledge value.
▲ / ▼	Select <i>TEMP.MIN</i>	
INPUT	Press	Open factory setting for lower temperature limit.
▲ / ▼	+ Increase value ← Changing the decimal place	Input lower temperature limit <i>TEMP.MIN</i> .
OK	Press	Acknowledge value.
EXIT	Press	Return to the <i>TEMP.CHECK</i> menu.
EXIT	Press	Return to the <i>DIAGNOSE</i> main menu.

Table 91: *TEMP.CHECK*; specifying temperature limit.

**STROKE.CHECK** – End position monitor

The *STROKE.CHECK* function is used to monitor the physical end positions of the armature. In this way wear marks can be detected on the valve seat.

To do this, a tolerance band is specified for the lower end position (position 0 %) and for the upper end position (position 100 %). If an end position exceeds or falls below the tolerance band, a message is output.

- To do this, a history entry is made in the *HISTORY* submenu. For description see “26.2.22.7. History entries in the *HISTORY* submenu”.
- The status signal, which is assigned to the message, is indicated at short intervals on the display. See also *D.MSG* and *CONFIG.MSG* in Chapter “26.2.22.5”, page 147.

In addition to the monitor there is an end position slave pointer. This indicates the minimum and maximum position of the determined end positions. The slave pointer can be reset by pressing the **CLEAR** key.

Display <i>STROKE.CHECK</i>	Description of the functions
	<p><i>MAX</i> indicates the maximum position of the slave pointer</p> <p><i>MIN</i> indicates the minimum position of the slave pointer</p> <p>The tolerance band for the physical end positions can be set in the <i>LIMIT</i> submenu. A message is output if the temperature goes outside the permitted range.</p> <p>Example:                      Input upper end position <i>TOL MAX</i> = 1 %                      If the position is less than -1 %, a message is output</p> <p>Input lower end position <i>TOL ZERO</i> = 1 %                      If the position is greater than 101 %, a message is output</p> <p>The history entries of the last 3 messages can be viewed and deleted in the <i>HISTORY</i> submenu.</p>

Table 92: *STROKE.CHECK*; end position monitor

MAN 1000118577 EN Version: K Status: RL (released | freigegeben) printed: 05.08.2022

**CAUTION!**



If a stroke limit was set in the *X.LIMIT* menu, the mechanical end position monitor has only limited relevance.

The end positions indicated on the process level under *POS* are not the physically caused end positions in this case. Therefore they cannot be compared with the end positions indicated in the *STROKE.CHECK* menu under *MIN* and *MAX*.

Operating structure:

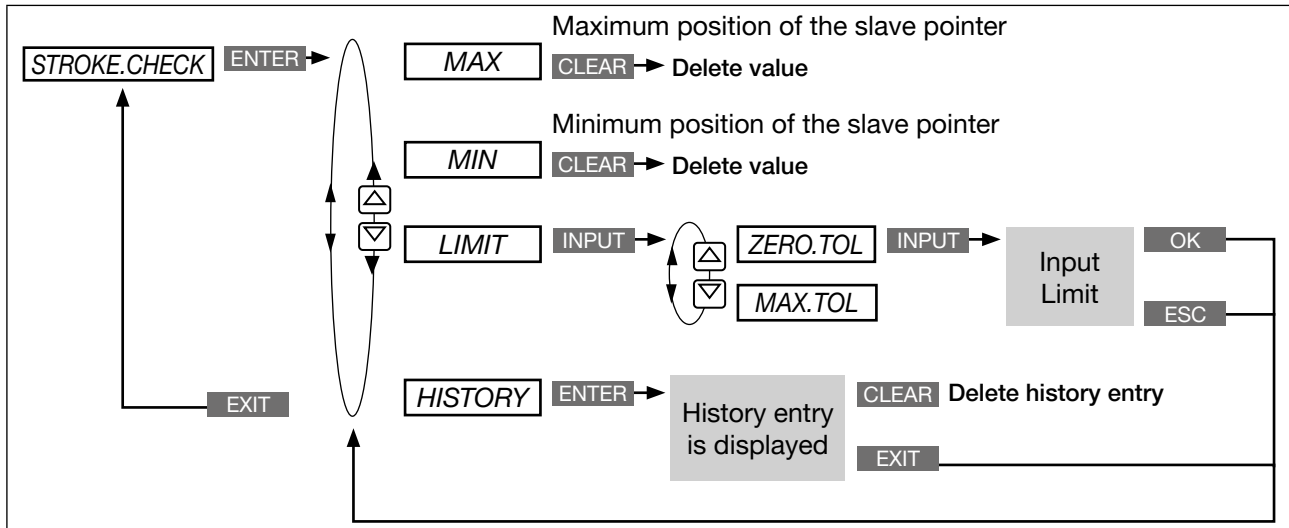


Fig. 96: Operating structure *STROKE.CHECK*

**Specifying position limit for the output of messages**

Key	Action	Description
▲ / ▼	Select <i>STROKE.CHECK</i>	(To do this, the <i>STROKE.CHECK</i> function must be incorporated into the <i>DIAGNOSE</i> main menu. See Chapter “26.2.22.4. Activation of diagnosis functions”).
ENTER	Press	The menu is displayed.
▲ / ▼	Select <i>LIMIT</i>	
ENTER	Press	The submenus for inputting the lower and upper end position tolerance are displayed. The submenu for inputting the lower end position tolerance <i>ZERO.TOL</i> has already been selected.
INPUT	Press	Open input screen for lower end position tolerance.
▲ / ▼	+ Increase value - Changing the decimal place	Input lower end position tolerance <i>ZERO.TOL</i> .
OK	Press	Acknowledge value.
▲ / ▼	Select <i>MAX.TOL</i>	
INPUT	Press	Open input screen for upper end position tolerance.
▲ / ▼	+ Increase value - Changing the decimal place	Input upper end position tolerance <i>MAX.TOL</i> .

Key	Action	Description
OK	Press	Acknowledge value.
EXIT	Press	Return to the <i>STROKE.CHECK</i> menu.
EXIT	Press	Return to the <i>DIAGNOSE</i> main menu.

Table 93: *STROKE.CHECK*; end position monitor.

**POS.MONITOR** –Position monitoring

The *POS.MONITOR* function monitors the current position of the actuator.

The tolerance band for the set-point value is specified in the *DEADBAND* submenu.

A period for alignment of the actual value with the set-point value is specified in the *COMP.TIME* submenu (compensation time).

The compensation time *COMP.TIME* starts recording as soon as the set-point value is constant. When the compensation time has elapsed, monitoring starts.

If the control deviation (*DEV*) of the actual value is greater than the tolerance band of the set-point value during monitoring, a message is output.

- To do this, a history entry is made in the *HISTORY* submenu. For description see “26.2.22.7. History entries in the *HISTORY* submenu”.
- The status signal, which is assigned to the message, is indicated at short intervals on the display. See also *D.MSG* and *CONFIG.MSG* in Chapter “26.2.22.5”, page 147.

Display <i>POS.MONITOR</i>	Description of the functions
	<p>The tolerance band of the set-point value preset at the factory to 2 % can be changed in the <i>DEADBAND</i> submenu.</p> <p>The compensation time is set in <i>COMP.TIME</i> (compensation time).</p> <p>The history entries of the last 3 messages can be viewed and deleted in the <i>HISTORY</i> submenu.</p>

Table 94: *POS.MONITOR*; position monitor

Schematic representation

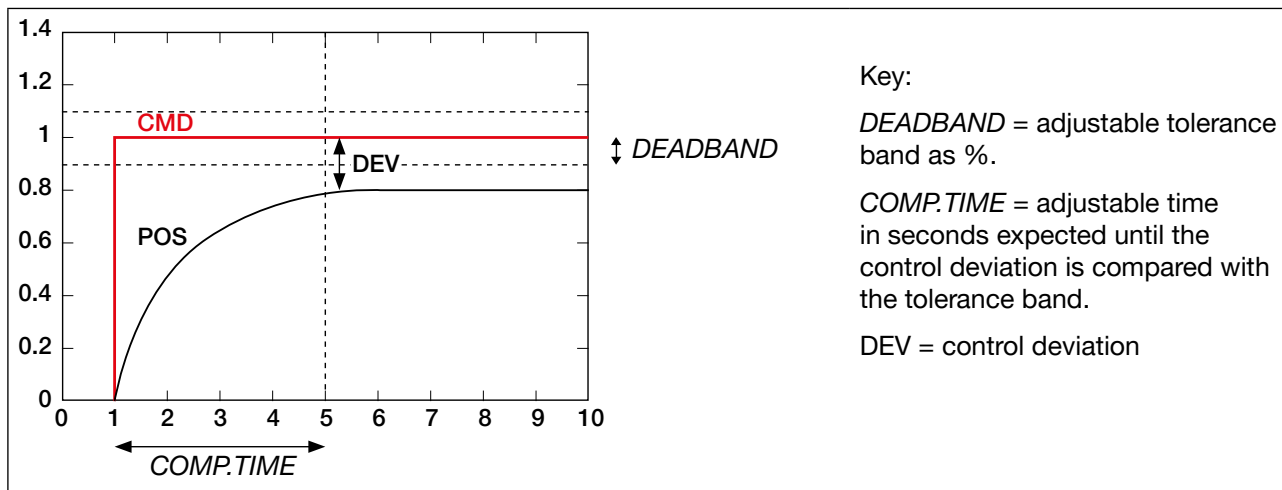


Fig. 97: *POS.MONITOR*; schematic representation of position monitor

Operating structure:

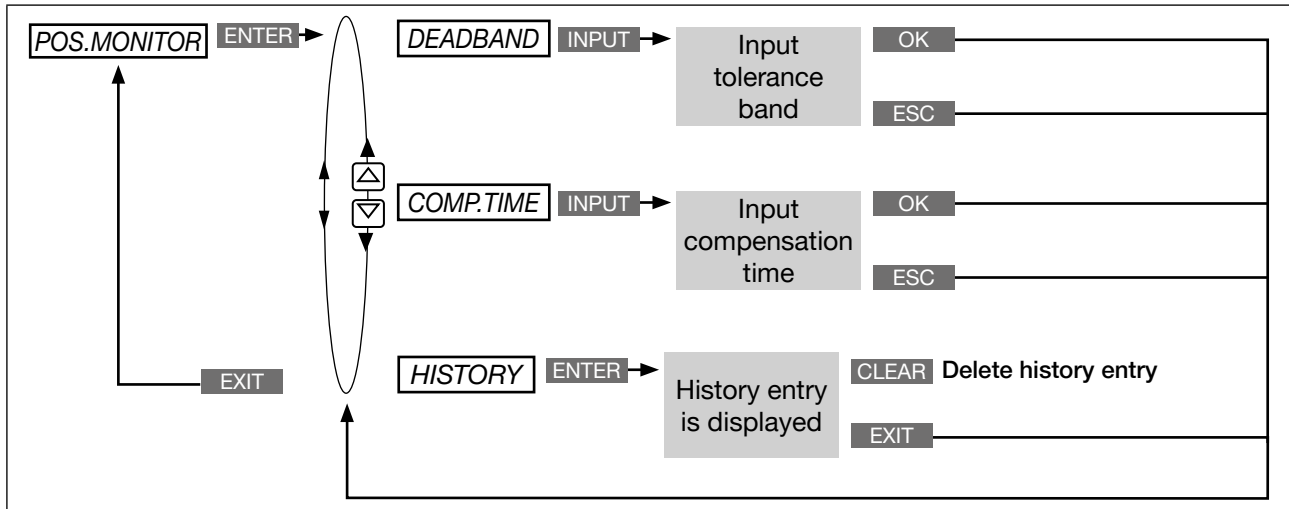


Fig. 98: Operating structure POS.MONITOR

### Inputting tolerance band and compensation time

Key	Action	Description
▲ / ▼	Select <i>POS.MONITOR</i>	(To do this, the <i>POS.MONITOR</i> function must be incorporated into the <i>DIAGNOSE</i> main menu. See Chapter “26.2.22.4. Activation of diagnosis functions”).
ENTER	Press	The menu is displayed. <i>DEADBAND</i> has already been selected.
INPUT	Press	The preset value is displayed.
▲ / ▼	+ Increase value ← Changing the decimal place	Input tolerance band.
OK	Press	Acknowledge value.
▲ / ▼	Select <i>COMP.TIME</i>	
INPUT	Press	The preset value is displayed.
▲ / ▼	+ Increase value ← Changing the decimal place	Input compensation time.
OK	Press	Return to the <i>POS.MONITOR</i> menu.
EXIT	Press	Return to the <i>DIAGNOSE</i> main menu.

Table 95: *POS.MONITOR*; specifying tolerance band and compensation time.

### **PV.MONITOR** – Process monitor (for Type 8793 only)

The *PV.MONITOR* function monitors the process actual value.

The operating menu is identical to the position monitor *POS.MONITOR* described above. In contrast, it is not the position of the actuator which is monitored here but the process.



### 25.2.22.7. History entries in the *HISTORY* submenu

Each diagnosis function, which can output a message, has the *HISTORY* submenu.

When the diagnosis message is actuated, a history entry is created with date and value. The history entries of the respective diagnosis function can be viewed and deleted in the *HISTORY* submenu.

A maximum of three history entries are stored from each diagnosis message. If three history entries are already available when a message is actuated, the oldest history entry is deleted.

Example: History of the diagnosis function *TRAVEL.ACCU*

TRAVEL.ACCU	
DATE	VALUE
01.02.12	5 cm
01.02.12	35 cm
01.02.12	10 cm
<b>EXIT</b>	<b>CLEAR</b>

Description:

On the left of the display is the date and on the right the associated value.

Deleting the history:

Hold down the **CLEAR** key until the countdown (5...) is running.



The *RESET.HISTORY* diagnosis menu can be used to jointly delete the histories of all diagnosis functions. See Chapter "[26.2.22.5](#)".

#### Deleting the histories of a diagnosis function in the example *TRAVEL.ACCU*






Key	Action	Description
▲ / ▼	Select <i>TRAVEL.ACCU</i>	
<b>ENTER</b>	Press 	The menu is displayed.
▲ / ▼	Select <i>HISTORY</i>	
<b>INPUT</b>	Press 	History entries with date and value are displayed.
<b>CLEAR</b>	 Hold down as long as countdown (5 ...) is running	The histories of the <i>TRAVEL.ACCU</i> diagnosis function are deleted.
<b>EXIT</b>	Press 	Return to the <i>TRAVEL.ACCU</i> menu.
<b>EXIT</b>	Press 	Return to the <i>DIAGNOSE</i> main menu.

Table 96: *SERVICE.TIME*; inputting interval for message.

#### CAUTION!



History entries are only created when the *CLOCK* function for the display has been activated on the process level.

To receive correct history entries, date and time must be correct.

Date and time must be reset after a restart. Therefore, the device switches immediately and automatically to the corresponding input menu after a restart.



For activation and setting of *CLOCK* see Chapter "[17.4.1 Setting date and time:](#)"

## 25.3 Manual configuration of X.TUNE

**!** This function is needed for special requirements only.  
For standard applications the X.TUNE function has been preset at the factory.  
See chapter "23.2 X.TUNE – Automatic adjustment of the positioner".

For special requirements the X.TUNE function, as described below, can be manually configured.

### Opening the menu for the manual configuration of X.TUNE

Key	Action	Description
<b>MENU</b>	Press  for approx. 3 s	Switching from process level ⇌ setting level.
<b>▲ / ▼</b>	Select X.TUNE	
<b>RUN</b>	Briefly press 	Opening the <i>Manual.TUNE</i> menu. The menu options for the manual configuration of X.TUNE are displayed.

X.TUNE; opening the menu for the manual configuration of X.TUNE

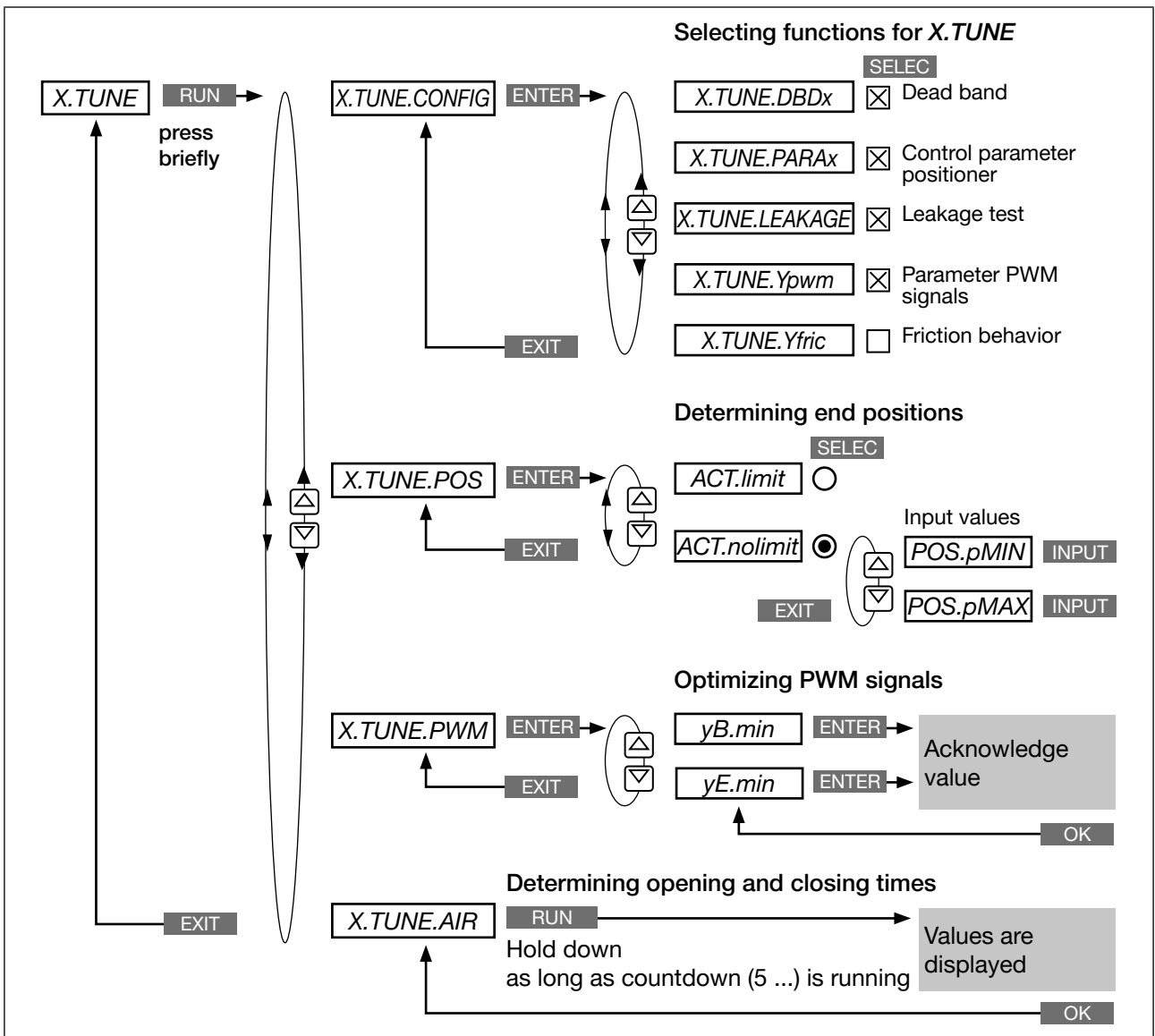


Fig. 99: Operating structure for the manual configuration of X.TUNE

## 25.3.1 Description of the menu for the manual configuration of X.TUNE

<b>X.TUNE.CONFIG</b>	Configuration of the <i>X.TUNE</i> function	Specify which functions are to be executed when <i>X.TUNE</i> is running (automatic self-optimization).
<b>M.TUNE.POS</b>	Position of the end positions	<ul style="list-style-type: none"> <li>- Specify whether the pneumatic actuator has mechanical end positions.</li> <li>- Manual specification of the end positions</li> </ul> If there are no mechanical end positions available, these are not approached by the <i>X.TUNE</i> and must be manually specified.
<b>M.TUNE.PWM</b>	Optimization of the PWM signals	Manual optimization of the PWM signals for control of the aeration valves and bleed valves.  For optimization the valves must be aerated and bled. A progress bar on the display indicates the speed at which the valve is aerated or bled. The setting is optimum when the progress bar moves as slowly as possible.
<b>M.TUNE.AIR</b>	Determination of the opening and closing times of the actuator	Continuous determination of the opening and closing times of the actuator.

### 25.3.1.1. X.TUNE.CONFIG – Configuration of the X.TUNE function

In this menu you can specify which functions are to be executed when the *X.TUNE* function is running automatically.

#### Specifying the functions in X.TUNE.CONFIG




Key	Action	Description
▲ / ▼	Select <i>X.TUNE.CONFIG</i>	
ENTER	Press 	The functions for automatic self-parameterization by <i>X.TUNE</i> are displayed.
▲ / ▼	Select required function	
SELEC	Press 	Activate the function by checking the box <input type="checkbox"/> .
		Select all required functions in succession using the arrow keys ▲ / ▼ and activate by checking the box <input type="checkbox"/> .
EXIT	Press 	Return to the <i>Manual.TUNE</i> menu.

Table 97: X.TUNE.CONFIG; specifying the functions for automatic self-parameterization by X.TUNE

### 25.3.1.2. X.TUNE.POS – Setting of the end positions

In this menu you can specify whether the pneumatic actuator has mechanical end positions or not. If there are no mechanical end positions available, these are not approached by the X.TUNE and must be manually specified.

#### Position of the end positions











Key	Action	Description
▲ / ▼	Select <i>M.TUNE.POS</i>	
ENTER	Press 	The selection for <i>ACT.limit</i> = mechanical end positions available <i>ACT.nolimit</i> = mechanical end positions not available is displayed.
<b>If mechanical end positions are available</b>		
▲ / ▼	Select <i>ACT.limit</i>	
SELEC	Press 	The selection is marked by a filled circle ●.
EXIT	Press 	Return to the <i>Manual.TUNE menu</i> .
<b>If mechanical end positions are not available</b>		
▲ / ▼	Select <i>ACT.nolimit</i>	
SELEC	Press 	The <i>CAL.POS</i> submenu for inputting the end positions is opened.
▲ / ▼	Select <i>POS.pMIN</i>	
INPUT	Press 	The input screen for the value of the lower end position is opened.
▲ / ▼	OPN Open more CLS Close more	Approach lower end position of the valve.
OK	Press 	Transfer and simultaneous return to the <i>CAL.POS</i> menu.
▲ / ▼	Select <i>POS.pMAX</i>	
INPUT	Press 	The input screen for the value of the upper end position is opened.
▲ / ▼	OPN Open more CLS Close more	Approach upper end position of the valve.
OK	Press 	Transfer and simultaneous return to the <i>CAL.POS</i> menu.
EXIT	Press 	Return to the <i>M.TUNE.POS</i> menu.
EXIT	Press 	Return to the <i>Manual.TUNE</i> menu.

Table 98: *M.TUNE.POS*; position of the end positions

### 25.3.1.3. M.TUNE.PWM – Optimization of the PWM signals

In this menu the PWM signals for control of the aeration valves and bleed valves are manually optimized.

For optimization the actuator is aerated and bled. A progress bar on the display indicates the position of the actuator and the speed of aeration and deaeration.

The setting is optimum when the progress bar moves as slowly as possible.



#### WARNING!

Danger due to uncontrolled valve movement when the *M.TUNE.PWM* function is running.

When the *M.TUNE.PWM* function is running under operating pressure, there is an acute risk of injury.

- ▶ Never run *M.TUNE.PWM* while a process is running.
- ▶ Secure system against unintentional activation.

#### Optimization of the PWM signals











Key	Action	Description
▲ / ▼	Select <i>M.TUNE.PWM</i>	
ENTER	Press 	The submenu is displayed. <i>yB.min</i> = aeration valve <i>yE.min</i> = bleed valve
▲ / ▼	Select <i>yB.min</i>	Submenu for setting the PWM signal for the aeration valve.
ENTER	Press 	The input screen for setting the PWM signal is opened. The progress bar indicates the speed of aeration.
▲ / ▼	 Increase speed  Reduce speed	Minimize speed so that the progress bar moves as slowly as possible from left to right. <b>Caution!</b> Do not minimize speed to such an extent that the progress bar remains in one position.
OK	Press 	Transfer and simultaneous return to the <i>M.TUNE.PWM</i> menu.
▲ / ▼	Select <i>yE.min</i>	Submenu for setting the PWM signal for the bleed valve.
ENTER	Press 	The input screen for setting the PWM signal is opened. The progress bar indicates the speed of deaeration.
▲ / ▼	 Increase speed  Reduce speed	Minimize speed so that the progress bar moves as slowly as possible from right to left. <b>Caution!</b> Do not minimize speed to such an extent that the progress bar remains in one position.
OK	Press 	Transfer and simultaneous return to the <i>M.TUNE.PWM</i> menu.
EXIT	Press 	Return to the <i>Manual.TUNE</i> menu.

Table 99: *M.TUNE.PWM*; optimization of the PWM signals

### 25.3.1.4. *M.TUNE.AIR* – Determination of the opening and closing times

By running this function, the opening and closing times of the valve are determined continuously.

A change to the supply pressure will affect the aeration time which can be optimized in this way.

For the setting the effects, which a change to the supply pressure has on the aeration time, can be continuously monitored via the *M.TUNE.AIR* function.

#### Continuous determination of the opening and closing times





Key	Action	Description
▲ / ▼	Select <i>M.TUNE.AIR</i>	
<b>RUN</b>	 Hold down as long as countdown (5 ...) is running	The aeration and deaeration times are displayed. <i>time.open</i> = aeration <i>time.close</i> = deaeration
-	-	Change the supply pressure to adjust the aeration time. The changed aeration time is displayed continuously.
<b>EXIT</b>	Press 	Return to the <i>Manual.TUNE</i> menu.
<b>EXIT</b>	Press 	Return to the main menu (MAIN).
<b>EXIT</b>	Press 	Switching from setting level ⇔ process level.

Table 100: *M.TUNE.AIR*; continuous determination of the opening and closing times

## 26 OPERATING STRUCTURE AND FACTORY SETTINGS

The factory presets are highlighted in blue to the right of the menu in the operating structure.

Examples:

<input checked="" type="radio"/> / <input checked="" type="checkbox"/>	Menu options activated or selected at the factory
<input type="radio"/> / <input type="checkbox"/>	Menu options not activated or selected at the factory
2 %, 10 sec, ...	Values set at the factory

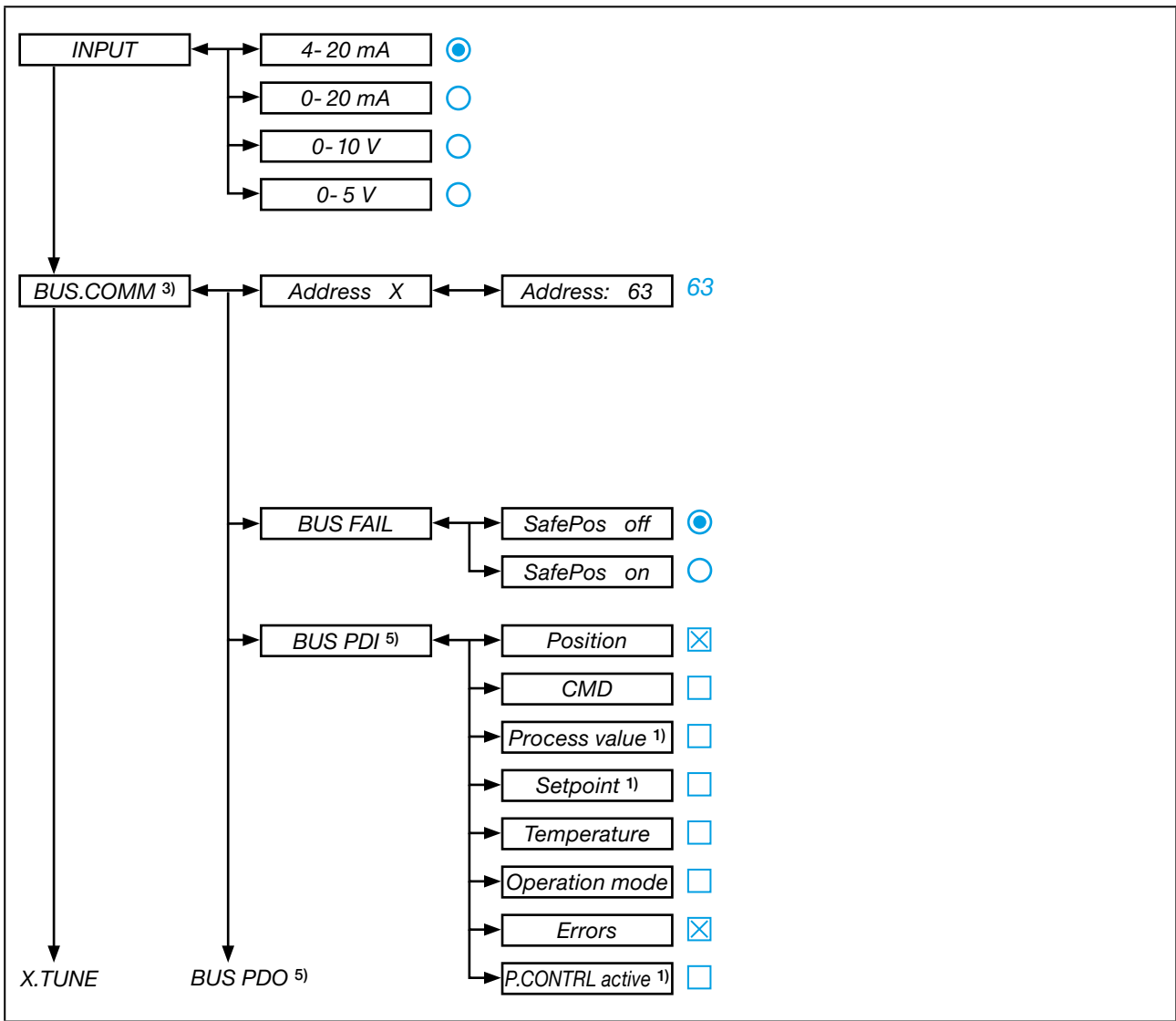


Fig. 100: Operating structure - 1

1) only process controller Type 8793  
 3) only field bus  
 5) only PROFIBUS DP

MAN 1000118577 EN Version: K Status: RL (released | freigegeben) printed: 05.08.2022

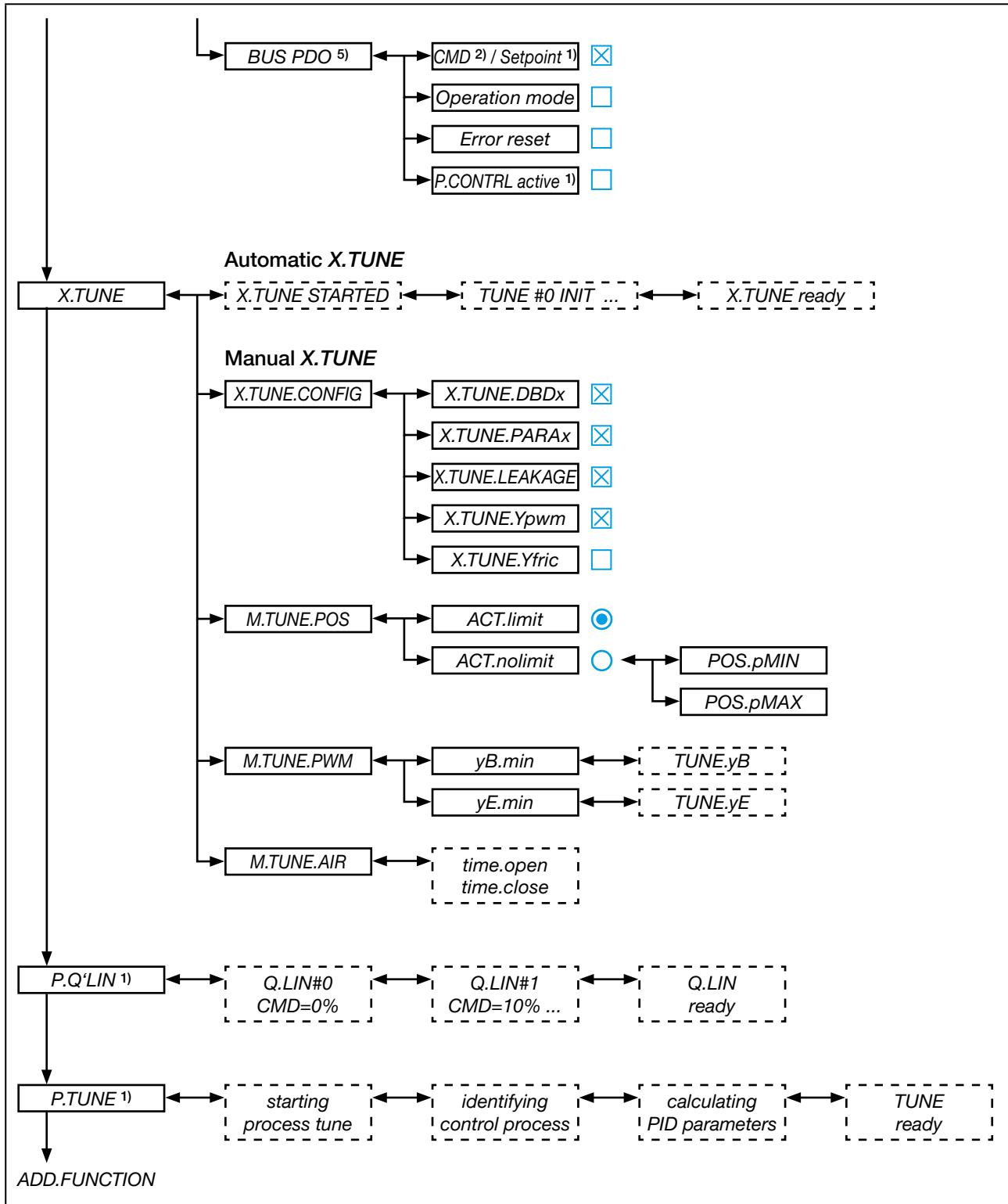
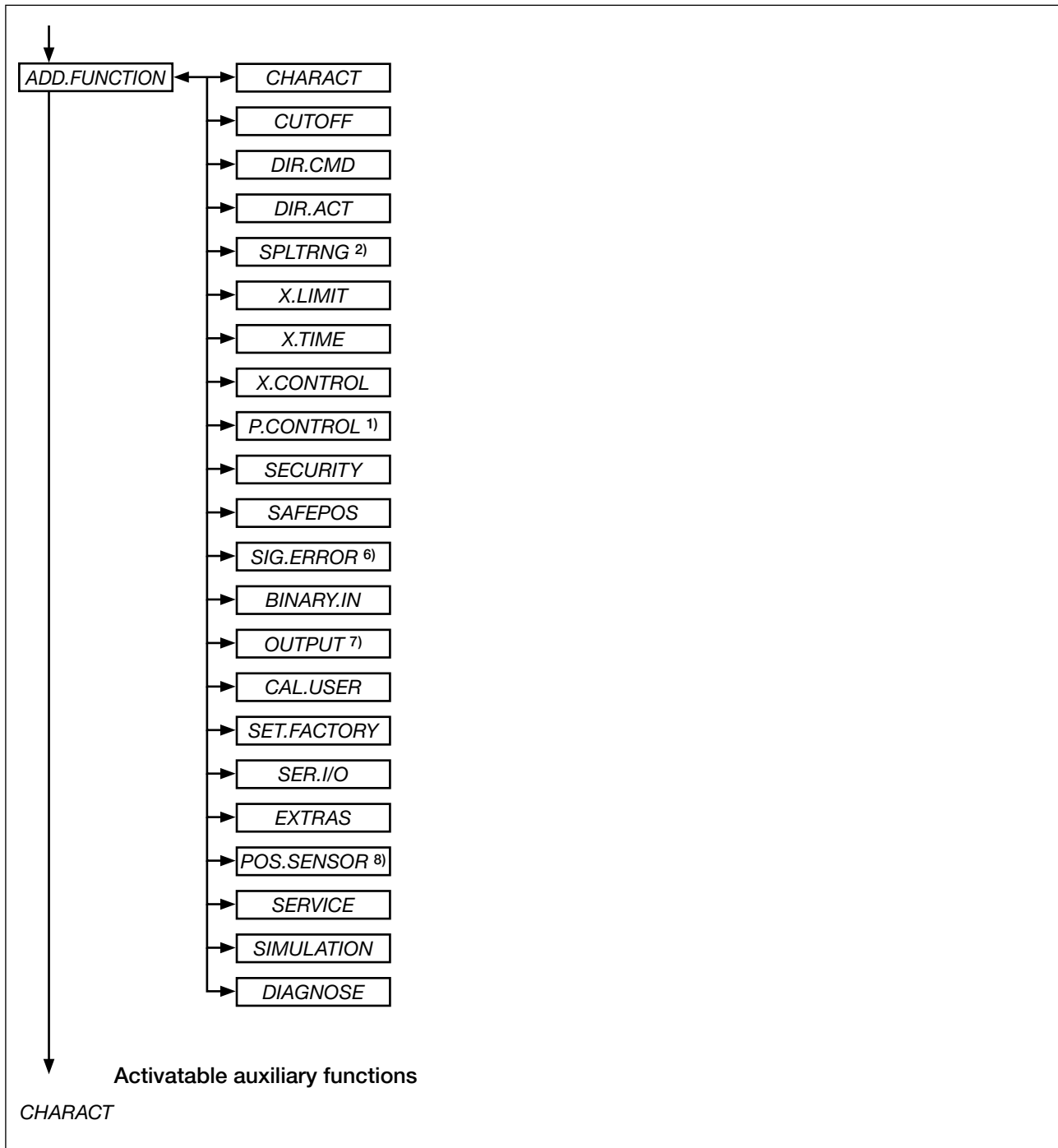


Fig. 101: Operating structure - 2

1) only process controller Type 8793  
2) only for positioner mode  
5) only PROFIBUS DP





MAN 1000118577 EN Version: K Status: RL (released | freigegeben) printed: 05.08.2022

Fig. 102: Operating structure - 3

- 1) only process controller Type 8793
- 2) only for positioner mode
- 6) only for signal type 4-20 mA and Pt 100
- 7) Optional. The number of outputs varies depending on the version.
- 8) for Type 8793 Remote only

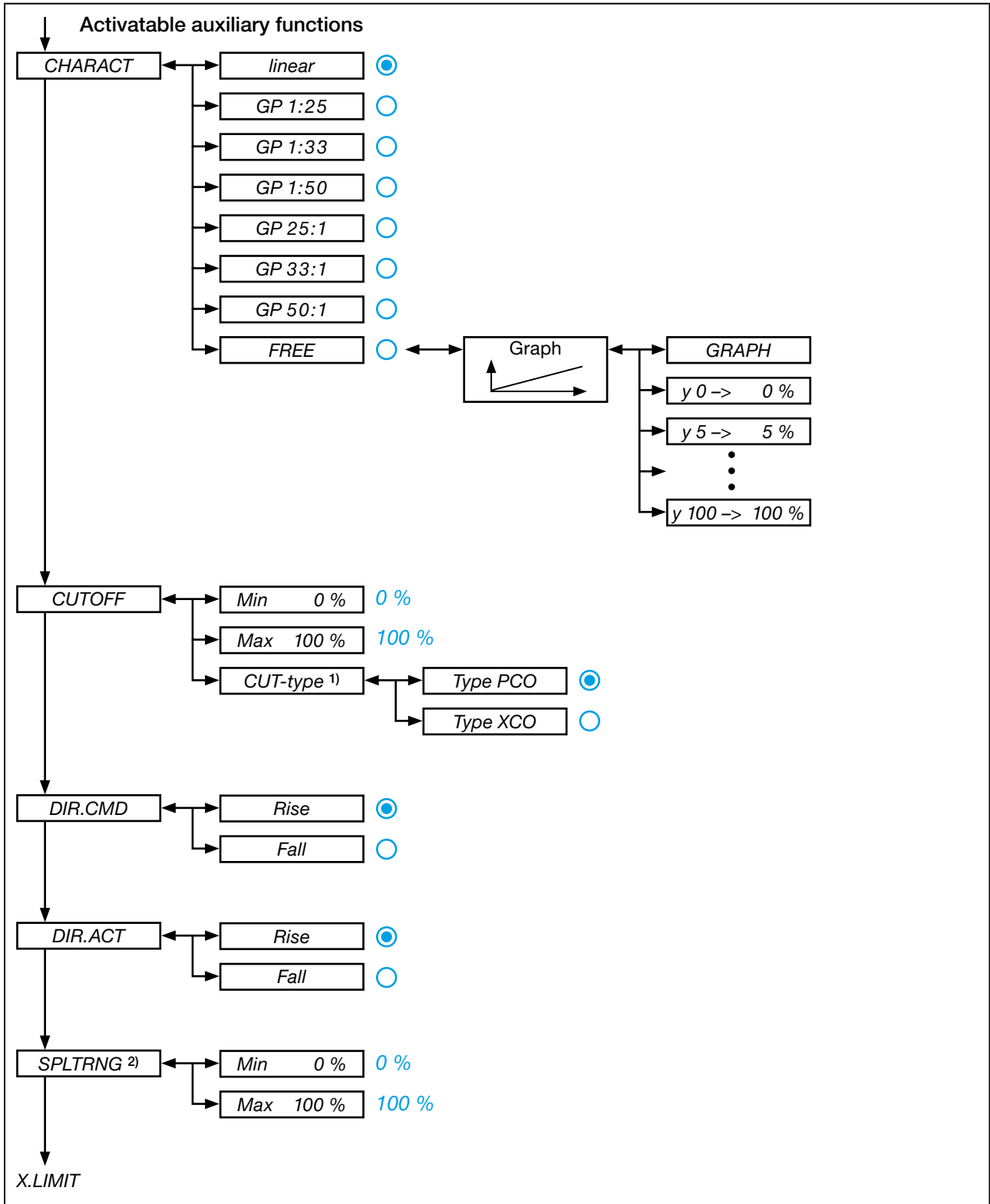


Fig. 103: Operating structure - 4

1) only process controller Type 8793  
2) only for positioner mode

MAN 1000118577 EN Version: K Status: RL (released | freigegeben) printed: 05.08.2022

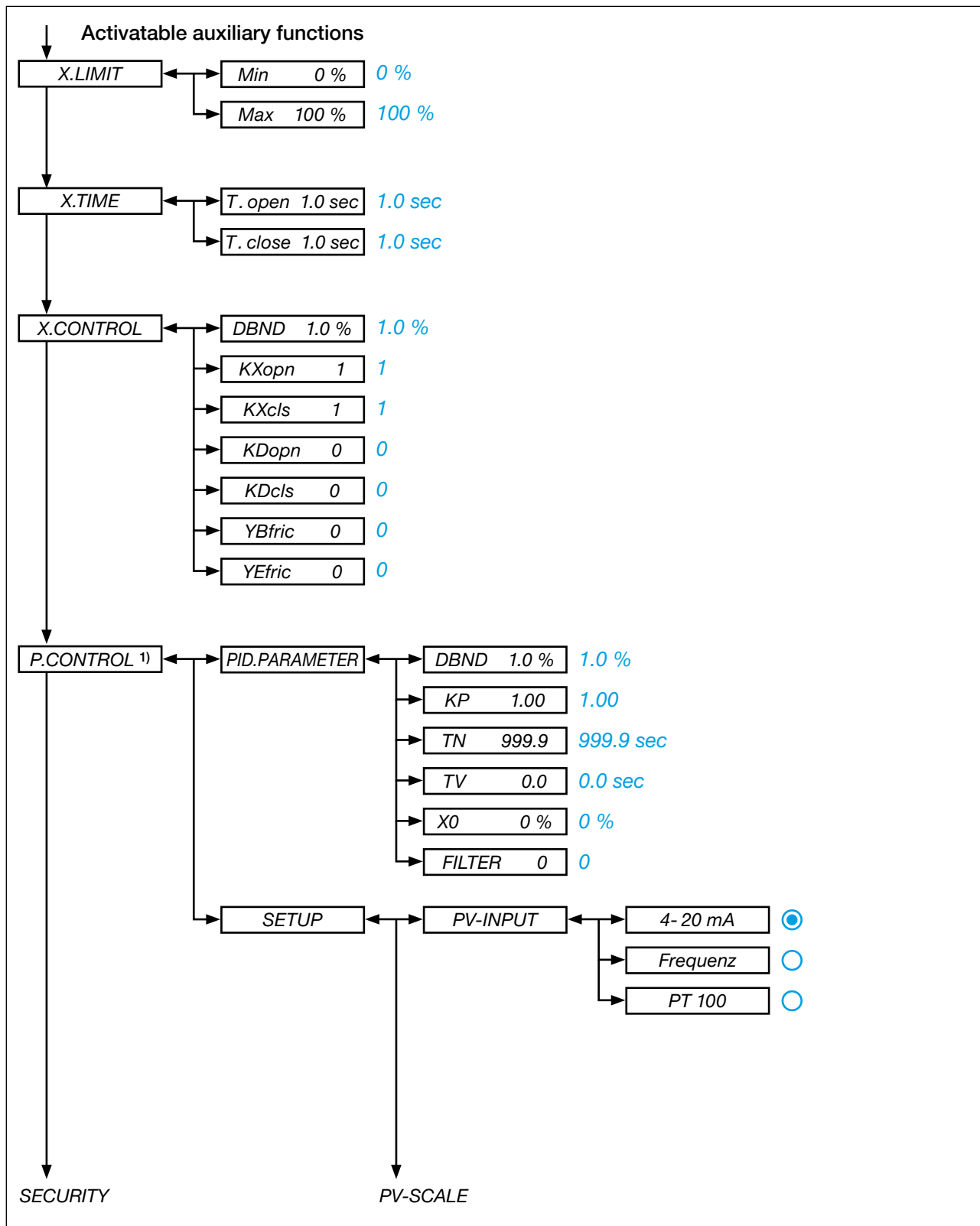


Fig. 104: Operating structure - 5

1) only process controller Type 8793

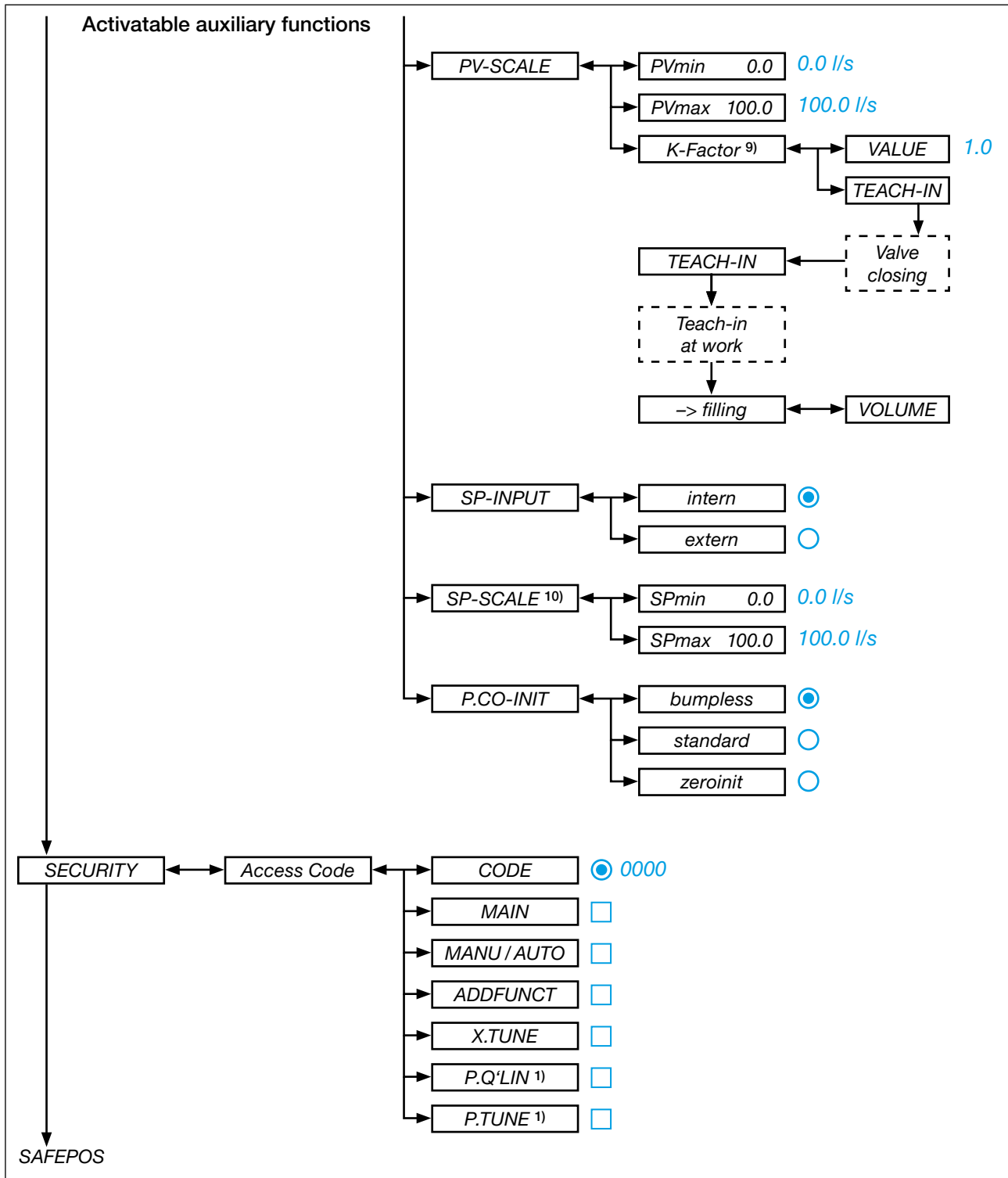


Fig. 105: Operating structure - 6

1) only process controller Type 8793

9) only for signal type frequency (P.CONTROL → SETUP → PV-INPUT → Frequency)

10) Only process controller Type 8793 and for external set-point value default (P.CONTROL → SETUP → SP-INPUT → external)

MAN 1000118577 EN Version: K Status: RL (released | freigegeben) printed: 05.08.2022

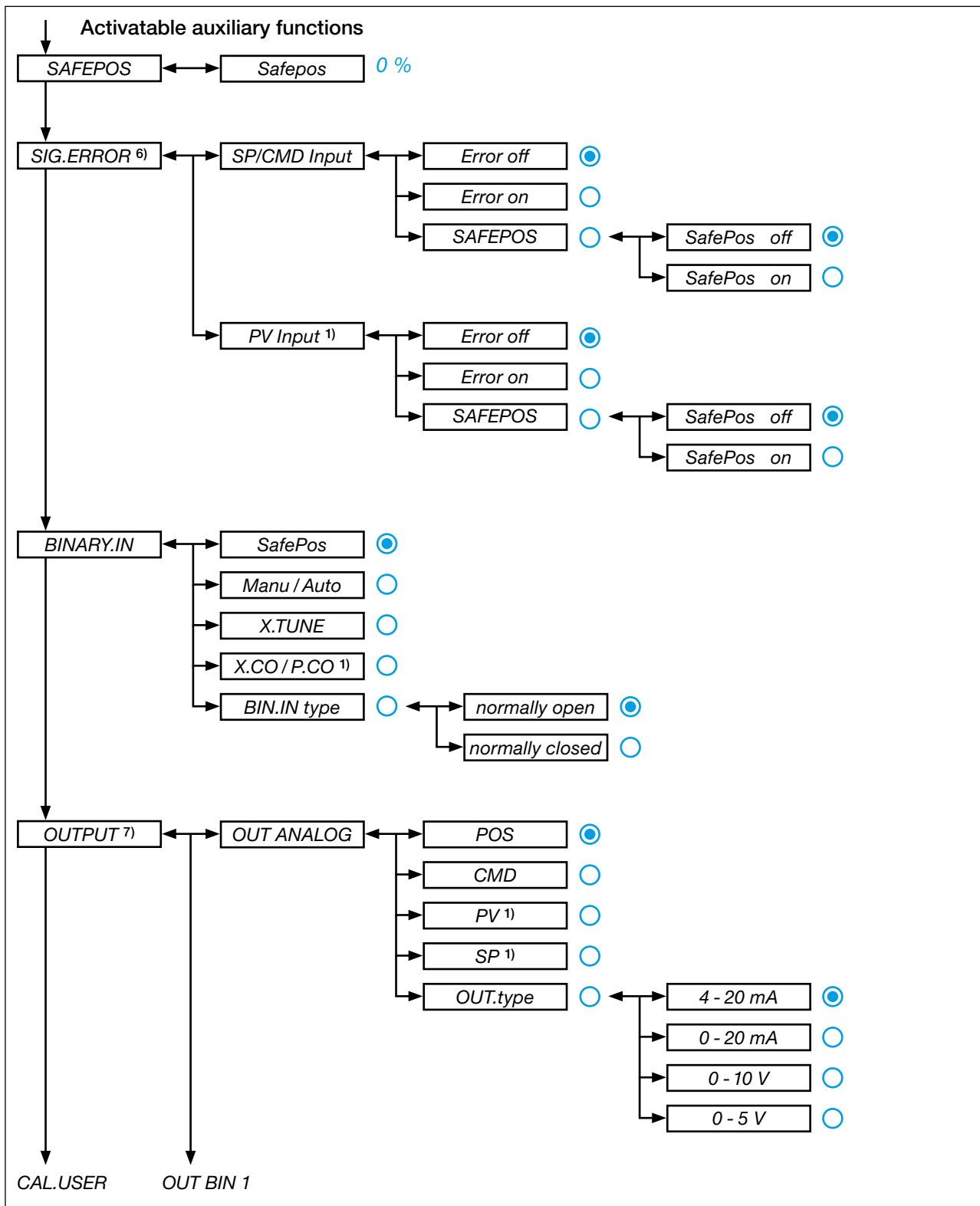


Fig. 106: Operating structure - 7

1) only process controller Type 8793  
 6) only for signal type 4-20 mA and Pt 100  
 7) Optional. The number of outputs varies depending on the version

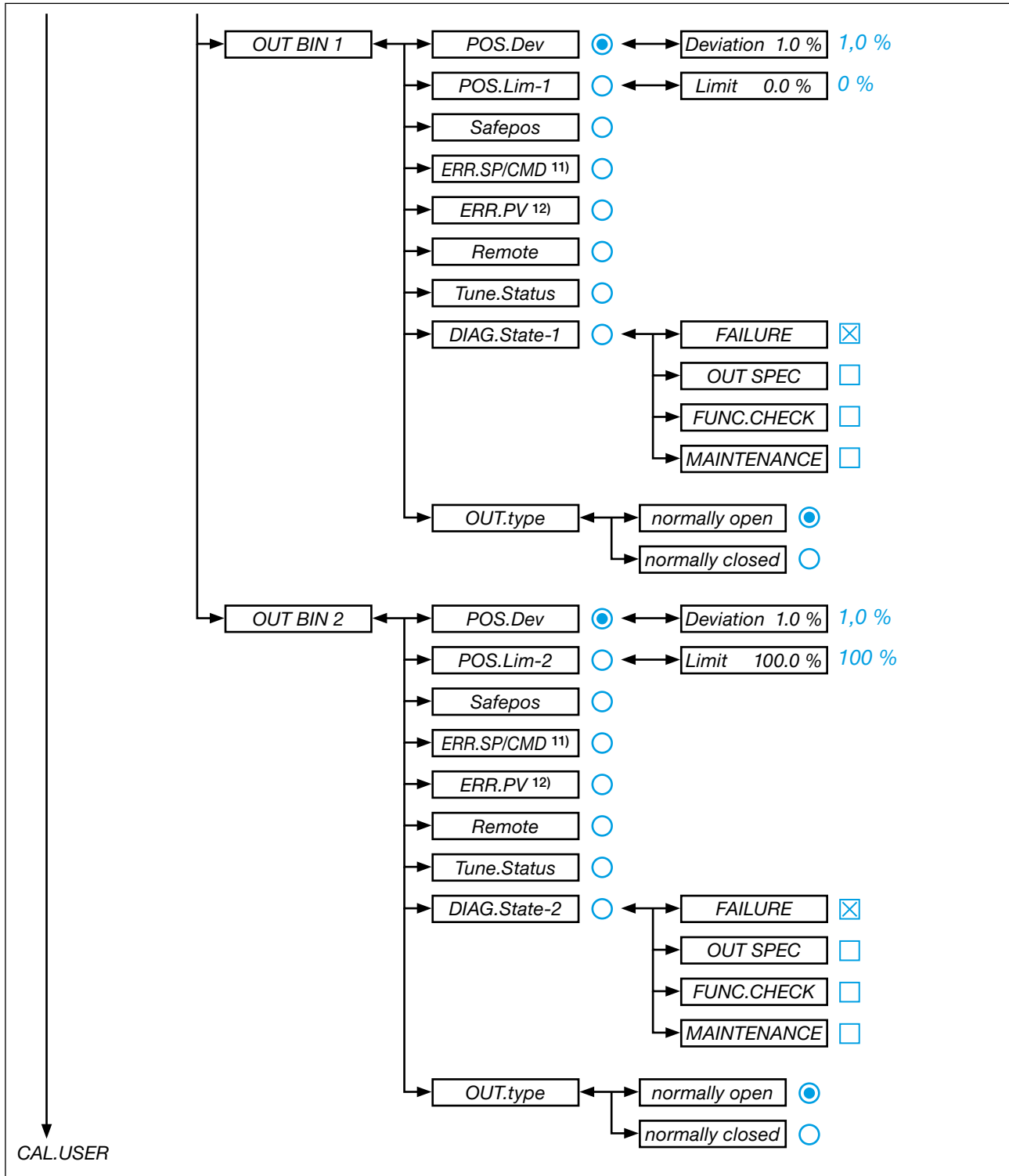
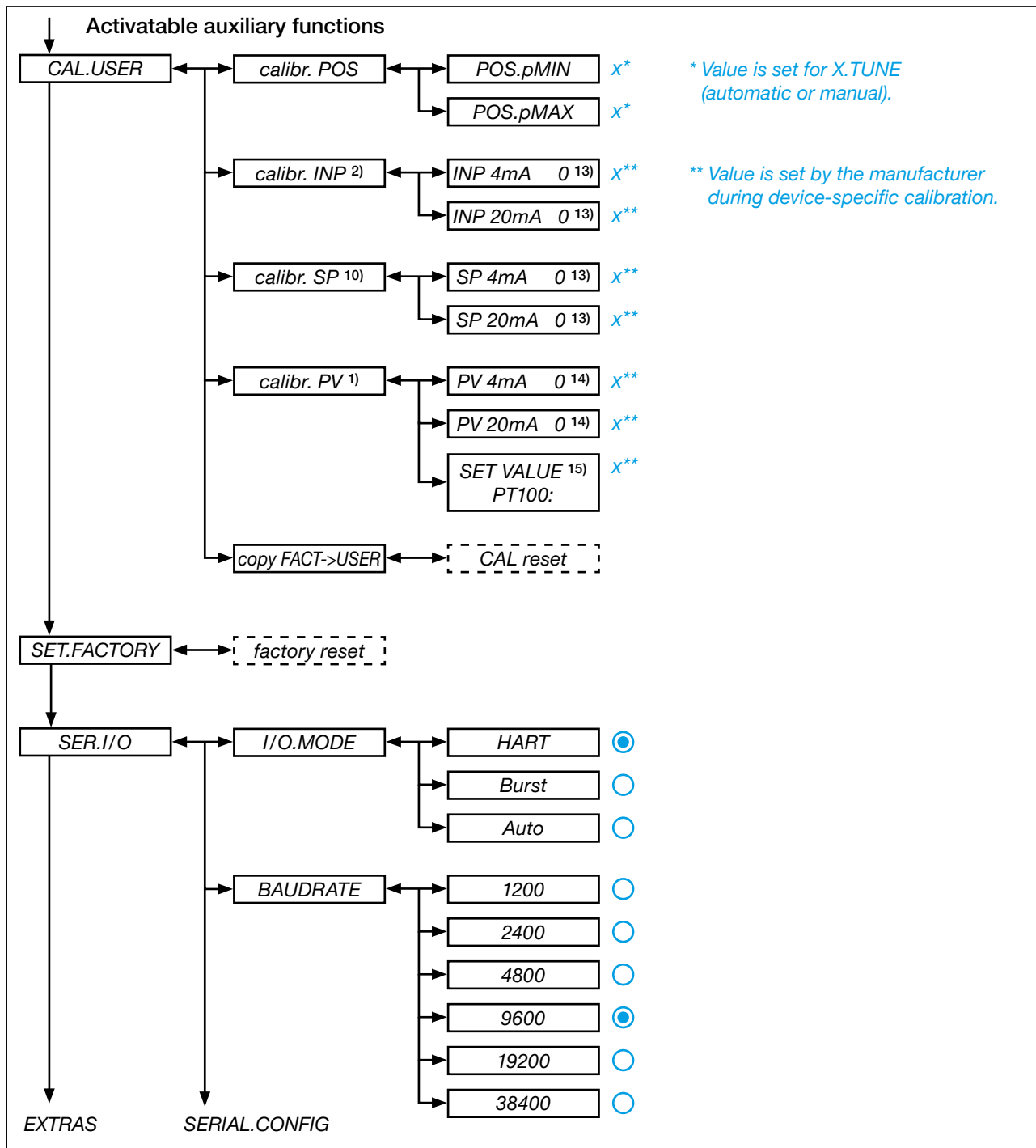


Fig. 107: Operating structure - 8

11) only if fault detection is activated for the input signal  
(SIG.ERROR → SP/CMD Input or PV-Input → Error on)

12) Only process controller Type 8793 and if fault detection is activated for the input signal  
(SIG.ERROR → SP/CMD Input or PV-Input → Error on)

MAN 1000118577 EN Version: K Status: RL (released | freigegeben) printed: 05.08.2022



\* Value is set for X.TUNE (automatic or manual).

\*\* Value is set by the manufacturer during device-specific calibration.

Fig. 108: Operating structure - 9

- 1) only process controller Type 8793
- 2) only for positioner mode
- 10) Only process controller Type 8793 and for external set-point value default (P.CONTROL → SETUP → SP-INPUT → extern)
- 13) The signal type is displayed which is selected in the INPUT menu
- 14) Only for signal type 4-20 mA (P.CONTROL → SETUP → PV-INPUT → 4-20 mA)
- 15) Only for circuit with Pt 100 (P.CONTROL → SETUP → PV-INPUT → PT 100)

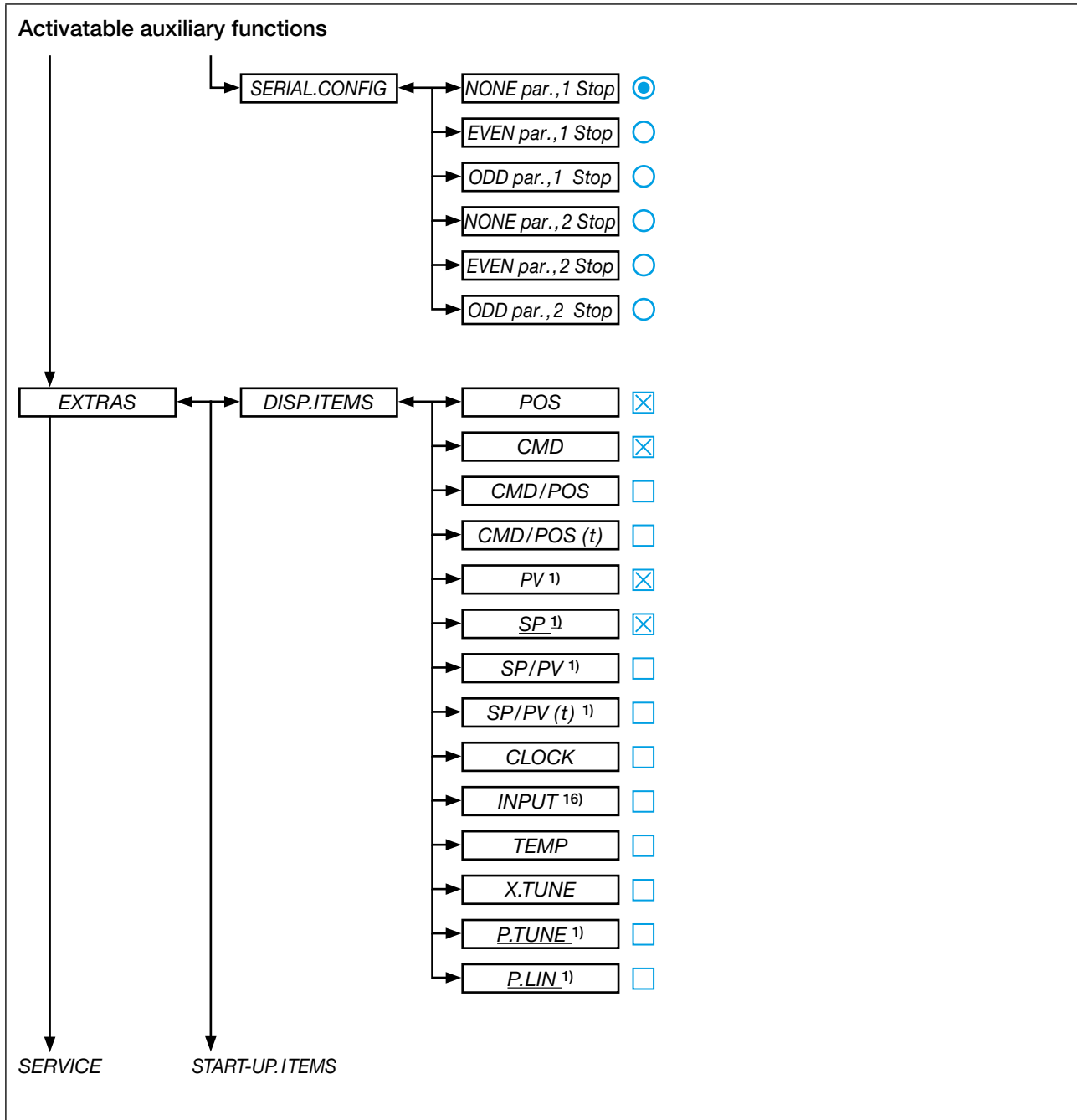
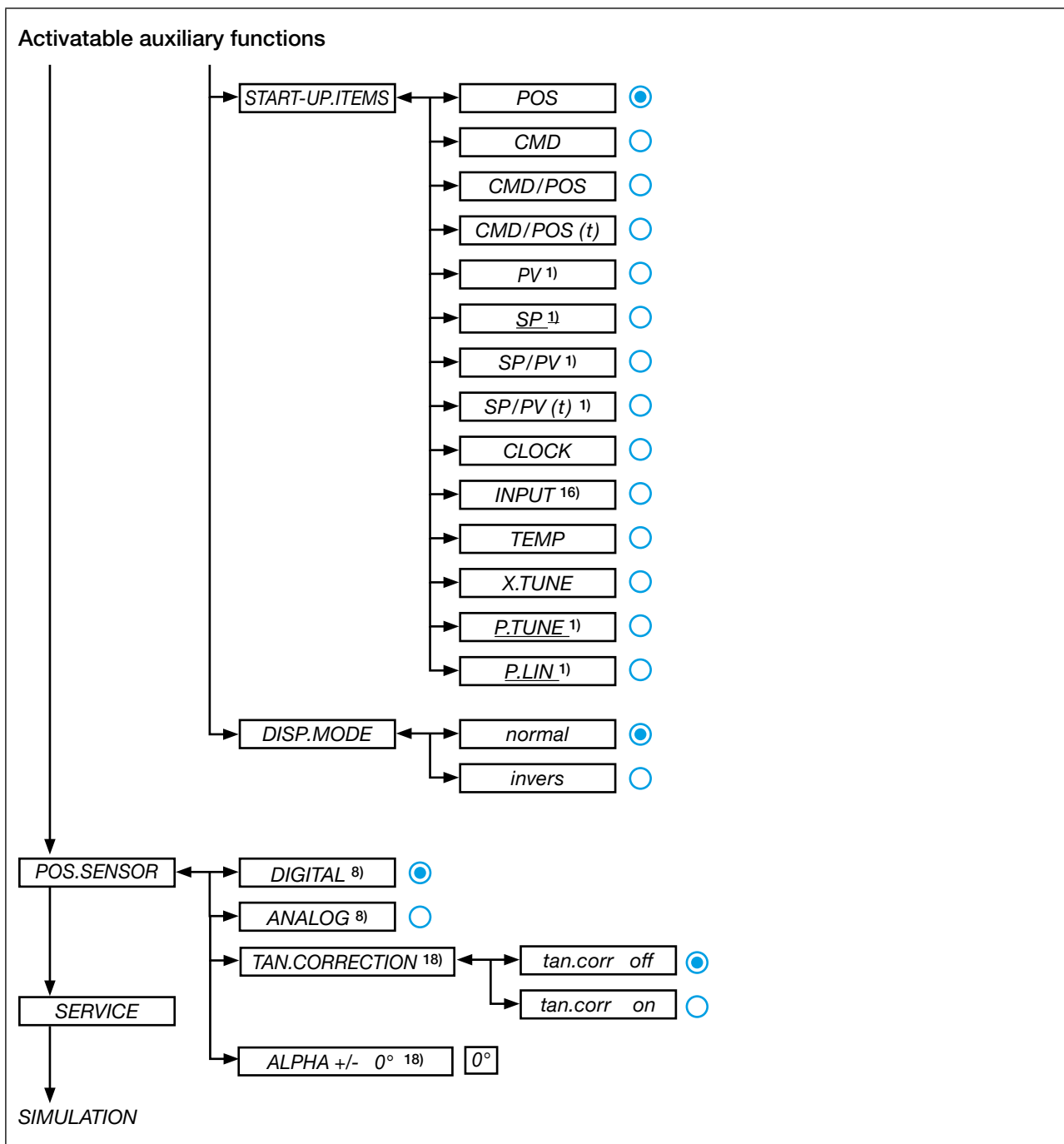


Fig. 109: Operating structure- 10

MAN 1000118577 EN Version: K Status: RL (released | freigegeben) printed: 05.08.2022

1) only process controller Type 8793  
16) nicht bei Feldbus





MAN 1000118577 EN Version: K Status: RL (released | freigegeben) printed: 05.08.2022

Fig. 110: Operating structure - 11

1) only process controller Type 8793  
 8) for Type 8793 Remote onl  
 16) not for field bus  
 18) only NAMUR-version

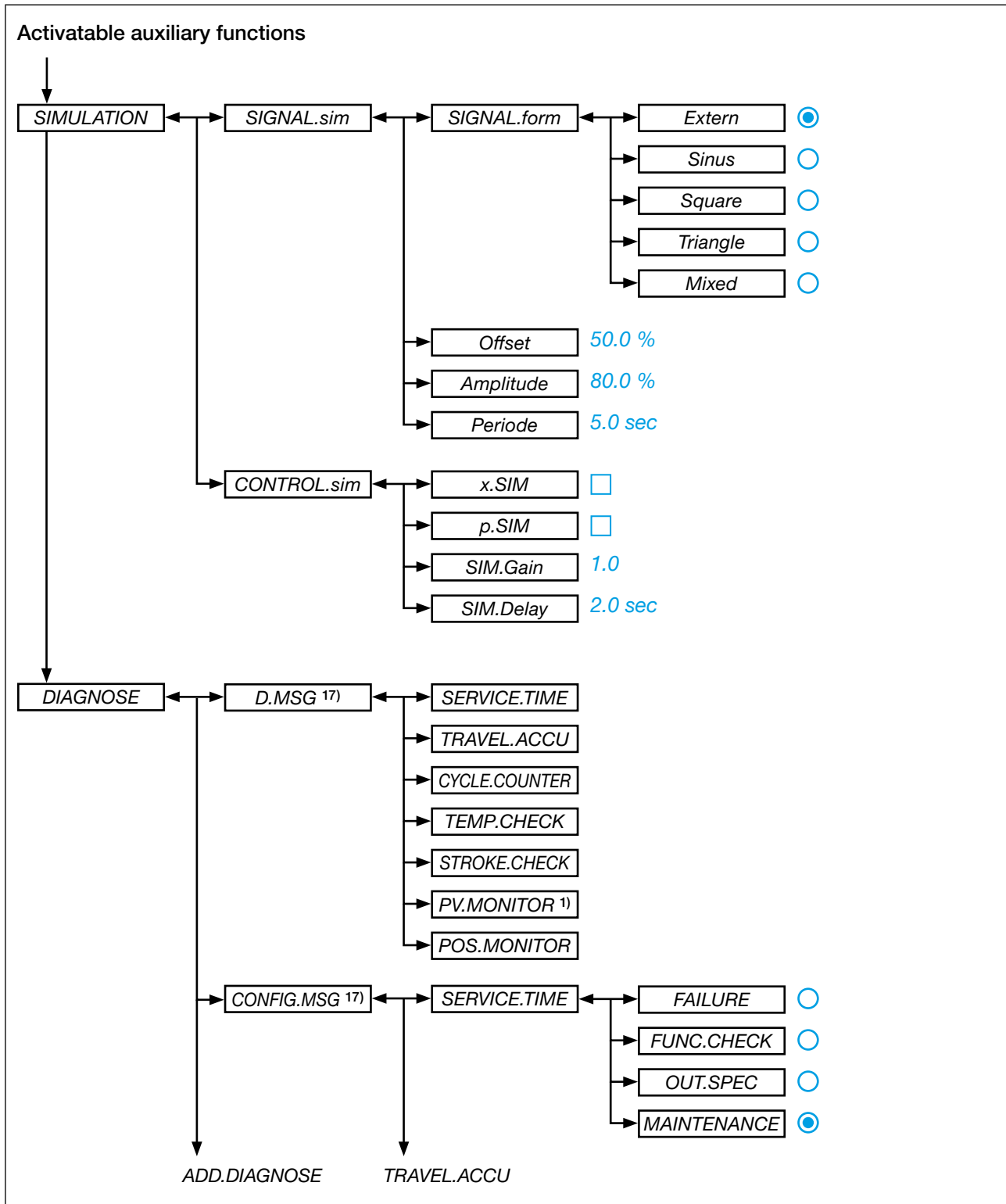


Fig. 111: Operating structure - 12

1) only process controller Type 8793

17) The submenu lists only the activated diagnosis functions

MAN 1000118577 EN Version: K Status: RL (released | freigegeben) printed: 05.08.2022

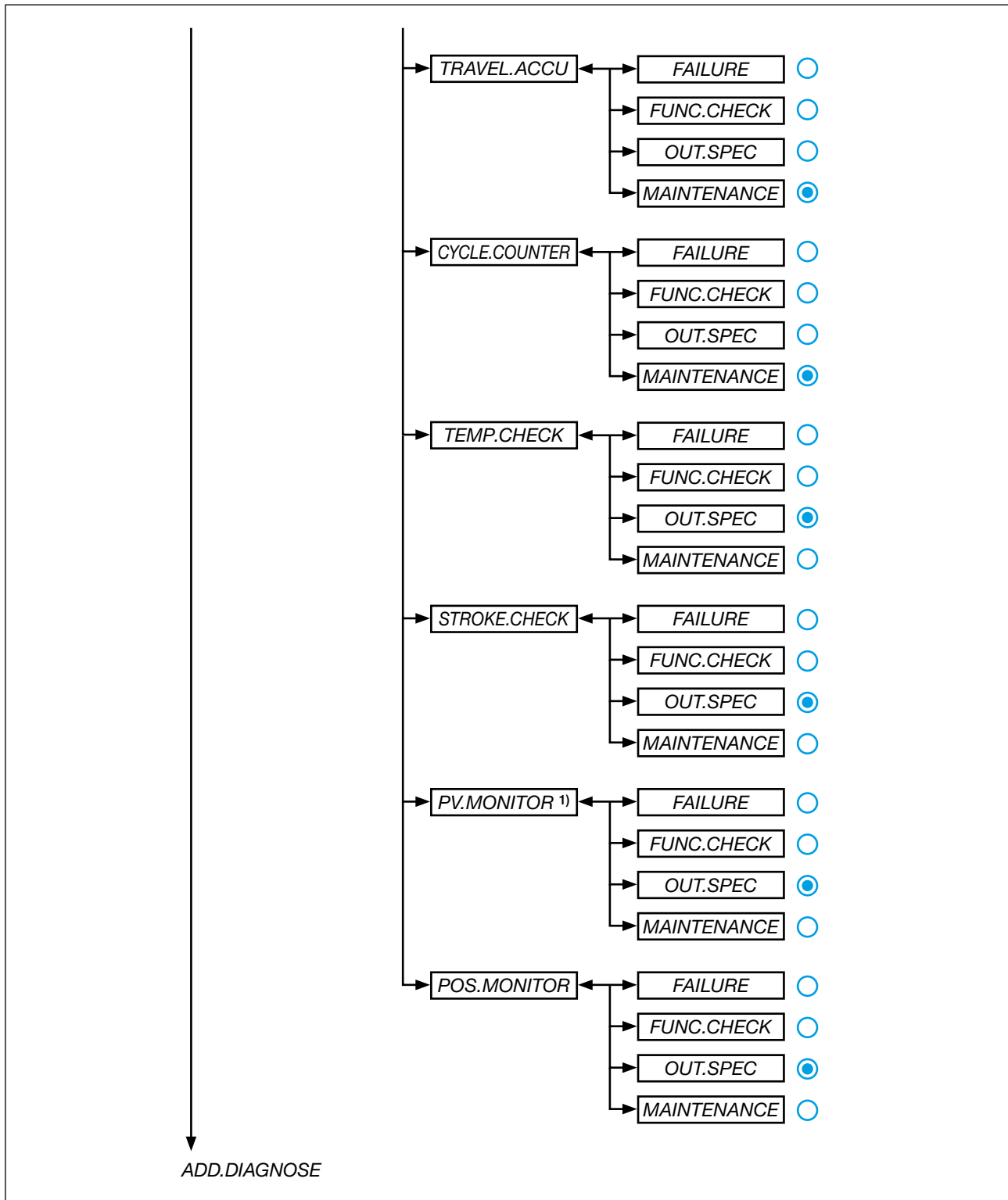


Fig. 112: Operating structure - 13

1) only process controller Type 8793

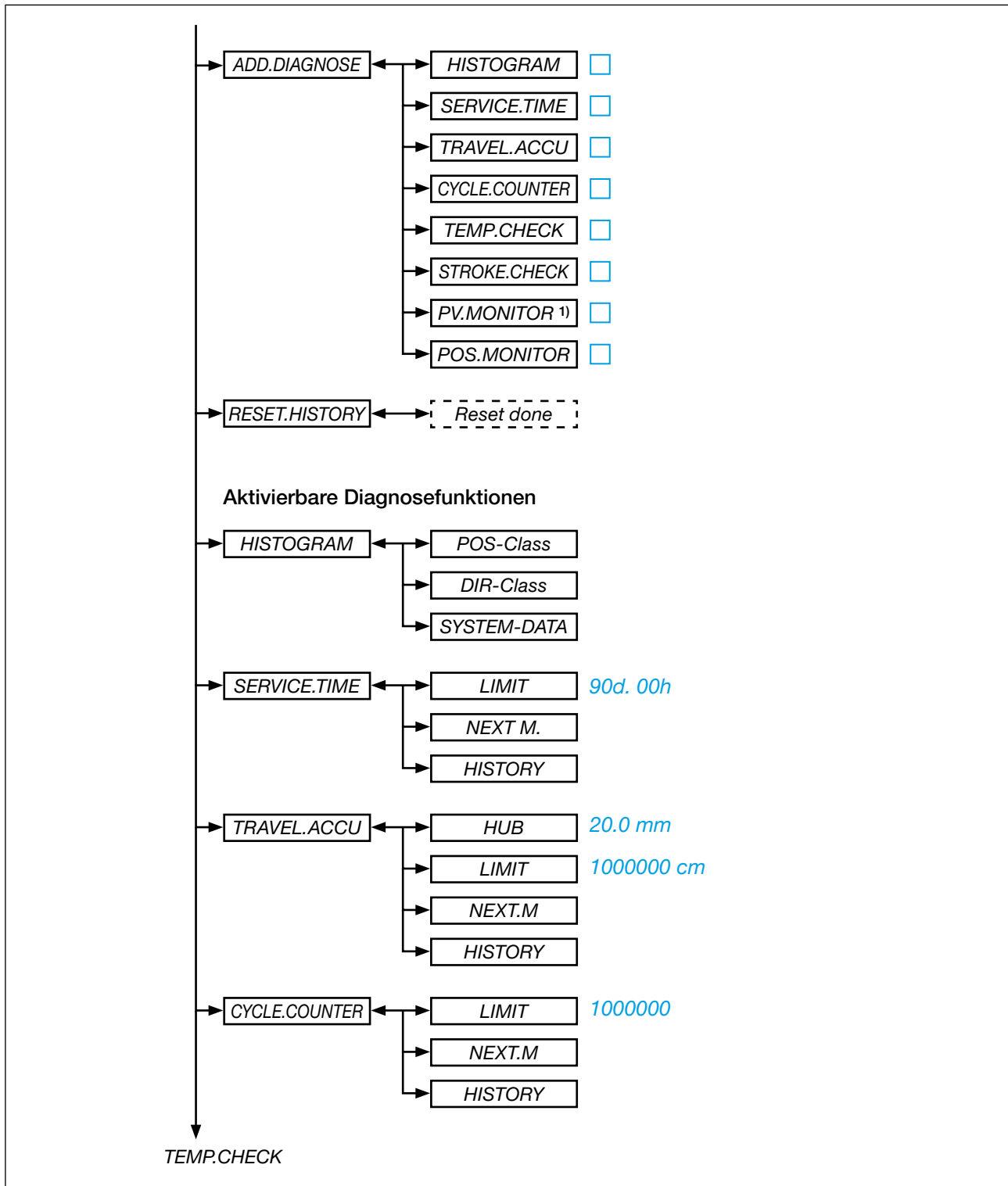


Fig. 113: Operating structure - 14

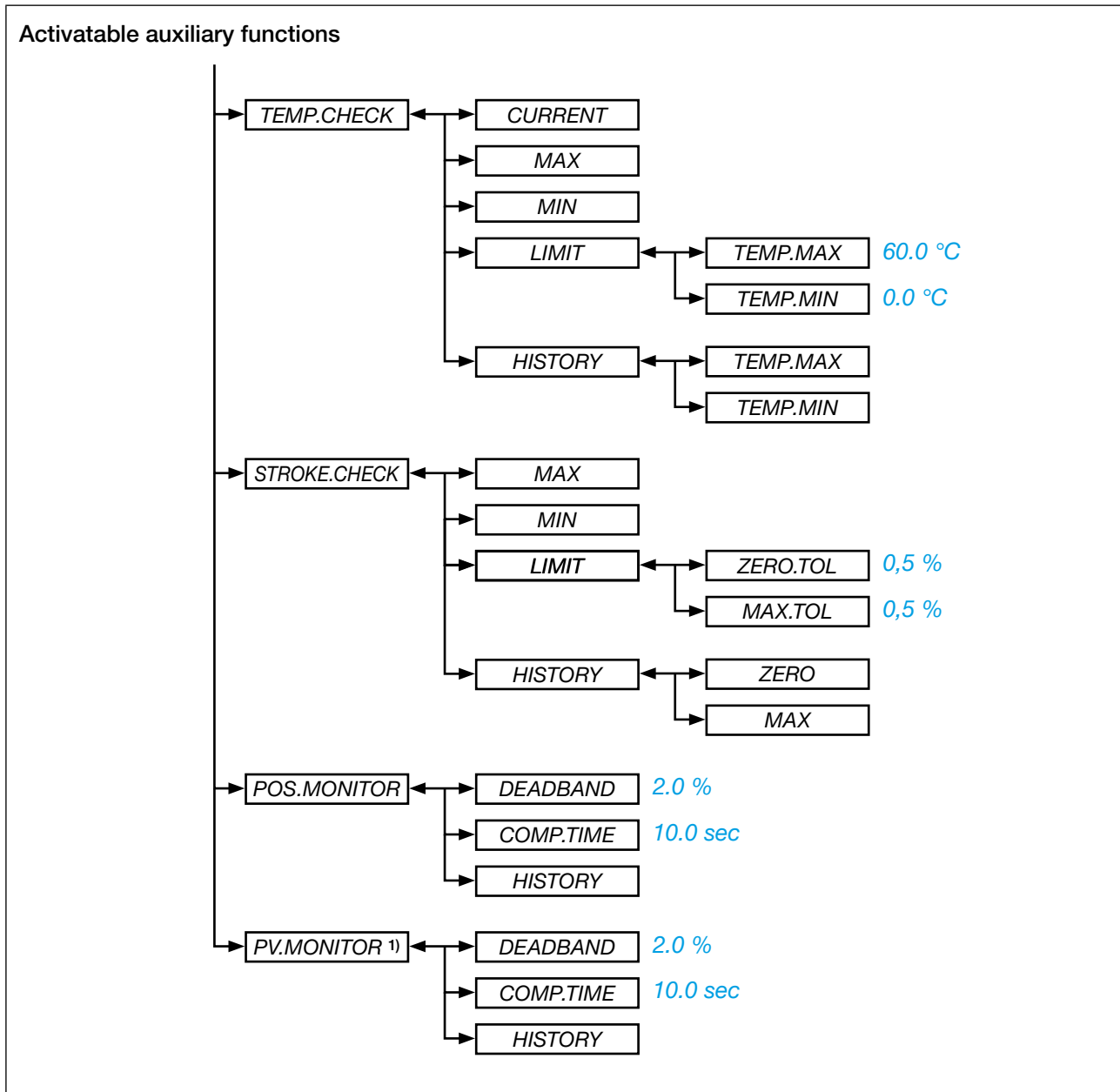


Fig. 114: Operating structure - 15

MAN 1000118577 EN Version: K Status: RL (released | freigegeben) printed: 05.08.2022

1) only process controller Type 8793

## 27 PROFIBUS DP

### 27.1 Technical data

The protocol sequence complies with the standard DIN 19245 Part 3.

GSD file	BUER0C1E.gsd
Bitmap files	BUER0C1E.bmp
PNO-ID	0C1E Hex
Baud rate	Max. 12 mbaud (is automatically set by the Type 8792/8793)
Sync and Freeze mode	Are not supported
Diagnosis telegram	No device-specific diagnosis
Parameter telegram	No user parameters

The process data is configured in the Type 8792/8793 and in the PROFIBUS master.

Maximum 10 process values (total *INPUT* and *OUTPUT*) can be transferred.

### 27.2 Interfaces

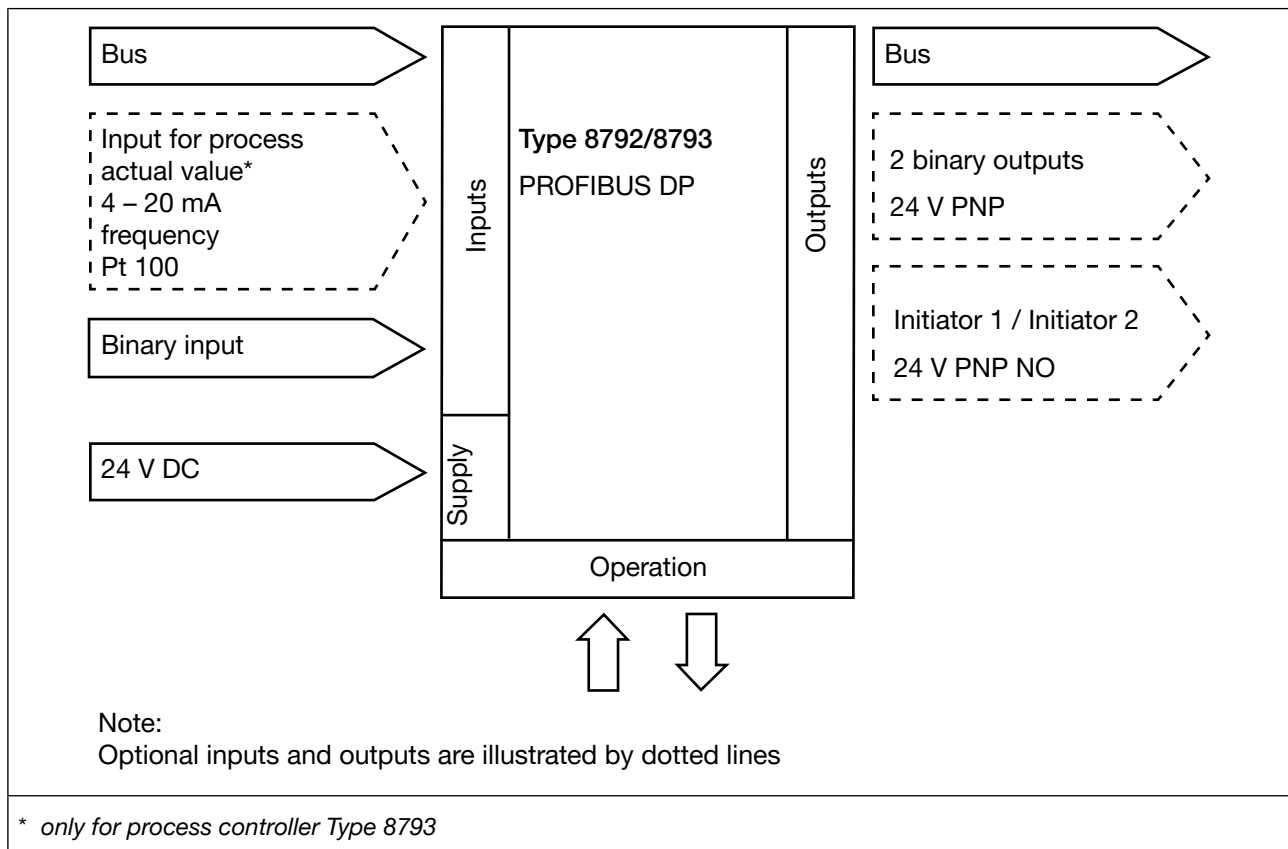


Fig. 115: Interfaces PROFIBUS DP

## 27.3 Changing the operating state

There are two ways of switching between the MANUAL and AUTOMATIC operating states for the PROFIBUS DP:

- Input via the keyboard on the device:  
On the process level using the key function **MANU** and **AUTO**.
- The operating state is transferred to the device via the bus (under *PDO MODE*).  
In this case switching is no longer possible using the keyboard on the device.

## 27.4 Safety settings if the bus fails

The position is approached which corresponds to the set-point value last transferred (default setting).

Other setting options (see chapter [“30.3 BUS.COMM – Settings on Type 8792/8793”](#)).

## 27.5 Bus status display

The bus status is indicated on the display on the device.

Display	Device status	Explanation	Troubleshooting
BUS offline is displayed approx. every 3 seconds	offline	Device is not connected to the bus	<ul style="list-style-type: none"> <li>• Check bus connection including plug assignment.</li> <li>• Check operating voltage and bus connection of the other nodes.</li> </ul>

Table 101: Bus status display; PROFIBUS DP

## 27.6 Differences between the field bus devices and devices without a field bus

The following chapters of these operating instructions are not valid for Type 8792/8793 with PROFIBUS DP.

- Section “Installation”
  - Chapter [“14 Electrical connection - Circular plug-in connector version \(multi-pole version\)”](#)
  - Chapter [“15 Electrical connection - Terminal version for cable gland”](#)
- Section “Start-up”
  - Chapter [“23.1 INPUT - Setting the input signal”](#)
- Section “Auxiliary functions”
  - Chapter [“26.2.5 SPLTRNG – Signal split range”](#)
  - Chapter [“26.2.15 CAL.USER – Calibration of actual value and set-point value”](#)
    - Menu option *calibr.INP*, calibration of the position set-point value
    - Menu option *calibr.SP*, calibration of the process set-point value

## 27.7 Electrical connections

### **DANGER!**

Risk of injury due to electrical shock.

- ▶ Before reaching into the device or the equipment, switch off the operating voltage and secure to prevent reactivation.
- ▶ Observe applicable accident prevention and safety regulations for electrical equipment.

### **WARNING!**

Risk of injury from improper installation.

- ▶ Installation may be carried out by authorized technicians only and with the appropriate tools.

Risk of injury from unintentional activation of the system and an uncontrolled restart.

- ▶ Secure system from unintentional activation.
- ▶ Following installation, ensure a controlled restart.

For operation of the device the following must always be connected:

- **X1** - circular connector M12, 8-pole (for operating voltage see Table [“Table 102: Pin assignment; X1 - M12, 8-pole circular connector; PROFIBUS DP”](#)) and
- **X2** - socket M12, 5-pole, inversely coded (see Table [“Table 103: Pin assignment; X2/X3 - M12, 5-pole circular connector/socket - bus connection, PROFIBUS DP”](#)).

### **NOTE!**

Electromagnetic compatibility (EMC) is only ensured if the appliance is connected correctly to an earthing point.

On the outside of the housing is a TE terminal for connection of the technical earth (TE).

- ▶ Connect the TE terminal to the earthing point via a shortest possible cable (maximum length 30 cm).



### 27.7.1 Connection diagram Type 8792

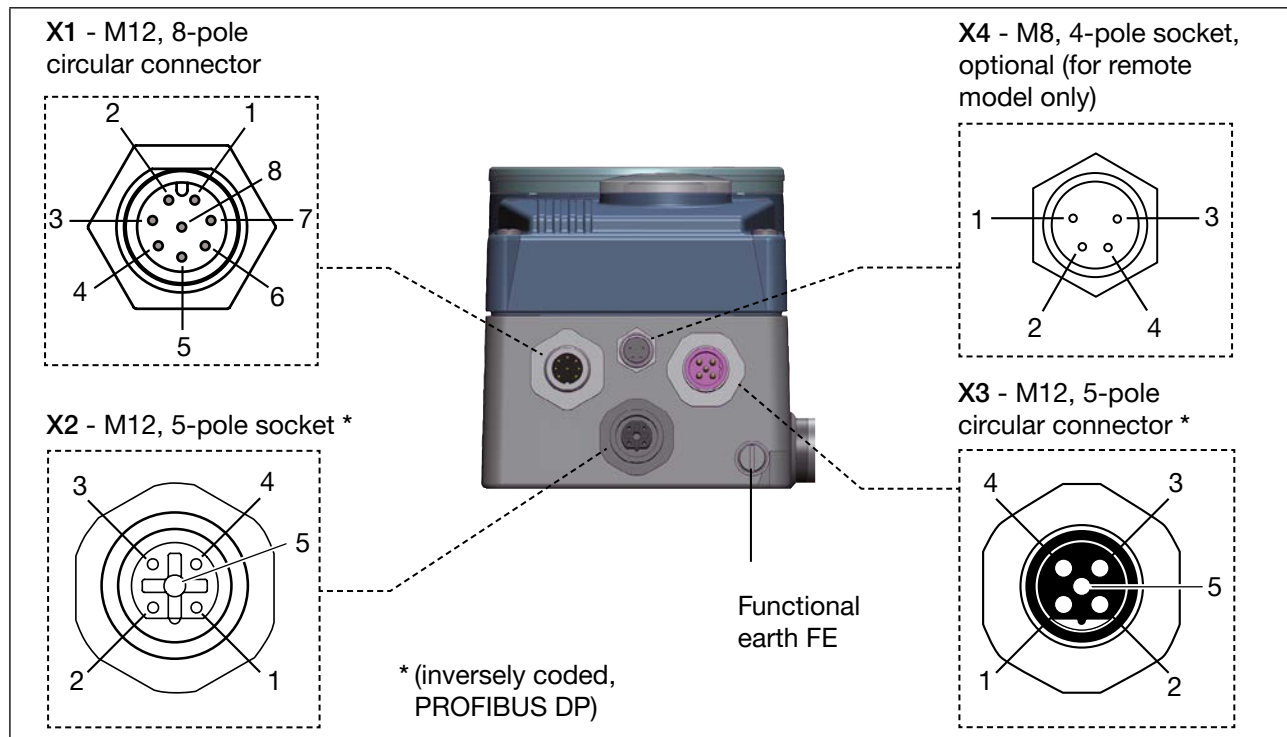


Fig. 116: Connection PROFIBUS DP, positioner Typ 8792

### 27.7.2 Connection diagram Type 8793

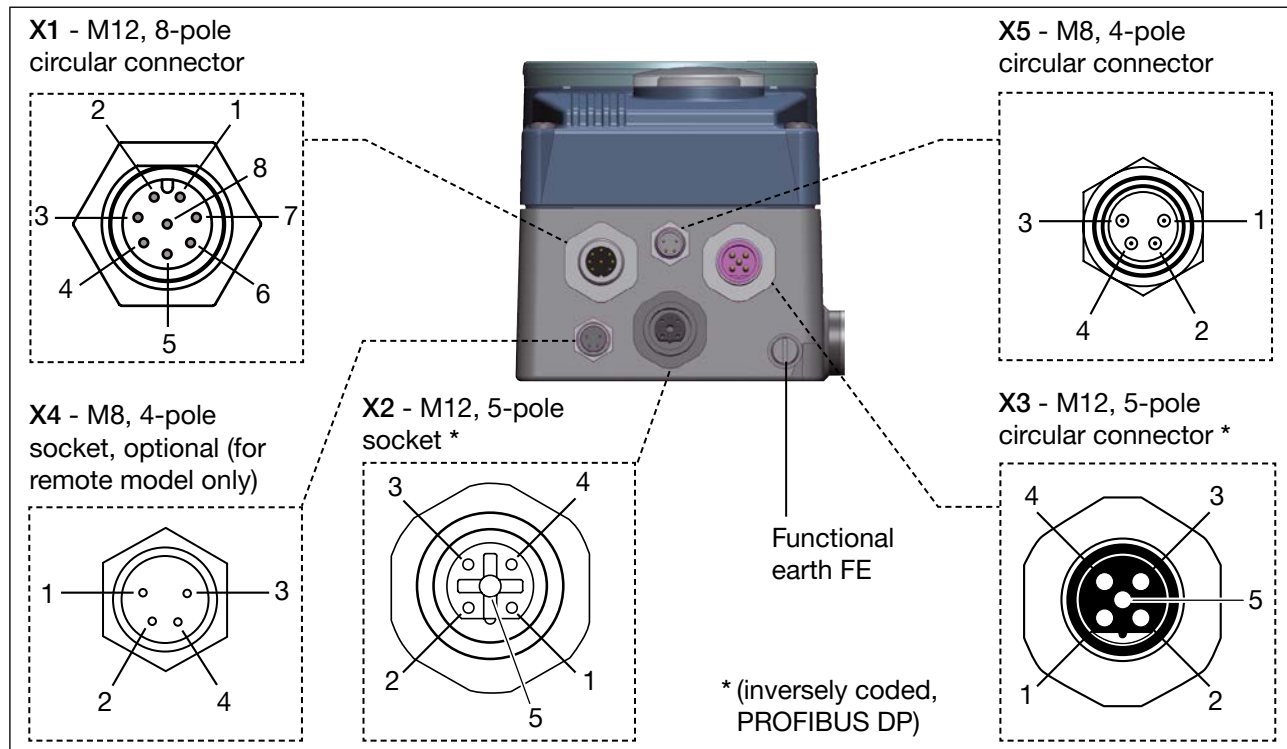


Fig. 117: Connection PROFIBUS DP, process controller Typ 8793

MAN 1000118577 EN Version: K Status: RL (released | freigegeben) printed: 05.08.2022

### 27.7.3 X1 - M12, 8-pole circular connector

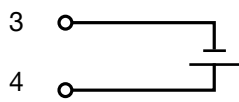
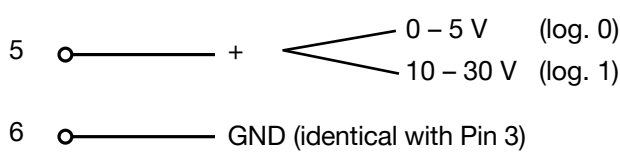
Pin	Configuration	On the device side	External circuit / Signal level
1	not used		
2	not used		
<b>Operating voltage</b>			
3	GND	3	
4	+24 V	4	
<b>Input signals of the control centre (e.g. PLC)</b>			
5	Binary input +	5	
6	Binary input -	6	
<b>Output signals to the control centre (e.g. PLC) - (only used for binary output option)</b>			
7	Binary output 1 (referring to Pin 3)	7	0 – 24 V
8	Binary output 2 (referring to Pin 3)	8	0 – 24 V

Table 102: Pin assignment; X1 - M12, 8-pole circular connector; PROFIBUS DP

### 27.7.4 X2/X3 - M12, 5-pole socket/circular connector - bus connection

Pin	Configuration	External circuit / Signal level
1	VP+5	Supply the terminating resistors
2	RxD/TxD-N	Received/transmitted data -N, A-line
3	DGND	Data transmission potential (earth to 5 V)
4	RxD/TxD-P	Received/transmitted data -P, B-line
5	Shielding	Shielding / protective earth

Table 103: Pin assignment; X2/X3 - M12, 5-pole circular connector/socket - bus connection, PROFIBUS DP

### 27.7.5 X4 - M8, 4-pole socket, optional - Remote Sensor (for remote model only)

Connection of the digital, contact-free position sensor Type 8798:

Pin	Configuration	On the device side	External circuit
1	Supply sensor +	S +	
2	Supply sensor -	S -	
3	Serial interface, A cable	A	
4	Serial interface, B cable	B	

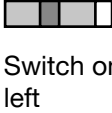
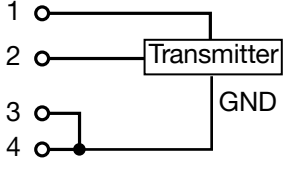
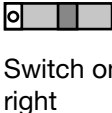
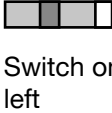
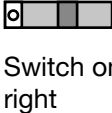
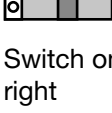
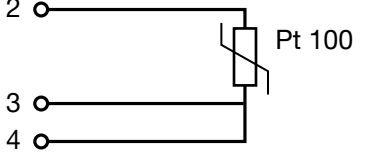
Table 104: Plug assignments; X4 - M8, 4-pole socket - digital, contact-free position sensor Type 8798

Connection of an analog, potentiometric position sensor:

Pin	Configuration	On the device side	External circuit
1	Potentiometer 1	1	
2	Wiper 2	2	
3	Potentiometer 3	3	
4	not used		

Table 105: Plug assignments; X4 - M8, 4-pole socket - analog, potentiometric position sensor

### 27.7.6 X5 - M8, 4-pole circular connector - process actual value (Type 8793 only)

Input type*	Pin	Wire colour **	Configuration	DIP switches***	On the device side	External circuit
4 – 20 mA - internally supplied	1 2 3 4	brown white blue black	+24 V transmitter supply Output from transmitter GND (identical with the GND operating voltage) Bridge after GND (Pin 3)	 Switch on left		
4 – 20 mA - externally supplied	1 2 3 4	brown white blue black	not used Process actual + not used Process actual -	 Switch on right	2 ○ — 4 – 20 mA 4 ○ — GND 4 – 20 mA	
Frequency - internally supplied	1 2 3 4	brown white blue black	+24 V sensor supply Clock input + Clock input - (GND) not used	 Switch on left	1 ○ — +24 V 2 ○ — Clock + 3 ○ — Clock - / GND (identical with the GND operating voltage)	
Frequency - externally supplied	1 2 3 4	brown white blue black	not used Clock input + Clock input - not used	 Switch on right	2 ○ — Clock + 3 ○ — Clock -	
Pt 100 (see information below)	1 2 3 4	brown white blue black	not used Process actual 1 (power supply) Process actual 3 (GND) Process actual 2 (compensation)	 Switch on right		

\* Can be adjusted via software (see chapter “25.2.1 PV-INPUT – Specifying signal type for the process actual value”).  
 \*\* The indicated colors refer to the connection cable available as an accessory (918 718).  
 \*\*\* The switch is inside the device on the PCB (see “Fig. 25: Location of the switch; symbols for switch position”).

Table 106: Plug assignments; X5 - M8, 4-pole circular connector - process actual value input; PROFIBUS DP



Connect the Pt 100 sensor via 3 cables for cable compensation reasons. It is essential to bridge Pin 3 and Pin 4 on the sensor.

## 27.8 Start-up PROFIBUS DP

### 27.8.1 Safety instructions



#### WARNING!

Risk of injury from improper operation.

Improper operation may result in injuries as well as damage to the device and the area around it

- ▶ Before start-up, ensure that the operating personnel are familiar with and completely understand the contents of the operating instructions.
- ▶ Observe the safety instructions and intended use.
- ▶ Only adequately trained personnel may start up the equipment/the device.



Before start-up, carry out fluid installation (see Chapter “13”) and electrical installation (Chapter “29”) of Type 8792/8793 and of the valve.

### 27.8.2 Start-up sequence

For start-up of Type 8792/8793 PROFIBUS DP the following basic settings are required:

Device type	Sequence	Type of basic setting	Setting via	Description in chapter
8792 and 8793	1	Adjust device to the local conditions	<i>X.TUNE</i>	“23.2”
For 8793 only (Process control)	2	Activate process controller.	<i>ADD.FUNCTION</i>	“24”
8792 and 8793	3	Settings on Type 8792/8793: Input device address.	<i>BUS.COMM</i>	“30.3”
	4	Activate or deactivate safety position.		
8792 and 8793	5	Configuration via the control (PROFIBUS DP Master): Configuration of the process values 1. <i>PDI</i> : Process data input 2. <i>PDO</i> : Process data output.	PROFIBUS DP Master by means of GSD file and special software	“30.4”

Table 107: Start-up sequence for PROFIBUS DP

### 27.8.3 BUS.COMM – Settings on Type 8792/8793

Set the following menu options in the *BUS.COMM* menu for start-up of the PROFIBUS DP:

**Address 0** Enter a device address (value between 0 and 126)

**BUS FAIL** Activate or deactivate approach of the safety position

Selection **SafePos off**  – The actuator remains in the position which corresponds to the set-point value last transferred (default setting).

Selection **SafePos on**  – If there is a fault in the bus communication, the behavior of the actuator depends on the activation of the *SAFEPOS* auxiliary function. See Chapter [“26.2.11 SAFEPOS – Input the safety position”](#).

*SAFEPOS* activated: The actuator moves to the safety position which is specified in the *SAFEPOS* auxiliary function.

*SAFEPOS* deactivated: The actuator moves to the safety end position which it would assume if the electrical and pneumatic auxiliary power failed. See Chapter [“10.9 Safety end positions after failure of the electrical or pneumatic auxiliary power”](#).

**Procedure:**










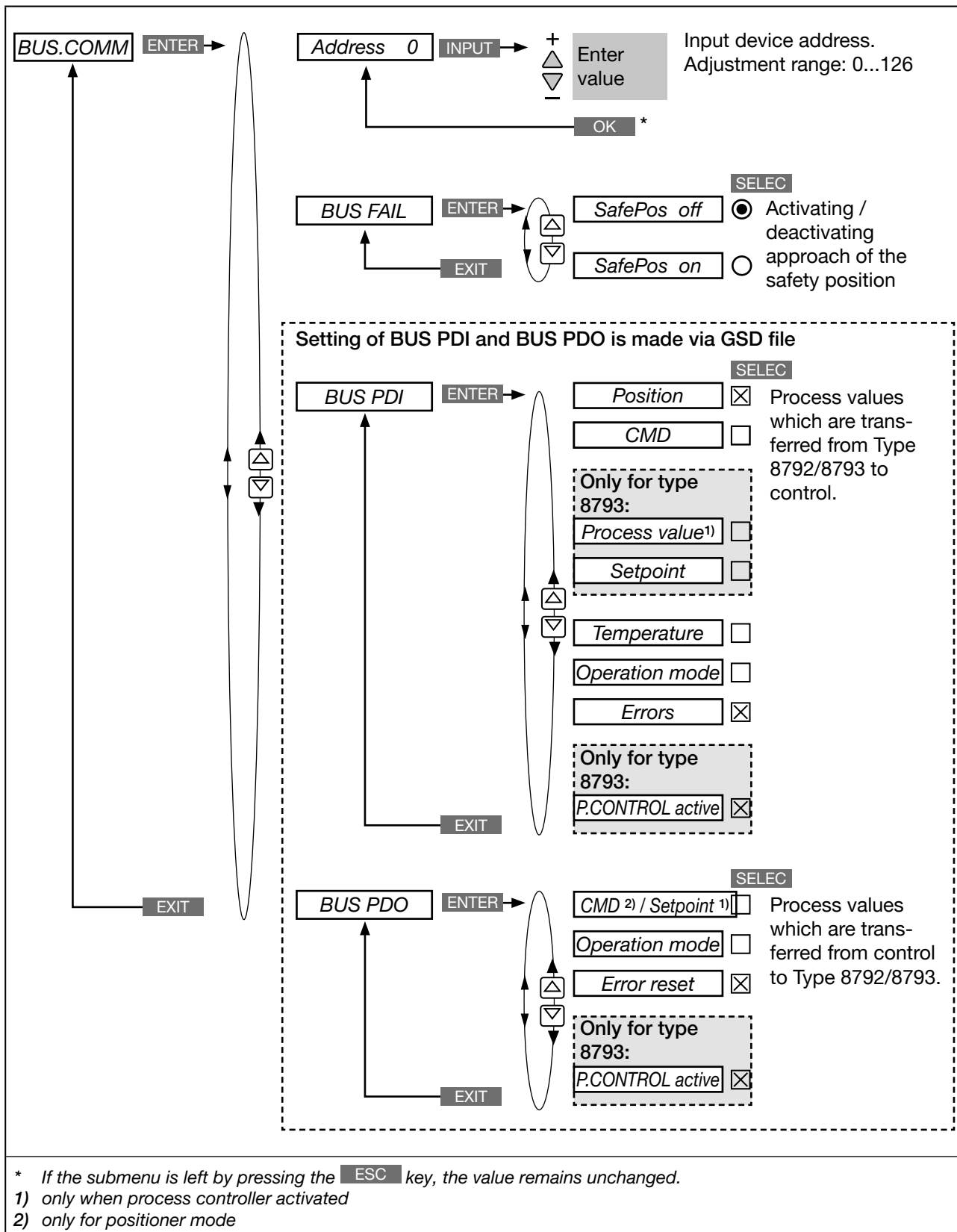
Key	Action	Description
<b>MENU</b>	Press  for approx. 3 s	Switching from process level ⇒ setting level.
<b>▲ / ▼</b>	Select <i>BUS.COMM</i>	Selection in the main menu (MAIN).
<b>ENTER</b>	Press 	The submenu options for basic settings can now be selected.
<b>Setting device address</b>		
<b>▲ / ▼</b>	Select <i>Address</i>	
<b>INPUT</b>	Press 	The input screen is opened.
<b>▲ / ▼</b>	<b>+</b> Increase value <b>-</b> Reduce value	Enter a device address (value between 0 and 126).
<b>OK</b>	Press 	Return to <i>BUS.COMM</i> .
<b>Deactivating / activating safety position</b>		
<b>▲ / ▼</b>	Select <i>BUS FAIL</i>	
<b>ENTER</b>	Press 	The menu options for deactivating and activating the safety position are displayed.
<b>▲ / ▼</b>	Select menu option	<b>SafePos off</b> = deactivated <b>SafePos on</b> = activated
<b>SELEC</b>	Press 	The selection is now marked by a filled circle <input checked="" type="radio"/> .
<b>EXIT</b>	Press 	Return to <i>BUS.COMM</i> .
<b>EXIT</b>	Press 	Return to the main menu (MAIN).
<b>EXIT</b>	Press 	Switching from setting level ⇒ process level.

Table 108: *BUS.COMM*; settings

MAN 1000118577 EN Version: K Status: RL (released | freigegeben) printed: 05.08.2022



\* If the submenu is left by pressing the **ESC** key, the value remains unchanged.  
 1) only when process controller activated  
 2) only for positioner mode

Fig. 118: Operating structure - BUS.COMM; PROFIBUS DP

## 27.9 Configuration via the control (PROFIBUS DP Master)

The configuration requires the following components:

- Software suitable for the configuration. For example Step7 from Siemens A brief description of this can be found in the following chapter [“30.5 Configuration with Siemens Step7”](#).
- GSD file (download from the Bürkert homepage:)

### 27.9.1 Supplementary literature on the configuration of the PROFIBUS DP

More detailed information can be found in the supplementary instructions on the Bürkert homepage:

- „Configuration on the PROFIBUS by means of GSD file“  
www.burkert.com → Type 8792 or Type 8793 → Config. PROFIBUS by GSD-file

### 27.9.2 Configuration of the process values

→ The PDI (Process Data Input) input first.

*PDI: Process Data Input* (from the Type 8792/8793 to the controller)

Name	Description	Identifier
<i>PDI:POS</i>	Actual position (position)  Actual value of positioner as ‰. Value range 0 – 1000. Values < 0 or > 1000 are possible if e.g. Autotune has not run through correctly.	GSD file: <i>PDI:POS</i>  Identifier (HEX): 41, 40, 00
<i>PDI:CMD</i>	Nominal position (command)  Set-point value of positioner as ‰. Value range 0 – 1000.	GSD file: <i>PDI:CMD</i>  Identifier (HEX): 41, 40, 01
<i>PDI:PV</i>  <i>PDI:SP</i>	Process actual value (process value)  Actual value of process controller in physical unit (as set in the menu <i>P.CONTROL</i> → <i>SETUP</i> → <i>PV-INPUT</i> or <i>PV-SCALE</i> ), max. value range -999 – 9999, depending on internal scaling  Process set-point value (setpoint)  Set-point value of process controller in physical unit (as set in the menu <i>P.CONTROL</i> → <i>SETUP</i> → <i>SP-INPUT</i> or <i>SP-SCALE</i> ), max. value range -999 – 9999, depending on internal scaling	GSD file: <i>PDI:PV</i>  Identifier (HEX): 41, 40, 02  GSD file: <i>PDI:SP</i>  Identifier (HEX): 41, 40, 03
<i>PDI:TEMP</i>	Device temperature (temperature)  Temperature of 0.1 °C is measured on the CPU board by the sensor,  Value range -550 (-55 °C) – +1250 (+125 °C)	GSD file: <i>PDI:TEMP</i>  Identifier (HEX): 41, 40, 04



Name	Description	Identifier
<i>PDI:MODE</i>	Operating state (operation mode) Operating state: 0: <i>AUTO</i> 1: <i>MANU</i> 2: <i>XTUNE</i> 9: <i>P.QLIN</i> 10: <i>P.TUNE</i> 12: <i>BUSSAFEPOS</i>	GSD file: <i>PDI:MODE</i>  Identifier (HEX): 41, 00, 05
<i>PDI:ERR</i>	Error Indicates the number of the process value (output) which was not written. The value is retained until it is deleted with <i>PDO:ERR</i> . HEX 14 <i>PDO:CMD / SP</i> 16 <i>PDO:MODE</i>	GSD file: <i>PDI:ERR</i>  Identifier (HEX): 41, 00, 06
<i>PDI:PCONact</i>	0: Positioner 1: Process controller	GSD file: <i>PDI:PCONact</i> Identifier (HEX): 41, 00, 0A

Table 109: Process Data Input, PROFIBUS DP



*PDI:PV* and *PDI:SP* can be selected for Type 8793 (process controller) only and are beneficial only when process controller activated.

*PDI:PCONact* can be selected for Type 8793 (process controller) only.

→ Then the PDO (Process Data Output) input.

**PDO: Process Data Output** (from the controller to the Type 8792/8793)

Name	Description	Identifier
<i>PDO:CMD/SP</i>	<p>for positioner Type 8792: Set-point position (input)</p> <p>Set-point value of positioner as %. Value range 0 – 1000 If the value is too small or too large, the last valid value is used and is indicated in <i>ERR</i> with HEX 14.</p> <p>for process controller Type 8793: Process set-point value (setpoint)</p> <p>Set-point value of process controller in physical unit (as set in the menu <i>P.CONTROL</i> → <i>SETUP</i> → <i>SP-INPUT</i> or <i>SP-SCALE</i>), max. value range -999 – 9999, depending on internal scaling.</p> <p>If the value is too small or too large, the last valid value is used and is indicated in <i>ERR</i> with HEX 14.</p>	<p>GSD file: <i>PDO:CMD/SP</i></p> <p>Identifier (HEX): 81, 40, 14</p>
<i>PDO:MODE</i>	<p>Operating state (operation mode)</p> <p>Value range 0, 1 or 12:</p> <p>0: <i>AUTO</i> / 1: <i>MANU</i> / 12: <i>BUSSAFEPOS</i></p> <p>If the value is too small or too large, the last valid value is used and is indicated in <i>ERR</i> with HEX 16.</p>	<p>GSD file: <i>PDO:MODE</i></p> <p>Identifier (HEX): 81, 00, 16</p>
<i>PDO:ERR</i>	<p>Reset error display</p> <p>If the value &gt; 0, <i>ERR</i> is reset</p>	<p>GSD file: <i>PDO:ERR</i></p> <p>Identifier (HEX): 81, 00, 17</p>
<i>PDO:CONact</i>	<p>0: Positioner</p> <p>1: Process controller</p>	<p>GSD file: <i>PDO:CONact</i></p> <p>Identifier (HEX): 81, 00, 19</p>

Table 110: Process Data Output, PROFIBUS DP

## 27.10 Configuration with Siemens Step7

### 27.10.1 Example 1 of a positioner (Type 8792): Transfer of set-point and actual value

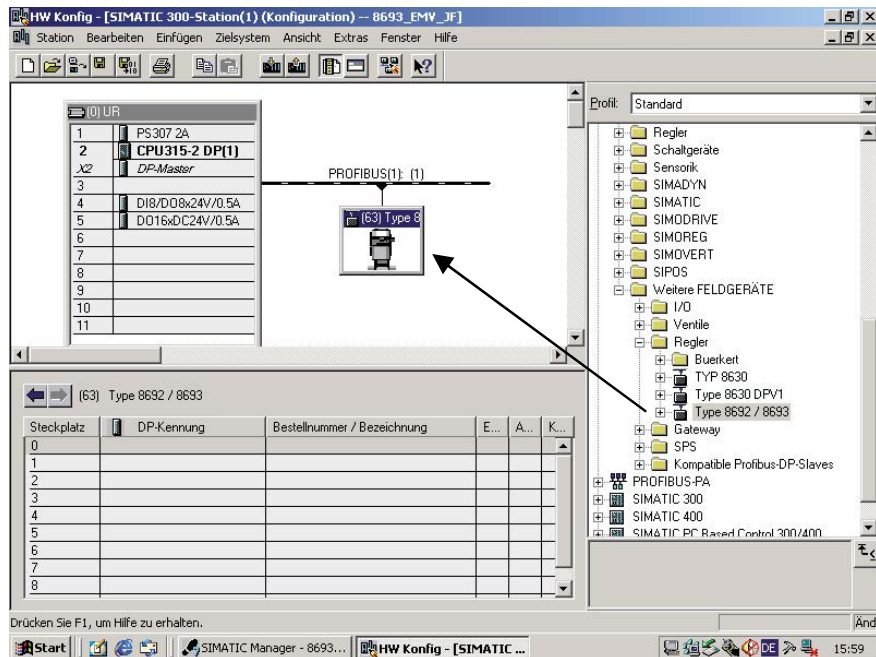


Fig. 119: ScreenShot PROFIBUS

→ Pull the slave Type 8792 / 8793 onto the bus line with drag-and-drop.

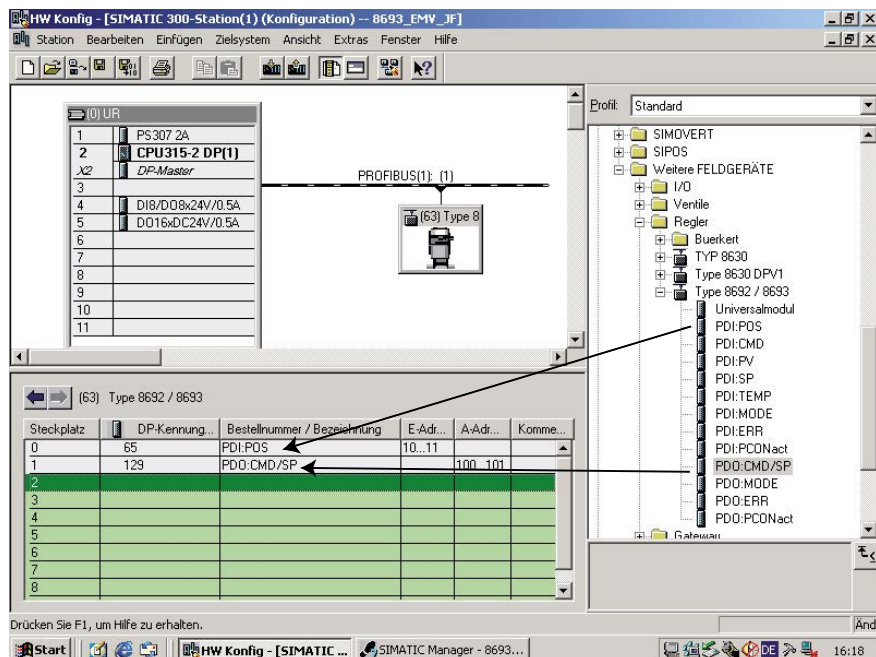


Fig. 120: ScreenShot positioner

→ Pull the modules PDI:POS and PDO:CMD/SP into the slave Type 8792 / 8793 with drag-and-drop.

## 27.10.2 Example 2 of a process controller (Type 8793): Transfer of several process values

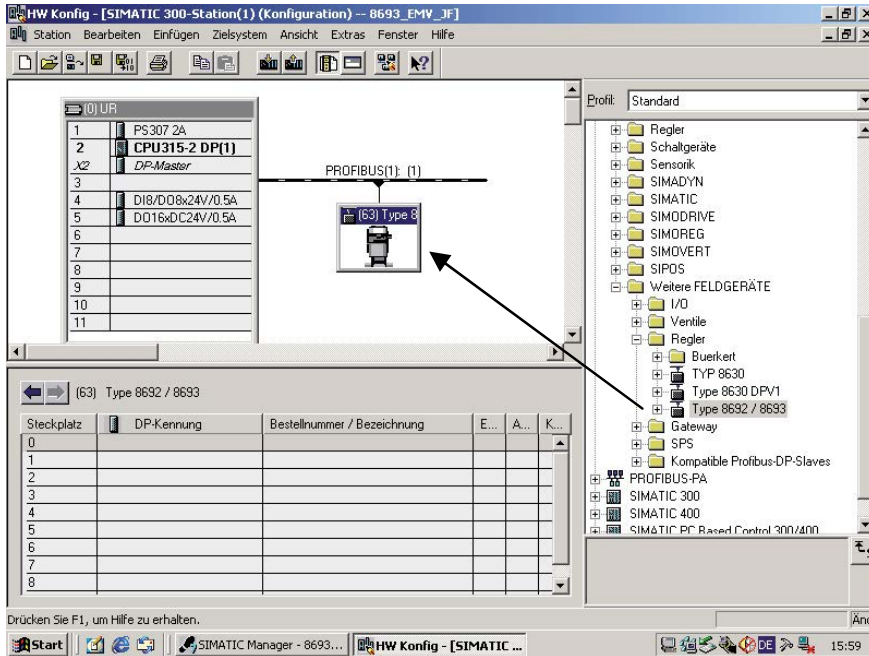


Fig. 121: ScreenShot PROFIBUS

→ Pull the slave Type 8792 / 8793 onto the bus line with drag-and-drop.

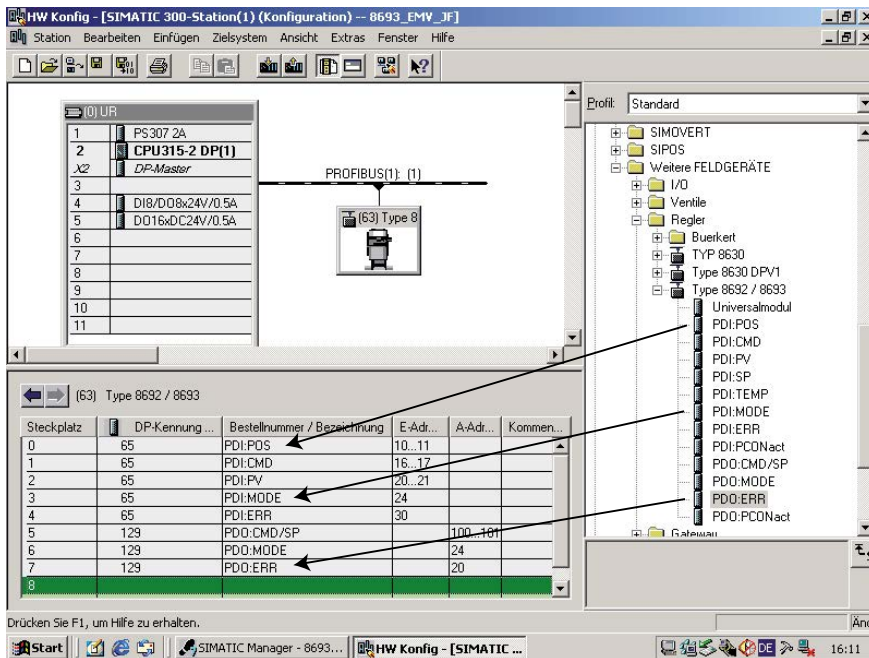


Fig. 122: ScreenShot process controller

→ Pull the modules into the slave Type 8792 / 8793 with drag-and-drop.

## 28 MAINTENANCE

The Type 8792/8793 is maintenance-free when operated according to the instructions in this manual.

## 29 ERROR MESSAGES AND MALFUNCTIONS

### 29.1 Error messages on the display

#### 29.1.1 General error messages



Display	Causes of error	Remedial action
	Minimum input value has been reached	Do not reduce value further
	Maximum input value has been reached	Do not increase value further
<i>CMD error</i>	Signal error Set-point value positioner (positioner)	Check signal
<i>SP error</i>	Signal error Set-point value process controller	Check signal
<i>PV error</i>	Signal error Actual value process controller	Check signal
<i>PT100 error</i>	Signal error Actual value Pt-100	Check signal
<i>invalid Code</i>	Incorrect access code	Input correct access code
<i>EEPROM fault</i>	EEPROM defective	Not possible, device defective

Table 111: General error message

## 29.1.2 Error and warning messages while the X.TUNE function is running

Display	Causes of error	Remedial action
TUNE err/break	Manual termination of self-parameterization by pressing the <b>EXIT</b> key	
X.TUNE locked	The X.TUNE function is blocked	Input access code
X.TUNE ERROR 1	No compressed air connected	Connect compressed air
X.TUNE ERROR 2	Compressed air failed during Autotune (X.TUNE).	Check compressed air supply
X.TUNE ERROR 3	Actuator or control system deaeration side leaking	Not possible, device defective
X.TUNE ERROR 4	Control system aeration side leaking	Not possible, device defective
X.TUNE ERROR 5	The rotational range of the position sensor is exceeded by 150°	Correct attachment of the position sensor shaft on the actuator (see chapter "12.2" and "12.3").
X.TUNE ERROR 6	The end positions for POS-MIN and POS-MAX are too close together	Check compressed air supply
X.TUNE ERROR 7	Incorrect assignment POS-MIN and POS-MAX	To determine POS-MIN and POS-MAX, move the actuator in the direction indicated on the display.
X.TUNE WARNING 1**	Potentiometer is not coupled optimally to the actuator.  An optimum connection can provide a more accurate position measurement	Set middle position as described in chapter "12.2.4 Aligning lever mechanism".
** Warning information gives tips on optimized operation. The device is operational even if this warning information is not observed. Warning information is automatically hidden after several seconds.		

Table 112: Error and warning message on X.TUNE

### 29.1.3 Error messages while the *P.Q'LIN* function is running

Display	Cause of fault	Remedial action
<i>Q.LIN</i> <i>err/break</i>	Manual termination of linearization by pressing the <b>EXIT</b> key.	
<i>P.Q'LIN</i> <i>ERROR 1</i>	No supply pressure connected.	Connect supply pressure.
	No change to process variable.	Check process and, if required, switch on pump or open the shut-off valve. Check process sensor.
<i>P.Q'LIN</i> <i>ERROR 2</i>	Failure of the supply pressure while <i>P.Q'LIN</i> running.	Check supply pressure.
	Automatic adjustment of the <i>X.TUNE</i> positioner not run.	Run <i>X.TUNE</i> .

Table 113: Error message on *P.Q'LIN*; process controller Type 8793

### 29.1.4 Error messages while the *P.TUNE* function is running

Display	Cause of fault	Remedial action
<i>TUNE</i> <i>err/break</i>	Manual termination of self-optimization by pressing the <b>EXIT</b> key.	
<i>P.TUNE</i> <i>ERROR 1</i>	No supply pressure connected.	Connect supply pressure.
	No change to process variable.	Check process and, if required, switch on pump or open the shut-off valve. Check process sensor.

Table 114: Error message on *P.TUNE*; process controller Type 8793

### 29.1.5 Error Messages on Field Bus Devices

Display	Causes of error	Remedial action
<i>MFI fault</i>	Field bus board defective.	Not possible, device defective.

Table 115: Error Messages on Field Bus Devices

#### On PROFIBUS:

Display	Device status	Explanation	Troubleshooting
<b>BUS offline</b> is displayed approx. every 3 seconds	Offline.	Device is not connected to the bus.	<ul style="list-style-type: none"> <li>• Check bus connection including plug assignment.</li> <li>• Check operating voltage and bus connection of the other nodes.</li> </ul>

Table 116: Error message PROFIBUS

## 29.2 Other faults

Problem	Possible causes	Remedial action
<p><math>POS = 0</math> (when <math>CMD &gt; 0\%</math>) or <math>POS = 100\%</math>, (when <math>CMD &lt; 100\%</math>)</p> <p><math>PV = 0</math> (when <math>SP &gt; 0</math>) or <math>PV = PV</math> (when <math>SP &gt; SP</math>)</p>	Sealing function ( <i>CUTOFF</i> ) has been unintentionally activated	Deactivate sealing function.
<p><b>Applies only to devices with binary output:</b></p> <p>Binary output does not switch.</p>	<p>Binary output:</p> <ul style="list-style-type: none"> <li>• Current &gt; 100 mA</li> <li>• Short-circuit</li> </ul>	Check binary output connection.
<p><b>Applies only to devices with process controller:</b></p> <p>Device is not operating as a controller, despite correctly implemented settings.</p>	<i>P.CONTROL</i> menu option is in the main menu. The device is therefore operating as a process controller and expects a process actual value at the corresponding input.	Remove <i>P.CONTROL</i> menu option from the main menu. See chapter <a href="#">“19.1.2 Deactivating auxiliary functions”</a> .

Table 117: Other faults



## 30 PACKAGING AND TRANSPORT

### NOTE!

Transport damages.

Inadequately protected equipment may be damaged during transport.

- ▶ During transportation protect the device against wet and dirt in shock-resistant packaging.
- ▶ Avoid exceeding or dropping below the allowable storage temperature.

## 31 STORAGE

### NOTE!

Incorrect storage may damage the device.

- ▶ Store the device in a dry and dust-free location.
- ▶ Storage temperature -20 – +65 °C.

## 32 DISPOSAL

→ Dispose of the device and packaging in an environmentally friendly manner.

### NOTE!

Damage to the environment caused by device components contaminated with media.

- ▶ Observe applicable disposal regulations and environmental regulations.



Observe national waste disposal regulations.

## 33 SELECTION CRITERIA FOR CONTINUOUS VALVES

The following criteria are crucial for optimum control behavior and to ensure that the required maximum flow is reached:

- the correct selection of the flow coefficient which is defined primarily by the orifice of the valve;
- close coordination between the nominal width of the valve and the pressure conditions in consideration of the remaining flow resistance in the equipment.

Design guidelines can be given on the basis of the flow coefficient ( $k_v$  value). The  $k_v$  value refers to standardised conditions with respect to pressure, temperature and media properties.

The  $k_v$  value describes the flow rate of water through a component in  $m^3/h$  at a pressure difference of  $\Delta p = 1$  bar and  $T = 20$  °C.

The “ $k_{vs}$  value” is also used for continuous valves. This indicates the  $k_v$  value when the continuous valve is fully open.

Depending on the specified data, it is necessary to differentiate between the two following cases when selecting the valve:

- a) The pressure values  $p_1$  and  $p_2$ , known before and after the valve, represent the required maximum flow-rate  $Q_{max}$  which is to be reached:

The required  $k_{vs}$  value is calculated as follows:

$$k_{vs} = Q_{max} \cdot \sqrt{\frac{\Delta p_0}{\Delta p}} \cdot \sqrt{\frac{\rho}{\rho_0}} \quad (1)$$

Meaning of the symbols:

- $k_{vs}$  flow coefficient of the continuous valve when fully open [ $m^3/h$ ]
- $Q_{max}$  maximum volume flow rate [ $m^3/h$ ]
- $\Delta p_0 = 1$  bar; pressure loss on the valve according to the definition of the  $k_v$  value
- $\rho_0 = 1000$   $kg/m^3$ ; density of water (according to the definition of the  $k_v$  value)
- $\Delta p$  pressure loss on the valve [bar]
- $\rho$  density of the medium [ $kg/m^3$ ]

- b) The pressure values, known at the input and output of the entire equipment ( $p_1$  and  $p_2$ ), represent the required maximum flow-rate  $Q_{max}$  which is to be reached:

- 1st step: Calculate the flow coefficient of the entire equipment  $k_{vges}$  according to equation (1).
- 2nd step: Determine the flow-rate through the equipment without the continuous valve (e.g. by “short-circuiting” the line at the installation location of the continuous valve).
- 3rd step: Calculate the flow coefficient of the equipment without the continuous valve ( $k_{va}$ ) according to equation (1).
- 4th step: Calculate the required  $k_{vs}$  value of the continuous valve according to equation (2):

$$k_{vs} = \sqrt{\frac{1}{\frac{1}{k_{vges}^2} - \frac{1}{k_{va}^2}}} \quad (2)$$



The  $k_{vs}$  value of the continuous valve should have at least the value which is calculated according to equation (1) or (2) which is appropriate to the application, however it should never be far above the calculated value.

The rule of thumb "slightly higher is never harmful" often used for switching valves may greatly impair the control behavior of continuous valves!

The upper limit for the  $k_{vs}$  value of the continuous valve can be specified in practice via the so-called valve authority  $\Psi$ :

$$\Psi = \frac{(\Delta p)_{vo}}{(\Delta p)_o} = \frac{k_{va}^2}{k_{va}^2 + k_{vs}^2} \quad (3)$$

$(\Delta p)_{vo}$  Pressure drop over the fully opened valve

$(\Delta p)_o$  Pressure drop over the entire equipment



**If the valve authority  $\Psi < 0.3$  the continuous valve has been oversized.**

When the continuous valve is fully open, the flow resistance in this case is significantly less than the flow resistance of the remaining fluid components in the equipment. This means that the valve position predominates in the operating characteristic in the lower opening range only. For this reason the operating characteristic is highly deformed.

By selecting a progressive (equal percentage) transfer characteristic between position set-point value and valve stroke, this can be partially compensated and the operating characteristic linearised within certain limits. **However, the valve authority  $\Psi$  should be  $> 0.1$  even if a correction characteristic is used.**

The control behavior (control quality, transient time) depends greatly on the working point if a correction characteristic is used.

## 34 PROPERTIES OF PID CONTROLLERS

A PID controller has a proportional, an integral and a differential portion (P, I and D portion).

### 34.1 P-portion

Function:

$$Y = K_p \cdot X_d$$

$K_p$  is the proportional coefficient (proportional gain). It is the ratio of the adjusting range  $\Delta Y$  to the proportional range  $\Delta X_d$ .

Characteristic and step response of the P portion of a PID controller

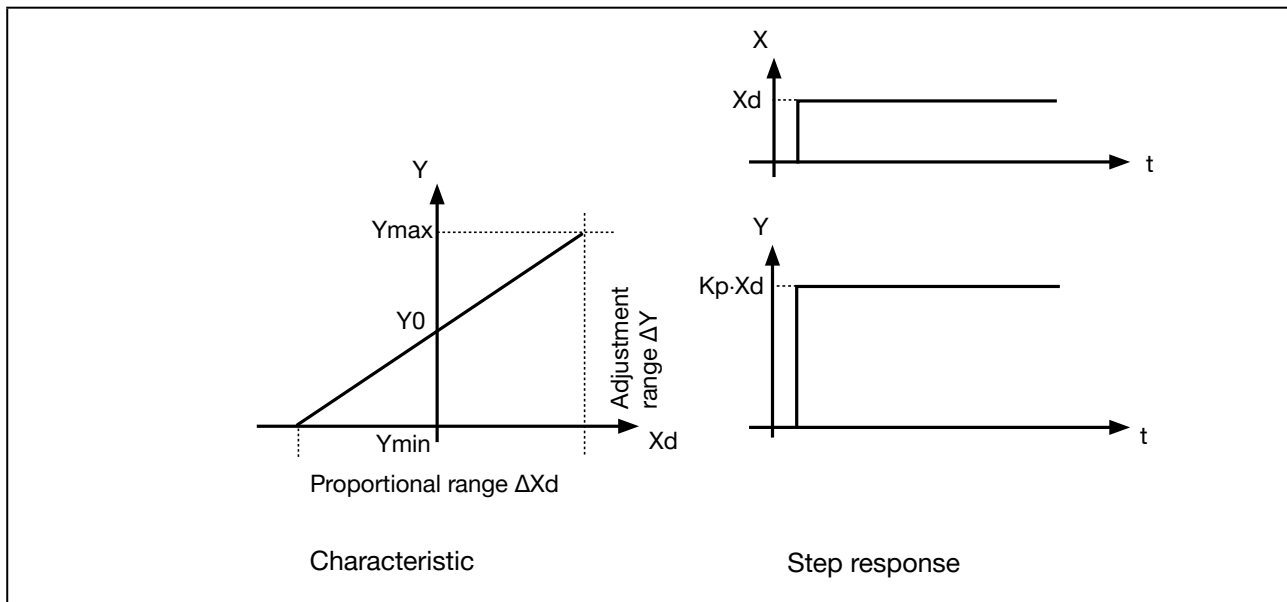


Fig. 123: Characteristic and step response of the P portion of a PID controller

#### Properties

In theory a pure P-controller functions instantaneously, i.e. it is quick and therefore dynamically favorable. It has a constant control difference, i.e. it does not fully correct the effects of malfunctions and is therefore statically relatively unfavorable.

## 34.2 I-portion

Function:

$$Y = \frac{1}{T_i} \int X \, dt \quad (5)$$

$T_i$  is the integral action time or actuating time. It is the time which passes until the actuating variable has run through the whole adjustment range.

Characteristic and step response of the I portion of a PID controller

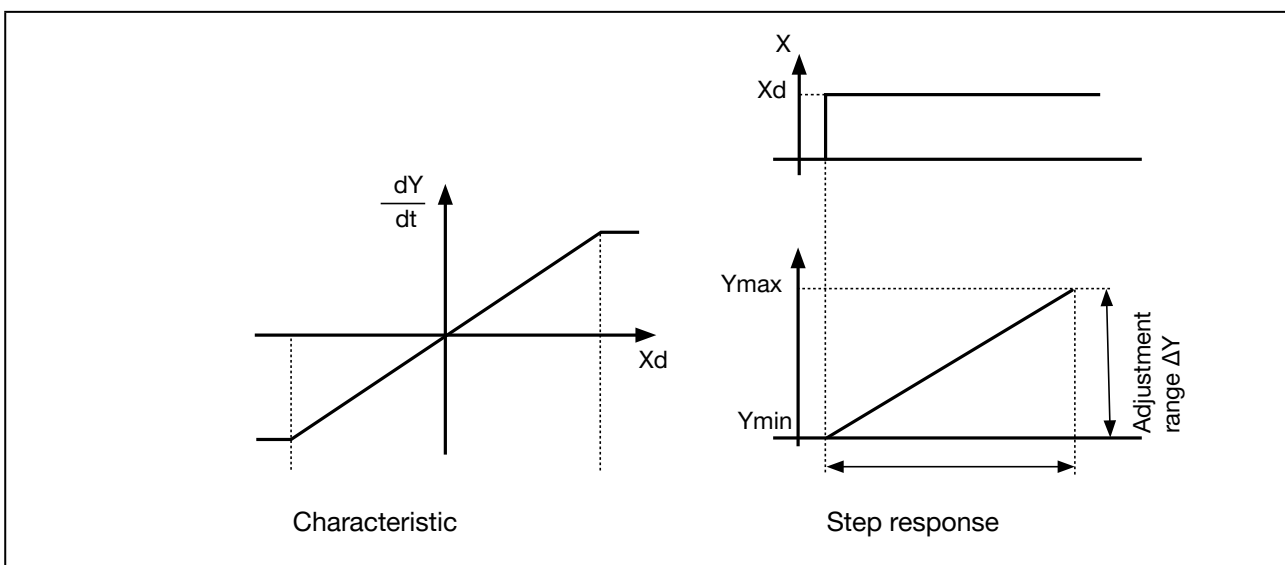


Fig. 124: Characteristic and step response of the I portion of a PID controller

### Properties

A pure I-controller completely eliminates the effects of any malfunctions which occur. It therefore has a favorable static behavior. On account of its final actuating speed control it operates slower than the P-controller and has a tendency to oscillate. It is therefore dynamically relatively unfavorable.

### 34.3 D-portion

Function:

$$Y = K_d \cdot \frac{dX}{dt} \quad (6)$$

$K_d$  is the derivative action coefficient. The larger  $K_d$  is, the greater the D-effect is.

Characteristic and step response of the D-portion of a PID controller

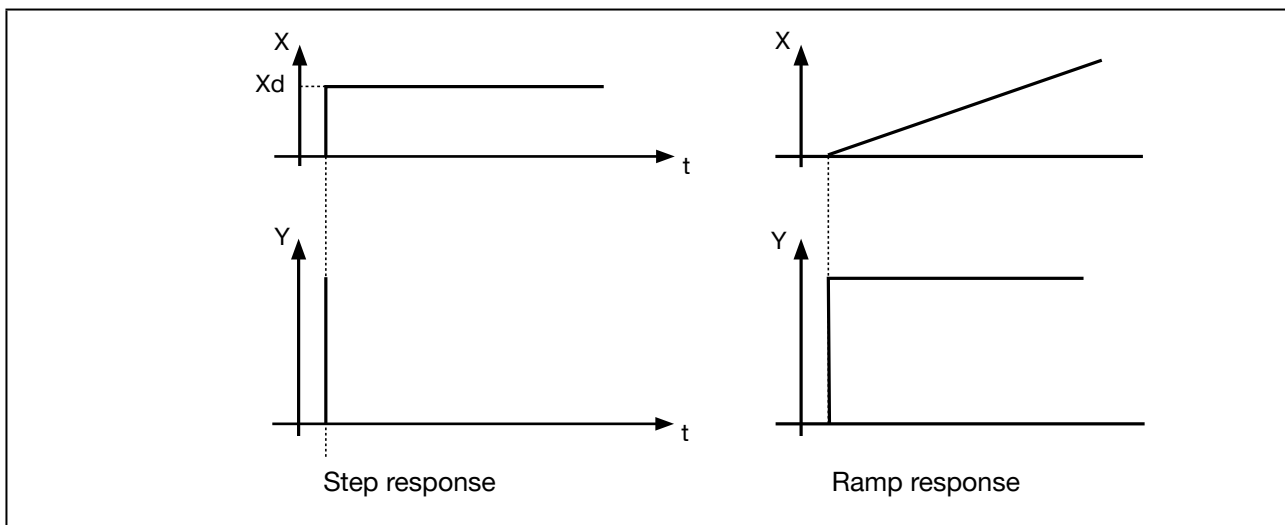


Fig. 125: Characteristic and step response of the D portion of a PID controller

#### Properties

A controller with a D portion responds to changes in the control variable and may therefore reduce any control differences more quickly.

### 34.4 Superposition of P, I and D Portions

Function:

$$Y = K_p \cdot X_d + \frac{1}{T_i} \int X_d dt + K_d \frac{dX_d}{dt} \quad (7)$$

Where  $K_p \cdot T_i = T_n$  and  $K_d/K_p = T_v$  the **function of the PID controller** is calculated according to the following equation:

$$Y = K_p \cdot \left( X_d + \frac{1}{T_n} \int X_d dt + T_v \frac{dX_d}{dt} \right) \quad (8)$$

- $K_p$  Proportional coefficient / proportional gain
- $T_n$  Reset time  
(Time which is required to obtain an equally large change in the actuating variable by the I portion, as occurs due to the P portion)
- $T_v$  Derivative time  
(Time by which a certain actuating variable is reached earlier on account of the D portion than with a pure P-controller)

#### Step response and ramp response of the PID controller

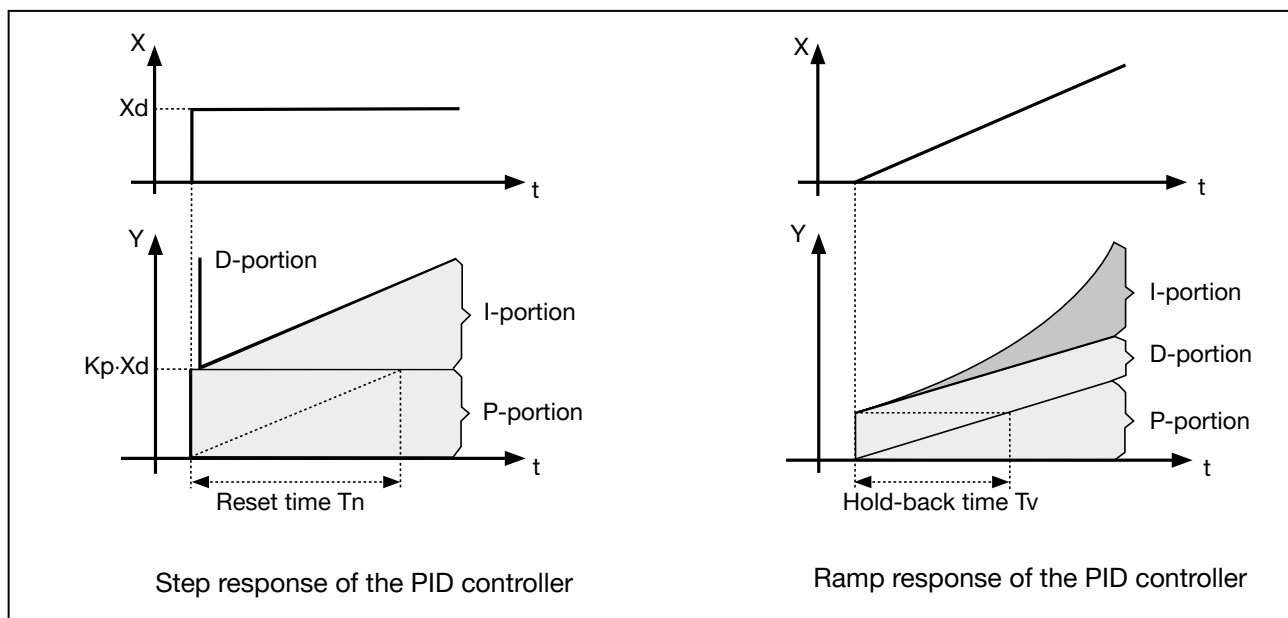


Fig. 126: Characteristic of step response and ramp response of PID controller

## 34.5 Implemented PID controller

### 34.5.1 D Portion with delay

In the process controller Type 8793 the D portion is implemented with a delay T.

Function:

$$T \cdot \frac{dY}{dt} + Y = K_d \cdot \frac{dX_d}{dt} \quad (9)$$

Superposition of P, I and DT Portions

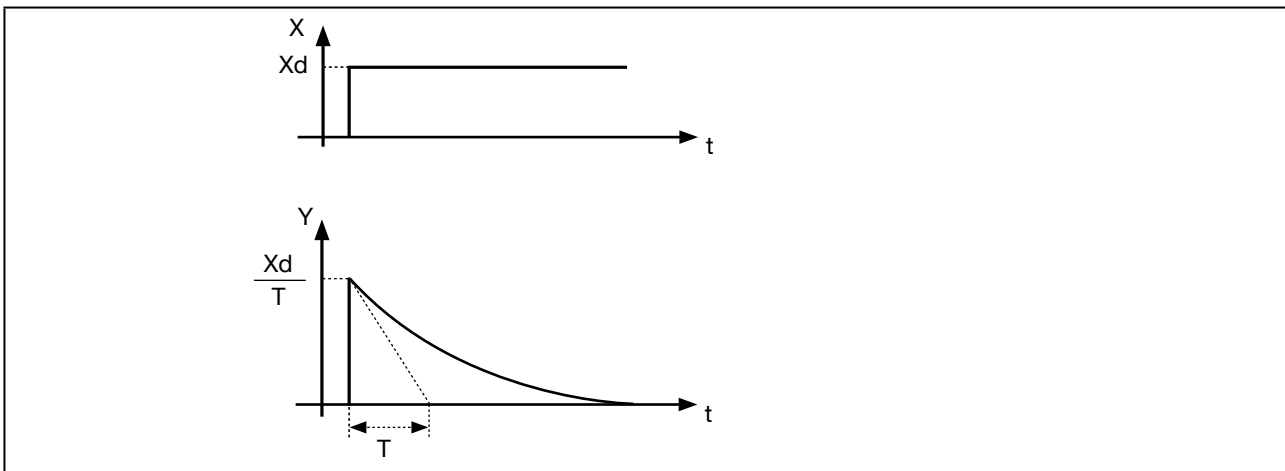


Fig. 127: Characteristic of superposition of P, I and DT Portions

### 34.5.2 Function of the real PID controller

$$T \cdot \frac{dY}{dt} + Y = K_p \left( X_d + \frac{1}{T_n} \int X_d dt + T_v \frac{dX_d}{dt} \right) \quad (10)$$

Superposition of P, I and DT Portions

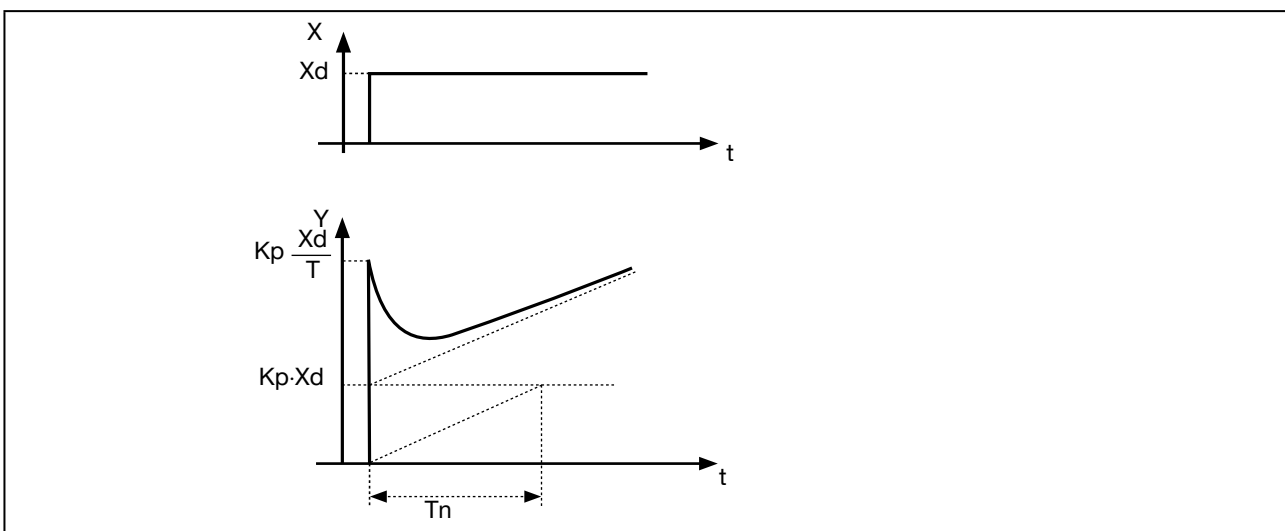


Fig. 128: Characteristic of step response of the real PID controller; adjustment rules for PID controllers



## 35 ADJUSTMENT RULES FOR PID CONTROLLERS

The control system Type 8793 features a self-optimization function for the structure and parameters of the integrated process controller. The determined PID parameters can be seen via the operating menu and re-optimized at will for an empirical path.

The regulatory literature includes a series of adjustment rules which can be used in experimental ways to determine a favorable setting for the controller parameters. To avoid incorrect settings, always observe the conditions under which the particular adjustment rules have been drawn up. Apart from the properties of the control process and the controller itself, the aspect whether a change in the disturbance variable or command variable is to be corrected plays a role.

### 35.1 Adjustment rules according to Ziegler and Nichols (oscillation method)

With this method the controller parameters are adjusted on the basis of the behavior of the control circuit at the stability limit. The controller parameters are first adjusted so that the control circuit starts to oscillate. The occurring critical characteristic values suggest a favorable adjustment of the controller parameters. A prerequisite for the application of this method of course is that the control circuit is oscillated.

#### Procedure

- Set controller as P-controller (i.e.  $T_n = 999$ ,  $T_v = 0$ ), first select a low value for  $K_p$
- Set required set-point value
- Increase  $K_p$  until the control variable initiates an undamped continuous oscillation.

The proportionality coefficient (proportional gain) set at the stability limit is designated as  $K_{krit}$ . The resulting oscillation duration is designated as  $T_{krit}$ .

#### Progress of the control variable at the stability limit

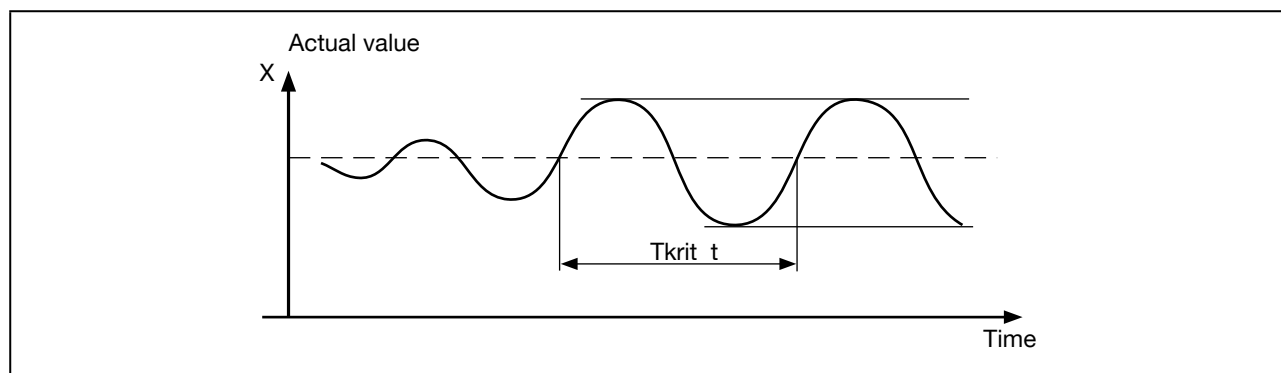


Fig. 129: Progress of the control variable PID

The controller parameters can then be calculated from  $K_{krit}$  and  $T_{krit}$  according to the following table.

**Adjustment of the parameters according to Ziegler and Nichols**

Controller type	Adjustment of the parameters		
P controller	$K_p = 0.5 K_{krit}$	-	-
PI controller	$K_p = 0.45 K_{krit}$	$T_n = 0.85 T_{krit}$	-
PID controller	$K_p = 0.6 K_{krit}$	$T_n = 0.5 T_{krit}$	$T_v = 0.12 T_{krit}$

Table 118: Adjustment of the parameters according to Ziegler and Nichols

The adjustment rules of Ziegler and Nichols have been determined for P-controlled systems with a time delay of the first order and dead time. However, they apply only to controllers with a disturbance reaction and not to those with a reference reaction.

## 35.2 Adjustment rules according to Chien, Hrones and Reswick (actuating variable jump method)

With this method the controller parameters are adjusted on the basis of the transient behavior of the controlled system. An actuating variable jump of 100% is output. The times  $T_u$  and  $T_g$  are derived from the progress of the actual value of the control variable.

Progress of the control variable following an actuating variable jump  $\Delta Y$

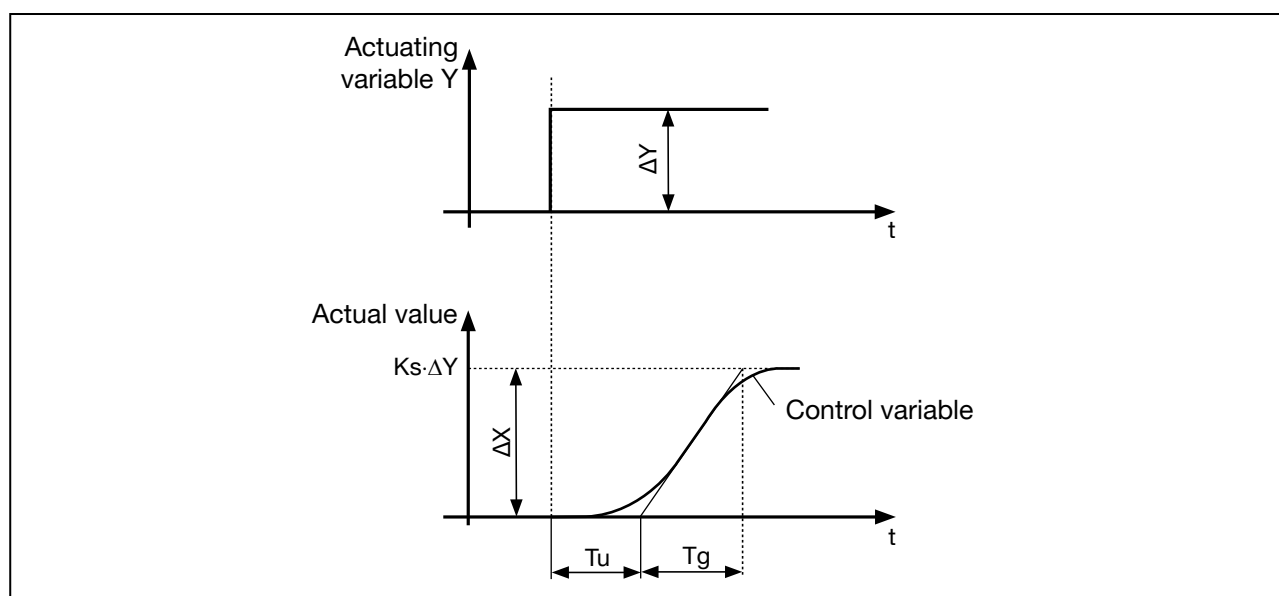


Fig. 130: Progress of the control variable, actuating variable jump

### Procedure

- Switch controller to MANUAL (MANU) operating state
- Output the actuating variable jump and record control variable with a recorder
- If progresses are critical (e.g. danger of overheating), switch off promptly.



Note that in thermally slow systems the actual value of the control variable may continue to rise after the controller has been switched off.

In the following “Table 119” the adjustment values have been specified for the controller parameters, depending on  $T_u$ ,  $T_g$  and  $K_s$  for reference and disturbance reaction, as well as for an aperiodic control process and a control process with a 20% overshoot. They apply to controlled systems with P-behavior, with dead time and with a delay of the first order.

**Adjustment of the parameters according to Chien, Hrones and Reswick**

Controller type	Adjustment of the parameters			
	for aperiodic control process (0% overshoot)		for control process with 20% overshoot	
	Reference	Malfunction	Reference	Malfunction
P controller	$K_p = 0,3 \cdot \frac{T_g}{T_u \cdot K_s}$	$K_p = 0,3 \cdot \frac{T_g}{T_u \cdot K_s}$	$K_p = 0,7 \cdot \frac{T_g}{T_u \cdot K_s}$	$K_p = 0,7 \cdot \frac{T_g}{T_u \cdot K_s}$
PI controller	$K_p = 0,35 \cdot \frac{T_g}{T_u \cdot K_s}$ $T_n = 1,2 \cdot T_g$	$K_p = 0,6 \cdot \frac{T_g}{T_u \cdot K_s}$ $T_n = 4 \cdot T_u$	$K_p = 0,6 \cdot \frac{T_g}{T_u \cdot K_s}$ $T_n = T_g$	$K_p = 0,7 \cdot \frac{T_g}{T_u \cdot K_s}$ $T_n = 2,3 \cdot T_u$
PID controller	$K_p = 0,6 \cdot \frac{T_g}{T_u \cdot K_s}$ $T_n = T_g$ $T_v = 0,5 \cdot T_u$	$K_p = 0,95 \cdot \frac{T_g}{T_u \cdot K_s}$ $T_n = 2,4 \cdot T_u$ $T_v = 0,42 \cdot T_u$	$K_p = 0,95 \cdot \frac{T_g}{T_u \cdot K_s}$ $T_n = 1,35 \cdot T_g$ $T_v = 0,47 \cdot T_u$	$K_p = 1,2 \cdot \frac{T_g}{T_u \cdot K_s}$ $T_n = 2 \cdot T_u$ $T_v = 0,42 \cdot T_u$

Table 119: Adjustment of the parameters according to Chien, Hrones and Reswick

The proportionality factor  $K_s$  of the controlled system is calculated as follows:

$$K_s = \frac{\Delta X}{\Delta Y} \quad (11)$$

## 36 TABLE FOR YOUR SETTINGS ON THE POSITIONER

### 36.1 Settings of the freely programmable characteristic

Node (position set-point value as %)	Valve stroke [%]			
	Date:	Date:	Date:	Date:
0				
5				
10				
15				
20				
25				
30				
35				
40				
45				
50				
55				
60				
65				
70				
75				
80				
85				
90				
95				
100				

MAN 1000118577 EN Version: K Status: RL (released | freigegeben) printed: 05.08.2022



