

# **USER MANUAL**

## **FAULT LOOP IMPEDANCE METER**

### **MZC-304F**

Measuring terminals



Contact electrode

**SET/SEL**

- enter meter settings
- select the digit to change

**Shift/selection**

- right/left
- up/down

- **Turning on the meter** (press shortly)
- **Turning off the meter** (press and hold)
- **Display backlight** (press shortly)

Start the measurement

**ESC**

- return to the previous screen
- exit the function

Approve

**Rotary switch of measurement function selection**

- $Z_{L-PE}$  [RCD] - fault loop impedance in L-PE circuit protected with a RCD
- $Z_{L-PE}$  - fault loop impedance in L-PE circuit
- $Z_{L-N}$   $Z_{L-L}$  - fault loop impedance in L-N or L-L circuit
- **U,f** - voltage and frequency
- $R_{CONT}$  - resistance of protective conductors and equipotential bonding
- $R_x$  - low-voltage resistance measurement
- **MEM** - memory, data transmission

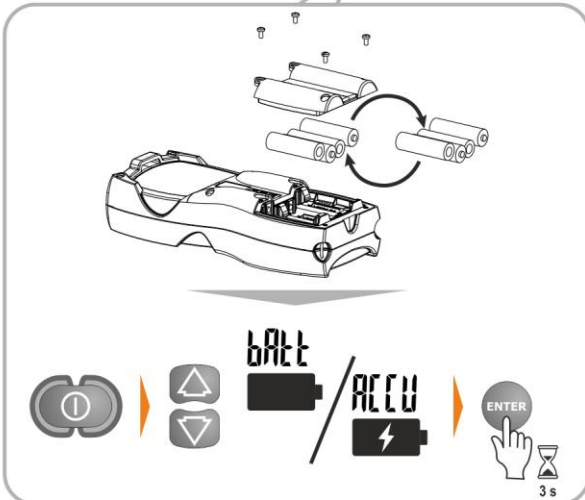



## **USER MANUAL**

# **FAULT LOOP IMPEDANCE METER MZC-304F**



**SONEL S.A.  
Wokulskiego 11  
58-100 Świdnica  
Poland**

Version 1.02 27.09.2023

The MZC-304F is a modern, state-of-the art measuring instrument, easy to operate and safe. Read this manual to avoid mistakes during the measurements and prevent operational problems.

# CONTENTS









<b>1</b>	<b>General information</b>	<b>5</b>
1.1	Safety symbols	5
1.2	Safety	6
<b>2</b>	<b>Quick start</b>	<b>7</b>
2.1	Switching on and off, display backlight	7
2.2	Selecting general measurement parameters	7
2.3	Remembering the last measurement result	7
<b>3</b>	<b>Measurements</b>	<b>10</b>
3.1	AC voltage measurement	10
3.2	Voltage and frequency measurement	10
3.3	Checking the correctness of PE (protective earth) connections	11
3.4	Fault loop parameters	12
3.4.1	Selecting the lead length	12
3.4.2	Prospective short-circuit current	13
3.4.3	Fault loop parameters in the L-N and L-L circuits	14
3.4.4	Fault loop parameters in the L-PE circuit	17
3.4.5	Fault loop impedance in L-PE circuit protected with a residual current device (RCD)	19
3.5	Low-voltage resistance measurement	21
3.5.1	Test leads resistance compensation – auto-zeroing	21
3.5.2	Low-current resistance measurement	22
3.5.3	Measurement of resistance of protective conductors and equipotential bonding with $\pm 200$ mA current	24
<b>4</b>	<b>Memory of measurement results</b>	<b>26</b>
4.1	Entering the measurement results to the memory	26
4.2	Changing the cell and bank number	28
4.3	Browsing the memory	28
4.4	Clearing the memory	30
4.4.1	Clearing the bank	30
4.4.2	Clearing the whole memory	31
4.5	Communication with computer	32
4.5.1	Package for cooperation with computer	32
4.5.2	Data transmission with Bluetooth module	32
<b>5</b>	<b>Troubleshooting</b>	<b>33</b>
<b>6</b>	<b>Power supply</b>	<b>34</b>
6.1	Monitoring the power supply voltage	34
6.2	Replacing the batteries	34
6.3	General rules of using the Nickel Metal Hydride (Ni-MH) batteries	35
<b>7</b>	<b>Cleaning and maintenance</b>	<b>35</b>
<b>8</b>	<b>Storage</b>	<b>36</b>
<b>9</b>	<b>Dismantling and disposal</b>	<b>36</b>
<b>10</b>	<b>Technical data</b>	<b>37</b>
10.1	Basic information	37
10.1.1	Voltage measurement	37

10.1.2	Frequency measurement .....	37
10.1.3	$Z_{L-PE}$ , $Z_{L-N}$ , $Z_{L-L}$ fault loop impedance measurement .....	37
10.1.4	$Z_{L-PE}$ fault loop impedance measurement <span style="border: 1px solid black; padding: 0 2px;">RCD</span> (without tripping the RCD) .....	38
10.1.5	Low-voltage continuity and resistance measurement .....	39
10.2	Other technical specifications .....	39
10.3	Additional information .....	40
10.3.1	Additional uncertainty according to IEC 61557-3 (Z) .....	40
10.3.2	Additional uncertainty according to IEC 61557-4 ( $R \pm 200$ mA) .....	40
<b>11</b>	<b>Manufacturer .....</b>	<b>40</b>

# 1 General information

## 1.1 Safety symbols

The following international symbols are used in the device and/or in this manual:

	Warning; See explanation in the manual		Ground		AC current/voltage
	DC current/voltage		Dual insulation (Protection class)		Declaration of Conformity with EU directives ( <i>Conformité Européenne</i> )
	Do not dispose of with other household waste		Recycling information		Confirmed compliance with Australian Standards

Measurement categories according to IEC 61010-2-030:

- **CAT II** – concerns measurements performed in circuits directly connected to low voltage installations,
- **CAT III** – concerns measurements performed in buildings installations,
- **CAT IV** – concerns measurements performed at the source of low voltage installation.

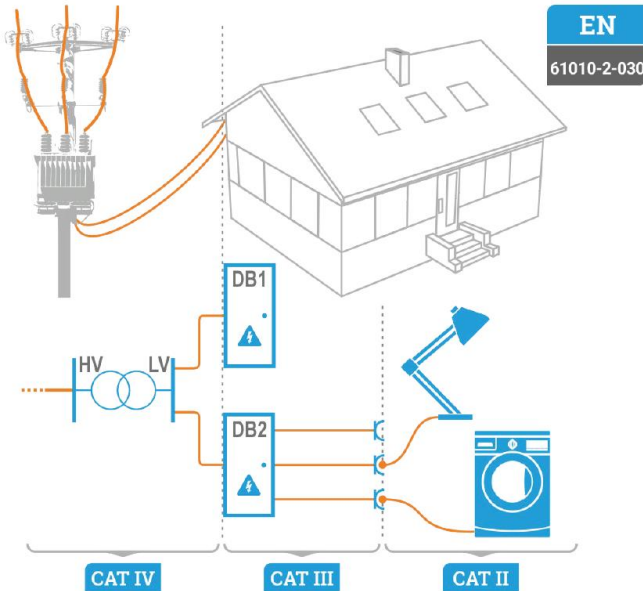

## 1.2 Safety

The meter is designed for testing the protection against electric shock in the mains systems. The meter is used to make measurements which results determine the electrical installation safety level. Consequently, in order to ensure safe operation and correct measurement results, observe the following recommendations:

- Before you proceed to operate the meter, acquaint yourself thoroughly with the present manual and observe the safety regulations and recommendations of the manufacturer.
- Any application that differs from those specified in the present manual may cause damage of the instrument and a serious hazard to its user.
- The meters must be operated solely by appropriately qualified personnel with relevant certificates to perform measurements of electric installation. Operation of the instrument by unauthorized personnel may result in damage to the device and constitute a hazard to the user.
- Using this manual does not exclude the need to comply with occupational health and safety regulations and with other relevant fire regulations required during the performance of a particular type of work. Before starting the work with the device in special environments, e.g. potentially fire-risk/explosive environment, it is necessary to consult it with the person responsible for health and safety.
- It is unacceptable to operate the following:
  - ⇒ a damaged meter which is completely or partially out of order,
  - ⇒ leads with damaged insulation,
  - ⇒ a meter which has been stored too long in unsuitable conditions (for example is wet). When the meter is transferred from cold environment to warm and humid one, do not make measurements until the meter warms up to the ambient temperature (about 30 minutes).
- Remember that the **batt** message on the display means that the power supply voltage is too low and indicates the need to replace/ charge the batteries. The measurements performed with the meter with insufficient supply voltage have additional measuring errors which are impossible to be evaluated by the user and cannot be the basis to determine the correct protection of the tested installation.
- Do not leave the discharged batteries in the meter as they can leak and damage the instrument.
- Before starting the measurement, check if the leads are connected to correct measuring terminals.
- Never use the meters with open or only partially closed battery compartment cover and use only the power supplies specified in this manual.
- Repairs may be performed solely by an authorized service outlet.



### NOTE!

Only accessories for a given device should be used. Using other accessories may cause damage to measuring terminals, introduce additional measurement error and create a risk for the user.



- An attempt to install drivers in 64-bit Windows 8 and Windows 10 may result in displaying "Installation failed" message.
  - Cause: Windows 8 and Windows 10 by default blocks drivers without a digital signature.
  - Solution: Disable the driver signature enforcement in Windows.
- Due to continuous development of the meter's software, the actual appearance of the display, in case of some of the functions, may slightly differ from the display presented in this operating manual.



## 2 Quick start

### 2.1 Switching on and off, display backlight



To **switch on** the meter, briefly press the  button. To **switch off**, press the same button longer (the **OFF** message appears).

To switch on/off the display and keypad **backlight** during the meter operation, briefly press the  button.



### 2.2 Selecting general measurement parameters

**1**  +  Keeping the **SET/SEL** button depressed, switch on the meter and wait for the parameter selection screen to appear.





Use the   buttons to go to next parameter.



Use the   buttons to change the parameter value. The value or symbol to be changed is flashing.

**2** Set the parameters according to the algorithm.

**3**  /  Press and hold **ENTER** (until a signal sounds – ca. 3 s) to save the changes and go to the measurement function or press **ESC** to go the measurement function without saving the changes.



- **At first start-up** or **after replacing batteries**, select the type of power supply: rechargeable batteries (ACCU) or batteries (BATT). General measurement parameters can be selected in the same menu.
- Before the first measurements, set the mains rated voltage  $U_n$  (220/380 V, 230/400 V or 240/415 V) which is applicable in the test location. The voltage is used to calculate the prospective short-circuit current, if this option was chosen from the main menu.
- The  symbol in the time to auto-off settings, indicates disabling this function.
- PIN settings – see **Meter settings** schematic.
- Software upgrade – see **Meter settings** schematic and **section 4.5**.

### 2.3 Remembering the last measurement result

The result of the last measurement is remembered until the next measurement is activated, the measurement parameters are changed or the measuring function is changed with the rotary switch. Use the **ESC** button to go to the starting screen of a given function and press **ENTER** to display the last measurement result.

## Meter settings – algorithm

	Mains voltage	Mains frequency	Result of impedance measurement: short-circuit current / impedance	Voltage for calculating $I_k$ : rated / measured	Auto-OFF ▪ disabled ▪ time to automatic shutdown	Bluetooth communication: enabled / disabled
	$U_N$	$f_N$	LOOP DISP	$I_k$	OFF	BT
▲ ▼	<ul style="list-style-type: none"> <li>▪ 220 V</li> <li>▪ 230 V</li> <li>▪ 240 V</li> </ul>	<ul style="list-style-type: none"> <li>▪ 50 Hz</li> <li>▪ 60 Hz</li> </ul>	<ul style="list-style-type: none"> <li>▪ <math>I_k</math></li> <li>▪ Z</li> </ul>	<ul style="list-style-type: none"> <li>▪ U</li> <li>▪ <math>U_N</math></li> </ul>	<ul style="list-style-type: none"> <li>▪ ---</li> <li>▪ 300 s</li> <li>▪ 600 s</li> <li>▪ 900 s</li> </ul>	<ul style="list-style-type: none"> <li>▪ on</li> <li>▪ off</li> </ul>

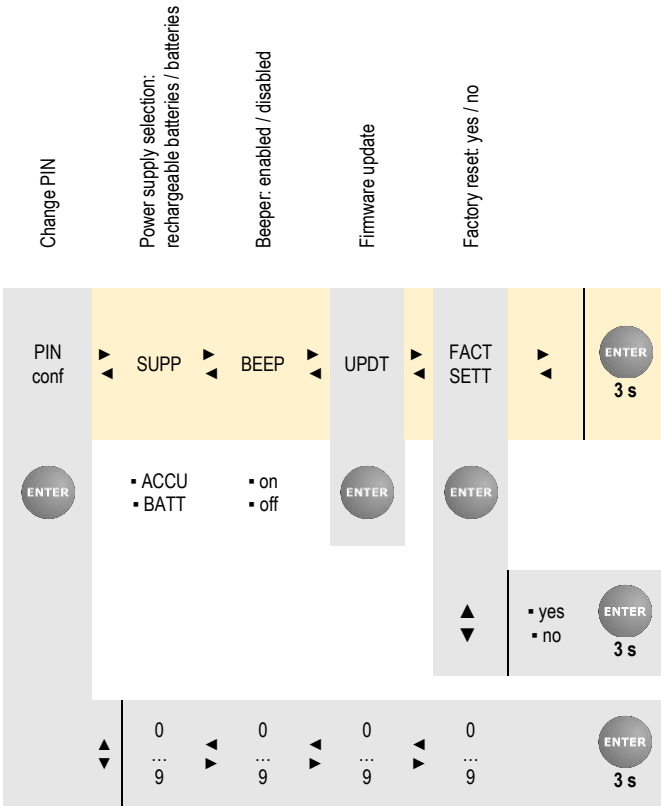

## 3 Measurements



### WARNING

- During the measurements (fault loop impedance) never touch the earthed and accessible parts in the tested electrical installation.
- During the measurement do not switch the rotary switch as this may cause damage of the meter and hazard for the user.



Message ---{ no indicates, that an incompatible measurement adapter is connected to the meter.

### 3.1 AC voltage measurement

The meter measures and displays the mains alternating voltage in all measurement functions with the exception of R. The voltage is measured for the 45...65 Hz frequency range. The test leads should be connected as for a given measuring function.

### 3.2 Voltage and frequency measurement

①

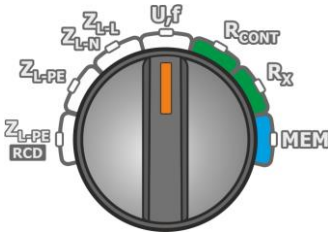

Set the rotary switch to the U,f position.

②



Read the measurement result: frequency in the main display field, voltage in the auxiliary field.

### 3.3 Checking the correctness of PE (protective earth) connections

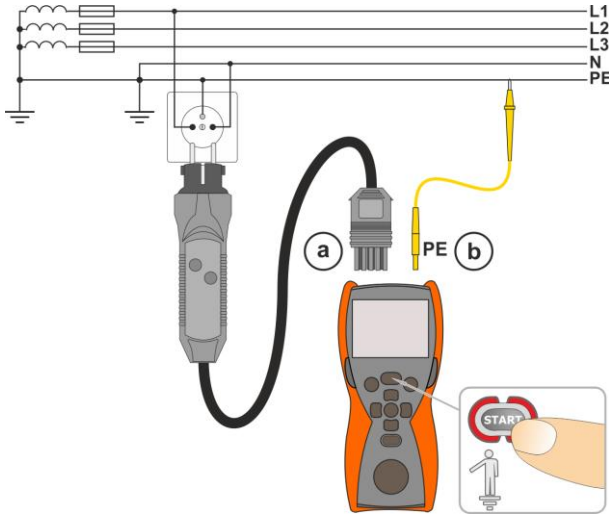

Connect the meters as shown in the figure, touch the contact electrode with your finger and wait about 1 second. When the voltage on the **PE** conductor is detected, the instrument displays the **PE** message (error in the installation, the PE conductor is connected to the phase conductor) and generates a continuous audio signal. This option is available for all measurement functions related to the fault loop, except for Z<sub>L-N,L-L</sub>.



#### WARNING

**When dangerous voltage on the protective conductor PE is detected, discontinue the measurements immediately and repair the electrical installation.**



- Make sure that during the measurements you are not standing on an uninsulated floor as this may cause erroneous results.
- The threshold value, which triggers the signal of exceeded allowable voltage on PE conduit, is approximately 50 V.

### 3.4 Fault loop parameters



#### NOTE!

- If the tested mains includes residual current devices, for the duration of measurement they should be omitted by bypassing. Remember however that bypassing changes the tested circuit and the results may very slightly differ from the actual values.
- After the measurement, restore the mains to its original state and check operation of the residual current device. This note does not apply to the earth loop impedance measurements with the  $Z_{L-PE}$  **RCD** function.
- Measurements of fault loop impedance performed downstream of inverters are ineffective and their results are unreliable. This is due to the instability of internal impedance in inverter circuits during its operation. The measurements of fault loop impedance should not be performed directly downstream of inverters.

#### 3.4.1 Selecting the lead length

1

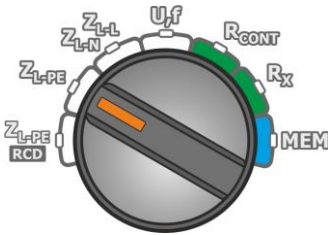

- Switch on the meter.
- Set the rotary switch to one of the fault loop impedance measurement types.

2

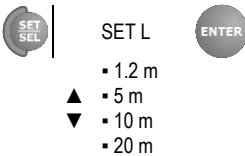

Set the parameters according to the following algorithm and the rules for setting the general parameters.



- Using original leads and selecting correct length is a guarantee of keeping the declared measuring accuracy.
- The **WS** leads are detected by the meter and you cannot select their length (the  $\overline{\overline{E}}$  symbol is displayed). When you are using the leads with banana plugs, before you start the measurements set the correct phase conductor length complying with the test leads length.

### 3.4.2 Prospective short-circuit current

The meter always measures the impedance, and the displayed short-circuit current is calculated according to the following formula:

$$I_k = \frac{U_n}{Z_s}$$

where:

$U_n$  – rated voltage of the tested mains,

$Z_s$  – measured impedance.

Based on the rated voltage  $U_n$  selected in the general settings (**section 2.2**), the meter automatically detects the measurement with phase-to-neutral or phase-to-phase voltage and includes this in the calculations.

If the tested mains voltage is out of tolerance range, the meter will not be able to determine the correct rated voltage for calculation of short-circuit current. In such case, horizontal lines will be displayed instead of the short-circuit current. The figure below shows the voltage ranges for which the short-circuit current is calculated.

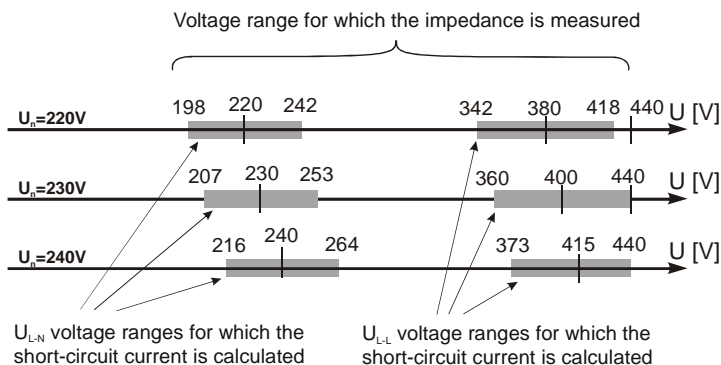

### 3.4.3 Fault loop parameters in the L-N and L-L circuits

1

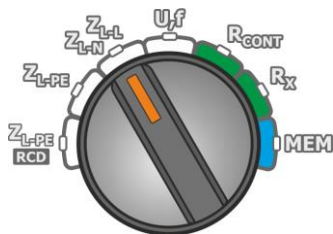

- Switch on the meter.
- Set the rotary switch to the **Z<sub>L-L</sub> Z<sub>L-N</sub>** position.
- Select the leads length as described in **sec. 3.4.1** according to the needs.

2 Connect the test leads as shown in the figure:

- (a) (b) for measurement in the L-N circuit,  
 (c) measurement in the L-L circuit

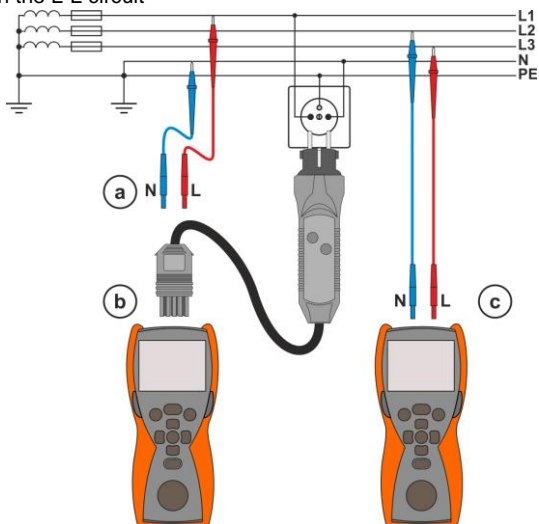

3

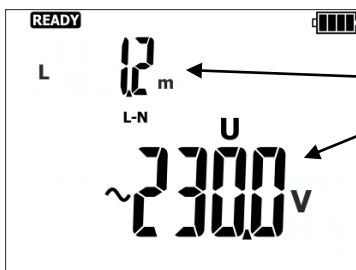

The meter is ready for measurement.

Phase conductor length or the  $\sim E$  symbol.

$U_{L-N}$  or  $U_{L-L}$  voltage

4



Press **START** to perform the measurement.



5

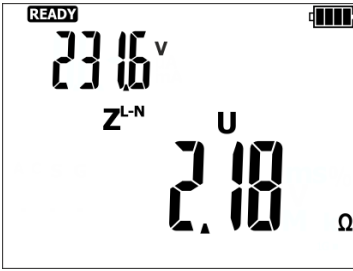

Read the main result: the fault loop impedance  $Z_S$  and the mains voltage during the measurement.

6

Press ► to display additional results.

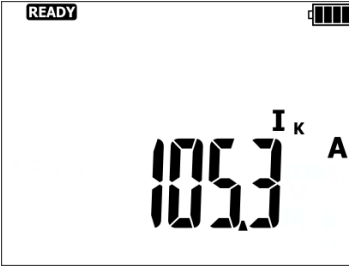

Short-circuit current  $I_k$



Fault loop resistance  $R$

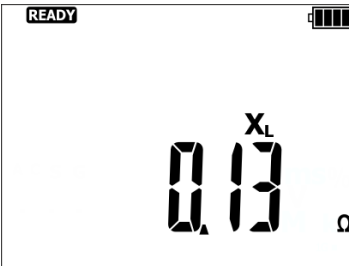



Fault loop reactance  $X_L$



- Save the result in the memory (see **sections 4.1, 4.2**) or press **ESC** to return to the voltage measurement.
- Making a large number of tests over a short time causes the meter to emit a lot of heat. As a result the casing may become warm. This is normal. The meter has an overheat protection.
- The minimum time between successive measurements is 5 seconds. This value is controlled by the meter which displays the **READY** message when you can make the next measurement.

## Additional information displayed by the meter

<b>READY</b>	Meter ready for measurement
L-N	Voltage on the meter <b>L</b> and <b>N</b> terminals is out of range for which the measurement can be made.
L-PE	Voltage on the meter <b>L</b> and <b>PE</b> terminals is out of range for which the measurement can be made.
Err	Measurement error
Errf	Incorrect or unstable power grid frequency.
ErrU	Measurement error – loss of voltage after the measurement.
E00	Short-circuit loop of the meter is faulty.
ULn	N conductor not connected.
<b>NOISE!</b>	Message (displayed after the measurement) indicates significant disturbances in the mains during measurement. The measurement result may include a large, unspecified error.
	Temperature inside the meter has exceeded the allowed limit. The measurement is blocked.
	The L and N conductors are switched (voltage between the <b>PE</b> and <b>N</b> conductors).

### 3.4.4 Fault loop parameters in the L-PE circuit

1

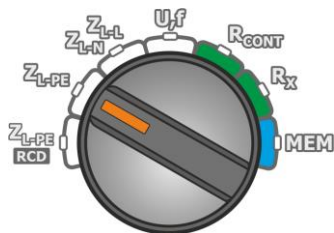

- Switch on the meter.
- Set the rotary switch to the  $Z_{L-PE}$  position.
- Select the leads length as described in **sec. 3.4.1** according to the needs.

2 Connect the test leads as shown in one of the figures.

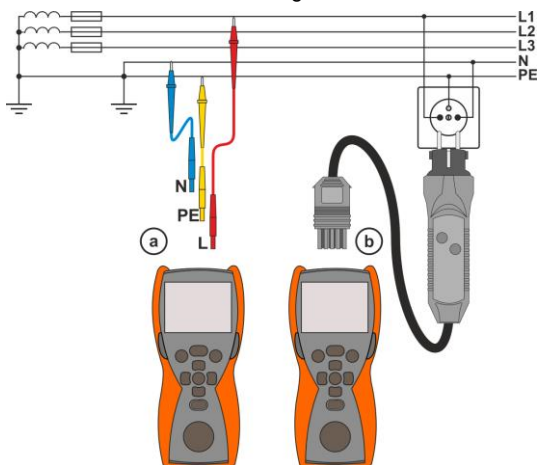

Measurement in L-PE circuit

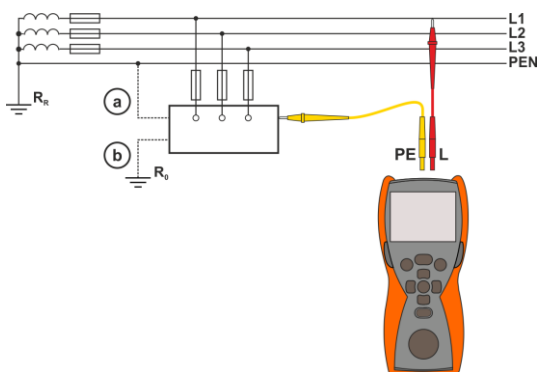

Checking effectiveness of protection against electric shock of the meter housing in case of:

- Ⓐ TN network or Ⓑ TT network

3

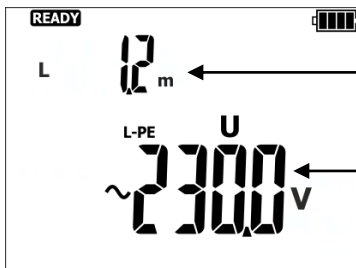

The meter is ready for measurement.

Phase conductor length or the  $\sim E$  symbol.

$U_{L-PE}$  voltage

4



Press **START** to perform the measurement.

The remaining measurement issues are analogous to the ones described for the measurements in the L-N or L-L systems.



A double-lead measurement is possible when selecting the test lead other than with the socket adapter.

## Additional information displayed by the meter

<b>READY</b>	Meter ready for measurement
L-n	Voltage on the meter <b>L</b> and <b>N</b> terminals is out of range for which the measurement can be made.
L-PE	Voltage on the meter <b>L</b> and <b>PE</b> terminals is out of range for which the measurement can be made.
Err	Measurement error
Errf	Incorrect or unstable power grid frequency.
ErrU	Measurement error – loss of voltage after the measurement.
E00	Short-circuit loop of the meter is faulty.
ULn	N conductor not connected.
<b>NOISE!</b>	Message (displayed after the measurement) indicates significant disturbances in the mains during measurement. The measurement result may include a large, unspecified error.
	Temperature inside the meter has exceeded the allowed limit. The measurement is blocked.
	The L and N conductors are switched (voltage between the <b>PE</b> and <b>N</b> conductors).

### 3.4.5 Fault loop impedance in L-PE circuit protected with a residual current device (RCD)

The meter allows the fault loop impedance measurements without making changes in the mains with the residual current devices with rated current of minimum 30 mA.

1

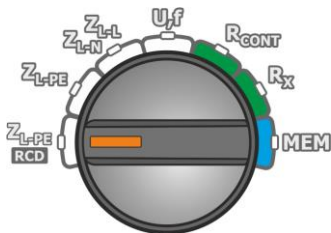

- Switch on the meter.
- Set the rotary switch to the  $Z_{L-PE}$  **RCD** position.
- Select the leads length as described in **sec. 3.4.1** according to the needs.

2

Connect the test leads as shown in one of the figures.

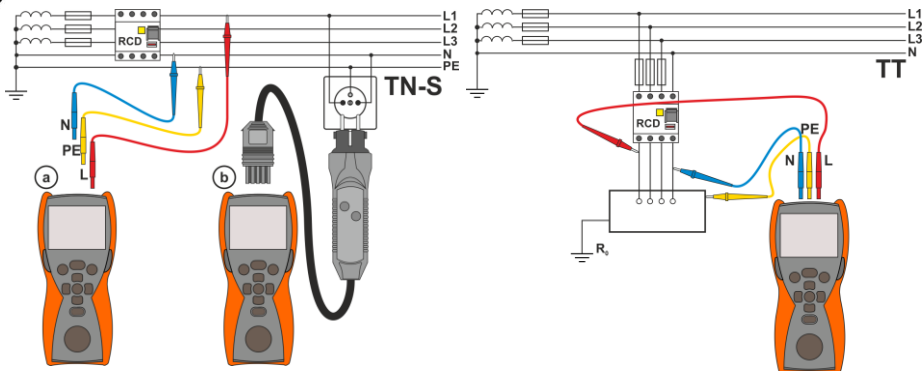

Measurement in a TN-S system

Measurement in a TT system

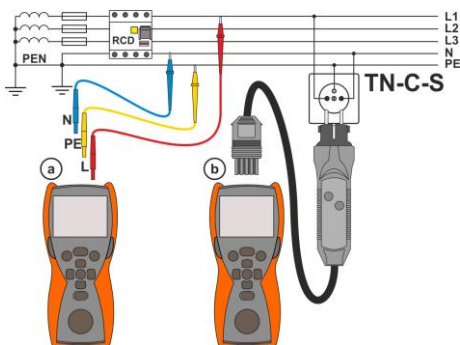

Measurement in a TN-C-S system

The remaining measurement issues are analogous to the ones described for the measurements in the L-N or L-L systems.



- You can discontinue the measurement by pressing the **ESC** button.
- In a mains without interferences, the measurement takes ca. 8 seconds. If interferences occur, this time may be longer.
- In the electrical installations with the 30 mA residual current devices the sum of the installation leakage currents and the test current may trip the RCD. In such case, try to reduce the leakage current of the tested installation (i.e. by disconnecting the loads).

## Additional information displayed by the meter

<b>READY</b>	Meter ready for measurement
L-n	Voltage on the meter <b>L</b> and <b>N</b> terminals is out of range for which the measurement can be made.
L-PE	Voltage on the meter <b>L</b> and <b>PE</b> terminals is out of range for which the measurement can be made.
Err	Measurement error
Errf	Incorrect or unstable power grid frequency.
ErrU	Measurement error – loss of voltage after the measurement.
E00	Short-circuit loop of the meter is faulty.
ULn	N conductor not connected.
<b>NOISE!</b>	Message (displayed after the measurement) indicates significant disturbances in the mains during measurement. The measurement result may include a large, unspecified error.
	Temperature inside the meter has exceeded the allowed limit. The measurement is blocked.
	The L and N conductors are switched (voltage between the <b>PE</b> and <b>N</b> conductors).

### 3.5 Low-voltage resistance measurement



NOTE!

Do not connect to the meter voltage above 440 V DC as this can damage the instrument.

#### 3.5.1 Test leads resistance compensation – auto-zeroing

1

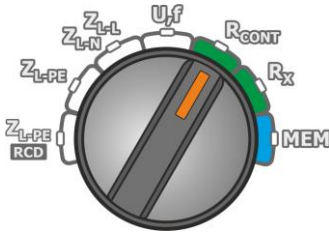

- Switch on the meter.
- Set the rotary switch to the **R<sub>CONT</sub>** or **R<sub>x</sub>** position.

2

Set auto-zeroing according to the following algorithm.



3

Close the test leads.

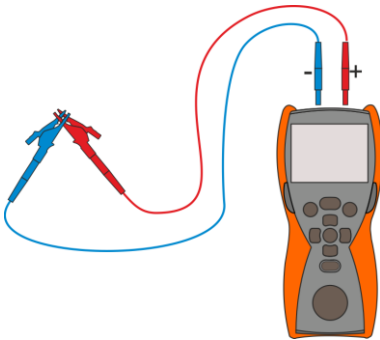

4



Press **START** to commence the auto-zeroing.

5

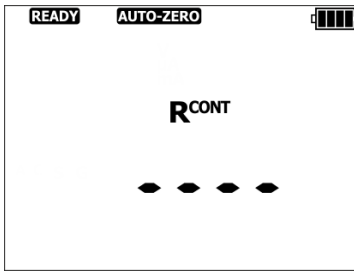

When auto-zeroing is completed, the meter automatically goes to the “ready for measurement” screen.



- The **AUTO-ZERO** message is still displayed after switching to one of the measurement functions (resistance or continuity measurement) in order to indicate that the measurement is being made with compensated test leads resistance.
- To remove compensation, perform the activities described above but with open test leads. The **AUTO-ZERO** message will not be displayed in the measurement screen.

### Additional information displayed by the meter

	<p>Tested facility is live. The measurement is blocked. <b>Immediately disconnect the meter from the facility (both leads).</b></p>
--	---

### 3.5.2 Low-current resistance measurement

1

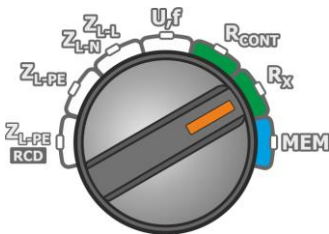

- Switch on the meter.
- Set the rotary switch to the R<sub>x</sub> position.

2

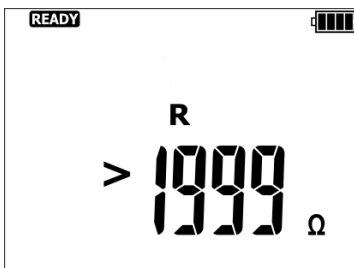

The meter is ready for measurement.



3

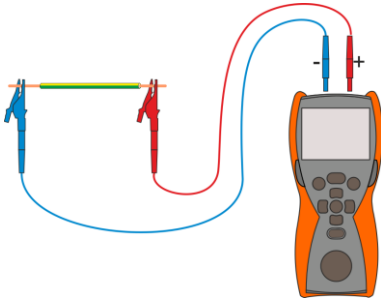

Connect the test leads as shown in the figure.

4

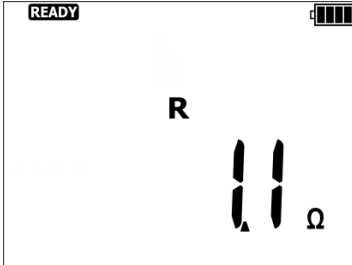

Read the measurement result.

## Additional information displayed by the meter

UdEt

Tested facility is live. The measurement is blocked. **Immediately disconnect the meter from the facility (both leads).**

NOISE!

Message (displayed after the measurement) indicates significant disturbances in the mains during measurement. The measurement result may include a large, unspecified error.

> 1999 Ω

Measurement range is exceeded.

### 3.5.3 Measurement of resistance of protective conductors and equipotential bonding with $\pm 200$ mA current

1



- Switch on the meter.
- Set the rotary switch to the  $R_{CONT}$  position.

2

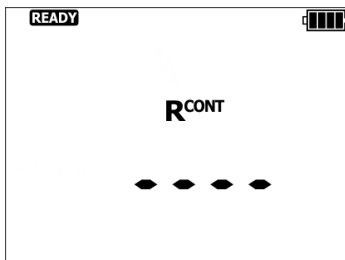

The meter is ready for measurement.

3

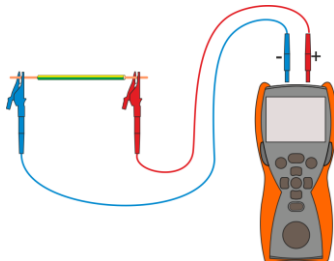

Connect the test leads as shown in the figure. The measurement starts automatically for resistance values below  $100 \Omega$ .

4

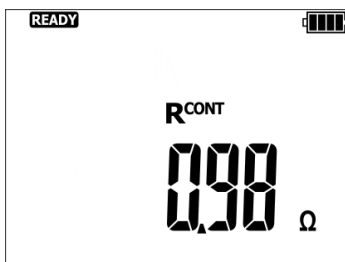

Read the measurement result.

The result is the arithmetic mean of the values of two measurements at a current of  $200$  mA with opposite polarities  $R_{CONT-}$  and  $R_{CONT+}$ .

$$R = \frac{R_{CONT-} + R_{CONT+}}{2}$$

5 Press ► to read additional results.

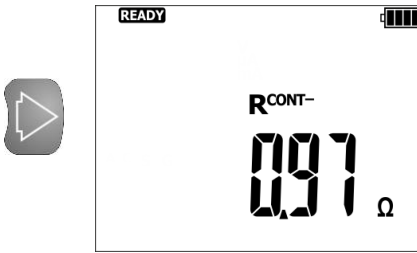

R<sub>CONT-</sub> – resistance measured with 200 mA negative polarity current

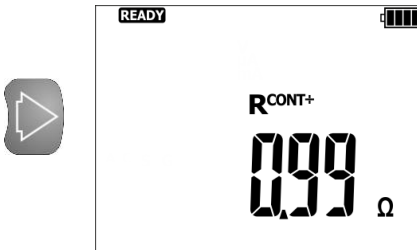

R<sub>CONT+</sub> – resistance measured with 200 mA positive polarity current

6



Press **START** to start the next measurement without disconnecting the test leads or to measure the resistance above >100 Ω.

## Additional information displayed by the meter

UdEt

Tested facility is live. The measurement is blocked. **Immediately disconnect the meter from the facility (both leads).**

NOISE!

Message displayed after the measurement, it indicates significant divergences between the partial measurements (point 6). The measurement result may include a large, unspecified error. Possible causes:

- too much disturbances in the measured object,
- instability of the object or of the meter's connection with the object (unreliable galvanic connection).

> 400 Ω

Measurement range is exceeded.

## 4 Memory of measurement results

The meter has the memory for 10 000 individual measurement results. The whole memory is divided into 10 banks with 99 cells each. Due to dynamic memory allocation, each cell can contain a different number of individual results, depending on the needs. This ensures optimum memory use. Each result can be saved in a cell of a specified number and in a chosen bank, thus allowing the user to assign the cell numbers to measurement points, and the bank numbers to tested facilities, make the measurement in any sequence and repeat the measurements without losing other data.

The memory of measurement results is **not cleared** when the meter is switched off. The data can be read later or transmitted to a computer. The number of the current cell and bank is not changed, either.



- One cell can contain the results of measurements made for all measurement functions.
- After each entry of measurement result to a cell, the cell number is automatically increased. To enter the successive results relating to a given measurement point (facility) to one cell, set the correct cell number before each entry.
- Only the results of measurements activated with the **START** button can be entered to the memory (with exception of auto-zeroing in the low-voltage resistance measurement).
- It is recommended to clear the memory after reading the data or before a new series of measurements, results of which can be saved in the same cells as previous ones.

### 4.1 Entering the measurement results to the memory

1



After the measurement, press **ENTER**.

2

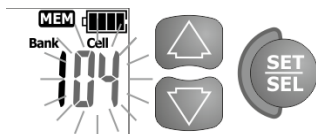

The meter is in the memory enter mode. Select the bank and cell number acc. To **section 4.2** or leave the current ones.



Cell is empty.



Cell includes the same type of result that is to be entered.

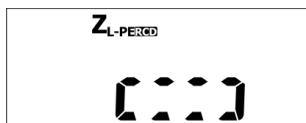

Cell is occupied by the displayed type of measurement results.



Cell is occupied by the displayed types of measurement results.

3



Confirm by pressing **ENTER**.

4

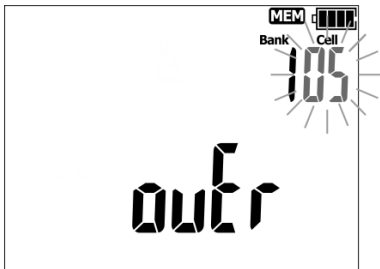

An attempt to overwrite the results triggers the warning message.



Press **ENTER** to overwrite the result or **ESC** to abort.

5

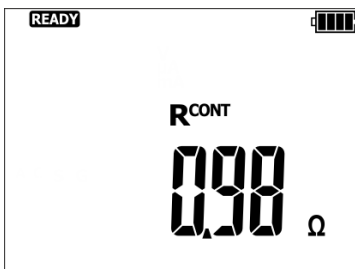

The screen shown left appears for a moment accompanied by three short audio signals. Then, the meter again displays the last measurement result.



The saved data include a complete set of results (main and additional) for a given measurement function plus the set measurement parameters.

## 4.2 Changing the cell and bank number

①

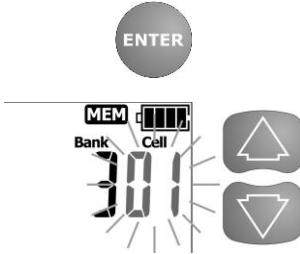

After the measurement, press **ENTER**. The meter is in the memory enter mode.

The cell number is flashing.

Use the ▲▼ arrows to change the cell number.

②

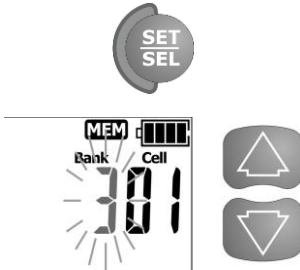

Use the **SET/SEL** button to set the active (flashing) cell or bank number.

The bank number is flashing.

Use the ▲▼ arrows to change the bank number.

## 4.3 Browsing the memory

①

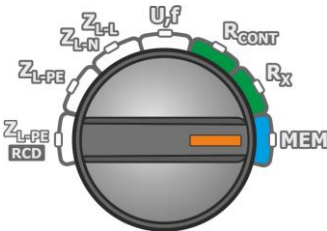

- Switch on the meter.
- Set the rotary switch to the **MEM** position.

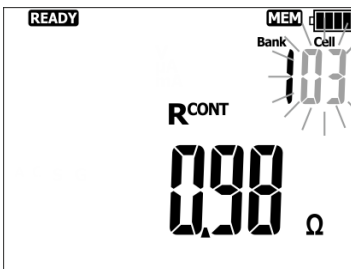

The content of last saved cell is displayed.

The cell number is flashing.

The bank and cell number which you wish to browse is changed with the **SET/SEL** button and then with the ▲▼ arrows. If the cell/ bank number is flashing, it can be changed.

The sequence of saving the individual measurement results is given in the table below:

Measurement function (result group)	Component results
$Z_{L-N, L-L}$	$Z_{L-N}$ or $Z_{L-L}$
	and
	$U_{L-N}$ or $U_{L-L}$
	$I_K$
	$R$
	$X_L$
	$Z_{L-PE}$ and $U_{L-PE}$
$Z_{L-PE}$ or $Z_{L-PE}$ <span style="border: 1px solid black; padding: 2px;">RCD</span>	$I_K$
	$R$
	$X_L$
$R_{CONT}$	$R_{CONT}$
	$R_{CONT-}$
	$R_{CONT+}$

## 4.4 Clearing the memory

### 4.4.1 Clearing the bank

①

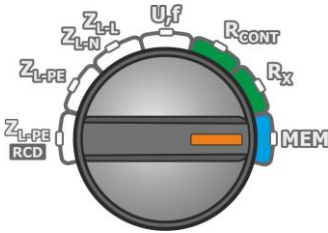

- Switch on the meter.
- Set the rotary switch to the **MEM** position.

②

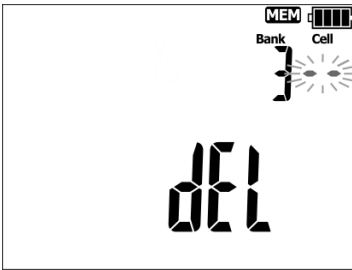

Set the number of bank to be cleared as described in **sec. 4.2**.

Set the cell number to **••** (before 1). The **del** message appears, signaling that the meter is ready to delete.

③

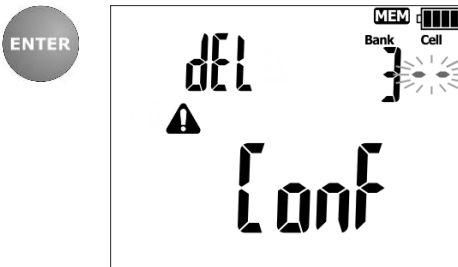

Press **ENTER**. The **Conf** and **▲** symbols appear, requiring confirmation.

④

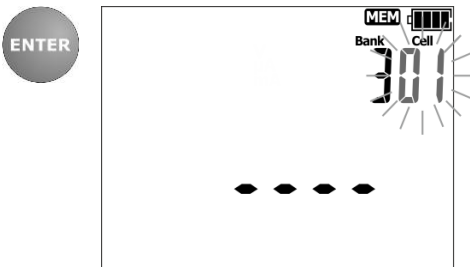

Press **ENTER** to start deleting or **ESC** to abort.

The deletion progress is shown on the screen as scrolling cell numbers. When deletion is completed, the meter generates three short audio signals and sets the cell number to 1.



## 4.4.2 Clearing the whole memory

1

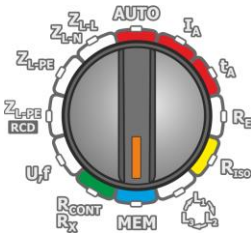

- Switch on the meter.
- Set the rotary switch to the **MEM** position.

2

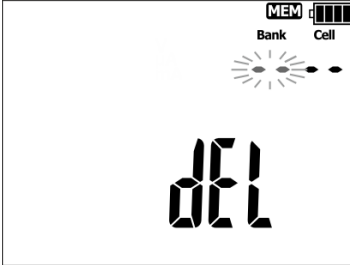

Set the bank number to  $\leftarrow$  (before 0). The **del** message appears, signaling that the meter is ready to delete.

3

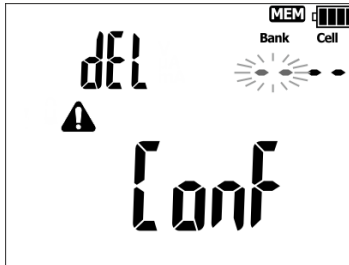

Press **ENTER**. The **Conf** and **!** symbols appear, requiring confirmation.

4

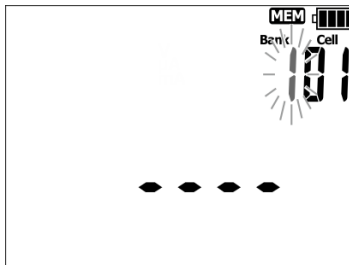

Press **ENTER** to start deleting or **ESC** to abort.

The deletion progress is shown on the screen as scrolling bank and cell numbers. When deletion is completed, the meter generates three short audio signals and sets the cell number to 1.

## 4.5 Communication with computer









### 4.5.1 Package for cooperation with computer

In order to ensure the communication of the meter with a computer, additional Bluetooth module and software is required. A program that may be used for this purpose is **Sonel Reader**. It allows users to read and display the measurement data stored in the meter memory. This program may be downloaded free from the manufacturer's website. Information on the availability of other programs cooperating with the meter may be obtained from the manufacturer or its authorized distributors.

The software may be used for many devices manufactured by SONEL S.A. which are equipped with the USB interface and/or wireless module.

Detailed information regarding software is available from the manufacturer or an authorized distributor.

### 4.5.2 Data transmission with Bluetooth module

- 1  +  Keeping the **SET/SEL** button depressed, switch on the meter and wait for the parameter selection screen to appear (see **sec. 2.2**).
- 2   Using buttons ◀▶ go to parameter **bt**.
- 3   Using buttons ▲▼ select **on**.
- 4  Press and hold **ENTER** to save the changes. From now on the symbol  will be visible on the screen.
- 5 Connect Bluetooth module to the USB socket of the PC, unless it is integrated into the PC.
- 6 During the process of pairing the meter with a PC enter PIN code compatible with the PIN code of the meter defined in main settings.
- 7 On the computer start **Sonel Reader**.





Standard pin for Bluetooth is **1234**. Settings in the meter according to **section 2.2**.

## 5 Troubleshooting

Before sending the instrument for repairs, call our service. Perhaps the meter is not damaged, and the problem has been caused by some other reasons.

The meter can be repaired only at outlets authorized by the manufacturer.

Troubleshooting of typical problems during the use of the meter is described in the table below.

Measurement function	Symptom	Cause	Action
All	The meter will not switch off with the  button.		
	The  symbol appears during voltage measurement.	Discharged or incorrectly placed batteries.	Check if the batteries are placed correctly; replace / charge the batteries. If this has not helped, send the meter for repair.
	The meter switches off during preliminary test.		
	Measurement errors after the meter has been transferred from cold environment to warm and humid one.	No acclimatization.	Do not make measurement until the meter reaches the ambient temperature (about 30 minutes) and dries.
Fault loop	Successive results in the same measurement point are significantly different.	Incorrect connections in the tested installation.	Check and remove the defects.
		Mains with a lot of disturbance or unstable voltage.	Make more measurements, average the results.
	The meter indicates the values close to zero or zero irrespective of the measurement location, and displayed values are significantly different than expected.	Incorrectly chosen test leads in the meter settings.	

## 6 Power supply

### 6.1 Monitoring the power supply voltage

The batteries charging level is indicated by the symbol located in the top right-hand corner of the screen:



Batteries charged.



Batteries discharged.

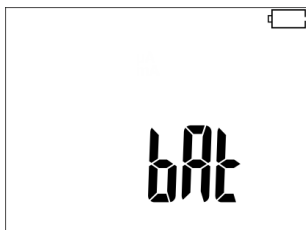

Replace or charge the batteries!

Remember that:

- the **bat** message on the display indicates insufficient power supply voltage and the need to replace or charge the batteries,
- the measurements made with the meter with insufficient power supply voltage have additional measurement error which is impossible to be estimated by the user.

### 6.2 Replacing the batteries

The power supply of the meter is from four LR6 alkaline batteries or four NiMH rechargeable batteries (size AA). The batteries are in a compartment in the bottom part of the casing.



#### WARNING

**Before replacing the batteries, disconnect the test leads from the meter.**

To replace the batteries:

1. Disconnect the leads from the measurement circuit and switch off the meter.
2. Unscrew the bolt fastening the battery compartment cover (in the bottom part of the casing).
3. Replace all batteries. Observe correct polarity when putting new batteries ("+" at the spring part of the contact plate). Reversed polarity of the batteries will not damage the meter or the batteries, but the meter will not work.
4. Put the cover in place and fasten it with the bolt.



#### NOTE!

- After replacement of batteries, **set the power supply type in the main menu** because correct charging level indication depends on this. Discharging characteristics of batteries and rechargeable batteries are different.
- If batteries leak in the compartment, send the meter to the service outlet.

Rechargeable batteries should be charged in an external charger.

### 6.3 General rules of using the Nickel Metal Hydride (Ni-MH) batteries

- If you are not going to use the instrument for a longer time, remove the rechargeable batteries and store them separately.
- Store the rechargeable batteries in a dry, cool and well ventilated place and protect them from direct sunlight. The long storage temperature should be below 30°C. If the batteries are stored long at high temperatures, the chemical processes may reduce their life.
- The NiMH rechargeable batteries usually withstand 500-1000 charging cycles. Such batteries achieve full capacity after forming (2-3 discharging and charging cycles). The most important factor which influences the battery life is the discharge level. The deeper the discharge level, the shorter the battery life.
- The memory effect appears in the NiMH batteries in a limited scope. These batteries can be re-charged without more serious consequences. It is, however, recommended to discharge them completely every few cycles.
- During the storage of the Ni-MH rechargeable batteries, they are subject to self-discharge process at the rate of about 30% a month. Keeping the batteries at high temperatures may accelerate this process even two times. In order not to allow an excessive discharging of the batteries (after which the forming will be needed), recharge the batteries once in a while (even unused batteries).
- Modern, fast chargers detect too low and too high temperature of the batteries and respond accordingly. If the temperature is too low, the charging process should not start as it might irrevocably damage a rechargeable battery. The battery temperature increase is a signal to stop the charging and is typical. In addition to faster temperature increase of a battery which will not be fully charged, charging at high ambient temperatures results, however, in a reduced life.
- Remember that with fast charging, the batteries are charged to about 80% of their capacity; better results can be achieved by continuing the charging process: the charger then goes into the small current charging mode and after a few hours the batteries are fully charged.
- Do not charge and do not use the batteries at extreme temperatures as they reduce the life of batteries. Avoid using the battery-powered devices in very hot places. The rated operating temperature must be observed at all times.

## 7 Cleaning and maintenance



### NOTE!

Use only the maintenance methods presented by the manufacturer in this manual.

Clean the meter casing and the case with a wet cloth, using generally available detergents. Do not use any solvents and cleaning media which could scratch the casing (powder, paste, etc.).

The probes can be cleaned with water and then wiped dry. Before longer storage, it is recommended to lubricate the probes with any machine grease.

Clean the leads with water and detergents, then wipe dry.

The meter electronic system is maintenance free.

## 8 Storage

When storing the instrument, observe the following recommendations:

- disconnect all leads from the meter,
- thoroughly clean the meter and all accessories,
- if you are not going to use the instrument for a longer time, remove the batteries,
- during a prolonged storage recharge the batteries from time to time to prevent total discharging.

## 9 Dismantling and disposal

Used electric and electronic equipment should be collected selectively, i.e. not placed with other types of waste.

Used electronic equipment shall be sent to the collection point according to the Used Electric and Electronic Equipment Act.

Before sending the instrument to the collection point, do not dismantle any parts by yourself. Observe local regulations on disposal of packagings and used batteries.

## 10 Technical data

### 10.1 Basic information

⇒ “m.v.” abbreviation in determination of accuracy means a standard measured value.

#### 10.1.1 Voltage measurement

Range	Resolution	Accuracy
0.0...299.9 V	0.1 V	±(2% m.v. + 6 digits)
300...500 V	1 V	±(2% m.v. + 2 digits)

- Frequency range: 45...65 Hz

#### 10.1.2 Frequency measurement

Range	Resolution	Accuracy
45.0...65.0 Hz	0.1 Hz	±(0,1% m.v. + 1 digit)

- Voltage distribution: 50...500 V

#### 10.1.3 $Z_{L-PE}$ , $Z_{L-N}$ , $Z_{L-L}$ fault loop impedance measurement

##### $Z_S$ fault loop impedance measurement

Measurement range according to IEC 61557:

Test lead	Measurement range $Z_S$
1.2 m WS-07	0.13...1999 $\Omega$
5 m	0.17...1999 $\Omega$
10 m	0.21...1999 $\Omega$
20 m	0.29...1999 $\Omega$
WS-03 WS-04 WS-05	0.19...1999 $\Omega$

Display ranges:

Display range	Resolution	Accuracy
0...19.99 $\Omega$	0.01 $\Omega$	±(5% m.v. + 3 digits)
20.0...199.9 $\Omega$	0.1 $\Omega$	±(5% m.v. + 3 digits)
200...1999 $\Omega$	1 $\Omega$	±(5% m.v. + 3 digits)

- Rated operating voltage  $U_{nL-N}$  /  $U_{nL-L}$ : 220/380 V, 230/400 V, 240/415 V
- Voltage operating range: 180...270 V (for  $Z_{L-PE}$  and  $Z_{L-N}$ ) and 180...460 V (for  $Z_{L-L}$ )
- Mains rated frequency  $f_n$ : 50 Hz, 60 Hz
- Frequency operating range: 45...65 Hz
- Maximum test current: 7.6 A for 230 V (4x10 ms), 13.3 A for 400 V (4x10 ms)
- Check of PE terminal connection correctness with the contact electrode (for  $Z_{L-PE}$ )

##### Readings of fault loop impedance $R_S$ and fault loop reactance $X_S$

Display range	Resolution	Accuracy
0...19.99 $\Omega$	0.01 $\Omega$	±(5% + 5 digits) of $Z_S$ value
20.0...199.9 $\Omega$	0.1 $\Omega$	±(5% + 5 digits) of $Z_S$ value

- Calculated and displayed values  $Z_S < 200 \Omega$

### Readings of short-circuit current $I_k$

Measurement ranges according to IEC 61557 can be calculated from the measurement ranges  $Z_S$  and rated voltages.

Display range	Resolution	Accuracy
0.110...1.999 A	0.001 A	Calculated on the basis of accuracy for the fault loop
2.00...19.99 A	0.01 A	
20.0...199.9 A	0.1 A	
200...9999 A	1 A	

- Prospective fault current calculated and displayed by the meter may slightly differ from the value calculated by the user with a calculator, basing on the displayed value of the impedance, because the meter calculates the current from unrounded value of fault loop impedance (which is used for displaying). As the correct value, consider  $I_k$  current value, displayed by the meter or by firmware.

## 10.1.4 $Z_{L-PE}$ fault loop impedance measurement **RCD** (without tripping the RCD)

### $Z_S$ fault loop impedance measurement

Measurement range according to IEC 61557: 0.5...1999  $\Omega$  for the 1.2 m leads, WS-03, WS-04, WS-05 and WS-07, and 0.51...1999  $\Omega$  for the 5 m, 10 m and 20 m leads

Display range	Resolution	Accuracy
0...19.99 $\Omega$	0.01 $\Omega$	$\pm(6\% \text{ m.v.} + 10 \text{ digits})$
20.0...199.9 $\Omega$	0.1 $\Omega$	$\pm(6\% \text{ m.v.} + 5 \text{ digits})$
200...1999 $\Omega$	1 $\Omega$	$\pm(6\% \text{ m.v.} + 5 \text{ digits})$

- Does not trip the RCD's with  $I_{\Delta n} \geq 30 \text{ mA}$
- Rated operating voltage  $U_n$ : 220 V, 230 V, 240 V
- Voltage operating range: 180...270 V
- Mains rated frequency  $f_n$ : 50 Hz, 60 Hz
- Frequency operating range: 45...65 Hz
- Check of PE terminal connection correctness with the contact electrode

### Readings of fault loop impedance $R_S$ and fault loop reactance $X_S$

Display range	Resolution	Accuracy
0...19.99 $\Omega$	0.01 $\Omega$	$\pm(6\% + 10 \text{ digits})$ of $Z_S$ value
20.0...199.9 $\Omega$	0.1 $\Omega$	$\pm(6\% + 5 \text{ digits})$ of $Z_S$ value

- Calculated and displayed values  $Z_S < 200 \Omega$

### Readings of short-circuit current $I_k$

Measurement ranges according to IEC 61557 can be calculated from the measurement ranges  $Z_S$  and rated voltages.

Display range	Resolution	Accuracy
0.110...1.999 A	0.001 A	Calculated on the basis of accuracy for the fault loop
2.00...19.99 A	0.01 A	
20.0...199.9 A	0.1 A	
200...9999 A	1 A	

- Prospective fault current calculated and displayed by the meter may slightly differ from the value calculated by the user with a calculator, basing on the displayed value of the impedance, because the meter calculates the current from unrounded value of fault loop impedance (which is used for displaying). As the correct value, consider  $I_k$  current value, displayed by the meter or by firmware.



## 10.1.5 Low-voltage continuity and resistance measurement

### Continuity measurements of protective conductors and equipotential bonding with the $\pm 200$ mA current

Measurement range according to IEC 61557-4: 0.12...400  $\Omega$

Range	Resolution	Accuracy
0.00...19.99 $\Omega$	0.01 $\Omega$	$\pm(2\% \text{ m.v.} + 3 \text{ digits})$
20.0...199.9 $\Omega$	0.1 $\Omega$	
200...400 $\Omega$	1 $\Omega$	

- Voltage on open terminals: 4...20 V
- Output current at  $R < 2 \Omega$ : min 200 mA ( $I_{SC}$ : 200...250 mA)
- Test leads resistance compensation
- Measurements for both current polarities

### Low-current resistance measurement

Range	Resolution	Accuracy
0.0...199.9 $\Omega$	0.1 $\Omega$	$\pm(3\% \text{ m.v.} + 3 \text{ digits})$
200...1999 $\Omega$	1 $\Omega$	

- Voltage on open terminals: 4...20 V
- Short-circuit current  $I_{SC}$ : 8...15 mA
- Audio signal for measured resistance  $< 30 \Omega \pm 50\%$
- Test leads resistance compensation

## 10.2 Other technical specifications

- a) Insulation type according to EN 61010-1 and IEC 61557 .....double
- b) Measurement category according to EN 61010-1 ..... IV 300 V (III 600 V)
- c) casing protection rating according to EN 60529 ..... IP67
- d) meter power supply .....LR6 alkaline batteries or AA size NiMH rechargeable batteries (4 pcs)
- e) dimensions ..... 220 x 102 x 61 mm
- f) weight ..... ca. 0.8 kg
- g) storage temperature ..... -20...+70°C
- h) operating temperature ..... 0...+50°C
- i) humidity ..... 20...90%
- j) reference temperature ..... +23  $\pm$  2°C
- k) reference humidity ..... 40...60%
- l) altitude (above sea level) .....  $\leq 2000 \text{ m}^*$
- m) time to Auto-OFF ..... 300, 600, 900 seconds or none
- n) number of Z measurements (for rechargeable batteries) ..... >5000 (2 measurements / minute)
- o) display ..... LCD segment
- p) measurement results memory ..... 990 cells, 10 000 entries
- q) transmission of results ..... Bluetooth
- r) quality standard ..... development, design and manufacture acc. to ISO 9001, ISO 14001, ISO 45001
- s) instrument conforming to ..... IEC 61557
- t) product meets the EMC requirements (resistance for industrial environments) according to the standards ..... EN 61326-1 and EN 61326-2-2



SONEL S.A. hereby declares that the radio device type MZC-304F complies with Directive 2014/53/EU. The full text of the EU Declaration of Conformity is available at the following website address: <https://sonel.pl/en/download/declaration-of-conformity/>

### 10.3 Additional information

Information about additional uncertainty is useful mainly when the meter is used in untypical conditions and for the measurements laboratories during calibration.

#### 10.3.1 Additional uncertainty according to IEC 61557-3 (Z)

Influencing value	Designation	Additional uncertainty
Location	E <sub>1</sub>	0%
Supply voltage	E <sub>2</sub>	0% ( <b>BAT</b> is not displayed)
Temperature 0...35°C	E <sub>3</sub>	1.2 m, WS-07 lead – 0 Ω 5 m lead – 0.011 Ω 10 m lead – 0.019 Ω 20 m lead – 0.035 Ω WS-03, WS-04, WS-05 leads – 0.015 Ω
Phase angle 0...30° at the bottom of measurement range	E <sub>6.2</sub>	0.6%
Frequency 99%...101%	E <sub>7</sub>	0%
Mains voltage 85%...110%	E <sub>8</sub>	0%
Harmonics	E <sub>9</sub>	0%
DC component	E <sub>10</sub>	0%

#### 10.3.2 Additional uncertainty according to IEC 61557-4 (R ±200 mA)

Influencing value	Designation	Additional uncertainty
Location	E <sub>1</sub>	0%
Supply voltage	E <sub>2</sub>	0,5% ( <b>BAT</b> is not displayed)
Temperature 0...35°C	E <sub>3</sub>	1,5%

## 11 Manufacturer

The manufacturer of the equipment and provider of service during and past the warranty period:

**SONEL S.A.**  
Wokulskiego 11  
58-100 Świdnica  
Poland  
tel. +48 74 884 10 53 (Customer Service)  
e-mail: [customerservice@sonel.com](mailto:customerservice@sonel.com)  
web page: [www.sonel.com](http://www.sonel.com)



#### NOTE!

Service repairs must be performed solely by the manufacturer.

## MEASUREMENT MESSAGES



### NOTE!

The meter is designed for operation at rated phase voltages of 220 V, 230 V and 240 V and phase-to-phase voltages of 380 V, 400 V, 415 V.

Connecting voltage higher than allowed between any of the test terminals may damage the meter and cause a hazard to the user.

### Measurements

**NOISE!**

Interference voltage occurs on the tested object. Measurement is possible but may be burdened with additional uncertainty.

**READY**

The meter is ready for measurement.



Maximum temperature of the meter is exceeded. The measurement is blocked.



Phase connected to N terminal instead of L terminal (for example, exchange of L and N in the mains socket).

---E no

An incompatible measurement adapter is connected to the meter.

E00

Short-circuit loop of the meter is faulty.

Err

Error during measurement.

ErrU

Error during the measurement: loss of voltage after the measurement.

L-n

Voltage on terminals L and N is not within measurable range.

L-PE

Voltage on terminals L and PE is not within measurable range.

Ub

Safe contact voltage exceeded.

UdEt

The tested facility is live. The measurement is blocked. **Immediately disconnect the meter from the object (both test leads).**

ULn

Error in connection of N conductor.

### Battery / rechargeable battery status



Charged.



Discharged.

bAt

Completely discharged. Replace or recharge the batteries.



**SONEL S.A.**

Wokulskiego 11  
58-100 Świdnica  
Poland

**Customer Service**

tel. +48 74 884 10 53  
e-mail: [customerservice@sonel.com](mailto:customerservice@sonel.com)

[www.sonel.com](http://www.sonel.com)