



# User Guide

4G+ Cat6 AC1200 Wireless  
Dual Band Gigabit Router

# Contents

About This Guide .....	1
<b>Chapter 1. Get to Know Your 4G LTE Router .....</b>	<b>2</b>
1. 1. Product Overview.....	3
1. 2. Panel Layout.....	3
1. 2. 1.Top View .....	3
1. 2. 2.The Back Panel.....	4
<b>Chapter 2. Connect the Hardware .....</b>	<b>6</b>
2. 1. Requirements for Operation .....	7
2. 2. Position Your 4G LTE Router.....	7
2. 3. Connect Your 4G LTE Router.....	8
<b>Chapter 3. Log In to Your 4G LTE Router .....</b>	<b>10</b>
<b>Chapter 4. Set Up Internet Connections.....</b>	<b>12</b>
4. 1. Use Quick Setup Wizard .....	13
4. 2. Create a Connection Profile.....	13
4. 3. Set Up IPv6 Tunnel.....	15
4. 3. 1.Use the Public IPv6 Tunnel Service-6to4.....	15
4. 3. 2.Specify the 6rd Tunnel with Parameters Provided by Your ISP .....	16
4. 4. Test Internet Connectivity .....	16
<b>Chapter 5. QoS.....</b>	<b>18</b>
<b>Chapter 6. Network Security .....</b>	<b>21</b>
6. 1. Protect the Network from Cyber Attacks.....	22
6. 2. Service Filtering .....	23
6. 3. Access Control .....	24
6. 4. IP & MAC Binding .....	25
6. 5. IPv6 Firewall .....	26
<b>Chapter 7. Parental Controls .....</b>	<b>28</b>
<b>Chapter 8. SMS .....</b>	<b>32</b>

8. 1.	View Messages .....	33
8. 2.	Edit and Send a New Message .....	33
8. 3.	View Sent Messages.....	34
8. 4.	View Drafts .....	34
8. 5.	SMS Settings .....	34

## **Chapter 9. Guest Network..... 36**

9. 1.	Create a Network for Guests .....	37
9. 2.	Customize Guest Network Options.....	37

## **Chapter 10.NAT Forwarding..... 39**

10. 1.	Translate Address and Port by ALG.....	40
10. 2.	Share Local Resources in the Internet by Virtual Server.....	40
10. 3.	Open Ports Dynamically by Port Triggering.....	42
10. 4.	Make Applications Free from Port Restriction by DMZ .....	43
10. 5.	Make Xbox Online Games Run Smoothly by UPnP .....	45

## **Chapter 11.Specify Your Network Settings..... 46**

11. 1.	Upgrade Your ISP Information.....	47
11. 2.	PIN Management .....	47
11. 3.	Data Settings .....	48
11. 4.	LAN Settings .....	49
	11. 4. 1.Change the LAN IP Address.....	49
	11. 4. 2.Use the 4G LTE Router as a DHCP Server.....	50
	11. 4. 3.Reserve LAN IP Addresses.....	51
11. 5.	Wireless Settings.....	52
	11. 5. 1.Specify Basic Wireless Settings.....	52
	11. 5. 2.Use WPS for Wireless Connection.....	54
	11. 5. 3.Schedule Your Wireless Function.....	55
	11. 5. 4.View Wireless Information.....	56
	11. 5. 5.Advanced Wireless Settings .....	57
11. 6.	Set Up a Dynamic DNS Service Account .....	58
11. 7.	Create Static Routes.....	60
11. 8.	Set up a VPN Connection .....	61
	11. 8. 1.Use OpenVPN to Access Your Home Network .....	62
	11. 8. 2.Use PPTP VPN to Access Your Home Network.....	63
11. 9.	USSD.....	67

## **Chapter 12.Administrate Your Network ..... 68**

12. 1. Set System Time .....	69
12. 2. Control LEDs .....	70
12. 3. Test the Network Connectivity .....	70
12. 4. Update the Firmware.....	71
12. 4. 1.Online Upgrade .....	71
12. 4. 2.Local Upgrade .....	72
12. 5. Back up and Restore Configuration Settings .....	72
12. 6. Set the Router to Reboot Regularly.....	73
12. 7. Change the Administrator Account.....	74
12. 8. Local Management .....	75
12. 9. Remote Management.....	76
12. 10. System Log.....	77
12. 11. CWMP Settings.....	79
12. 12. SNMP Settings .....	80
12. 13. Monitor the Internet Traffic Statistics.....	82
<b>Chapter 13.TP-Link Cloud Service .....</b>	<b>83</b>
13. 1. Register a TP-Link ID.....	84
13. 2. Change Your TP-Link ID Information.....	84
13. 3. Manage the User TP-Link IDs .....	85
13. 3. 1.Add TP-Link ID to Manage the Router .....	86
13. 3. 2.Remove TP-Link ID(s) from Managing the Router .....	86
13. 4. Manage the Router via the TP-Link Tether App .....	87
<b>Chapter 14.OneMesh with Seamless Roaming .....</b>	<b>88</b>
14. 1. Set Up a OneMesh Network.....	90
14. 2. Manage Devices in the OneMesh Network .....	91
<b>FAQ.....</b>	<b>93</b>





# About This Guide

This guide is a complement to Quick Installation Guide. The Quick Installation Guide instructs you on quick internet setup, and this guide provides details of each function and shows you the way to configure these functions appropriate to your needs.

Note: Features available in this router may vary by model and software version. Router availability may also vary by region or ISP. All images, steps, and descriptions in this guide are only examples and may not reflect your actual router experience.

## Conventions

In this guide the following conventions are used:

Convention	Description
<u>Teal Underlined</u>	Hyperlinks are in teal and underlined. You can click to redirect to a website or a specific section.
Teal	Contents to be emphasized and texts on the web page are in teal, including the menus, items, buttons and so on.
>	The menu structures to show the path to load the corresponding page. For example, <a href="#">Advanced</a> > <a href="#">Wireless</a> > <a href="#">MAC Filtering</a> means the MAC Filtering function page is under the Wireless menu that is located in the Advanced tab.
 <b>Note:</b>	Ignoring this type of note might result in a malfunction or damage to the device.
 <b>Tips:</b>	Indicates important information that helps you make better use of your device.

## More Info

- The latest software, management app and utility are available from the [Download Center](#) at <https://www.tp-link.com/support/>.
- The Quick Installation Guide can be found where you find this guide or inside the package of the router.
- Specifications can be found on the product page at <https://www.tp-link.com>.
- A Community is provided for you to discuss our products at <https://community.tp-link.com>.
- Our Technical Support contact information can be found at the [Contact Technical Support](#) page at <https://www.tp-link.com/support/>.

\* Maximum wireless signal rates are the physical rates derived from IEEE Standard 802.11 specifications. Range, coverage, and maximum quantity of connected devices are based on test results under normal usage conditions. Actual wireless data throughput, wireless coverage, and quantity of connected devices are not guaranteed and will vary as a result of 1) environmental factors, including building materials, physical objects, and obstacles, 2) network conditions, including local interference, volume and density of traffic, product location, network complexity, and network overhead, and 3) client limitations, including rated performance, location, connection quality, and client condition.

## Chapter 1

---

# Get to Know Your 4G LTE Router

---

This chapter introduces what the router can do and shows its appearance.

It contains the following sections:

- [Product Overview](#)
- [Panel Layout](#)

## 1.1. Product Overview

The 4G LTE Router shares the latest generation 4G LTE network with multiple Wi-Fi devices, anywhere you want.

With Ethernet ports and antennas, the router provides wired and wireless access for multiple computers and mobile devices.

With various features and functions, the router is the perfect hub of your home or business network.

## 1.2. Panel Layout





### 1.2.1. Top View



The router's LEDs (view from bottom to top) are located on the front panel. You can check the router's working status by following the LED Explanation table.

### LED Explanation

Name	Status	Indication
⏻ (Power)	On	The system has started up successfully.
	Flashing	The system is starting up or firmware is being upgraded. Do not disconnect or power off the router.
	Off	Power is off.

Name	Status	Indication
 (Internet)	On	The router is connected to the internet.
	Off	There is no internet connection.
4G+ (4G+ network)	On	The LTE-Advanced network is available.
	Off	The LTE-Advanced network is disabled.
 (Wi-Fi)	On	The wireless function is enabled.
	Flashing	WPS connection is in progress. This may take up to 2 minutes.
	Off	The wireless function is disabled.
 (LAN)	On	At least one LAN port is connected to a powered-on device.
	Off	No LAN port is connected to a powered-on device.
 (Signal Strength)	On	Indicates the signal strength the router received from the mobile internet. More lit bars indicate a better signal strength.
	Off	There is no mobile internet signal.

**Note:**

1. If the Internet LED is off, please check your internet connection first. Refer to [Connect Your 4G LTE Router](#) for more information about how to make internet connection correctly. If you have already made a right connection, please contact your ISP to make sure your internet service is available now.
2. If the Signal Strength LED is off, please check your Internet LED first. If your Internet LED is also off, please refer to Note 1. If your Internet LED is on, please relocate the router to a location that receives a strong mobile internet signal, such as near a window.

## 1.2.2. The Back Panel



The following parts (view from left to right) are located on the rear panel.

Item	Description
POWER Port	For connecting the router to power socket via the provided power adapter.
POWER ON/OFF Button	Press this button to power on or off the router.
LAN1, LAN2, LAN3, LAN4/WAN	For connecting to your PCs or other Ethernet network devices. In wireless router mode, the LAN4/WAN port is used for connecting to a Cable/FTTH/DSL device.
WPS/ RESET	To enable the WPS function, press this button about 2 seconds. If you have a WPS-supported device, you can press this button to quickly establish connection between the router and the client device.
	Press and hold this button until the Power LED starts flashing to reset the router to its factory default settings.
Wi-Fi ON/OFF	For turning on/off the Wi-Fi function.
Nano SIM Card Slot	For holding the nano SIM card.
Antennas	Used for data sessions over LTE. Upright them for the best mobile internet signal.

## Chapter 2

---

# Connect the Hardware

---

This chapter contains the following sections:

- [Requirements for Operation](#)
- [Position Your 4G LTE Router](#)
- [Connect Your 4G LTE Router](#)

## 2.1. Requirements for Operation

To connect and use the router for internet sharing, you must have the following:

- Nano SIM card with internet access enabled.
- PC with an active Ethernet Adapter and an Ethernet cable with RJ45 connectors.
- Web browser, such as Microsoft Internet Explorer, Mozilla Firefox and Apple Safari.

## 2.2. Position Your 4G LTE Router

With the router, you can access your network from anywhere within the wireless network coverage. However, the wireless signal strength and coverage varies depending on the actual environment where your router is in. Many obstacles may limit the range of the wireless signal, for example, concrete structures, thickness and number of walls.

For your security and best Wi-Fi performance, please:

- Do not locate the router in the place where it will be exposed to moisture or excessive heat.
- Keep away from strong electromagnetic radiation source and electromagnetic-sensitive devices.
- Place the router in a location where it can be connected to the various devices as well as to a power source.
- Place the router in a location where it can receive a strong mobile internet signal.
- Make sure the cables and power cord are safely placed out of the way so they do not create a tripping hazard.

Generally, the router is placed on a horizontal surface, such as on a shelf or desktop.

The device also can be mounted on the wall as shown in the following figure.

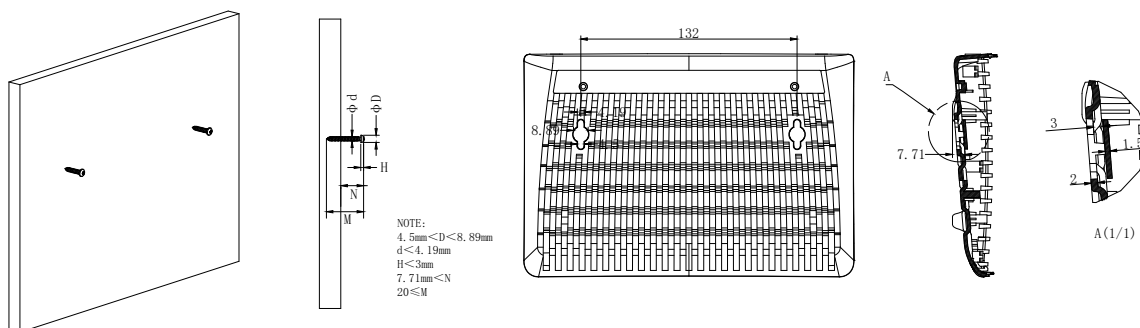

**Note:**

The diameter of the screw,  $4.5\text{mm} < D < 8.89\text{mm}$ . The distance of two screws is 132 mm. The screw that project from the wall need around 7.71 mm based, and the length of the screw need to be at least 20 mm to withstand the weight of the product.

## 2.3. Connect Your 4G LTE Router

Follow the steps below to connect your router.

1. Install the antennas and position them upwards.

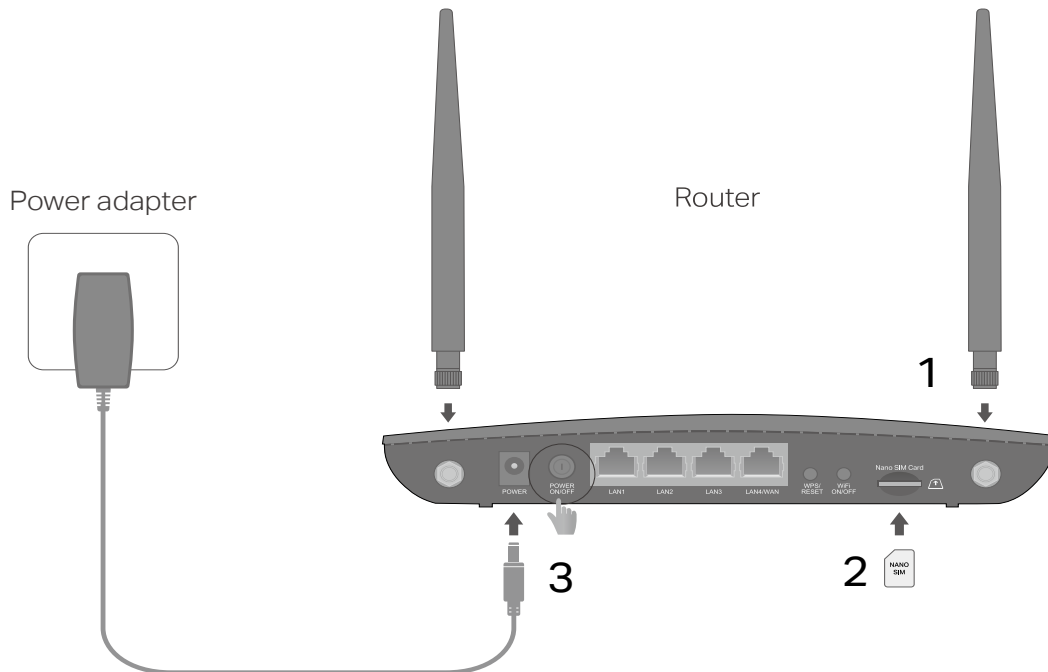

2. With the gold contacts facing down, insert the nano SIM card into the slot until you hear a click.
3. Connect the power adapter and push in the POWER ON/OFF button to turn on the router. The power source shall be near the device and shall be easily accessible.
4. Connect your computer to the router.

### Method 1: Wired

Connect your computer's Ethernet port to one of the LAN ports on the router via an Ethernet cable.

### Method 2: Wirelessly

Use the default SSID (Wireless Network Name) and Wireless Password printed on the product label of the router to connect wirelessly.

### Method 3: Use the WPS button

Wireless devices that support WPS, including Android phones, tablets, most USB network cards, can be connected to your router through this method. (WPS is not supported by iOS devices.)

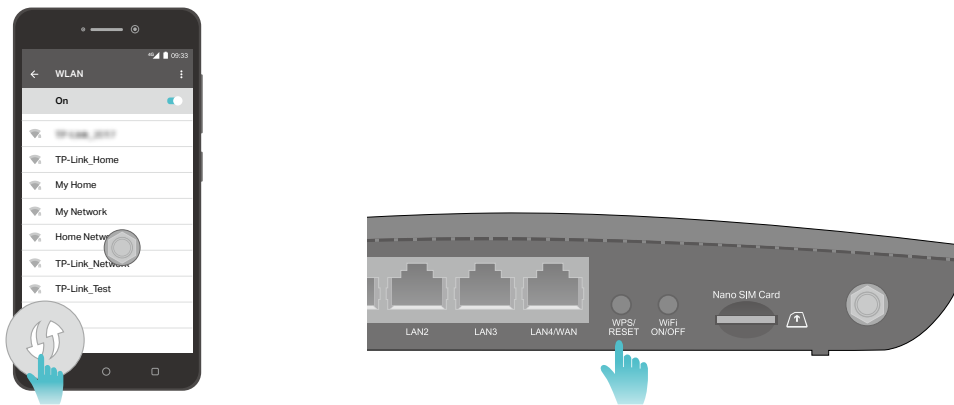

**Note:**

The WPS function cannot be configured if the wireless function of the router is disabled. Also, the WPS function will be disabled if your wireless encryption is WEP. Please make sure the wireless function is enabled and is configured with the appropriate encryption before configuring the WPS.

- 1) Tap the WPS icon on the device's screen.
- 2) Immediately press the WPS button on your router.
- 3) The Wi-Fi LED flashes for about 2 minutes during the WPS process.
- 4) When the Wi-Fi LED is on, the client device has successfully connected to the router.

## Chapter 3

---

# Log In to Your 4G LTE Router

---

With a web management page, it is easy to configure and manage the 4G LTE Router. The web management page can be used on any Windows, Macintosh or UNIX OS with a Web browser, such as Microsoft Internet Explorer, Mozilla Firefox or Apple Safari.

Follow the steps below to log in to your router.

1. If the TCP/IP Protocol on your computer is set to the static (fixed) IP address, you need to change its settings to obtain an IP address automatically. Refer to [FAQ](#) to configure your computer.
2. Launch a web browser and type in <http://tplinkmodem.net> or <http://192.168.1.1>. Set a strong password using 1-32 characters and click **Let's Get Started**.

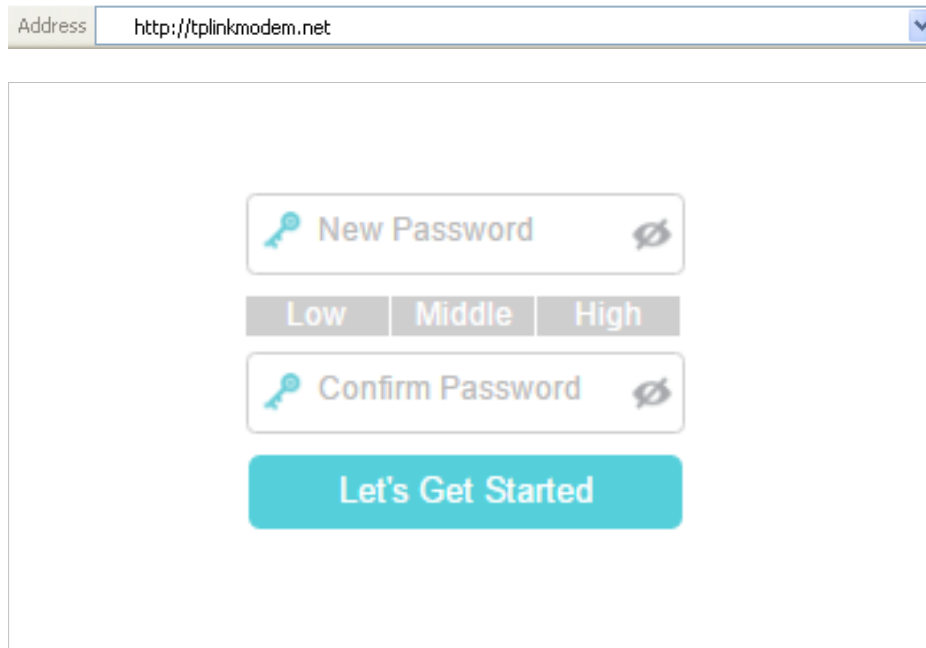

The screenshot shows a web browser address bar with the URL `http://tplinkmodem.net`. Below the address bar is a form for creating a new password. The form includes a text input field labeled "New Password" with a key icon and a toggle for visibility. Below this field are three radio buttons labeled "Low", "Middle", and "High" for password strength selection. Below the strength selection is another text input field labeled "Confirm Password" with a key icon and a toggle for visibility. At the bottom of the form is a large teal button labeled "Let's Get Started".

■ Note: For subsequent logins, use your password that you have created.

## Chapter 4

---

# Set Up Internet Connections

---

This chapter introduces how to connect your router to the internet. The router is equipped with a web-based Quick Setup wizard. It has many ISP information built in, automates many of the steps and verifies that those steps have been successfully completed. Furthermore, you can set up IPv6 connection if your ISP provides IPv6 service.

This chapter includes the following sections:

- [Use Quick Setup Wizard](#)
- [Create a Connection Profile](#)
- [Set Up IPv6 Tunnel](#)
- [Test Internet Connectivity](#)

## 4.1. Use Quick Setup Wizard

To set up your router with several easy steps quickly:

1. Visit <http://tplinkmodem.net>, and log in with the password or your TP-Link ID.
2. Click **Quick Setup**, after configuring your time zone, confirm the parameters with the information provided by your ISP in the **SIM** part and click **Next**.

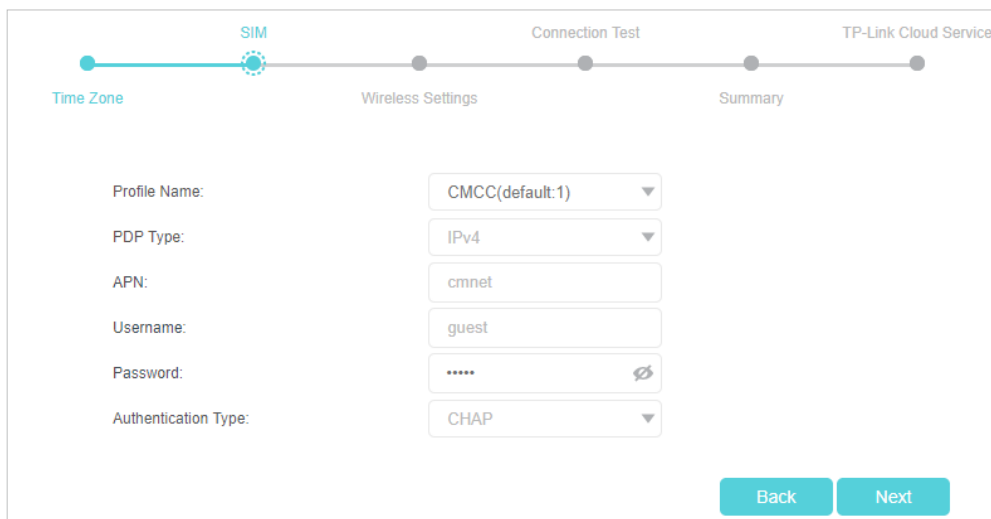

The screenshot shows a progress bar at the top with five steps: Time Zone, SIM, Wireless Settings, Connection Test, and TP-Link Cloud Service. The SIM step is currently active and highlighted in blue. Below the progress bar, the SIM configuration form includes the following fields:

Profile Name:	CMCC(default:1) ▼
PDP Type:	IPv4 ▼
APN:	cmnet
Username:	guest
Password:	..... 🔍
Authentication Type:	CHAP ▼

At the bottom right of the form, there are two buttons: **Back** and **Next**.

▮ **Note:**

1. Quick Setup is not available if your SIM card is locked. Unlock your SIM card according to the prompt.
2. It is recommended to enable **Smart Connect** to enjoy a seamless connection between dual-band networks. With Smart Connect enabled, the router's 2.4GHz and 5GHz share the same SSID (network name) and password.

### 3. Follow the on-screen instructions to complete the setup.

▮ **Note:**

1. During the quick setup process, you can change the preset wireless network name (SSID) and wireless password. Once done, all your wireless devices must use the new SSID and password to connect to the router.
2. The router supports two operation modes, 3G/4G Router Mode and Wireless Router mode. If you already have a modem or your internet comes via an Ethernet cable from the wall, you can set up the router as a regular wireless router to share the internet. Refer to [FAQ > Q6](#) for details.

## 4.2. Create a Connection Profile

If your ISP settings are not detected by the router, you can create an internet connection profile by following the steps below:

1. Visit <http://tplinkmodem.net>, and log in with the password or your TP-Link ID.
2. Go to **Advanced > Network > Internet** page.

WAN Interface
?

---

Internet Status: Disconnected

Mobile Data:

Data Roaming:

NAT:

Network Mode: 4G Preferred ▼

Band: Auto ▼

**Dial-up Settings**

Network Search: Auto ▼

Profile Name: China Unicom(default:1) ▼

PDP Type: IPv4 ▼

APN: 3gnet

Username:

Password:  ✖

Authentication Type: CHAP ▼

[Create Profile](#) Click this button to create a new dial-up profile. Up to 8 profiles can be added.

Delete
Save

**Tips:**

- You can also upgrade the supported ISP information. Refer to [Upgrade Your ISP Information](#) to configure.
- You can view all internet connections or edit connections that are set up manually on this page.
- You can change the [Network Mode](#) to [4G preferred](#), [4G Only](#) or [3G Only](#) according to your needs.
- You can manually select 4G bands in [Band](#) setting.
- If the [Auto](#) network connection displays a wrong ISP profile, you can select a correct network manually:
  1. Change the [Network Search](#) mode to [Manual](#).
  2. When prompted, select the correct ISP network and click [Save](#).

**3. Click [Create Profile](#).**

- 4. Specify the [Profile Name](#), [Username](#) and [Password](#). Select the [PDP Type](#), [APN Type](#) and [Authentication Type](#) according to your ISP.**

Create Profile

---

Profile Name:

PDP Type: IPv4 ▼

APN Type: Dynamic ▼

Username:

Password:  ✖

Authentication Type: CHAP ▼

Cancel
OK

5. Click **OK** to make the settings effective and the new profile will be used to set up a new connection.

## 4.3. Set Up IPv6 Tunnel

The IPv6 Tunnel feature helps you obtain IPv6 resources based on an IPv4 WAN connection or vice versa.

IPv6 Tunnel is a transition mechanism that allows isolated IPv6 hosts and networks to reach each other over IPv4-only infrastructure before IPv6 completely supplants IPv4. It is a temporary solution for networks that do not support native dual-stack, where both IPv6 and IPv4 run independently.

The router provides three tunneling mechanisms: **6to4**, **6rd** and **DS-Lite**. The way to set up 6rd and DS-Lite tunnel are similar.

### Note:

You must reconfigure the IPv6 Tunnel settings every time you reboot the router. Make sure the desired WAN connection is connected before the configuration.

### 4.3.1. Use the Public IPv6 Tunnel Service-6to4

The 6to4 tunnel is a kind of public service. If there are any 6to4 servers on your network, you can use this mechanism to access IPv6 service. If your ISP provides you with an IPv4-only connection but you want to visit IPv6 websites, you can try to set up a 6to4 tunnel.

### I want to:

Set up the IPv6 tunnel though my ISP doesn't provide me with the tunnel service.

### How can I do that?

1. Visit <http://tplinkmodem.net>, and log in with the password you set for the router.
2. Go to **Advanced > Network > IPv6 Tunnel**.
3. Tick the check box, select **6to4** as the tunneling mechanism and select a WAN connection from the drop-down list, then click **Save**.

IPv6 Tunnel

Note: You must reconfigure the IPv6 Tunnel settings every time you reboot the router. Make sure the desired WAN connection is connected before the configuration.

IPv6 Tunnel:  Enable

Tunneling Mechanism: 6to4

WAN Connection: LTE

Save

### Note:

If there is no available WAN connection to choose, make sure you have connected to the internet.

## Done!

Now you can visit the IPv6 websites with the 6to4 tunnel.

**Note:** Still not being able to access IPv6 resources means that not any 6to4 public server was found in your network. You can contact your ISP to sign up for IPv6 connection service.

### 4.3.2. Specify the 6rd Tunnel with Parameters Provided by Your ISP

#### I want to:

Specify the 6rd tunnel with the parameters provided by my 6rd tunnel service provider.

#### How can I do that?

1. Visit <http://tplinkmodem.net>, and log in with the password you set for the router.
2. Go to [Advanced > Network > IPv6 Tunnel](#).
3. Tick the check box, select [6rd](#) as the tunneling mechanism and select a WAN connection from the drop-down list.
4. According to the parameters provided by your ISP, choose [Auto](#) or [Manual](#). More parameters are needed if you choose [Manual](#).
5. Click [Save](#).

**Note:**

If there is no available WAN connection to choose, make sure you have connected to the internet and the connection type is not Bridge.

## Done!

Now you can visit the IPv6 websites with the 6rd tunnel.

**Tips:** The way to set up DS-Lite tunnel is similar to that of 6rd tunnel. If you are provided with an IPv6-only WAN connection and have signed up for DS-Lite tunnel service, specify the DS-Lite tunnel by referring to the steps above.

## 4.4. Test Internet Connectivity

After manually set up the internet connection, you need to know the internet connectivity. The router provides a diagnostic tool to help you locate the malfunction.



1. Visit <http://tplinkmodem.net>, and log in with the password or your TP-Link ID.
2. Go to [Advanced](#) > [System Tools](#) > [Diagnostics](#) page.

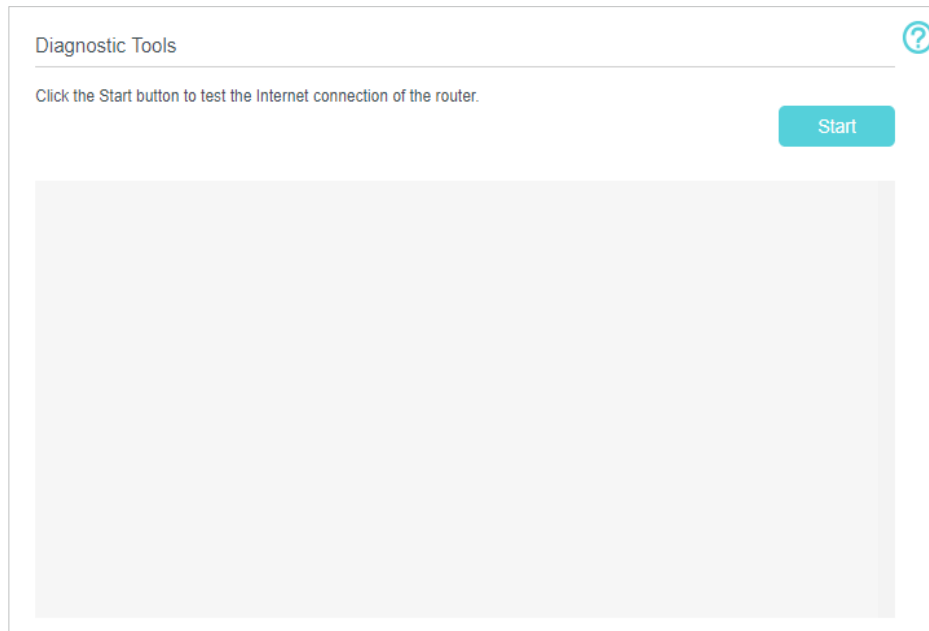

3. Click [Start](#) to test the internet connectivity and you will see the test result in the gray box.

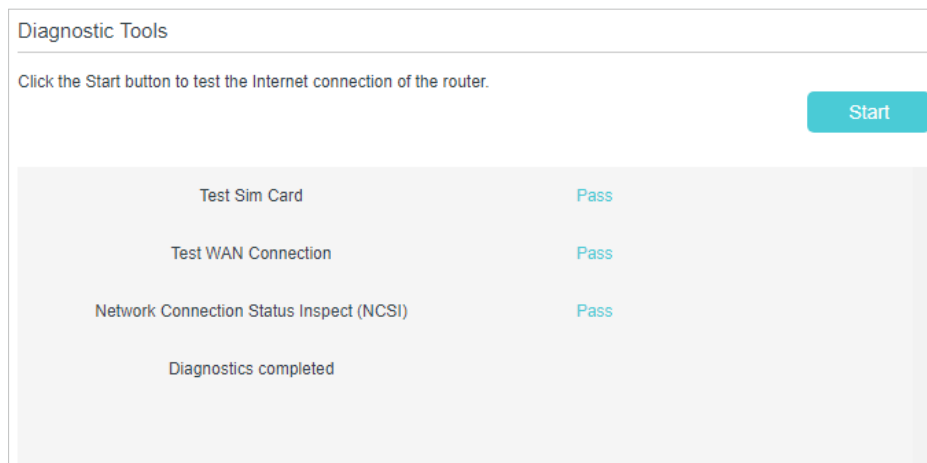

## Chapter 5

---

# QoS

---

This chapter introduces how to create a QoS (Quality of Service) rule to specify prioritization of traffic and minimize the impact caused when the connection is under heavy load.

## I want to:

Specify priority levels for some devices or applications.

For example, I have several devices that are connected to my wireless network. I would like to set an intermediate speed on the internet for my phone.

## How can I do that?

1. Enable QoS and set bandwidth allocation.

1) Visit <http://tplinkmodem.net>, and log in with the password or your TP-Link ID.

2) Go to **Advanced > QoS > Settings**.

3) Select **Enable QoS**.

 Note:

1. QoS and NAT Boost cannot be enabled at the same time. To disable NAT Boost, go to **Advanced > NAT Forwarding > NAT Boost**, unclick it and save your settings.

2. NAT Boost ensure that the router has the best throughput. When NAT Boost is enabled, QoS and Traffic Monitor will be disabled automatically.

4) Input the maximum upload and download bandwidth provided by your Internet service provider. 1Mbps equal s to 1000 Kbps.

5) Click **Advanced** and drag the scroll bar to set the bandwidth priority percentage.

6) Click **Save**.

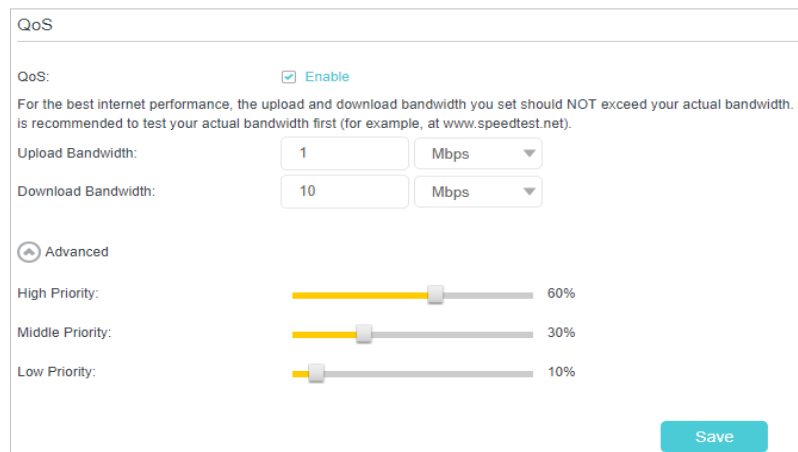

QoS

QoS:  Enable

For the best internet performance, the upload and download bandwidth you set should NOT exceed your actual bandwidth. It is recommended to test your actual bandwidth first (for example, at [www.speedtest.net](http://www.speedtest.net)).

Upload Bandwidth:  Mbps

Download Bandwidth:  Mbps

**Advanced**

High Priority:  60%

Middle Priority:  30%

Low Priority:  10%

**Save**

2. Add a middle priority QoS rule for the phone.

1) Click **Add** in the **Middle Priority: 30%** column.

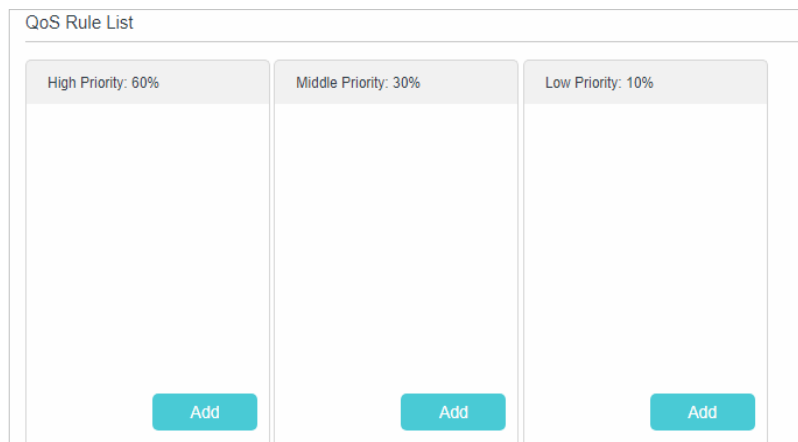

QoS Rule List

High Priority: 60%	Middle Priority: 30%	Low Priority: 10%
<a href="#">Add</a>	<a href="#">Add</a>	<a href="#">Add</a>

- 2) Select [By Device](#) and then click [Scan](#).
- 3) Choose the respective device from the list.
- 4) Click [Save](#).

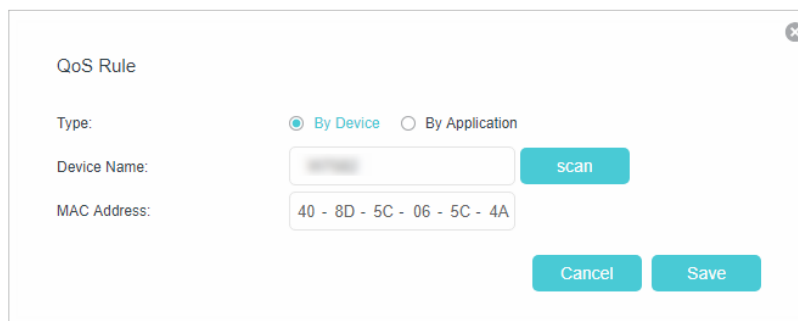

QoS Rule

Type:  By Device  By Application

Device Name:  [scan](#)

MAC Address:

[Cancel](#) [Save](#)

**Note:**

If you want to delete a QoS rule, click  to remove the responding rule from the list.

## Done!

Now QoS is implemented to prioritize internet traffic.

## Chapter 6

---

# Network Security

---

This chapter guides you on how to protect your home network from cyber attacks and unauthorized users by implementing these three network security functions. You can protect your home network against DoS (Denial of Service) attacks from flooding your network with server requests using DoS Protection, block or allow specific client devices to access your network using Access Control, or you can prevent ARP spoofing and ARP attacks using IP & MAC Binding.

- [Protect the Network from Cyber Attacks](#)
- [Service Filtering](#)
- [Access Control](#)
- [IP & MAC Binding](#)
- [IPv6 Firewall](#)

## 6.1. Protect the Network from Cyber Attacks

The SPI Firewall can prevent cyber attacks and validate the traffic that is passing through the router based on the protocol. This function is enabled by default, and it's recommended to keep the default settings.

DoS Protection can protect your home network against DoS attacks from flooding your network with server requests.

Follow the steps below to configure Firewall and DoS Protection.

1. Visit <http://tplinkmodem.net>, and log in with the password or your TP-Link ID.
2. Go to **Advanced > Security > Firewall & DoS Protection**.

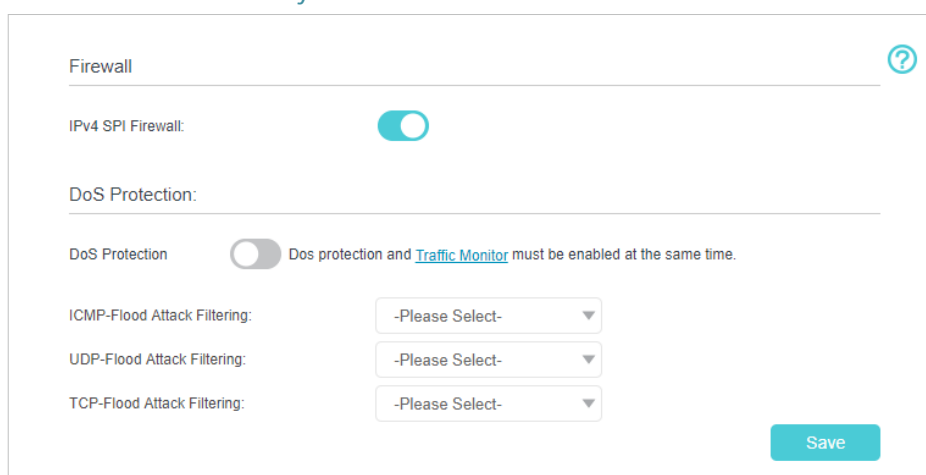

The screenshot shows the 'Firewall' configuration page. At the top, there is a 'Firewall' header with a help icon. Below it, the 'IPv4 SPI Firewall' is shown as a toggle switch that is turned on. Underneath, the 'DoS Protection' section has a toggle switch that is turned off, with a note: 'Dos protection and [Traffic Monitor](#) must be enabled at the same time.' Below this, there are three dropdown menus for 'ICMP-Flood Attack Filtering', 'UDP-Flood Attack Filtering', and 'TCP-Flood Attack Filtering', each currently set to '-Please Select-'. A 'Save' button is located at the bottom right of the configuration area.

3. Enable **IPv4 SPI Firewall**.

4. Enable **DoS Protection**.

**Note:** DoS protection and Traffic Statistics must be enabled at the same time. To enable Traffic Statistics, go to **Advanced>System Tools>Traffic Monitor** and toggle on Traffic Monitor.

5. Set the level (**Low**, **Middle** or **High**) of protection for **ICMP-FLOOD Attack Filtering**, **UDP-FLOOD Attack Filtering** and **TCP-FLOOD Attack Filtering**.
  - **ICMP-FLOOD Attack Filtering** - Enable to prevent the ICMP (Internet Control Message Protocol) flood attack.
  - **UDP-FLOOD Attack Filtering** - Enable to prevent the UDP (User Datagram Protocol) flood attack.
  - **TCP-FLOOD Attack Filtering** - Enable to prevent the TCP-SYN (Transmission Control Protocol-Synchronize) flood attack.

**Tips:**

The level of protection is based on the number of traffic packets. The protection will be triggered immediately when the number of packets exceeds the preset threshold value (the value can be set on [Dos Protection Level Settings](#) section of the same page), and the vicious host will be displayed in the [Blocked DoS Host List](#).

6. Click **Save**.

## 6.2. Service Filtering

With Service Filtering, you can prevent certain users from accessing the specified service, even block Internet access completely.

1. Visit <http://tplinkmodem.net>, and log in with the password or your TP-Link ID.
2. Go to **Advanced > Security > Service Filtering** and enable **Service Filtering**.

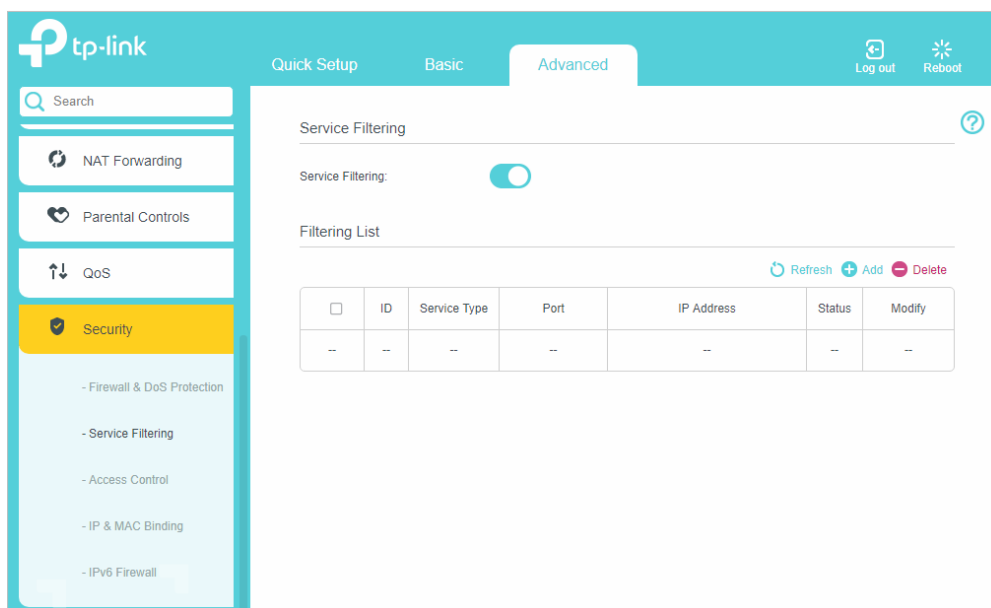

3. Click **Add**.

The screenshot shows the 'Add' dialog box for creating a new service filtering rule. It includes the following fields and options:

- Service Type:** Any(ALL) (dropdown menu)
- Protocol:** TCP/UDP (dropdown menu)
- Starting Port:** 1 (text input, range 1-65535)
- Ending Port:** 65535 (text input, range 1-65535)
- Service Type:** Any(ALL) (text input)
- Filter Service For:**
  - Single IP Address
  - IP Address Range
  - All IP Addresses

Buttons for 'Cancel' and 'Save' are located at the bottom right.

4. Select a service type from the drop-down list and the following four fields will be auto-populated. Select **Custom** when your desired service type is not listed, and enter the information manually.
5. Specify the IP address(es) that this filtering rule will apply to.
6. Click **Save**.

## 6.3. Access Control

Access Control is used to block or allow specific client devices to access your network (via wired or wireless) based on a list of blocked devices (Blacklist) or a list of allowed devices (Whitelist).

### I want to:

Block or allow specific client devices to access my network (via wired or wireless)

### How can I do that?

1. Visit <http://tplinkmodem.net>, and log in with the password or your TP-Link ID.
2. Go to **Advanced > Security > Access Control** and enable **Access Control**.

The screenshot shows the TP-Link web interface for the 'Access Control' settings. The 'Access Control' toggle is currently disabled. The 'Access Mode' is set to 'Blacklist'. Below the settings, there are two tables: 'Devices in Blacklist' and 'Online Devices'. The 'Online Devices' table has one entry with ID 1, IP Address 192.168.1.100, and MAC Address 40-8D-5C-06-5C-4A.

ID	Device Name	MAC Address	Connection Type
1		40-8D-5C-06-5C-4A	Wired

3. Select the access mode to either block (recommended) or allow the device(s) in the list.

#### To block specific device(s)

- 1) Select **Blacklist** and click **Save**.
- 2) Select the device(s) to be blocked in the **Online Devices** table.
- 3) Click **Block** above the **Online Devices** table. The selected devices will be added to **Devices in Blacklist** automatically.

#### To allow specific device(s)

- 1) Select **Whitelist** and click **Save**.
- 2) Click **Add**.



The screenshot shows a web interface titled "Devices in Whitelist". At the top right, there are "+ Add" and "- Delete" buttons. Below this is a table with the following structure:

<input type="checkbox"/>	ID	Device Name	MAC Address	Modify
--	--	--	--	--

Below the table, there are two input fields: "Device Name:" and "MAC Address:". To the right of the "Device Name" field is a "Scan" button. Below the "MAC Address" field are "Cancel" and "Save" buttons.

- 3) Enter the **Device Name** and **MAC Address** (You can copy and paste the information from **Online Devices** table if the device is connected to your network).
- 4) Click **Save**.

**Done!**

Now you can block or allow specific client devices to access your network (via wired or wireless) using the **Blacklist** or **Whitelist**.

## 6.4. IP & MAC Binding

IP & MAC Binding, namely, ARP (Address Resolution Protocol) Binding, is used to bind network device's IP address to its MAC address. This will prevent ARP spoofing and other ARP attacks by denying network access to a device with matching IP address in the Binding list, but unrecognized MAC address.

**I want to:**

Prevent ARP spoofing and other ARP attacks.

**How can I do that?**

1. Visit <http://tplinkmodem.net>, and log in with the password or your TP-Link ID.
2. Go to **Advanced > Security > IP & MAC Binding** and enable **IP & MAC Binding**.

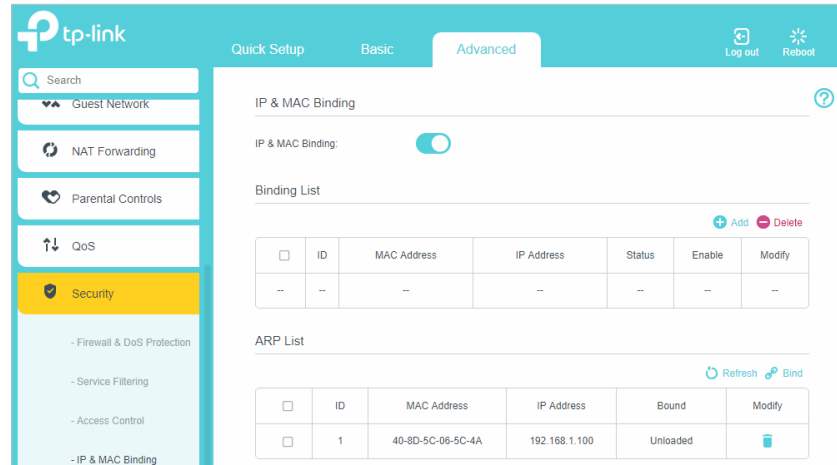

### 3. Bind your device(s) according to your needs.

#### To bind the connected device(s)

- 1) Select the device(s) to be bound in the [ARP List](#).
- 2) Click [Bind](#) to add to the [Binding List](#).

#### To bind the unconnected device

- 1) Click [Add](#).

- 2) Enter the [MAC address](#) and [IP address](#) that you want to bind.
- 3) Select the checkbox to enable the entry and click [Save](#).

## Done!

Now you don't need to worry about ARP spoofing and other ARP attacks.

## 6.5. IPv6 Firewall

IPv6 Firewall protects your IPv6 network by preventing access from the internet. However, when you are hosting a service, such as a file sharing server in your local network, you can choose to allow access to the server from the internet by adding entries on this page. This feature is available only when you've set up an IPv6 connection.

1. Visit <http://tplinkmodem.net>, and log in with your TP-Link ID or the password you set for the router.
2. Go to [Advanced](#) > [Security](#) > [IPv6 Firewall](#).
3. Click [Add](#).

IPv6 Firewall

IPv6 Firewall:

Enable this function if you want to protect IPv6 hosts on your LAN by limiting external access to them. When enabled, only inbound traffic triggered by their outbound traffic is allowed, and you can configure firewall rules to allow additional inbound traffic.

Inbound Firewall Rules

+ Add - Delete

<input type="checkbox"/>	ID	Service Type	Port	Internal IP	Protocol	Status	Modify
--	--	--	--	--	--	--	--

Interface Name:

Internal IP:

Service Type:

Port:  (XX or XX-XX, XX=1-65535)

Protocol:

Enable This Entry

4. Select an interface name from the drop-down list. Interface names are names of the internet connections you have set up.
5. Click [Scan](#) to select a service from the list to automatically populate the [Port](#) field with an appropriate port number. It is recommended to keep the default Port if you are unsure about which one to use. If the service is not listed, manually enter the [Service Type](#) and the [Port](#) number (e.g., 21 or 21-25).
6. Click [Scan](#) to select the local host device running the service. If the device is not listed, enter its global IPv6 address in the Global IPv6 Address field
7. Select a protocol for the service from the drop-down list.
8. Select [Enable This Entry](#) and click [Save](#).

Note: If you want to disable this entry, click the icon.

## Chapter 7

---

# Parental Controls

---

This function allows you to block inappropriate, explicit and malicious websites, and control access to specified websites at specified time.

## I want to:

Control the time of day my children or other home network users are allowed to access the internet and even types of websites they can visit.

For example, I want to allow my children's devices (e.g. a computer or a tablet) to access only [www.tp-link.com](http://www.tp-link.com) and [wikipedia.org](http://wikipedia.org), from 18:00 (6PM) to 22:00 (10PM) on weekdays only.

## How can I do that?

1. Visit <http://tplinkmodem.net>, and log in with the password or your TP-Link ID.
2. Go to **Basic** or **Advanced** > **Parental Controls** and enable **Parental Controls**.

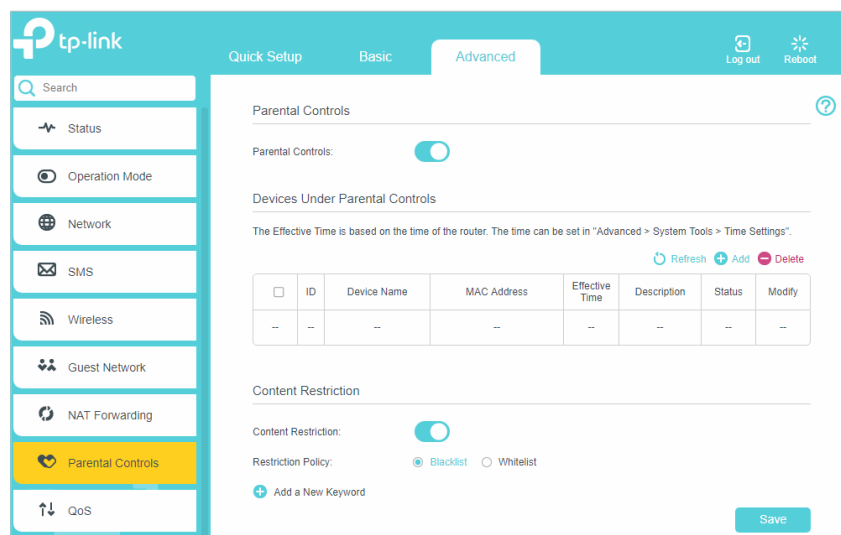

3. Click **Add**.

The screenshot shows the 'Add New Device' form in the TP-Link web interface. The form includes the following fields and buttons:

- Device Name:** A text input field with a 'Scan' button to its right.
- MAC Address:** A text input field with a hyphenated pattern (e.g., -- -- -- -- --).
- Effective Time:** A time selection field with a clock icon.
- Description:** A text input field.
- Enable This Entry:** A checked checkbox.
- Buttons:** 'Cancel' and 'Save' buttons at the bottom right.

4. Click [Scan](#) and select the device to be controlled. Or enter the [Device Name](#) and [MAC Address](#) manually.
5. Click the  icon to set the Effective Time. Drag the cursor over the appropriate cell(s) and click [OK](#).

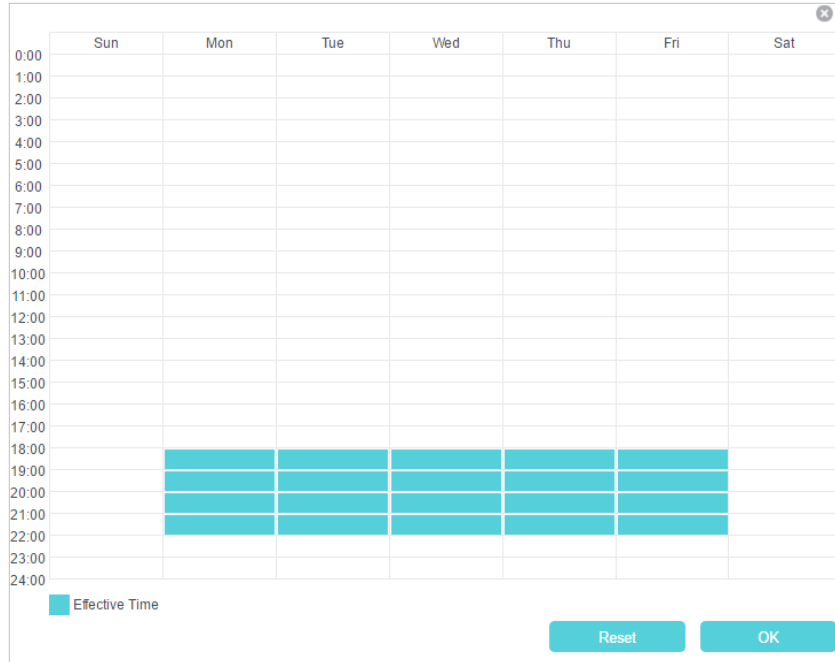

The image shows a grid for selecting an effective time. The vertical axis represents time from 0:00 to 24:00 in one-hour increments. The horizontal axis represents the days of the week: Sun, Mon, Tue, Wed, Thu, Fri, and Sat. A legend at the bottom left indicates that a teal square represents 'Effective Time'. In the grid, teal bars are present from 18:00 to 22:00 on Monday, Tuesday, Wednesday, Thursday, and Friday. At the bottom right, there are two buttons: 'Reset' and 'OK'.

6. Enter a [Description](#) for the entry.
7. Select the checkbox to enable this entry and click [Save](#).
8. Select the restriction type.
  - 1) With [Blacklist](#) selected, the controlled devices cannot access any websites containing the specified keywords during the Effective Time period.
  - 2) With [Whitelist](#) selected, the controlled devices can only access websites containing the specified keywords during the Effective Time period.

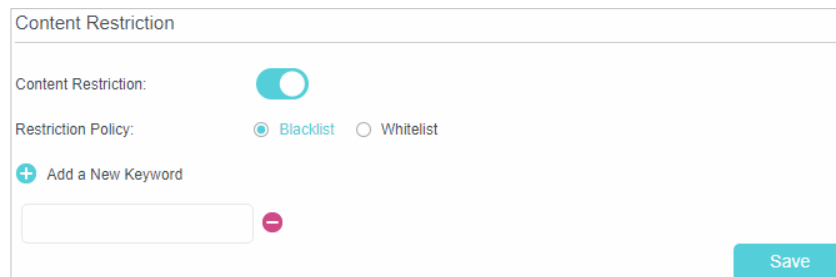

The image shows the 'Content Restriction' settings interface. At the top, it says 'Content Restriction'. Below that, there is a toggle switch for 'Content Restriction' which is turned on. Underneath, there are two radio buttons for 'Restriction Policy': 'Blacklist' (which is selected) and 'Whitelist'. Below the radio buttons is a plus sign icon followed by the text 'Add a New Keyword'. There is an empty text input field with a minus sign icon to its right. At the bottom right, there is a 'Save' button.

9. Click [Add a New Keyword](#). You can add up to 200 keywords for both Blacklist and Whitelist. Below are some sample entries to allow access.
  - 1) Enter a web address (e.g. [www.tp-link.com](http://www.tp-link.com)) or a web address keyword (e.g. [wikipedia](http://wikipedia.com)) to only allow or block access to the websites containing that keyword.

2) If you wish to block all internet browsing access, do not add any keyword to the [Whitelist](#).

10. Click [Save](#).

**Done!**

Now you can control your children's internet access according to your needs.

## Chapter 8

---

# SMS

---

This chapter introduces how to use the SMS functions to view and write messages, keep drafts and specify the message center number. You can easily monitor your data usage by sending a message to your carrier.

This chapter includes the following sections:



- [View Messages](#)
- [Edit and Send a New Message](#)
- [View Sent Messages](#)
- [View Drafts](#)
- [SMS Settings](#)

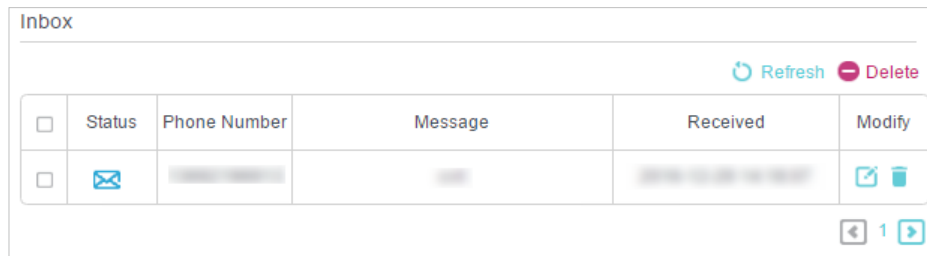

## 8.1. View Messages

1. Visit <http://tplinkmodem.net>, and log in with the password or your TP-Link ID.
2. Go to [Advanced](#) > [SMS](#) > [Inbox](#) page.



3. Click the  or  icon to unfold and read the content of the message.

 Tips:

 indicates the message is read, while  indicates the message is unread.

## 8.2. Edit and Send a New Message

1. Visit <http://tplinkmodem.net>, and log in with the password or your TP-Link ID.
2. Go to [Advanced](#) > [SMS](#) > [New Message](#) page.

3. Enter the receiver's phone number in the [Phone Number](#) field.
4. Enter your message in the [Content](#) field.







 Tips:



You can enter up to 160 letters or numbers, and any exceeding characters will be sent in the next message. You can send up to 5 messages each time.

5. Click [Send](#) to send the message or click [Save](#) to save the message to the Drafts.

## 8.3. View Sent Messages

1. Visit <http://tplinkmodem.net>, and log in with the password or your TP-Link ID.
2. Go to [Advanced](#) > [SMS](#) > [Outbox](#) page. All the messages you sent are listed in the [Outbox](#) table.

Outbox				
 Refresh  Delete				
<input type="checkbox"/>	Phone Number	Message	Sent	Modify
<input type="checkbox"/>	[REDACTED]	[REDACTED]	[REDACTED]	 
<input type="checkbox"/>	[REDACTED]	[REDACTED]	[REDACTED]	 





 1 



**Tips:**

You can click  to edit and forward the message.

## 8.4. View Drafts

1. Visit <http://tplinkmodem.net>, and log in with the password or your TP-Link ID.
2. Go to [Advanced](#) > [SMS](#) > [Drafts](#) page. All the unsent messages are listed in the [Drafts](#) table.

Drafts			
 Refresh  Delete			
<input type="checkbox"/>	Phone Number	Message	Modify
<input type="checkbox"/>	[REDACTED]	[REDACTED]	 

 1 

**Tips:**

You can click  to edit and forward the message.

## 8.5. SMS Settings

SMS Settings allows you to configure the Message Center. When the Message Center is enabled, you can change the Message Center Number via which messages will be sent. It is not recommended to change it for a wrong message center number will affect the SMS function of the router.

1. Visit <http://tplinkmodem.net>, and log in with the password or your TP-Link ID.
2. Go to [Advanced](#) > [SMS](#) > [SMS Settings](#) page and enable [Message Center](#).

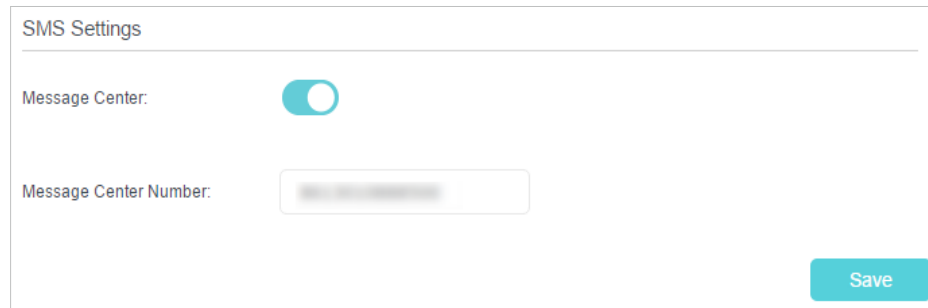

The image shows a screenshot of a web form titled "SMS Settings". The form contains two main sections: "Message Center" and "Message Center Number". The "Message Center" section has a toggle switch that is currently turned on. The "Message Center Number" section has a text input field that is auto-populated with a blurred number. A "Save" button is located at the bottom right of the form.

3. The **Message Center Number** is auto-populated. Change it according to your needs.
4. Click **Save** to apply your settings.

## Chapter 9

---

# Guest Network

---

This function allows you to provide Wi-Fi access for guests without disclosing your main network. When you have guests in your house, apartment, or workplace, you can create a guest network for them. In addition, you can customize guest network options to ensure network security, privacy, and fluency.

This chapter contains the following sections:

- [Create a Network for Guests](#)
- [Customize Guest Network Options](#)

## 9.1. Create a Network for Guests

1. Visit <http://tplinkmodem.net>, and log in with the password or your TP-Link ID.
2. Go to [Advanced](#) > [Guest Network](#). Locate the [Wireless](#) section.
3. Create a 2.4GHz or 5GHz guest network according to your needs.
  - 1) Enable [2.4GHz](#), [5GHz](#) or both wireless networks.
  - 2) Customize the SSID. Don't select [Hide SSID](#) unless you want your guests to manually input the SSID for guest network access.
  - 3) Set [Security](#) to [WPA/WPA2 Personal](#), keep the default [Version](#) and [Encryption](#) values, and customize your own password.

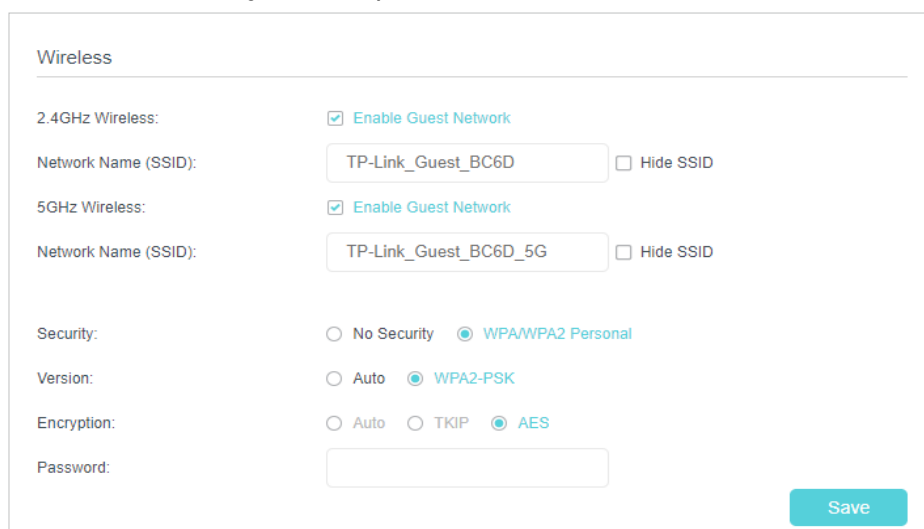

The screenshot shows the 'Wireless' configuration page for a TP-Link modem. It is divided into two sections: '2.4GHz Wireless' and '5GHz Wireless'. Each section has a checkbox for 'Enable Guest Network' which is checked. Below each checkbox is a text input field for the 'Network Name (SSID)'. The 2.4GHz SSID is 'TP-Link\_Guest\_BC6D' and the 5GHz SSID is 'TP-Link\_Guest\_BC6D\_5G'. To the right of each SSID field is a checkbox for 'Hide SSID', which is unchecked. Below these sections are radio button options for 'Security' (No Security, WPA/WPA2 Personal), 'Version' (Auto, WPA2-PSK), and 'Encryption' (Auto, TKIP, AES). The 'WPA/WPA2 Personal', 'WPA2-PSK', and 'AES' options are selected. At the bottom, there is a 'Password' text input field and a 'Save' button.

4. Click [Save](#). Now your guests can access your guest network using the SSID and password you set!

### Tips:

To view guest network information, go to [Advanced](#) > [Status](#) and locate the [Guest Network](#) section.

## 9.2. Customize Guest Network Options

1. Visit <http://tplinkmodem.net>, and log in with the password or your TP-Link ID.
2. Go to [Advanced](#) > [Guest Network](#). Locate the [Settings](#) section.
3. Customize guest network options according to your needs.

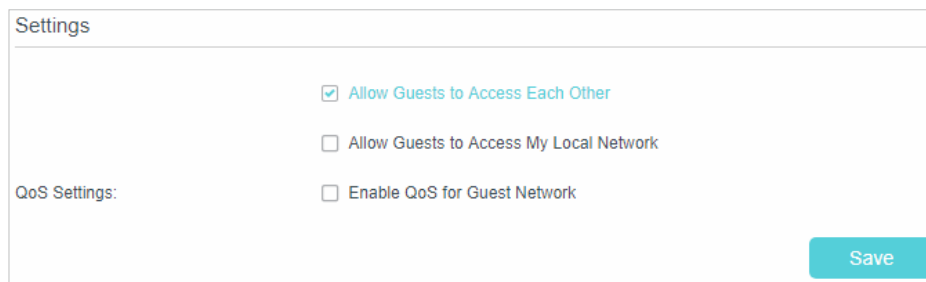

Settings

Allow Guests to Access Each Other

Allow Guests to Access My Local Network

QoS Settings:

Enable QoS for Guest Network

Save

- **Allow Guests to See Each Other**

Select this checkbox if you want to allow the wireless clients on your guest network to communicate with each other via methods such as network neighbors, Samba, Ping, and FTP.

- **Allow Guests to Access My Local Network**

Select this checkbox if you want to allow the wireless clients on your guest network to communicate with the devices connected to your router's LAN ports or main network via methods such as network neighbors, Samba, Ping, and FTP.

- **Enable QoS for Guest Network**

Select this checkbox if you want to assign the upstream and downstream bandwidths for the guest network. This option is available only when [QoS](#) is enabled on the [Advanced > QoS > Settings](#).

4. Click [Save](#). Now you can ensure network security, privacy, and fluency!

 **Tips:**

To view guest network information, go to [Advanced > Status](#) and find the [Guest Network](#) section.

## Chapter 10

---

# NAT Forwarding

---

Router's NAT (Network Address Translation) feature makes the devices in the LAN use the same public IP address to communicate in the internet, which protects the local network by hiding IP addresses of the devices. However, it also brings about the problem that external host cannot initiatively communicate with the specified device in the local network.

With forwarding feature the router can penetrate the isolation of NAT and allows the external hosts on the internet to initiatively communicate with the devices in the local network, thus to realize some special functions.

TP-Link router includes four forwarding rules. If two or more rules are set, the priority of implementation from high to low is Virtual Servers, Port Triggering, UPnP and DMZ.

This chapter contains the following sections:

- [Translate Address and Port by ALG](#)
- [Share Local Resources in the Internet by Virtual Server](#)
- [Open Ports Dynamically by Port Triggering](#)
- [Make Applications Free from Port Restriction by DMZ](#)
- [Make Xbox Online Games Run Smoothly by UPnP](#)

## 10. 1. Translate Address and Port by ALG

ALG (Application Layer Gateway) allows customized NAT (Network Address Translation) traversal filters to be plugged into the gateway to support address and port translation for certain application layer "control/data" protocols: FTP, TFTP, H323 etc. Enabling ALG is recommended.

1. Visit <http://tplinkmodem.net>, and log in with the password or your TP-Link ID.
2. Go to **Advanced > NAT Forwarding > ALG**.

### ■ Note:

It is recommended to keep the default settings.

- **PPTP Pass-through:** If enabled, it allows Point-to-Point sessions to be tunneled through an IP network and passed through the router.
- **L2TP Pass-through:** If enabled, it allows Layer 2 Point-to-Point sessions to be tunneled through an IP network and passed through the router.
- **IPSec Pass-through:** If enabled, it allows IPSec (Internet Protocol Security) to be tunneled through an IP network and passed through the router. IPSec uses cryptographic security services to ensure private and secure communications over IP networks.
- **FTP ALG:** If enabled, it allows FTP (File Transfer Protocol) clients and servers to transfer data via NAT.
- **TFTP ALG:** If enabled, it allows TFTP (Trivial File Transfer Protocol) clients and servers to transfer data via NAT.
- **H323 ALG:** If enabled, it allows Microsoft NetMeeting clients to communicate via NAT.
- **SIP ALG:** If enabled, it allows clients communicate with SIP (Session Initiation Protocol) servers via NAT.

## 10. 2. Share Local Resources in the Internet by Virtual Server

When you build up a server in the local network and want to share it on the internet, Virtual Server can realize the service and provide it to the internet users. At the same time virtual server can keep the local network safe as other services are still invisible from the internet.

Virtual server can be used for setting up public services in your local network, such as HTTP, FTP, DNS, POP3/SMTP and Telnet. Different service uses different service port. Port 80 is used in HTTP service, port 21 in FTP service, port 25 in SMTP service and port 110 in POP3 service. Please verify the service port number before the configuration.

### I want to:



Share my personal website I've built in local network with my friends through the internet. For example, the personal website has been built in my home PC (192.168.1.100). I hope that my friends in the internet can visit my website in some way. The PC is connected to the router with the WAN IP address 218.18.232.154.

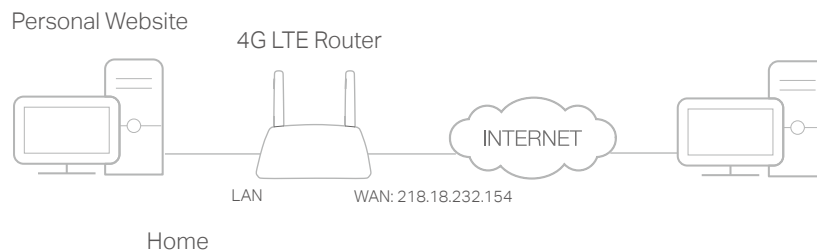

## How can I do that?

1. Assign a static IP address to your PC, for example 192.168.1.100.
2. Visit <http://tplinkmodem.net>, and log in with the password or your TP-Link ID.
3. Go to **Advanced > NAT Forwarding > Virtual Servers**, click **Add**.

Virtual Servers

+ Add - Delete

☐	ID	Service Type	External Port	Internal IP	Internal Port	Protocol	Status	Modify
-	-	-	-	-	-	-	-	-

Note: Virtual Server can be configured only when there is an available interface. If the external port is already used for Remote Management or CWMP, Virtual Server will not take effect.

Interface Name:

Service Type:  View Existing Applications

External Port:  (XX-XX or XX)

Internal IP:

Internal Port:  (XX or Blank, 1-65535)

Protocol:

Enable This Entry

Cancel
Save

4. Click **View Existing Services**, and choose **HTTP**. The external port, internal port and protocol will be auto-populated. Enter the PC's IP address 192.168.1.100 in the **Internal IP** field.
5. Click **Save** to save the settings.

### Note:

1. It is recommended to keep the default settings of **Internal Port** and **Protocol** if you are not clear about which port and protocol to use.
2. If the service you want to use is not in the **Service Type**, you can enter the corresponding parameters manually. You should verify the port number that the service needs.

- You can add multiple virtual server rules if you want to provide several services in a router. Please note that the **External Port** cannot be overlapped.

## Done!

Users in the internet can enter [http:// WAN IP](http://WAN IP) (in this example, enter [http:// 218.18.232.154](http://218.18.232.154)) to visit your personal website.

### Note:

- WAN IP should be a public IP address. For the WAN IP is assigned dynamically by ISP, it is recommended to apply and register a domain name for the WAN by DDNS, go to [Set Up a Dynamic DNS Service Account](#) for more information. Then you can use <http://domain name> to visit the website.
- If you have changed the default **External Port**, you should use <http://WAN IP: External Port> or <http://domain name: External Port> to visit the website.

## 10.3. Open Ports Dynamically by Port Triggering

Port triggering can specify a triggering port and its corresponding external ports. When a host in the local network initiates a connection to the triggering port, all the external ports will be opened for subsequent connections. The router can record the IP address of the host. When the data from the internet return to the external ports, the router can forward them to the corresponding host. Port triggering is mainly applied to online games, VoIPs and video players. Common applications include MSN Gaming Zone, Dialpad and Quick Time 4 players, etc.

Follow the steps below to configure the port triggering rules:

- Visit <http://tplinkmodem.net>, and log in with the password or your TP-Link ID.
- Go to **Advanced > NAT Forwarding > Port Triggering** and click **Add**.

Port Triggering

+ Add - Delete

☐	ID	Application	Triggering Port	Triggering Protocol	External Port	External Protocol	Status	Modify
--	--	--	--	--	--	--	--	--

Interface Name:

Application:  View Existing Applications

Triggering Port:  (XX, 1-65535)

Triggering Protocol:

External Port:  (XX or XX-XX, 1-65535, at most 5 pairs)

External Protocol:

Enable This Entry

Cancel
Save

3. Click [View Existing Applications](#), and select the desired application. The triggering port and protocol, the external port and protocol will be auto-populated. Here we take application [MSN Gaming Zone](#) as an example.
4. Click [Save](#) to apply the settings.

📌 **Tips:**

1. You can add multiple port triggering rules according to your network need.
2. If the application you need is not listed in the [Existing Applications](#) list, please enter the parameters manually. You should verify the external ports the application uses first and enter them into [External Port](#) field according to the format the page displays.

## 10.4. Make Applications Free from Port Restriction by DMZ

When a PC is set to be a DMZ (Demilitarized Zone) host in the local network, it is totally exposed to the internet, which can realize the unlimited bidirectional communication between internal hosts and external hosts. The DMZ host becomes a virtual server with all ports opened. When you are not clear about which ports to open in some special applications, like IP camera and database software, you can set the PC to be a DMZ host.

📌 **Note:**

DMZ is more applicable in the situation that users are not clear about which ports to open. When it is enabled, the DMZ host is totally exposed to the internet, which may bring some potential safety hazard. If DMZ is not in use, please disable it in time.

### I want to:

Make the home PC join the internet online game without port restriction.

[For example](#), due to some port restriction, when playing the online games, you can log in normally but cannot join a team with other players. To solve this problem, set your PC as a DMZ with all ports opened.

### How can I do that?

1. Assign a static IP address to your PC, for example 192.168.1.100.
2. Visit <http://tplinkmodem.net>, and log in with the password or your TP-Link ID.
3. Go to [Advanced](#) > [NAT Forwarding](#) > [DMZ](#) and select the checkbox to enable DMZ.



DMZ

DMZ:  Enable

DMZ Host IP Address:

Save

4. Enter the IP address 192.168.1.100 in the [DMZ Host IP Address](#) field.

5. Click [Save](#) to save the settings.

## Done!

The configuration is completed. You've set your PC to a DMZ host and now you can make a team to game with other players.

## 10.5. Make Xbox Online Games Run Smoothly by UPnP

UPnP (Universal Plug and Play) protocol allows the applications or host devices to automatically find the front-end NAT device and send request to it to open the corresponding ports. With UPnP enabled, the applications or host devices in the both sides of NAT device can freely communicate with each other, realizing the seamless connection of the network. You may need to enable the UPnP if you want to use applications for multiplayer gaming, peer-to-peer connections, real-time communication (such as VoIP or telephone conference) or remote assistance, etc.

### Tips:

1. UPnP is enabled by default in this router.
2. Only the application supporting UPnP protocol can use this feature.
3. UPnP feature needs the support of operating system (e.g. Windows Vista/ Windows 7/ Windows 8, etc. Some of operating system need to install the UPnP components).

For example, when you connect your Xbox to the router which has connected to the internet to play online games, UPnP will send requests to the router to open the corresponding ports, allowing the following data penetrating the NAT to transmit. Therefore, you can play Xbox online games without a hitch.

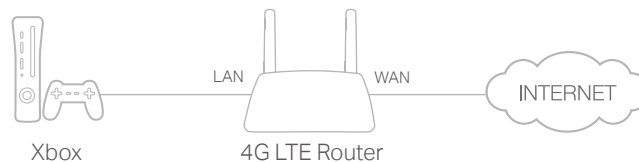

If necessary, you can follow the steps to change the status of UPnP.

1. Visit <http://tplinkmodem.net>, and log in with the password or your TP-Link ID;
2. Go to **Advanced > NAT Forwarding > UPnP** and toggle on or off according to your needs.

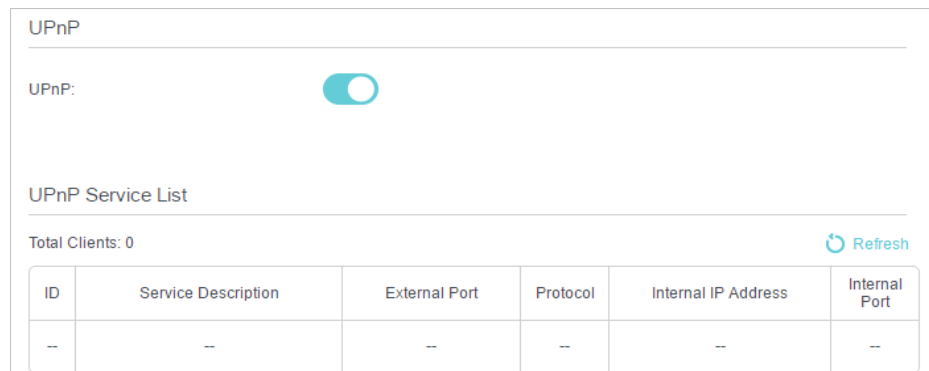

## Chapter 11

---

# Specify Your Network Settings

---

This chapter introduces how to change the default settings or adjust the basic configuration of the router using the web-based management page.

This chapter contains the following sections:

- [Upgrade Your ISP Information](#)
- [PIN Management](#)
- [Data Settings](#)
- [LAN Settings](#)
- [Wireless Settings](#)
- [Set Up a Dynamic DNS Service Account](#)
- [Create Static Routes](#)
- [Set up a VPN Connection](#)
- [USSD](#)

## 11.1. Upgrade Your ISP Information

If your ISP information is not detected by the router, you can upgrade ISP information by following the steps below:

1. Download the latest ISP upgrade file from the [Support](#) page at <https://www.tp-link.com> to your computer.
2. Visit <http://tplinkmodem.net>, and log in with your TP-Link ID or the password you set for the router.
3. Go to [Advanced](#) > [Network](#) > [ISP Upgrade](#).

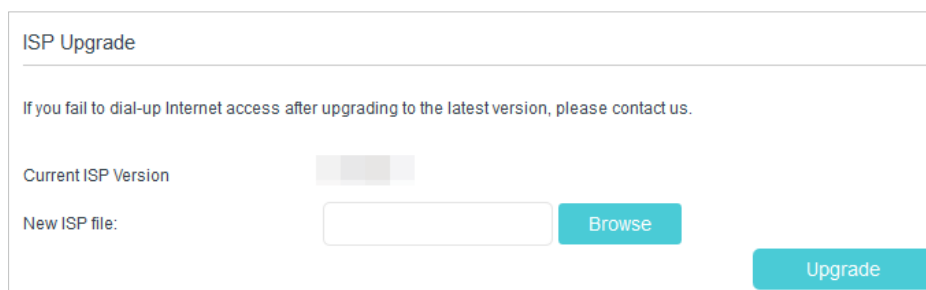

The screenshot shows the 'ISP Upgrade' page. At the top, it says 'ISP Upgrade'. Below that is a warning: 'If you fail to dial-up Internet access after upgrading to the latest version, please contact us.' There are two sections: 'Current ISP Version' with a greyed-out input field, and 'New ISP file:' with a text input field and a 'Browse' button. At the bottom right is a large 'Upgrade' button.

4. Click [Browse](#) to locate and select the latest file.
5. Click [Upgrade](#).

**Note:**

1. If you fail to dial-up Internet access after upgrading to the latest version, please contact the technical support.
2. If your ISP settings are still not detected after upgrading, refer to [Create a Connection Profile](#) to add a new internet connection profile.

## 11.2. PIN Management

PIN (Personal Identification Number) is used to protect the SIM card from embezzlement. PIN Management allows you to easily change the PIN settings of your SIM card as needed.

Follow the steps below to change your PIN settings.

1. Visit <http://tplinkmodem.net>, and log in with the password or your TP-Link ID.
2. Go to [Advanced](#) > [Network](#) > [PIN Management](#) page.

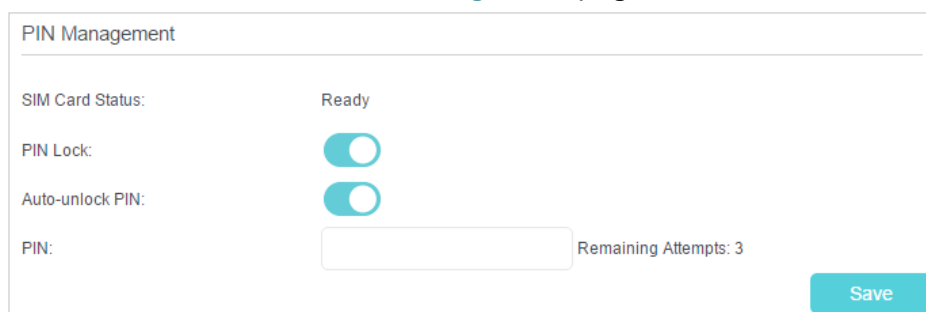

The screenshot shows the 'PIN Management' page. It displays 'SIM Card Status: Ready'. There are two toggle switches: 'PIN Lock' (which is turned on) and 'Auto-unlock PIN' (which is turned off). Below these is a 'PIN:' input field and a 'Remaining Attempts: 3' indicator. A 'Save' button is located at the bottom right.

- **SIM Card Status** - Displays the status of your SIM card.
  - **PIN Lock** - Toggle on to enable PIN Lock. Once it is enabled, every time you start the router with this SIM card inserted, you need to enter the PIN.
  - **Auto-unlock PIN** - When the PIN is required upon router restarting or inserting a SIM card, it will be validated automatically, saving you the trouble to enter the PIN each time you start the router or insert a SIM card. If validation failed, you need to enter the PIN on this page.
  - **PIN** - Enter the PIN to unlock the SIM card. It consists of 4-8 digits.
  - **PUK** - PIN Unlocked Key, also known as Personal Unlock Code (PUC), is used to reset a PIN that has been lost or forgotten. The PUK is a SIM-specific code assigned by the service provider. You need to enter the PUK after 3 incorrect login attempts of PIN. Contact your service provider if you do not know the PUK. It consists of 8 digits.
  - **New PIN** - Enter 4-8 digits to reset the PIN of your SIM card.
  - **Remaining Attempts** - Shows how many attempts are left for you to try entering the PIN or PUK. You have only 3 attempts for entering the PIN and 10 attempts for entering the PUK. If you accidentally fail in 3 attempts, the SIM card will be locked and you will be required to enter the PUK that is written on your SIM card.
3. Click **Save** to save the settings.

### 11.3. Data Settings

Data Settings is used to monitor the data usage of your router in real-time. You can limit your data usage according to your monthly allowance or total allowance and you will receive a warning if your data usage reaches the specified level.

Follow the steps below to monitor your data usage.

1. Visit <http://tplinkmodem.net>, and log in with the password or your TP-Link ID.
2. Go to **Advanced > Network > Data Settings** page.

The screenshot shows the 'Data Settings' page. At the top, it displays 'Monthly Used: 0.000 MB' with a 'Correct' button. Below this, there is a note: 'You can send messages to your carrier for accurate data usage.' The 'Data Limit' section has a toggle switch that is turned on. A sub-note states: 'The router will automatically disconnect from the network when the data usage limit is reached.' The 'Monthly Allowance' field is empty, with a unit dropdown set to 'MB'. The 'Usage Alert' field is set to '90%'. The 'SMS Alert for Usage' field contains 'Please enter phone number' and a 'Send Test Message' button. A red note below reads: 'Note: This function may cause SMS charges.' The 'Monthly Data Statistics' section has a toggle switch that is turned on. The 'Start Date' field is set to '1'. A 'Save' button is located at the bottom right of the form.



3. Enable [Data Limit](#) to set total/monthly data allowance and usage alert to prevent data overuse.
4. Enter the allowed amount of total/monthly data in the [Total/Monthly Allowance](#) field. When data usage exceeds the allowed level, the router will disconnect from the internet and notify you on the [Basic > Network Map](#) Page.
5. Enter a percentage in the [Usage Alert](#) field to prevent data overuse. When data usage reaches the alert level, a warning will be shown on the [Basic > Network Map](#) Page. If you want to want receive the alert on your phone, enter your mobile phone number in the [SMS Alert for Usage](#) field.
6. Enable [Monthly Data Statistics](#) to reset data statistics when the next billing cycle starts.
7. Enter the start date of the billing cycle in the [Start Date](#) field.
8. Click [Save](#) to save the settings.

## 11.4. LAN Settings

### 11.4.1. Change the LAN IP Address

The router is preset with a default LAN IP 192.168.1.1, which you can use to log in to its web management page. The LAN IP address together with the Subnet Mask also defines the subnet that the connected devices are on. If the IP address conflicts with another device on your local network or your network requires a specific IP subnet, you can change it.

Follow the steps below to change your IP address.

1. Visit <http://tplinkmodem.net>, and log in with the password or your TP-Link ID.
2. Go to [Advanced > Network > LAN Settings](#) page.

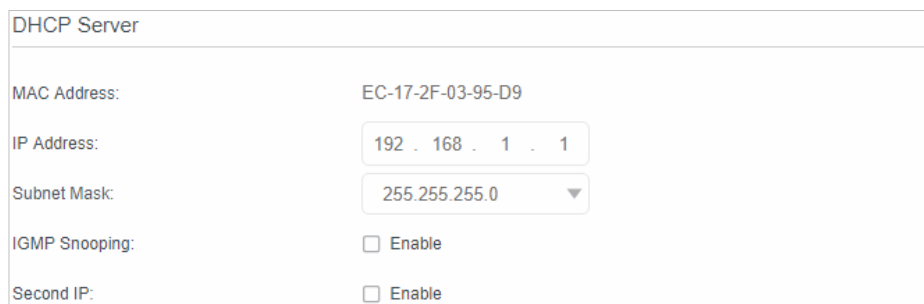

DHCP Server	
MAC Address:	EC-17-2F-03-95-D9
IP Address:	192 . 168 . 1 . 1
Subnet Mask:	255.255.255.0 ▼
IGMP Snooping:	<input type="checkbox"/> Enable
Second IP:	<input type="checkbox"/> Enable

3. Type in a new [IP Address](#) as needed.
4. Select the [Subnet Mask](#) from the drop-down list. The subnet mask together with the IP address identifies the local IP subnet.

5. You can configure the router's **Second IP** and **Subnet Mask** for LAN interface through which you can also access the web management page.
6. You can enable **IGMP (Internet Group Management Protocol) Snooping** feature to optimize overall network performance when your network has plenty of multicast traffic.
7. Click **Save** to make the settings effective.

### 11.4.2. Use the 4G LTE Router as a DHCP Server

You can configure the router to act as a DHCP server to assign IP addresses to its clients. To use the DHCP server function of the router, you must configure all computers on the LAN to obtain an IP Address automatically.

Follow the steps below to configure DHCP server.

1. Visit <http://tplinkmodem.net>, and log in with the password or your TP-Link ID.
2. Go to **Advanced > Network > LAN Settings** page.

DHCP:	<input checked="" type="checkbox"/> Enable
IP Address Pool:	192 . 168 . 1 . 100 - 192 . 168 . 1 . 199
Address Lease Time:	1440 minutes. (1-2880. The default value is 1440.)
Default Gateway:	192 . 168 . 1 . 1 (Optional)
Default Domain:	(Optional)
Primary DNS:	0 . 0 . 0 . 0 (Optional)
Secondary DNS:	0 . 0 . 0 . 0 (Optional)

**Save**

3. Select **DHCP** to enable the DHCP function and select **DHCP Server**.
4. Specify the **IP Address Pool**, the start address and end address must be on the same subnet with LAN IP. The router will assign addresses within this specified range to its clients. It is from 192.168.1.100 to 192.168.1.199 by default.
5. Enter a value for the **Address Lease Time**. The **Address Lease Time** is the amount of time in which a DHCP client can lease its current dynamic IP address assigned by the router. After the dynamic IP address expires, the user will be automatically assigned a new dynamic IP address. The default is 1440 minutes.
6. Keep the rest of the settings as default and click **Save** to make the settings effective.

**Note:**

1. The router can be configured to work as a **DHCP Relay**. A DHCP relay is a computer that forwards DHCP data between computers that request IP addresses and the DHCP server that assigns the addresses. Each of the device's interfaces can be configured as a DHCP relay. If it is enabled, the DHCP requests from local PCs will be forwarded to the DHCP server that runs on WAN side.

- You can also appoint IP addresses within a specified range to devices of the same type by using [Condition Pool](#) feature. For example, you can assign IP addresses within the range (192.168.1.50 to 192.168.1.80) to Camera devices, thus facilitating the network management. Enable DHCP feature and configure the parameters according to your actual situation on [Advanced > Network > LAN Settings](#) page.

### 11.4.3. Reserve LAN IP Addresses

You can view and add a reserved address for a client. When you specify an IP address for a device on the LAN, that device will always receive the same IP address each time when it accesses the DHCP server. If there are some devices in the LAN that require permanent IP addresses, please configure Address Reservation on the router for the purpose.

Follow the steps below to reserve an IP address for your device.

- Visit <http://tplinkmodem.net>, and log in with the password or your TP-Link ID.
- Go to [Advanced > Network > LAN Settings](#) page.
- Scroll down to locate the [Address Reservation](#) table and click [Add](#) to add an address reservation entry for your device.

The screenshot shows the 'Address Reservation' configuration interface. At the top, there are '+ Add' and '- Delete' buttons. Below is a table with the following structure:

<input type="checkbox"/>	MAC Address	Reserved IP Address	Group	Status	Modify
--	--	--	--	--	--

Below the table, the configuration form includes:

- MAC Address: [Input field with dashes] [Scan button]
- IP Address: [Input field with dots]
- Group: [Dropdown menu with 'Default' selected]
- Enable This Entry
- [Cancel button] [Save button]

- Enter the [MAC address](#) of the device for which you want to reserve IP address.
- Specify the IP address which will be reserved by the router.
- Check [Enable this entry](#) and click [Save](#) to make the settings effective.

## 11.5. Wireless Settings

### 11.5.1. Specify Basic Wireless Settings

The router's wireless network name (SSID), password, and security option are preset in the factory. The preset SSID and password can be found on the product label. You can customize the wireless settings according to your needs.

1. Visit <http://tplinkmodem.net>, and log in with the password or your TP-Link ID.
2. Go to **Basic > Wireless** page.

Smart Connect

Smart Connect

Smart Connect allows your mobile device to automatically switch to the Wi-Fi band that provides the fastest speed.

Wireless Settings

2.4GHz Wireless Network:  Enable

Network Name (SSID):   Hide SSID

Password:

5GHz Wireless Network:  Enable

Network Name (SSID):   Hide SSID

Password:

Save

- **To enable or disable the wireless function:**

Enable the **2.4GHz** or **5GHz Wireless Network**. If you don't want to use the wireless function, just uncheck the box. If you disable the wireless function, all the wireless settings won't be effective.

- **To enable Smart Connect function:**

Smart Connect allows your mobile device to automatically switch to the Wi-Fi band that provides the fastest speed. Toggle on to enable this feature.

- **To change the wireless network name (SSID) and wireless password:**

Enter a new SSID. The default SSID is TP-Link\_XXXX and the value is case-sensitive.

**Note:**

If you use a wireless device to change the wireless settings, you will be disconnected when the settings are effective. Please write down the new SSID and password for future use.

- **To hide SSID:**

Select **Hide SSID**, and your SSID will not broadcast. Your SSID won't display when you scan for local wireless network list on your wireless device and you need to manually join the network.

- **To change the mode or channel:**

Go to **Advanced > Wireless > Wireless Settings** page and select the wireless network 2.4GHz or 5GHz.

- **Mode** - Select the desired mode.
  - **802.11n only** - Select only if all of your wireless clients are 802.11n devices.
  - **802.11gn mixed** - Select if you are using both 802.11g and 802.11n wireless clients.
  - **802.11bgn mixed** - Select if you are using a mix of 802.11b, 11g, and 11n wireless clients.

**Note:**

When 802.11n only mode is selected, only 802.11n wireless stations can connect to the router. It is strongly recommended that you select 802.11bgn mixed, and all of 802.11b, 802.11g, and 802.11n wireless clients can connect to the router.

- **802.11ac/n mixed (5GHz)** - Select if you are using both 802.11ac and 802.11n wireless clients.
- **802.11a/n/ac mixed (5GHz)** - Select if you are using a mix of 802.11a, 802.11n and 802.11ac wireless clients. It is strongly recommended that you select 11a/n/ac mixed.
- **Channel** - Select the channel you want to use from the drop-down list. This field determines which operating frequency will be used. It is not necessary to change the wireless channel unless you notice interference problems with another nearby access point.
- **Channel Width** - Select the channel width from the drop-down list. The default setting is **Automatic**, which can adjust the channel width for your clients automatically.
- **Transmit Power** - Select either High, Middle, or Low to specify the data transmit power. The default and recommended setting is **High**.

- **To change the security option:**

1. Go to **Advanced > Wireless > Wireless Settings** page.
2. Select the wireless network **2.4GHz** or **5GHz**.
3. Select an option from the **Security** drop-down list. The router provides four options, None, WPA/WPA2 Personal (Recommended), WPA/WPA2 Enterprise, WEP. WPA2 uses the newest standard and the security level is the highest. We recommend you don't change the default settings unless necessary.

## 11.5.2. Use WPS for Wireless Connection

You can use WPS feature to add a new wireless device to your existing network quickly.

### Method 1 Use the Wi-Fi Protected Setup Button

Use this method if your client device has a Wi-Fi Protected Setup button.

1. Press the WPS/RESET button on the back panel of the router for 1 second.

**Note:**

You can also use the Push button on the web management page. Go to [Advanced > Wireless > WPS](#) page and click the Start WPS button on the screen.



2. Press the WPS button of the client device within two minutes.
3. The Wi-Fi LED flashes for about two minutes during the WPS process.
4. When the Wi-Fi LED is on, the client device has successfully connected to the router.

### Method 2 Enter the client device's PIN on the router

1. Visit <http://tplinkmodem.net>, and log in with the password or your TP-Link ID.
2. Go to [Advanced > Wireless > WPS](#) page.

WPS Method

Method One--Push Button(recommended)



Method Two--PIN

Router's PIN  Client's PIN

Enter the client's PIN:

3. Select [Method Two--PIN](#) and select [Client's PIN](#) radio button.

4. Enter the client device's PIN in the field, then click **Connect**.
5. **Connect successfully** will appear on the above screen, which means the client device has successfully connected to the router.

### Method 3 Enter the router's PIN on your client device

Use this method if your client device asks for the router's PIN.

1. Visit <http://tplinkmodem.net>, and log in with the password or your TP-Link ID.
2. Go to **Advanced > Wireless > WPS** page.

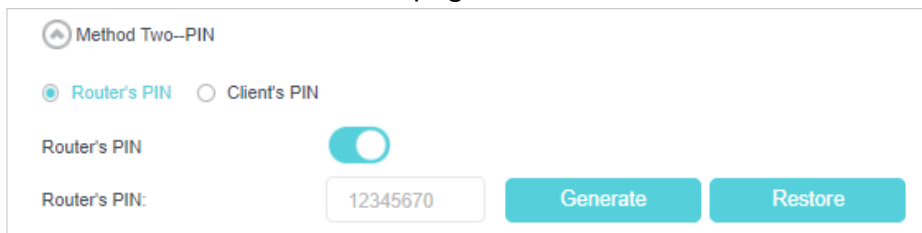

The screenshot shows the 'Method Two--PIN' configuration page. It has two radio buttons: 'Router's PIN' (selected) and 'Client's PIN'. Below the radio buttons is a toggle switch for 'Router's PIN' which is turned on. Underneath, there is a text input field labeled 'Router's PIN:' containing the value '12345670'. To the right of the input field are two buttons: 'Generate' and 'Restore'.

3. Take a note of the Current PIN of the router. You can also click the **Generate** button to get a new PIN.
4. On the client device, enter the router's PIN. (The default PIN is also labeled on the bottom of the router.)
5. The Wi-Fi LED flashes for about two minutes during the WPS process.
6. When the Wi-Fi LED is on, the client device has successfully connected to the router.

#### Note:

1. The Wi-Fi LED on the router will light on for no more than five minutes if the device has been successfully added to the network.
2. The WPS function cannot be configured if the wireless function of the router is disabled. Please make sure the wireless function is enabled before configuring the WPS.

### 11.5.3. Schedule Your Wireless Function

You can automatically turn off your wireless network at time when you do not need the wireless connection.

1. Visit <http://tplinkmodem.net>, and log in with the password or your TP-Link ID.
2. Go to **Advanced > Wireless > Wireless Schedule** page.
3. Toggle on the button to enable the Wireless Schedule feature.

Wireless Schedule

Wireless Schedule:

Wireless Off Time

+ Add - Delete

<input type="checkbox"/>	ID	Wireless Off Time	Repeat	Modify
--	--	--	--	--

From:

To:

Repeat:  Every Day  Selected Day

Cancel Save

4. Set the wireless off time. Select **From** and **To** time and click **Save** to make the settings effective. You can repeat the schedule every day or just certain days in a week.

**Note:**

1. Please make sure that the time of the router is correct before using this function. For more details, refer to [Set System Time](#).
2. The wireless LED will turn off if both wireless networks are disabled.
3. The wireless network will be automatically turned on after the time period you set.

### 11.5.4. View Wireless Information

- **To view the detailed wireless network settings:**

1. Visit <http://tplinkmodem.net>, and log in with the password or your TP-Link ID.
2. Go to **Advanced > Status** page. You can see the **Wireless** box.
3. Select 2.4GHz or 5GHz to view the wireless details.

Wireless 2.4GHz | 5GHz

Network Name (SSID): TP-Link\_8258

Wireless Radio: On

Mode: 802.11bgn mixed

Channel Width: Auto

Channel: Auto(2)

MAC Address: EC:17:2F:A5:82:58

**Tips:**

You can also see the wireless details by clicking the router icon on **Basic > Network Map**.



- **To view the detailed information of the connected wireless clients:**
  1. Visit <http://tplinkmodem.net>, and log in with the password or your TP-Link ID.
  2. Go to [Advanced](#) > [Wireless](#) > [Statistics](#) page.
  3. You can view the detailed information of the wireless clients, including its connected wireless band and security option as well as the packets transmitted.

📌 **Tips:**

You can also see the wireless details by clicking the wireless clients icon on [Basic](#) > [Network Map](#).

### 11.5.5. Advanced Wireless Settings

Advanced wireless settings are for those who have a network concept. If you are not familiar with the settings on this page, it's strongly recommended that you keep the provided default values; otherwise it may result in lower wireless network performance.

1. Visit <http://tplinkmodem.net>, and log in with the password or your TP-Link ID.
2. Go to [Advanced](#) > [Wireless](#) > [Advanced Settings](#) page.

Advanced Settings		2.4GHz   5GHz
Beacon Interval:	<input type="text" value="100"/>	(25-1000)
RTS Threshold:	<input type="text" value="2346"/>	(1-2346)
DTIM Interval:	<input type="text" value="1"/>	(1-255)
Group Key Update Period:	<input type="text" value="0"/>	seconds
WMM:	<input checked="" type="checkbox"/> Enable	
Short GI:	<input checked="" type="checkbox"/> Enable	
AP Isolation:	<input type="checkbox"/> Enable	

[Save](#)

- **Beacon Interval** - Enter a value between 25 and 1000 in milliseconds to determine the duration between which beacon packets are broadcasted by the router to synchronize the wireless network. The default is 100 milliseconds.
- **RTS Threshold** - Enter a value between 1 and 2346 to determine the packet size of data transmission through the router. By default, the RTS (Request to Send) Threshold size is 2346. If the packet size is greater than the preset threshold, the router sends Request to Send frames to a particular receiving station and negotiates the sending of a data frame, or else the packet will be sent immediately.
- **DTIM Interval** - Enter a value between 1 and 255 to determine the interval of the Delivery Traffic Indication Message (DTIM). 1 indicates the DTIM Interval is the same as **Beacon Interval**.

- **Group Key Update Period** - Enter the number of seconds (minimum 30) to control the time interval for the encryption key automatic renewal. The default is 0, indicating no key renewal.
- **WMM** - This feature guarantees the packets with high-priority messages being transmitted preferentially. WMM is enabled compulsively under 802.11n or 802.11ac mode. It is strongly recommended to enable WMM.
- **Short GI** - This feature is enabled by default and recommended to increase the data capacity by reducing the Guard Interval (GI) time.
- **AP Isolation** - Select this checkbox to enable the AP Isolation feature that allows you to confine and restrict all wireless devices on your network from interacting with each other, but still able to access the internet. AP isolation is disabled by default.

## 11.6. Set Up a Dynamic DNS Service Account

Most ISPs (internet service providers) assign a dynamic IP address to the router and you can use this IP address to access your router remotely. However, the IP address can change any time and you don't know when it changes. In this case, you might need the DDNS (Dynamic Domain Name Server) feature on the router to allow you and your friends to access your router and local servers (FTP, HTTP, etc.) using domain name, in no need of checking and remembering the IP address.

**Note:**

DDNS does not work if the ISP assigns a private WAN IP address (such as 192.168.1.x) to the router.

To set up DDNS, please follow the instructions below:

1. Visit <http://tplinkmodem.net>, and log in with the password or your TP-Link ID.
2. Go to **Advanced > Network > Dynamic DNS**.
3. Select the DDNS **Service Provider**: TP-Link, NO-IP or DynDNS. It is recommended to select TP-Link so that you can enjoy TP-Link's superior DDNS service. Otherwise, please select NO-IP or DynDNS. If you don't have a DDNS account, you have to register first by clicking **Go to register**.

**Dynamic DNS**

---

Service Provider:  TP-Link  NO-IP  DynDNS

Current Domain Name: ---

Domain Name List

+ Register - Delete

	Domain Name	Registered Date	Status	Operation	Modify
<input type="checkbox"/>	--	--	--	--	--

**Note:**

To enjoy TP-Link's DDNS service, you have to log in with a TP-Link ID. If you have not logged in with one, click [Log in](#).

### Dynamic DNS

Service Provider:  TP-Link  NO-IP  DynDNS

DDNS Unavailable

To use our superior TP-LINK DDNS service, please [Log in](#) with your TP-LINK Cloud account, or choose another service provider.

- Click [Register](#) in the [Domain Name List](#) if you have selected TP-Link, and enter the [Domain Name](#) as needed.

### Dynamic DNS

Service Provider:  TP-Link  NO-IP  DynDNS

Current Domain Name: ---

#### Domain Name List

[+ Register](#) [- Delete](#)

	Domain Name	Registered Date	Status	Operation	Modify
<input type="checkbox"/>	--	--	--	--	--

If you have selected NO-IP or DynDNS, enter the username, password and domain name of your account.

### Dynamic DNS

Service Provider:  TP-Link  NO-IP  DynDNS [Go to register...](#)

Username:

Password:

Domain Name:

Update Interval:

WAN IP binding:  Disable  Enable

[Login and Save](#) [Logout](#) ✘ Not launching

- Click [Login and Save](#).

**Tips:**

If you want to use a new DDNS account, please click [logout](#) first, and then log in with a new account.

## 11.7. Create Static Routes

A static route is a pre-determined path that network information must travel to reach a specific host or network. Data from one point to another will always follow the same path regardless of other considerations. Normal internet usage does not require this setting to be configured.

### I want to:

Visit multiple networks and multiple servers at the same time.

**For example**, in a small office, my PC can surf the internet, but I also want to visit my company's server. Now I have a switch and another router. I connect the devices as shown in the following figure so that the physical connection between my PC and my company's server is achieved. To surf the internet and visit my company's network at the same time, I need to configure the static routing.

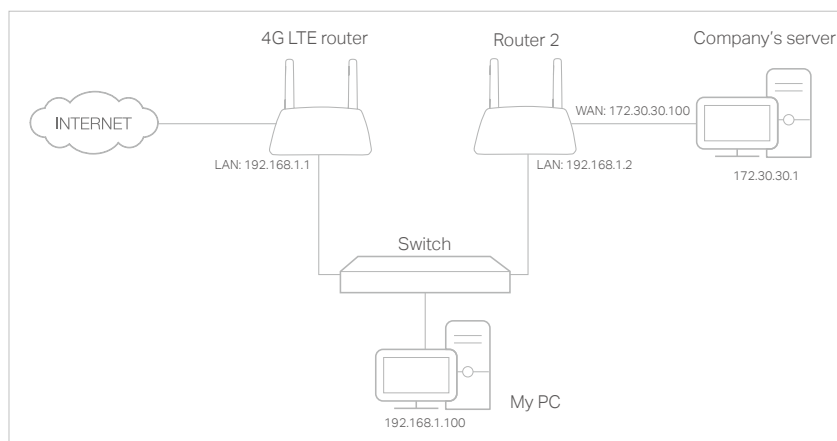

### How can I do that?

1. Make sure the routers use different LAN IP addresses on the same subnet. Disable DHCP function of Router 2.
2. Visit <http://tplinkmodem.net>, and log in with the password or your TP-Link ID.
3. Go to **Advanced > Network > Static Routing**.

Static Route						
						IPv4   IPv6
						+ Add - Delete
<input type="checkbox"/>	ID	Network Destination	Subnet Mask	Gateway	Status	Modify
--	--	--	--	--	--	--

4. Click **Add** to add a new static routing entry. Finish the settings according to the following explanations:

Static Route IPv4 | IPv6

+ Add - Delete

<input type="checkbox"/>	ID	Network Destination	Subnet Mask	Gateway	Status	Modify
--	--	--	--	--	--	--

Network Destination:

Subnet Mask:

Gateway:

Interface:

Enable This Entry

- **Network Destination** - The destination IP address that you want to assign to a static route. This IP address cannot be on the same subnet with the WAN IP or LAN IP of the router. In the example, the IP address of the company network is the destination IP address, so here enters 172.30.30.1.
  - **Subnet Mask** - Determines the destination network with the destination IP address. If the destination is a single IP address, enter 255.255.255.255; otherwise, enter the subnet mask of the corresponding network IP. In the example, the destination network is a single IP, so here enters 255.255.255.255.
  - **Gateway** - The IP address of the gateway device to which the data packets will be sent. This IP address must be on the same subnet with the router's IP which sends out the data. In the example, the data packets will be sent to the LAN port of Router 2 and then to the Server, so the gateway should be 192.168.1.2
  - **Interface** - Determined by the port that sends out the data packets. In the example, the data is sent to the gateway through the LAN port.
5. Select the checkbox to enable this entry.
  6. Click **Save** to save the settings.

## Done!

Open a web browser on your PC. Enter the company server's IP address to visit the company network.

## 11.8. Set up a VPN Connection

VPN (Virtual Private Network) is a private network established across the public network, generally via the internet. However, the private network is a logical network without any physical network lines, so it is called Virtual Private Network.

With the wide application of the internet, more and more data need to be shared through the internet. Connecting the local network to the internet directly, though can allow the data exchange, will cause the private data to be exposed to all the users on the internet.

### 11.8.1. Use OpenVPN to Access Your Home Network

In the OpenVPN connection, the home network can act as a server, and the remote device can access the server through the router which acts as an OpenVPN Server gateway. To use the VPN feature, you should enable OpenVPN Server on your router, and install and run VPN client software on the remote device. Please follow the steps below to set up an OpenVPN connection.

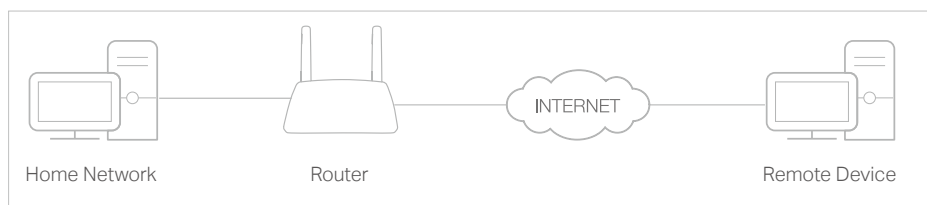

#### Step1. Set up OpenVPN Server on Your Router

1. Visit <http://tplinkmodem.net>, and log in with the password or your TP-Link ID.
2. Go to **Advanced > VPN Server > OpenVPN**, and select **Enable VPN Server**.

**OpenVPN**

**Note:** No certificate currently, please **Generate** one before enabling VPN Server.

**Enable VPN Server**

Service Type:  **UDP**  **TCP**

Service Port:

VPN Subnet/Netmask:

Client Access:  **Home Network Only**  **Internet and Home Network**

**Save**

**Note:**

- Before you enable VPN Server, we recommend you configure Dynamic DNS Service (recommended) or assign a static IP address for router's WAN port and synchronize your System Time with internet.
- The first time you configure the OpenVPN Server, you may need to **Generate** a certificate before you enable the VPN Server.

3. Select the **Service Type** (communication protocol) for OpenVPN Server: UDP, TCP.
4. Enter a VPN **Service Port** to which a VPN device connects, and the port number should be between 1024 and 65535.

5. In the **VPN Subnet/Netmask** fields, enter the range of IP addresses that can be leased to the device by the OpenVPN server.
6. Select your **Client Access** type. Select **Home Network Only** if you only want the remote device to access your home network; select **Internet and Home Network** if you also want the remote device to access internet through the VPN Server.
7. Click **Save**.
8. Click **Generate** to get a new certificate.

Certificate

---

Generate the certificate. Generate

**Note:**

If you have already generated one, please skip this step, or click **Generate** to update the certificate.

9. Click **Export** to save the OpenVPN configuration file which will be used by the remote device to access your router.

Configuration File

---

Export the configuration. Export

## Step 2. Configure OpenVPN Connection on Your Remote Device

1. Visit <http://openvpn.net/index.php/download/community-downloads.html> to download the OpenVPN software, and install it on your device where you want to run the OpenVPN client utility.

**Note:**

You need to install the **OpenVPN** client utility on each device that you plan to apply the VPN function to access your router. Mobile devices should download a third-party app from Google Play or Apple App Store.

2. After the installation, copy the file exported from your router to the OpenVPN client utility's "config" folder (for example, **C:\Program Files\OpenVPN\config** on Windows). The path depends on where the OpenVPN client utility is installed.
3. Run the OpenVPN client utility and connect it to OpenVPN Server.

### 11. 8. 2. Use PPTP VPN to Access Your Home Network

PPTP VPN Server is used to create a VPN connection for remote device. To use the VPN feature, you should enable PPTP VPN Server on your router, and configure the PPTP connection on the remote device. Please follow the steps below to set up a PPTP VPN connection.

#### Step 1. Set up PPTP VPN Server on Your Router

1. Visit <http://tplinkmodem.net>, and log in with the password or your TP-Link ID.
2. Go to **Advanced > VPN Server > PPTP VPN**, and select **Enable VPN Server**.

**PPTP VPN**

**Enable VPN Server**

Client IP Address:  -10.7.0.  (up to 10 clients)

Username:

Password:

[Save](#)

**Note:**

Before you enable [VPN Server](#), we recommend you configure [Dynamic DNS Service](#) (recommended) or assign a static IP address for router's WAN port and synchronize your [System Time](#) with internet.

3. In the [Client IP Address](#) filed, enter the range of IP addresses (up to 10) that can be leased to the devices by the PPTP VPN server.
4. In the [Username/Password](#) filed, enter the username and password to authenticate clients to the PPTP VPN server.
5. Click [Save](#).

## Step 2. Configure PPTP VPN Connection on Your Remote Device

The remote device can use the Windows built-in PPTP software or a third-party PPTP software to connect to PPTP Server. Here we use the [Windows built-in PPTP software](#) as an example.

1. Go to [Start > Control Panel > Network and Internet > Network and Sharing Center](#).
2. Select [Set up a new connection or network](#).

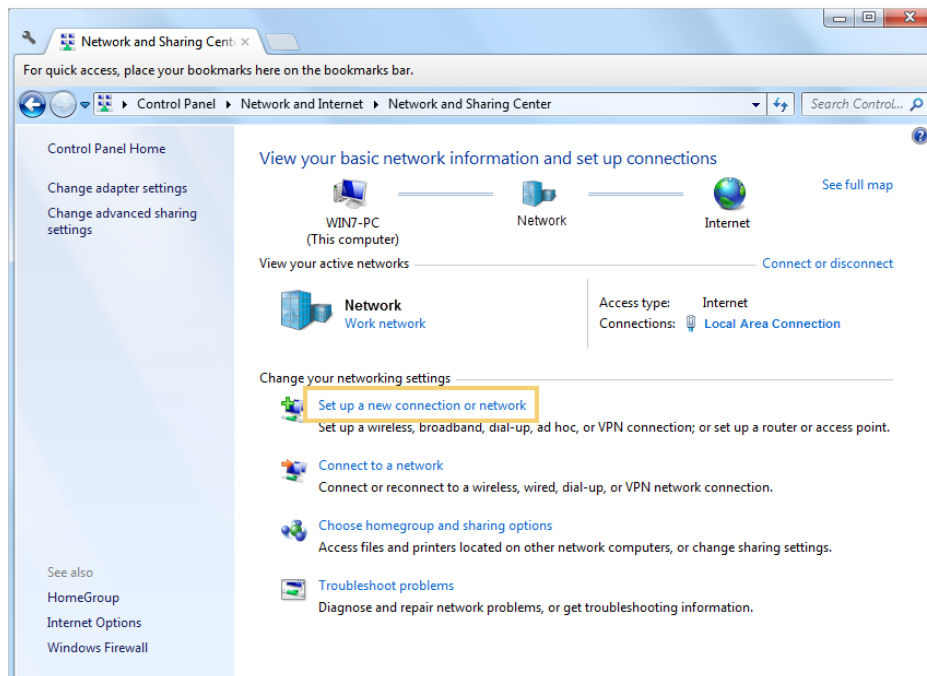



3. Select **Connect to a workplace** and click **Next**.

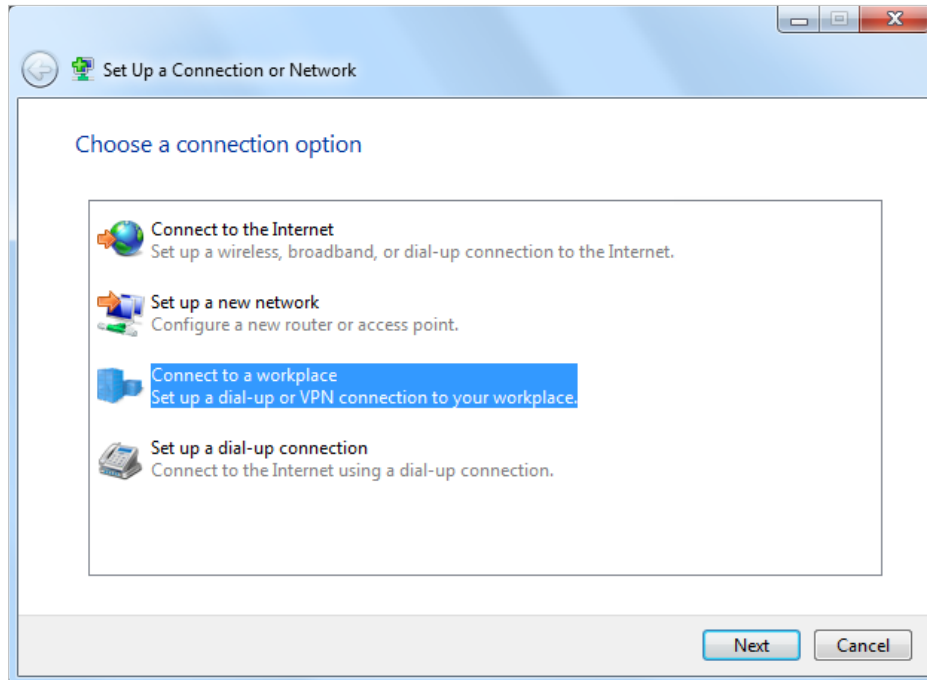

4. Select **Use my Internet connection (VPN)**.

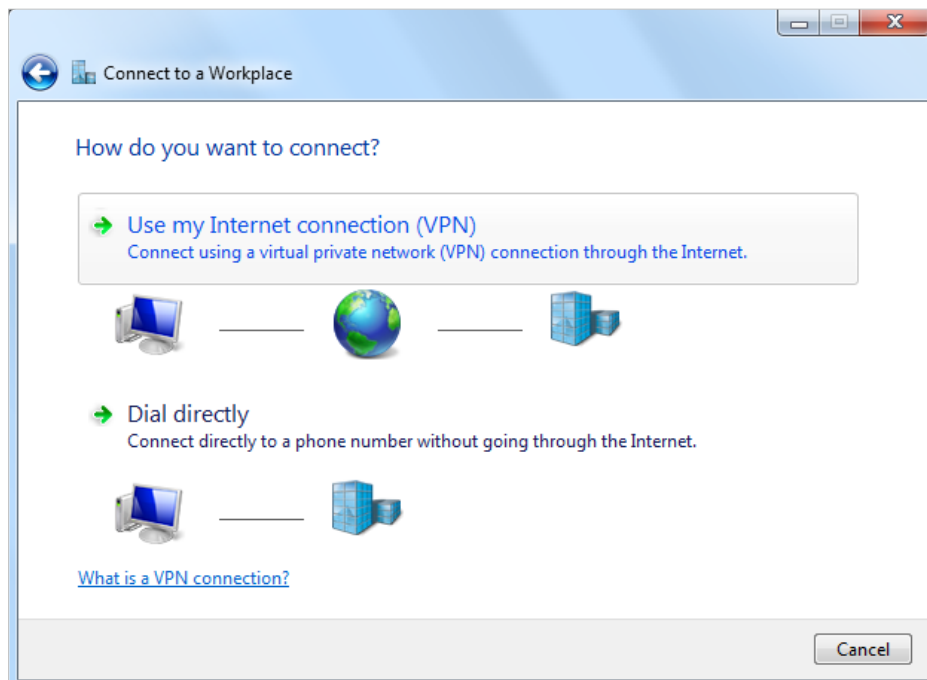

5. Enter the internet IP address of the router (for example: 218.18.1.73) in the **Internet address** field. Click **Next**.

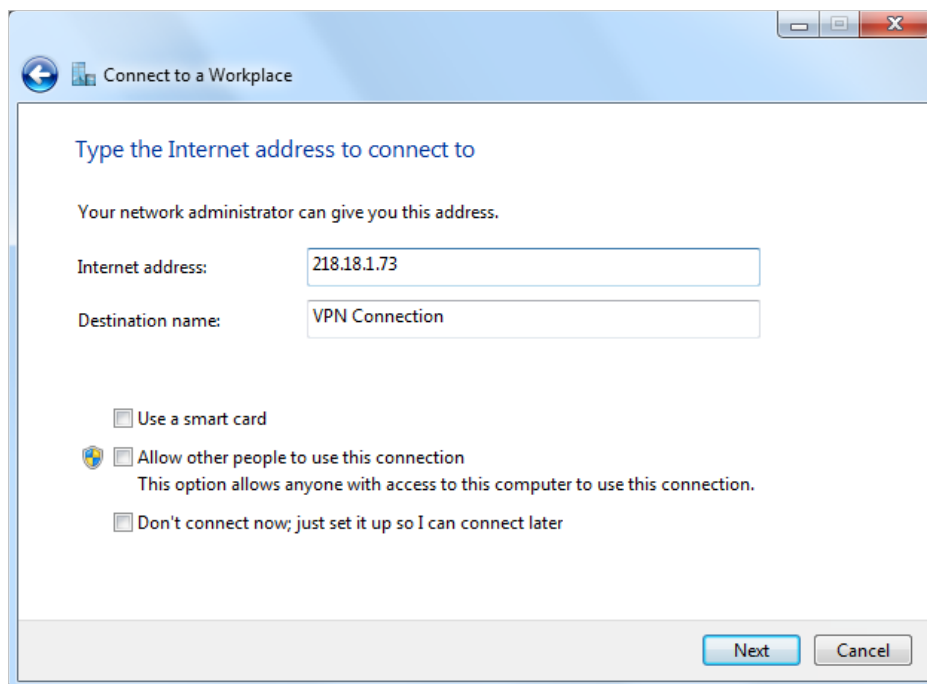

6. Enter the **User name** and **Password** you have set for the PPTP VPN server on your router, and click **Connect**.

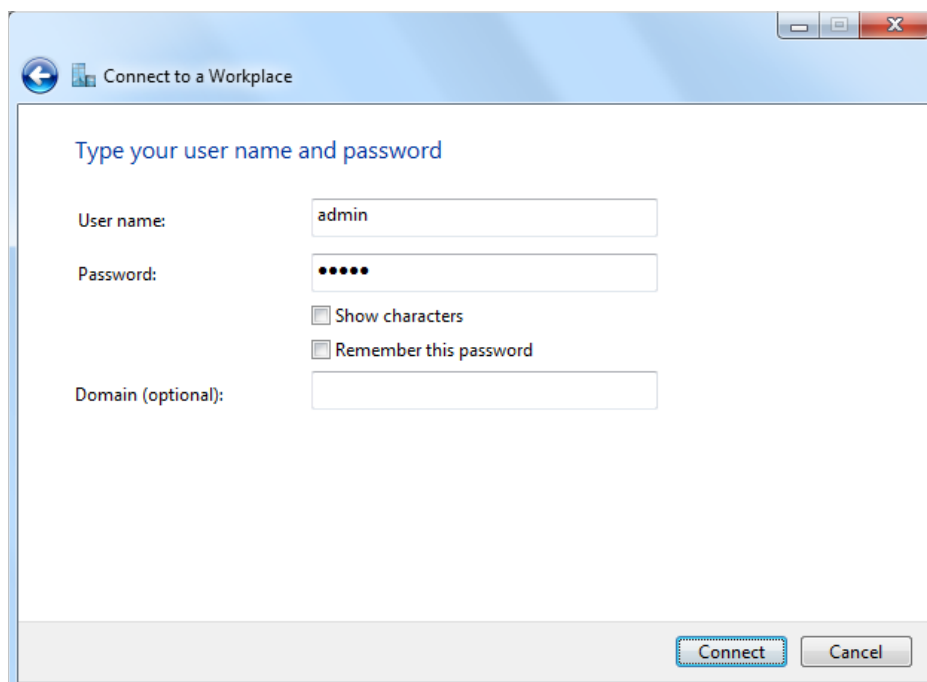

7. The PPTP VPN connection is created and ready to use.

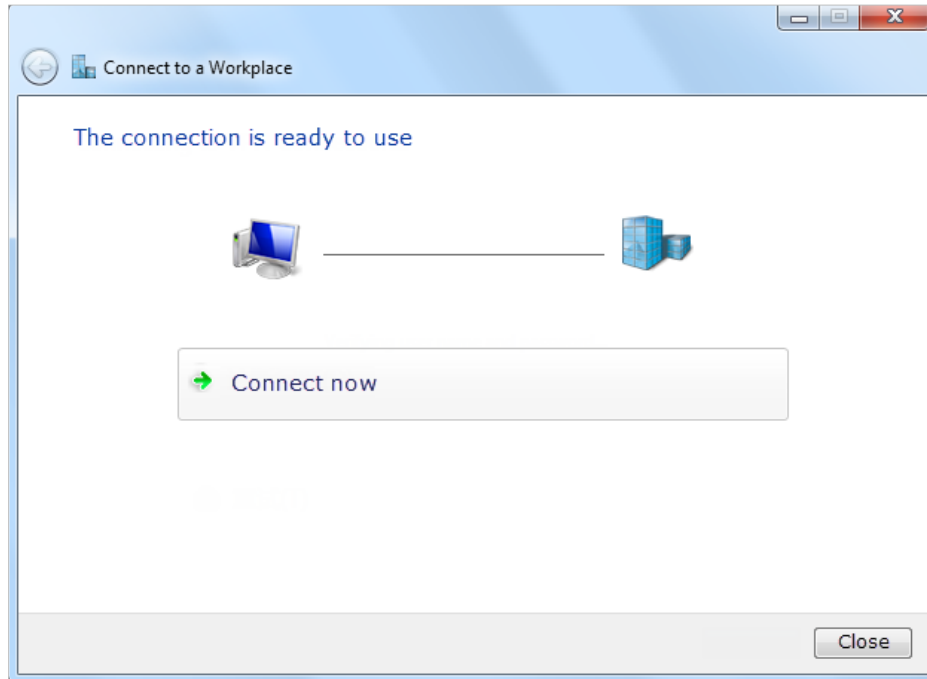

## 11.9. USSD

USSD (Unstructured Supplementary Service Data) is used to communicate with the service provider's computer. You can query service data on this page.

Follow the steps below to get service data.

1. Visit <http://tplinkmodem.net>, and log in with the password or your TP-Link ID.
2. Go to [Advanced](#) > [Network](#) > [USSD](#) page.

3. Enter the USSD request and click [Send](#). You will see the message returned from the carrier in the [USSD Result](#) box.

## Chapter 12

---

# Administrate Your Network

---

This chapter introduces how to change the system settings and administrate your router's network.

This chapter contains the following sections:

- [Set System Time](#)
- [Control LEDs](#)
- [Test the Network Connectivity](#)
- [Update the Firmware](#)
- [Back up and Restore Configuration Settings](#)
- [Set the Router to Reboot Regularly](#)
- [Change the Administrator Account](#)
- [Local Management](#)
- [Remote Management](#)
- [System Log](#)
- [CWMP Settings](#)
- [SNMP Settings](#)
- [Monitor the Internet Traffic Statistics](#)

## 12.1. Set System Time

System time is the time displayed while the router is running. The system time you configure here will be used for other time-based functions like Parental Controls and Wireless Schedule. You can manually set how to get the system time.

Follow the steps below to set your system time.

1. Visit <http://tplinkmodem.net>, and log in with the password or your TP-Link ID.
2. Go to **Advanced > System Tools > Time Settings** page.

The screenshot shows the 'System Time' configuration page. It includes the following fields and controls:

- Current Time:** A text field showing the current system time.
- Time Zone:** A dropdown menu with a list of time zones.
- Date:** A text field for the date in DD/MM/YY format.
- Time:** Three dropdown menus for hours (10), minutes (0), and seconds (41).
- NTP Server I:** A text field with '0.0.0.0' and '(Optional)' label.
- NTP Server II:** A text field with '0.0.0.0' and '(Optional)' label.
- Buttons:** 'Get from PC', 'Get from the Internet', and 'Save'.

3. Configure the system time using the following methods :
  - Manually** - Select your time zone and enter your local time.
  - Get from PC** - Click this button if you want to use the current managing PC's time.
  - Get from the Internet** - Click this button if you want to get time from the internet. Make sure your router can access the internet before you select this way to get system time.
4. Click **Save** to make your settings effective.
5. After setting the system time, you can set **Daylight Saving** time according to your needs. Tick the checkbox to enable **Daylight Saving**, set the start and end time and then click **Save** to make the settings effective.

The screenshot shows the 'Daylight Saving Time' configuration page. It includes the following fields and controls:

- Enable Daylight Saving Time:** A checked checkbox.
- Start:** A row of dropdowns for month (Mar), day (Last), and time (02:00).
- End:** A row of dropdowns for month (Oct), day (Last), and time (03:00).
- Button:** 'Save'.

## 12.2. Control LEDs

The router's LEDs indicate router's activities and status. You can turn on or turn off the LEDs as you need.

- **To turn off LEDs:**

1. Visit <http://tplinkmodem.net>, and log in with the password or your TP-Link ID.
2. Go to [Advanced](#) > [System Tools](#) > [LED Control](#) page.
3. Disable [LED Status](#).

- **To turn off LEDs during the specified period :**

1. Visit <http://tplinkmodem.net>, and log in with the password or your TP-Link ID.
2. Go to [Advanced](#) > [System Tools](#) > [LED Control](#) page.
3. Tick the [Night Mode](#) checkbox.
4. Specify a time period in the [LED Off Time](#) as needed, and the LEDs will be off during this period.

■ **Note:** Once Night Mode is enabled, the LEDs will be off during the specified period everyday without affecting the router's performance.

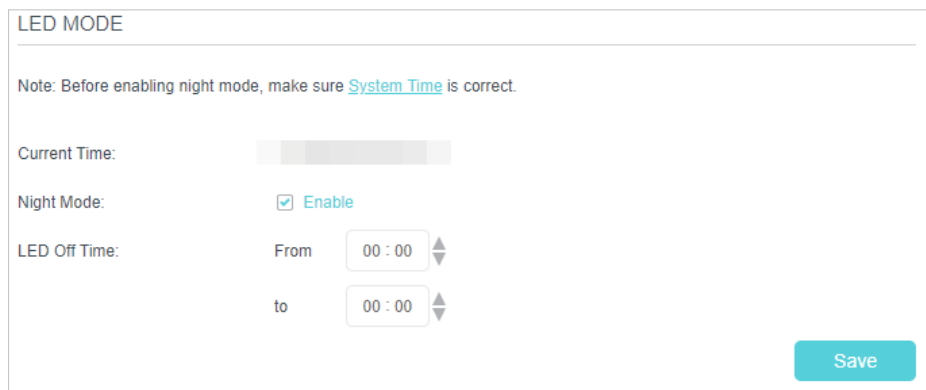

LED MODE

Note: Before enabling night mode, make sure [System Time](#) is correct.

Current Time:

Night Mode:  Enable

LED Off Time: From  to

Save

## 12.3. Test the Network Connectivity

Diagnostics feature helps you run diagnostic test and troubleshoot your network connectivity problems.

1. Visit <http://tplinkmodem.net>, and log in with the password or your TP-Link ID.
2. Go to [Advanced](#) > [System Tools](#) > [Diagnostic](#) page.
3. Click the [Start](#) button to test the Internet connection of the router.

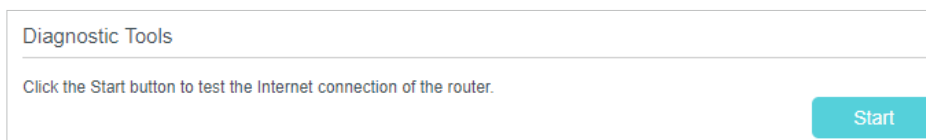

Diagnostic Tools

Click the Start button to test the Internet connection of the router.

Start

## 12.4. Update the Firmware

TP-Link is dedicated to improving and enriching the product features, giving you a better network experience.

We will inform you through the web management page if there's any update firmware available for your router. Also, the latest firmware will be released at TP-Link official website, you can download it from the [Support](#) page of our website [www.tp-link.com](http://www.tp-link.com) for free.

### Note:

1. Make sure that you have a stable connection between the router and your computer. It is NOT recommended to upgrade the firmware wirelessly.
2. Make sure you remove any USB storage device connected to the router before the firmware upgrade to prevent data loss.
3. Back up your router configuration before upgrading the firmware.
4. Do NOT turn off the router during the firmware upgrade.

### 12.4.1. Online Upgrade

1. Visit <http://tplinkmodem.net>, and log in with the password or your TP-Link ID.
2. If there's any firmware update available for your router, the update icon  will display on the top-right corner of the page. Click the icon to go to the [Firmware Upgrade](#) page. Alternatively, you can go to [Advanced](#) > [System Tools](#) > [Firmware Upgrade](#), and click [Check for Upgrades](#) to see if there's any new firmware.

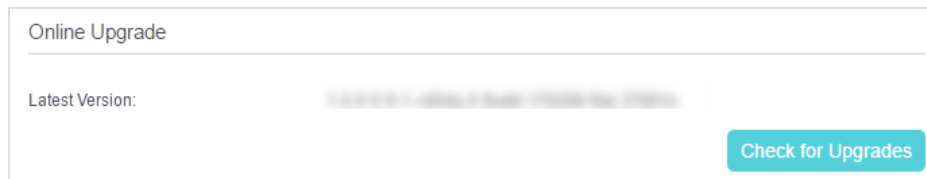

### Tips:

If there's any new important firmware update for your router, you will see the notification (similar as shown below) on your computer when open a new web page. Click [Upgrade Now](#), and log in to the web management page. You will see the [Firmware Upgrade](#) page.

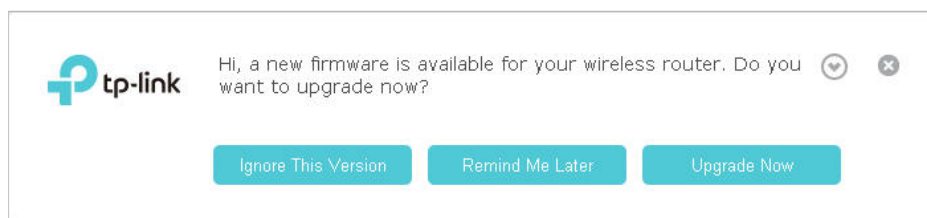

3. Focus on the **Online Upgrade** section, and click **Upgrade**.

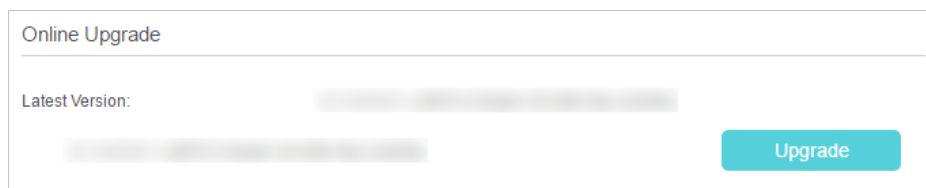

Online Upgrade

Latest Version: [blurred]

[blurred]

Upgrade

4. Wait a few moments for the upgrading and rebooting.

### 12.4.2. Local Upgrade

1. Download the latest firmware file for the router from our website [www.tp-link.com](http://www.tp-link.com).
2. Visit <http://tplinkmodem.net>, and log in with the password or your TP-Link ID.
3. Go to **Advanced > System Tools > Firmware Upgrade**.
4. Focus on the Device Information section. Make sure the downloaded firmware file matches with the **Hardware Version**.
5. Focus on the **Local Upgrade** section. Click **Browse** to locate the downloaded new firmware file, and click **Upgrade**.

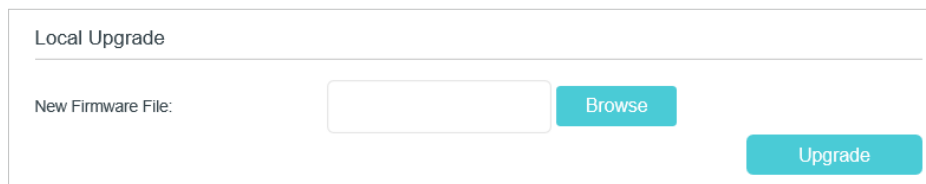

Local Upgrade

New Firmware File:

Browse

Upgrade

6. Wait a few moments for the upgrading and rebooting.

## 12.5. Back up and Restore Configuration Settings

The configuration settings are stored as a configuration file in the router. You can back up the configuration file to your computer for future use and restore the router to a previous settings from the backup file when needed. Moreover, if needed you can erase the current settings and reset the router to the default factory settings.

- **To back up configuration settings:**
  1. Visit <http://tplinkmodem.net>, and log in with the password or your TP-Link ID.
  2. Click **Advanced > System Tools > Backup & Restore** page.
  3. Click **Backup** to save a copy of the current settings to your local computer. A conf. bin file will be stored to your computer.



- **To restore configuration settings:**

1. Visit <http://tplinkmodem.net>, and log in with the password or your TP-Link ID.
2. Click [Advanced](#) > [System Tools](#) > [Backup & Restore](#) page.

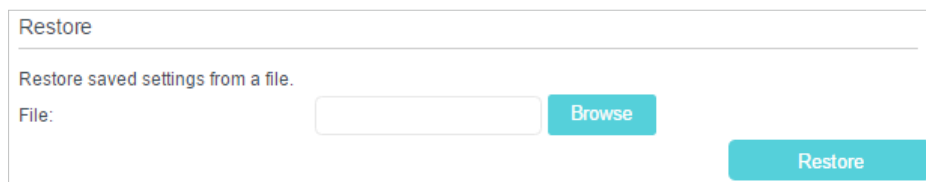

The screenshot shows a web interface titled "Restore". Below the title, it says "Restore saved settings from a file." There is a "File:" label followed by an empty text input field. To the right of the input field is a teal "Browse" button. Further to the right is a larger teal "Restore" button.

3. Click [Browse](#) to locate the previous backup configuration file, and click [Restore](#).
4. Wait for the restoring and then the router will automatically reboot.

- **To reset the router to factory default settings:**

1. Visit <http://tplinkmodem.net>, and log in with the password or your TP-Link ID.
2. Click [Advanced](#) > [System Tools](#) > [Backup & Restore](#) page.

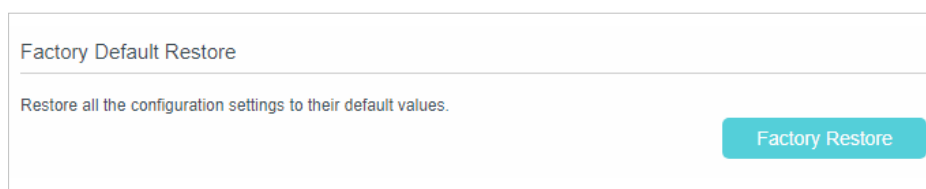

The screenshot shows a web interface titled "Factory Default Restore". Below the title, it says "Restore all the configuration settings to their default values." There is a single teal "Factory Restore" button on the right side of the page.

3. Click [Factory Restore](#) to reset the router.
4. Wait for the resetting and then the router will automatically reboot.

📌 **Note:**

1. Do not interrupt or turn off the router during the resetting process.
2. We strongly recommend you to back up the current configuration settings before resetting the router.

## 12.6. Set the Router to Reboot Regularly

The Reboot Schedule feature cleans the cache to enhance the running performance of the router. You can reboot the router manually or set it to reboot regularly.

The screenshot shows a web interface for configuring the router's reboot settings. It is divided into two sections: "Manual Reboot" and "Reboot Schedule".

- Manual Reboot:** A simple section with a single teal "Reboot" button.
- Reboot Schedule:** A section for scheduling automatic reboots. It includes a note: "Note: Before enabling Reboot Schedule, please make sure the [System Time](#) is correct." Below the note are several fields:
  - Current Time:** A greyed-out field.
  - Reboot Schedule:** A checkbox labeled "Enable" which is currently unchecked.
  - Reboot Time:** A time selection field showing "03 : 00".
  - Repeat:** A dropdown menu currently set to "Every Day".

At the bottom right of the "Reboot Schedule" section is a teal "Save" button.

- **To reboot manually:**
  1. Visit <http://tplinkmodem.net>, and log in with the password or your TP-Link ID.
  2. Go to [Advanced](#) > [System Tools](#) > [Reboot](#) page.
  3. Click [Reboot](#) and wait a few minutes for the router to restart.
- **To schedule the reboot time**
  1. Visit <http://tplinkmodem.net>, and log in with the password or your TP-Link ID.
  2. Go to [Advanced](#) > [System Tools](#) > [Reboot](#) page.
  3. Enable [Reboot Schedule](#).
  4. Set when and how often the router reboots by specifying the parameters in the [Reboot Time](#) and [Repeat](#) fields.
  5. Click [Save](#).

## 12.7. Change the Administrator Account

Admin account is used to log in to the router's web-based management page. You are required to set the admin account at the first login. You can change it on the web page.

1. Visit <http://tplinkmodem.net>, and log in with the password or your TP-Link ID.
2. Go to [Advanced](#) > [System Tools](#) > [Administration](#) page. Locate the [Account Management](#) section.

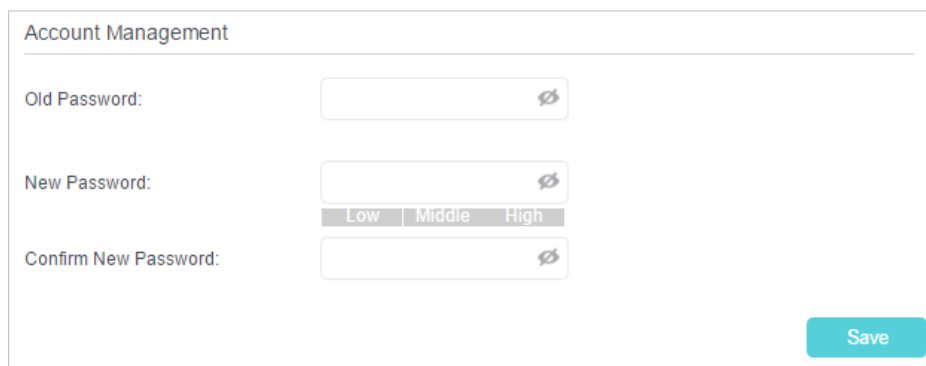

Account Management

Old Password:

New Password:  Low Middle High

Confirm New Password:

Save

3. Enter the old password. Enter the new password and enter again to confirm.
4. Click [Save](#) to make the settings effective.

## 12.8. Local Management

You can control the local devices' authority to manage the router via the Local Management feature. By default all local connected devices are allowed to manage the router. You can also allow only one device to manage the router.

Follow the steps below to specify the local management.

1. Visit <http://tplinkmodem.net>, and log in with the password or your TP-Link ID.
2. Go to [Advanced](#) > [System Tools](#)> [Administration](#) page. Locate the [Local Management](#) section.

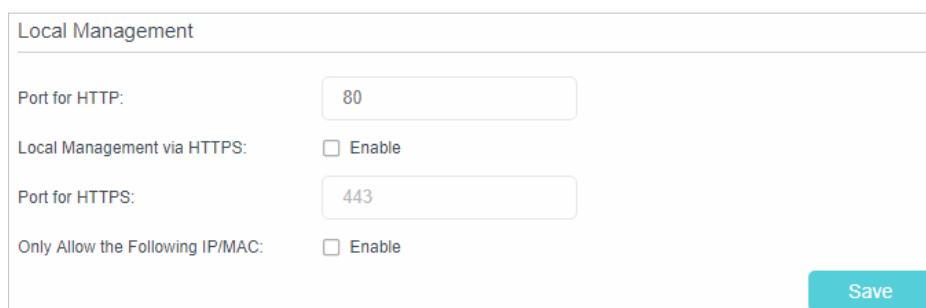

Local Management

Port for HTTP:

Local Management via HTTPS:  Enable

Port for HTTPS:

Only Allow the Following IP/MAC:  Enable

Save

3. Enable Local Management via HTTPS if you want to access the router via both HTTPS and HTTP, or keep it disabled if you only want to access the router via HTTP.
4. Keep the Port for HTTP and Port for HTTPS as the default settings.
5. If you only want to allow one specific device to manage the router, enable [Only Allow the Following IP/MAC](#) and then enter the [IP Address](#) or [MAC Address](#) of the device in the IP/MAC Address field.
6. Click [Save](#) to make the settings effective.

## 12.9. Remote Management

By default, the remote devices are not allowed to manage the router from the internet. Follow the steps below to allow remote devices to manage the router.

1. Visit <http://tplinkmodem.net>, and log in with the password or your TP-Link ID.
2. Go to [Advanced](#) > [System Tools](#) > [Administration](#) page. Locate the [Remote Management](#) section.

The screenshot shows the 'Remote Management' configuration page. At the top, there is a note: 'Note: Remote Management is not supported when you are connected to the internet only via IPv6. If you want to use Remote Management, please make sure you have set up an IPv4 connection first.' Below the note, there are several settings: 'Remote Management' with an unchecked 'Enable' checkbox; 'Remote Management via HTTPS' with a checked 'Enable' checkbox; 'Port' set to '443'; and 'Manage This Router via the Address:' with a text box containing 'Your router is not connected to the internet via IPv4.'. Underneath, there is a section for 'Client Device Allowed for Remote Management' with two radio button options: 'Only the Following IP/MAC Address' (unselected) and 'All' (selected). A 'Save' button is located at the bottom right of the form.

3. Enable [Remote Management](#) if you want to allow Remote Management via HTTPS, or enable [Remote Management](#) and then disable Remote Management via HTTPS if you only want to allow Remote Management via HTTP.
4. Keep the [Port](#) as the default setting.
5. If you only want to allow one specific device to manage the router, select [Only the Following IP/MAC Address](#) and then enter the [IP Address](#) or [MAC Address](#). If you want to allow all remote devices can access the router, select [All](#).
6. Click [Save](#) to make the settings effective.

**Tips:**

1. You can find the WAN IP address of the router on [Basic](#) > [Network Map](#) > [Internet](#).
2. The router's WAN IP is usually a dynamic IP. Please refer to [Set Up a Dynamic DNS Service Account](#) if you want to log in to the router through a domain name.

## 12. 10. System Log

System Log can help you know what happens to your router, facilitating you to locate the malfunctions. For example when your router does not work properly, you will need to save the system log and send it to the technical support for troubleshooting.

1. Visit <http://tplinkmodem.net>, and log in with the password or your TP-Link ID.
2. Click [Advanced](#) > [System Tools](#) > [System Log](#) page.

**System Log**

Type:

Level:

[Refresh](#) [Delete All](#)

ID	Time	Type	Level	Log Content
1		DHCPD	Notice	Send ACK to 192.168.1.100
2		DHCPD	Notice	Recv REQUEST from 40:8D:5C:89:74:B5
3		DHCPD	Notice	Send OFFER with ip 192.168.1.100
4		DHCPD	Notice	Recv DISCOVER from 40:8D:5C:89:74:B5
5		SYSTEM	Notice	Enable access control

- **To view the system logs:**

1. Select the log Type. Select [ALL](#) to view all kinds of logs, or select [DHCPD](#) or [IGMP](#) to view the specific logs.
2. Select the log Level and you will see the logs with the specific or higher levels.
3. Click [Refresh](#) to refresh the log list.

- **To save the system logs:**

You can choose to save the system logs to your local computer or a remote server.

1. Click [Save Log](#) to save the logs in a txt file to your computer.
2. Click [Log Settings](#) to set the save path of the logs.

Log Settings

Save Locally

Minimum Level: Information

Save Remotely

Minimum Level: Warning

Server IP: 192.168.1.100

Server Port: 514

Local Facility Name: User

Back Save

- **Save Locally** - Select this option to cache the system log to the router's local memory, select the minimum level of system log to be saved from the drop-down list. The logs will be shown in the table in descending order on the System Log page.
- **Save Remotely** - Select this option to send the system log to a remote server, select the minimum level of system log to be saved from the drop-down list and enter the information of the remote server. If the remote server has a log viewer client or a sniffer tool implemented, you can view and analyze the system log remotely in real-time.

## 12. 11. CWMP Settings

The router offers CWMP feature. The function supports TR-069 protocol which collects information, diagnoses the devices and configures the devices automatically via ACS (Auto-Configuration Server).

1. Visit <http://tplinkmodem.net>, and log in with the password or your TP-Link ID.

CWMP Settings

CWMP:

Inform:

Inform Interval:  (seconds)

ACS URL:

ACS Username:

ACS Password:

Interface used by TR-069 client:

Display SOAP messages on serial console:

Connection Request Authentication

Username:

Password:

Path:

Port:

URL:

2. Go to **Advanced** > **System Tools** > **CWMP Settings** page.

- **Enable CWMP** - Toggle On to enable the CWMP (CPE WAN Management Protocol) feature.
- **Inform** - Enable this feature to send an Inform message to the ACS (Auto Configuration Server) periodically.
- **Inform Interval** - Enter the time in seconds when the Inform message will be sent to the ACS.
- **ACS URL** - Enter the web address of the ACS which is provided by your ISP.
- **ACS Username/Password** - Enter the username/password to log in to the ACS server.
- **Interface used by TR-069 client** - Select which interface to be used by the TR-069 client.
- **Display SOAP messages on serial console** - Toggle to enable or disable this feature.

- **Connection Request Authentication** - Select this checkbox to enable authentication for the connection request.
  - **Username/Password** - Enter the username/password for the ACS server to log in to the router.
  - **Path** - Enter the path for the ACS server to log in to the router.
  - **Port** - Enter the port that connects to the ACS server.
  - **URL** - Enter the URL that connects to the ACS server.
  - **Get RPC Methods** - Click to get the methods to support CWMP.
3. Click **Save** to make the settings effective.

## 12. 12. SNMP Settings

SNMP (Simple Network Management Protocol) has been widely applied in the computer networks currently, which is used for ensuring the transmission of the management information between two nodes. In this way, network administrators can easily search and modify the information on any node on the network. Meanwhile, they can locate faults promptly and implement the fault diagnosis, capacity planning and report generating.

An **SNMP Agent** is an application running on the router that performs the operational role of receiving and processing SNMP messages, sending responses to the SNMP manager, and sending traps when an event occurs. So a router contains SNMP "agent" software can be monitored and/or controlled by SNMP Manager using SNMP messages.

1. Visit <http://tplinkmodem.net>, and log in with the password or your TP-Link ID.
2. Go to **Advanced > System Tools > SNMP Settings** page.

SNMP Settings

SNMP Agent:

SNMP Agent for WAN:

Read-only Community:

Write Community:

System Name:

System Description:

System Location:

System Contact:

Trap Manager IP:

**Save**



- **Enable SNMP Agent/SNMP Agent for WAN** - Toggle On to enable the built-in SNMP agent that allows the router to operate as the operational role in receiving and processing of SNMP messages, sending responses to the SNMP manager, and triggering SNMP traps when an event occurs.
  - **Read-only Community** - Displays the default public community string that protects the router from unauthorized access.
  - **Write Community** - Displays the default read and write community string that protects the router from unauthorized changes.
  - **System Name** - Displays the administratively-assigned name for this managed device.
  - **System Description** - Displays the textual description of the managed device. This value should include the full name and version identification of the system's hardware type, software operating-system, and networking software.
  - **System Location** - Displays the physical location of this device (e.g. telephone closet, 3rd floor).
  - **System Contact** - Displays the textual identification of the contact person for this managed device, together with information on how to contact this person.
  - **Trap Manager IP** - Displays the IP address of the host to receive the traps.
3. It is recommended to keep the default settings. Click **Save** to make the settings effective.

## 12. 13. Monitor the Internet Traffic Statistics

The Traffic Monitor page displays the network traffic of the LAN, WAN and WLAN sent and received packets, allowing you to monitor the volume of internet traffic statistics.

1. Visit <http://tplinkmodem.net>, and log in with the password or your TP-Link ID.
2. Go to **Advanced > System Tools > Traffic Monitor** page.
3. Toggle on **Traffic Monitor**, and then you view the traffic usage of a device in the past 10 minutes or that of all devices in the past 10 minutes/24 hours/7 days.

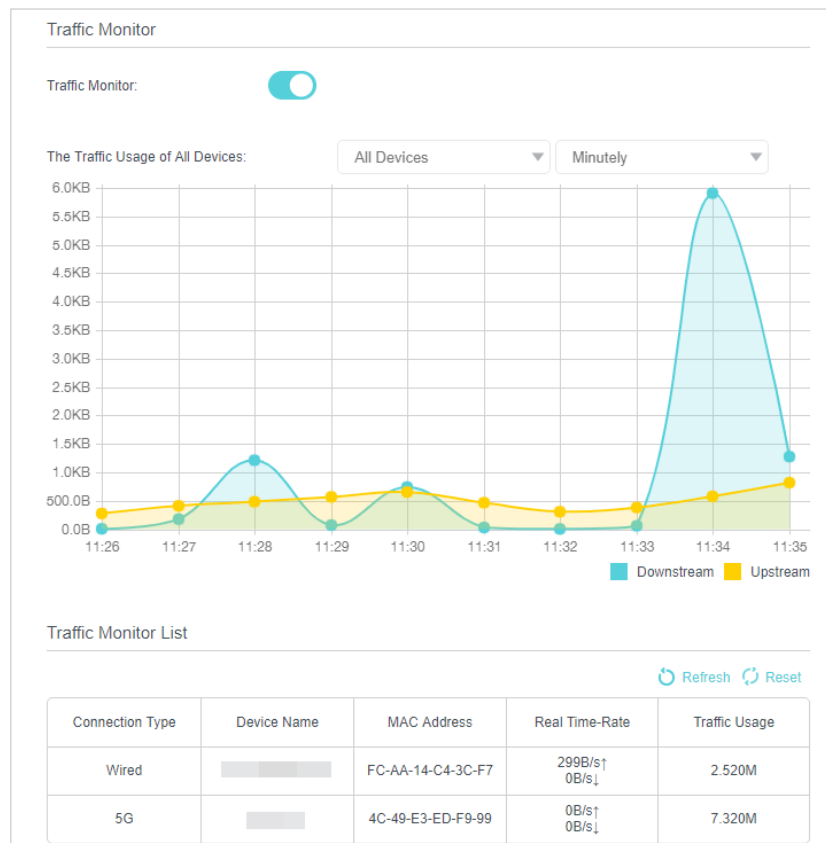

## Chapter 13

---

# TP-Link Cloud Service

---

TP-Link Cloud service provides a better way to manage your cloud devices. Log in to your router with a TP-Link ID, and you can easily monitor and manage your home network when you are out and about via the Tether app on your smartphone or tablet. To ensure that your router stays new and gets better over time, the TP-Link Cloud will notify you when an important firmware upgrade is available. Surely you can also manage multiple TP-Link Cloud devices with a single TP-Link ID.

This chapter introduces how to register a new TP-Link ID, bind or unbind TP-Link IDs to manage your router, and the Tether app with which you can manage your home network no matter where you may find yourself.

It contains the following sections:

- [Register a TP-Link ID](#)
- [Change Your TP-Link ID Information](#)
- [Manage the User TP-Link IDs](#)
- [Manage the Router via the TP-Link Tether App](#)

## 13.1. Register a TP-Link ID

If you have skipped the registration during the Quick Setup process, you can:

Visit <http://tplinkmodem.net>, and log in with the password or your TP-Link ID.

1. Go to [Basic > TP-Link Cloud](#).
2. Click [Register Now](#) and follow the instructions to register a TP-Link ID.

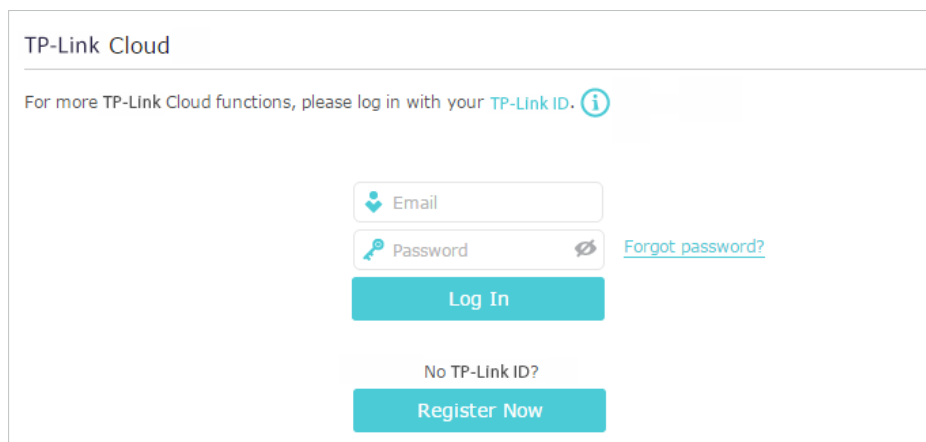

3. After activating your TP-Link ID, come back to the TP-Link Cloud page to log in. The TP-Link ID used to log in to the router for the first time will be automatically bound as an [Admin](#).

■ Note:

- To learn more about the [Admin](#) and [User](#) TP-Link ID, refer to [Manage the User TP-Link IDs](#).
- Once the router is bound to your TP-Link ID, you need to log in to the router with the TP-Link ID.
- Once you have registered a TP-Link ID on the web management page, you can only register another TP-Link ID via the Tether APP. Please refer to [Manage the Router via the TP-Link Tether App](#) to install the app and register a new one.
- If you want to unbind the admin TP-Link ID from your router, please go to [Basic > TP-Link Cloud](#), and click [Unbind](#) in the [Device Information](#) section.

## 13.2. Change Your TP-Link ID Information

Follow the steps below to change your email address and password of your TP-Link ID as needed.

1. Visit <http://tplinkmodem.net>, and log in with your TP-Link ID.
2. Go to [Basic > TP-Link Cloud](#), and focus on the [Account Information](#) section.

- **To change your email address:**

1. Click  behind the Email.
2. Enter the password of your TP-Link ID, then a new email address. And click [Save](#).

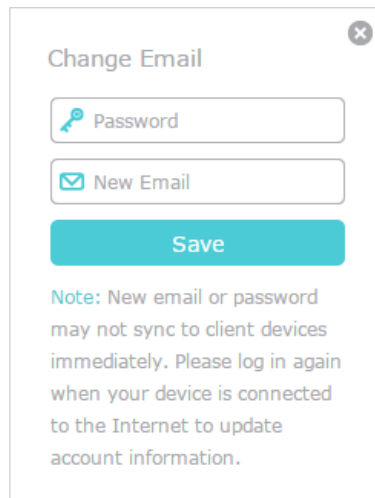

Change Email

Password

New Email

Save

Note: New email or password may not sync to client devices immediately. Please log in again when your device is connected to the Internet to update account information.

- **To change your password:**

1. Click  behind the Password.
2. Enter the current password, then a new password twice. And click [Save](#).

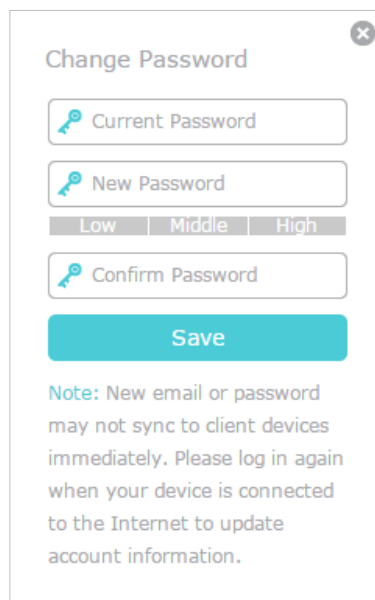

Change Password

Current Password

New Password

Low Middle High

Confirm Password

Save

Note: New email or password may not sync to client devices immediately. Please log in again when your device is connected to the Internet to update account information.

### 13.3. Manage the User TP-Link IDs

The TP-Link ID used to log in to the router for the first time will be automatically bound as the [Admin](#) account. An admin account can add or remove other TP-Link IDs to or from the same router as [Users](#). All accounts can monitor and manage the router locally or remotely, but user accounts cannot:

- Reset the router to its factory default settings either on the web management page or in the Tether app.

- Add/remove other TP-Link IDs to/from the router.

### 13.3.1. Add TP-Link ID to Manage the Router

1. Visit <http://tplinkmodem.net>, and log in with your TP-Link ID.
2. Go to **Basic** > **TP-Link Cloud**, and focus on the **Bound Accounts** section.
3. Click **+ Bind**, enter another TP-Link ID as needed and click **Save**.

**Note:**

If you need another TP-Link ID, please register a new one via the Tether app. Please refer to [Manage the Router via the TP-Link Tether App](#) to install the app and register a new TP-Link ID.

4. The new TP-Link ID will be displayed in the Bound Accounts table as a **User**.

Bound Accounts				
<span style="color: teal;">+</span> Bind <span style="color: red;">-</span> Unbind				
<input type="checkbox"/>	ID	Email	Binding Date	Role
<input type="checkbox"/>	1	*****@*****.com	*****	Admin
<input type="checkbox"/>	2	*****@*****.com	*****	User

### 13.3.2. Remove TP-Link ID(s) from Managing the Router

1. Visit <http://tplinkmodem.net>, and log in with your TP-Link ID.
2. Go to **Basic** > **TP-Link Cloud**, and focus on the **Bound Accounts** section.
3. Tick the checkbox(es) of the TP-Link ID(s) you want to remove and click **Unbind**.

Bound Accounts				
<span style="color: teal;">+</span> Bind <span style="color: red;">-</span> Unbind				
<input type="checkbox"/>	ID	Email	Binding Date	Role
<input type="checkbox"/>	1	*****@*****.com	*****	Admin
<input checked="" type="checkbox"/>	2	*****@*****.com	*****	User

## 13.4. Manage the Router via the TP-Link Tether App

The Tether app runs on iOS and Android devices, such as smartphones and tablets.

1. Launch the Apple App Store or Google Play store and search “TP-Link Tether” or simply scan the QR code to download and install the app.



2. Connect your device to the router’s wireless network.
3. Launch the Tether app, select the model of your router and log in with your TP-Link ID or the password your set for the router.
4. Manage your router as needed.

■ Note:

If you need to remotely access your router from your smart devices, you need:

- Log in with your TP-Link ID. If you don’t have one, refer to [Register a TP-Link ID](#).
- Make sure your smartphone or tablet can access the internet with cellular data or a Wi-Fi network.

## Chapter 14

---



# OneMesh with Seamless Roaming

---

This chapter introduces the TP-Link OneMesh™ feature.

- [Set Up a OneMesh Network](#)
- [Manage Devices in the OneMesh Network](#)



TP-Link OneMesh  router and TP-Link OneMesh  extenders work together to form one unified Wi-Fi network. Walk through your home and stay connected with the fastest possible speeds thanks to OneMesh's seamless coverage.

### Unified Wi-Fi Network

Router and extenders share the same wireless settings, including network name, password, access control settings and more.

### Seamless Roaming

Devices automatically switch between your router and extenders as you move through your home for the fastest possible speeds.

### Easy Setup and Management

Set up a OneMesh network with a push of WPS buttons. Manage all network devices on the Tether app or at your router's web management page.

To check full list of TP-Link OneMesh devices, scan the QR code, or visit <https://www.tp-link.com/One-Mesh/compatibility>.



## Unified OneMesh Network

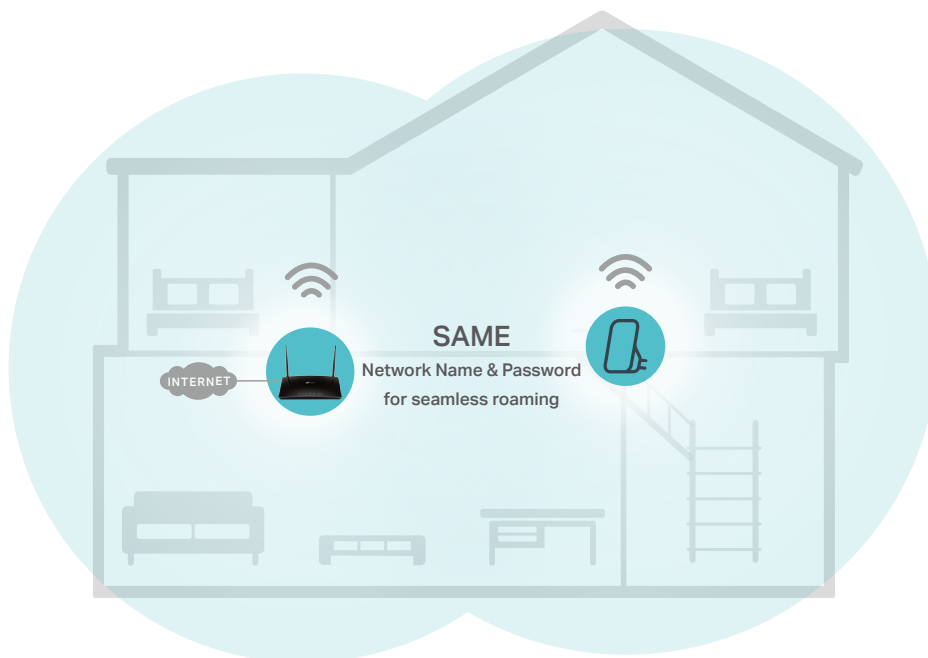

## 14. 1. Set Up a OneMesh Network

TP-Link OneMesh extender will automatically join the router's OneMesh network once connected. Check on the router's web management page to see if the OneMesh network is well-configured.

- **If the extender is connected to this router:**

1. Visit <http://tplinkmodem.net>, and log in with your TP-Link ID or the password you set for the router.
2. Go to **Basic > OneMesh** or **Advanced > OneMesh**.
3. When an extender joins the OneMesh network, it will be listed in the **Devices in OneMesh Network** list. Otherwise, you need to find it in the **Available OneMesh Devices** list and click **Add** to add it to the OneMesh network.

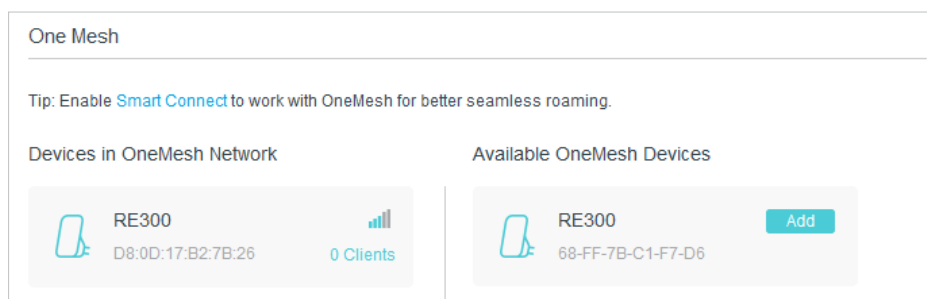

Now your router and extenders successfully form one OneMesh network!

- **Tips:**

It is recommended to enable **Smart Connect** feature on **Wireless > Wireless Settings** to enjoy a seamless connection between dual-band networks. With Smart Connect enabled, the router's 2.4GHz and 5GHz share the same SSID (network name) and password.

- **If the extender is not connected to this router**

1. Connect one or more OneMesh extenders to this router by following the setup instructions in the extenders' manuals.

- **Note:**

To check full list of TP-Link OneMesh extenders or other devices, visit <https://www.tp-link.com/onemesh/compatibility>.

2. Visit <http://tplinkmodem.net>, and log in with your TP-Link ID or the password you set for the router.
3. Go to **Basic > OneMesh** or **Advanced > OneMesh** to check the devices list.

- **Tips:**

It is recommended to enable **Smart Connect** feature on **Wireless > Wireless Settings** to enjoy a seamless connection between dual-band networks. With Smart Connect enabled, the router's 2.4GHz and 5GHz share the same SSID (network name) and password.

## 14.2. Manage Devices in the OneMesh Network

In a OneMesh network, you can manage all mesh devices and clients on your router's web page.

- **To view all mesh devices and clients in the OneMesh network:**

1. Visit <http://tplinkmodem.net>, and log in with your TP-Link ID or the password you set for the router.
2. Go to [Basic > Network Map](#).
3. Click the [Mesh Devices](#), [Wired Clients](#), or [Wireless Clients](#) icon to view the related device or client list.

ID	Name	Model	MAC Address	Status	Location	Modify
1	RE300	RE300	68:FF:7B:C1:F7:D6	Connected	Other	
2	RE300	RE300	D8:0D:17:B2:7B:26	Connected	Living Room	

4. Click [Modify](#) icon to customize the device's name and location.

ID	Name	Model	MAC Address	Status	Location	Modify
1	RE300	RE300	68:FF:7B:C1:F7:D6	Connected	Office	

Name:

MAC Address:

Location:

- **To manage each OneMesh device in the network:**

1. Visit <http://tplinkmodem.net>, and log in with your TP-Link ID or the password you set for the router.
2. Go to [Basic > OneMesh](#) or [Advanced > OneMesh](#).

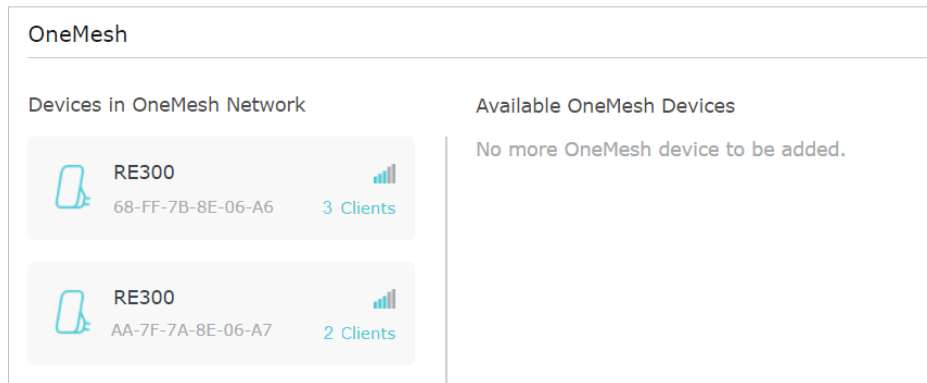

3. Click a OneMesh device to view the device information, or click [<number> Clients](#) to view the clients connected to this device.

On the [Device Info](#) page, you can:

- Click [Manage Device](#) to redirect to the web management page of this OneMesh device.
- Click [Leave OneMesh](#) to delete this device from the OneMesh network.

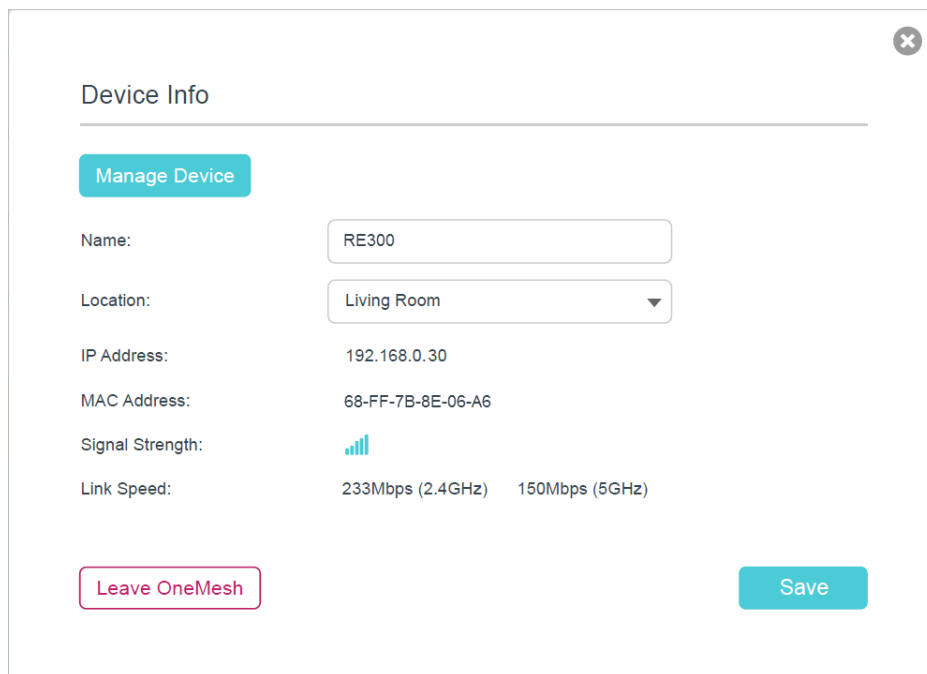

# FAQ

## Q1. How do I restore my router to its factory default settings?

- **Reset the router manually:**

With the router powered on, press and hold the RESET button on the rear panel until the Power LED starts flashing.

- **Reset the router via web management page:**

1. Visit <http://tplinkmodem.net>, and log in with the password or your TP-Link ID.
2. Click [Advanced](#) > [System Tools](#) > [Backup & Restore](#) page.
3. Click [Factory Restore](#) to reset the router.
4. Wait for the resetting and then the router will automatically reboot.

**Note:**

Once the router is reset, the current configuration settings will be lost and you will need to re-configure the router.

## Q2. What should I do if I forget my password?

- **Web management page password:**

Restore the router to its factory default settings and then create a new password using 1-32 characters.

- **Wireless network password:**

1. The default Wireless Password/PIN is printed on the product label of the router.
2. If the default wireless password has been changed, log in to the router's web management page and go to [Basic](#) > [Wireless](#) to retrieve or reset your password.

- **TP-Link ID password:**

Click [Forgot password](#) on the TP-Link ID login page and then follow the instructions to reset it

## Q3. What should I do if I cannot access the web management page?

This can happen for a variety of reasons. Please try the methods below to log in again.

- Make sure your computer has connected to the router correctly and the corresponding LED lights up.
- Make sure the IP address of your computer is configured as [Obtain an IP address automatically](#) and [Obtain DNS server address automatically](#).
- Make sure you enter the correct IP address to log in: <http://tplinkmodem.net>.
- Check your computer's settings:

- 1) Go to **Start > Control Panel > Network and Internet**, and click **View network status and tasks**.
- 2) Click **Internet Options** on the bottom left.
- 3) Click **Connections** and select **Never dial a connection**.

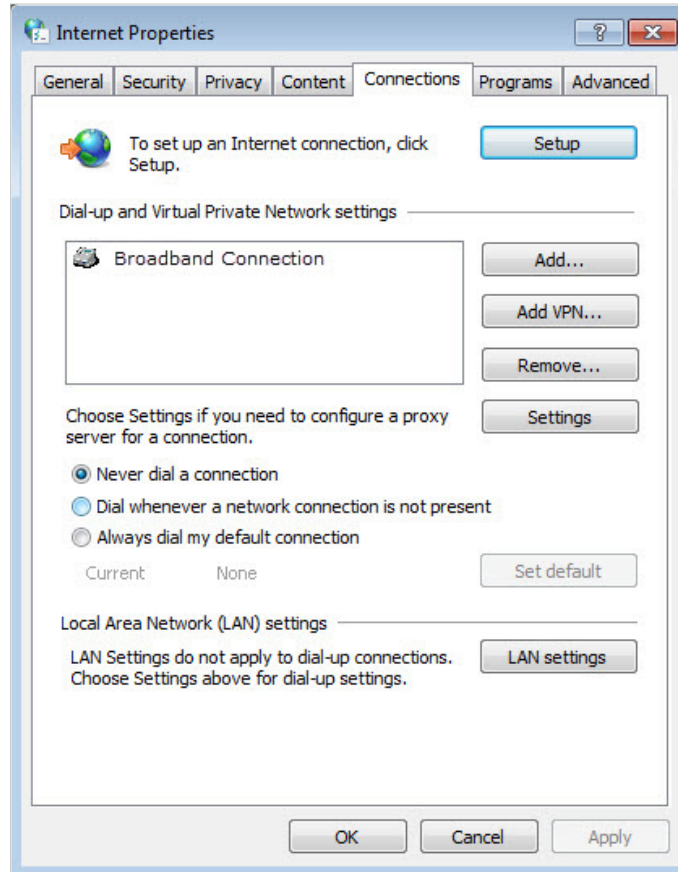

- 4) Click **LAN settings**, deselect the following three options and click **OK**;

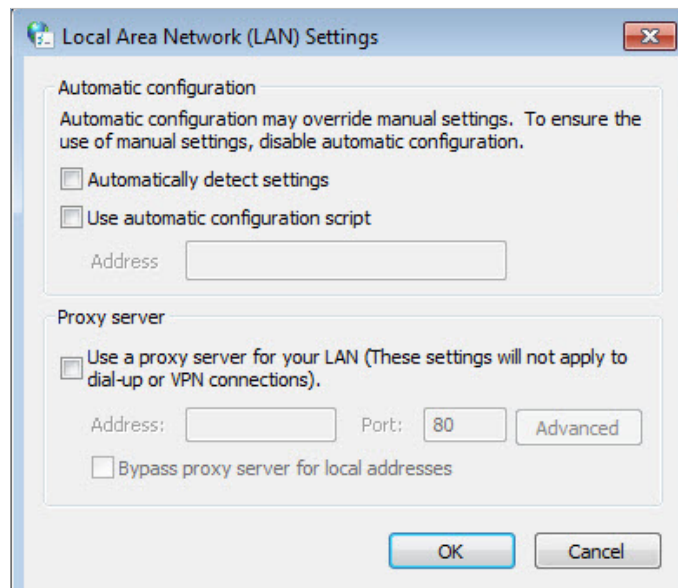

5) Go to **Advanced > Restore advanced settings**, click **OK** to save the settings.

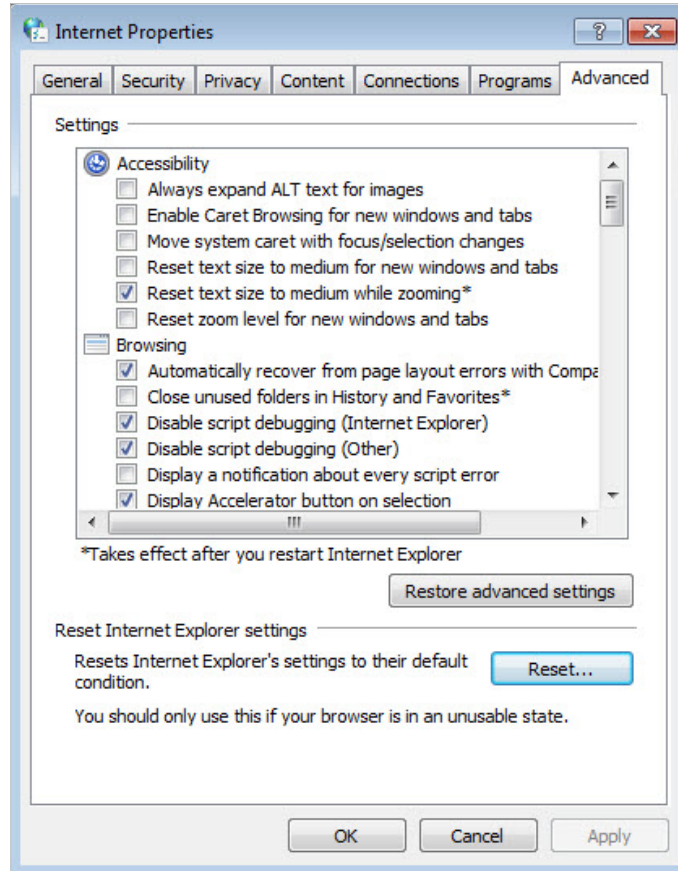

- Use another web browser or computer to log in again.
- Reset the router to factory default settings and try again. If the login still fails, please contact the technical support.

■ **Note:** You'll need to reconfigure the router to surf the internet once the router is reset.

#### Q4. What can I do if I cannot access the internet?

1. Verify that your SIM card is an LTE or WCDMA card.
2. Verify that your SIM card is in your ISP's service area.
3. Verify that your SIM card has sufficient credit.
4. Check the LAN connection:  
Open a web browser and enter <http://tplinkmodem.net> or <http://192.168.1.1> in the address bar. If the login page does not appear, refer to Q3 and then try again.
5. Check your ISP parameters:
  - 1) Open a web browser and log in to the web management page.

- 2) Go to [Advanced](#) > [Network](#) > [Internet](#) to verify the parameters (including the APN, Username and Password) provided by your ISP are correctly entered. If the parameters are incorrect, click [Create Profile](#) and enter the correct parameters, then select the new profile from the Profile Name list.
6. Check the PIN settings:
  - 1) Open a web browser and log in to the web management page.
  - 2) Go to [Advanced](#) > [Network](#) > [PIN Management](#) to verify if PIN is required. If it is, enter the correct PIN provided by your ISP or disable [PIN Lock](#), and click [Save](#).
7. Check the Data Limit:
  - 1) Open a web browser and log in to the web management page.
  - 2) Go to [Advanced](#) > [Network](#) > [Data Settings](#) to verify if the [Total Used](#) exceeds the [Total Allowance](#) or if the [Monthly Used](#) exceeds the [Monthly Allowance](#). If it does, click [Correct](#) and set [Total/Monthly Used](#) to 0 (zero), or disable [Data Limit](#).
8. Check the Mobile Data:
  - 1) Open a web browser and log in to the web management page.
  - 2) Go to [Advanced](#) > [Network](#) > [Internet](#) to verify that [Mobile Data](#) is enabled. If not, toggle it On to access the internet.
9. Check the Data Roaming:
  - 1) Confirm with your ISP if you are in a roaming service area. If you are, open a web browser and log in to the web management page.
  - 2) Go to [Advanced](#) > [Network](#) > [Internet](#) to verify that [Data Roaming](#) is enabled. If not, toggle it On to access the internet.

## Q5. What should I do if my internet speed is slow?

1. Make sure you are inside a network coverage area.
2. Relocate your router and your computer to have a better signal reception – you may be in or near a structure that is blocking the signal. Obstacles (for example, walls, ceilings, and furniture) between the router and other wireless devices decreases the signal strength.
3. The 2.4GHz Wi-Fi network may be interfered. It is recommended to use the 5GHz Wi-Fi network if your devices support it. Visit <http://tplinkmodem.net>, and log in with the password or your TP-Link ID. Go to [Basic](#) > [Wireless](#) page and enable [Wireless Network 5GHz](#). Then you can search the SSID of your 5GHz wireless network on your wireless devices and connect to it.



## Q6. How to use the router as a regular wireless router to share my internet ?

The router support two operation modes, 3G/4G Router Mode and Wireless Router mode. If you already have a modem or your internet comes via an Ethernet cable from the wall, you can set up the router as a regular wireless router to share the internet.

1. Connect your router's LAN4/WAN port to the modem or the network port.
2. Visit <http://tplinkmodem.net>, and log in with password you set for the router.
3. Go to [Advanced](#) > [Operation Mode](#) page.

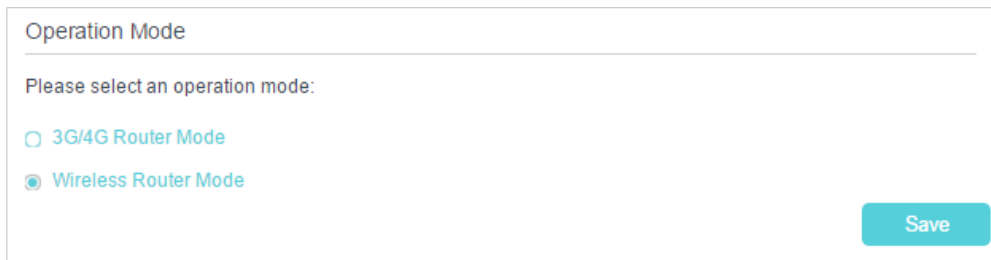

Operation Mode

Please select an operation mode:

3G/4G Router Mode

Wireless Router Mode

Save

4. Select the [Wireless Router Mode](#) option and click [Save](#) to make the settings effective.

### Note:

1. In wireless router mode, you can use 3G/4G network as a backup solution for internet access. When [3G/4G Backup](#) is enabled, your router will be directly connected to the 3G/4G network when your fixed network failure is detected. To enable or disable [3G/4G Backup](#), go to [Advanced](#) > [Network](#) > [Internet](#), and configure [Offline Detection](#).

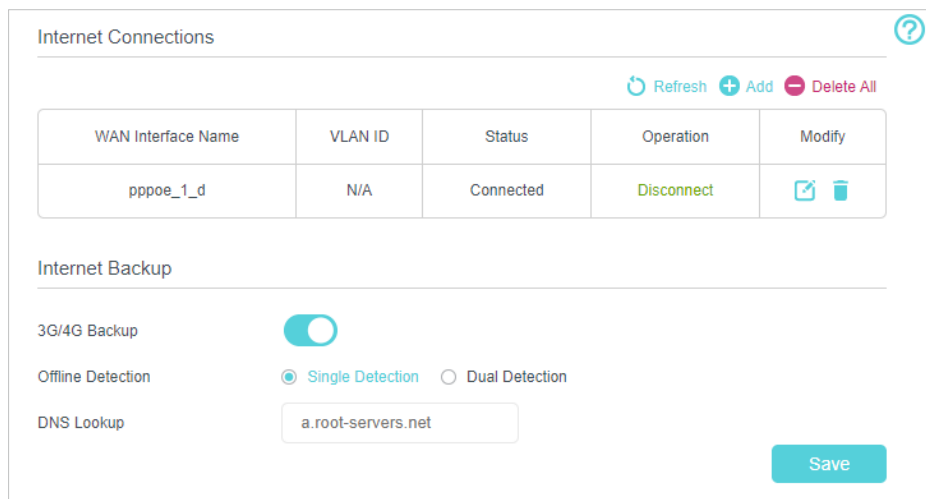

Internet Connections

Refresh + Add - Delete All

WAN Interface Name	VLAN ID	Status	Operation	Modify
pppoe_1_d	N/A	Connected	Disconnect	

Internet Backup

3G/4G Backup

Offline Detection  Single Detection  Dual Detection

DNS Lookup

Save

2. In wireless router mode, you can set up your router for an IPTV connection. To enable and configure [IPTV](#), go to [Advanced](#) > [IPTV](#).

IPTV

IPTV:  Enable

Profile:

VLAN ID:  Enable

Connection Type:

LAN Port:  LAN1  LAN2  LAN3

## Q7. What can I do if I cannot find my wireless network or I cannot connect the wireless network?

- **If you fail to find any wireless network, please follow the steps below:**
  1. Make sure the wireless function is enabled if you're using a laptop with built-in wireless adapter. You can refer to the relevant document or contact the laptop manufacturer.
  2. Make sure the wireless adapter driver is installed successfully and the wireless adapter is enabled.

### On Windows 7

- 1) If you see the message **No connections are available**, it is usually because the wireless function is disabled or blocked somehow;

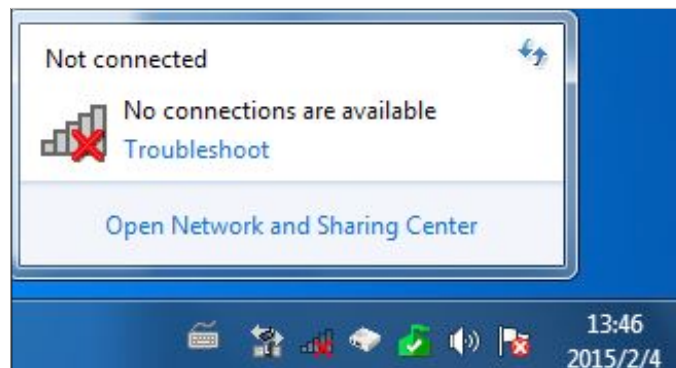

- 2) Clicking on **Troubleshoot** and windows might be able to fix the problem by itself.

### On Windows XP

- 1) If you see the message **Windows cannot configure this wireless connection**, this is usually because windows configuration utility is disabled or you are running another wireless configuration tool to connect the wireless.

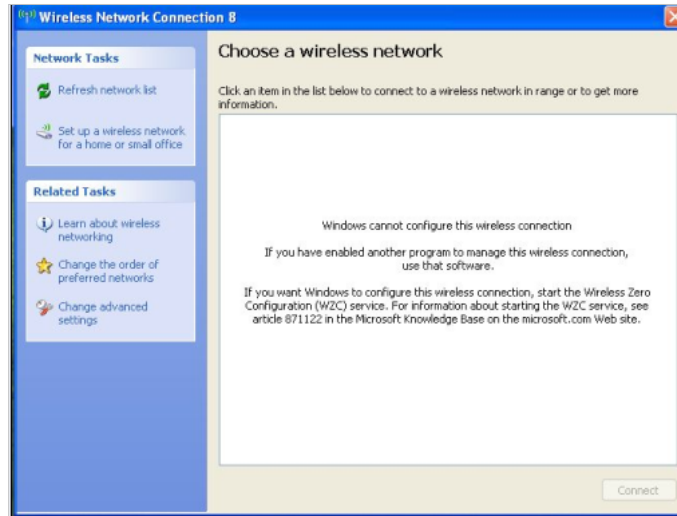

- 2) Exit the wireless configuration tool (the TP-Link Utility, for example);
- 3) Select and right click on **My Computer** on desktop, select **Manage** to open Computer Management window;
- 4) Expand **Services and Applications > Services**, find and locate **Wireless Zero Configuration** in the Services list on the right side;

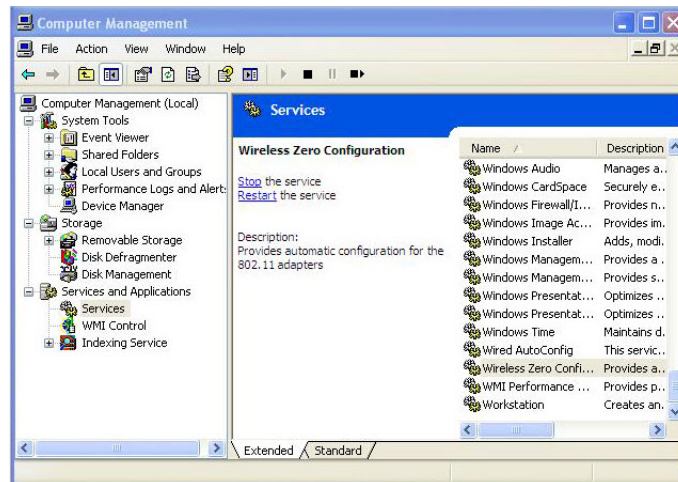

- 5) Select **Wireless Zero Configuration**, right click it, and then select **Properties**;

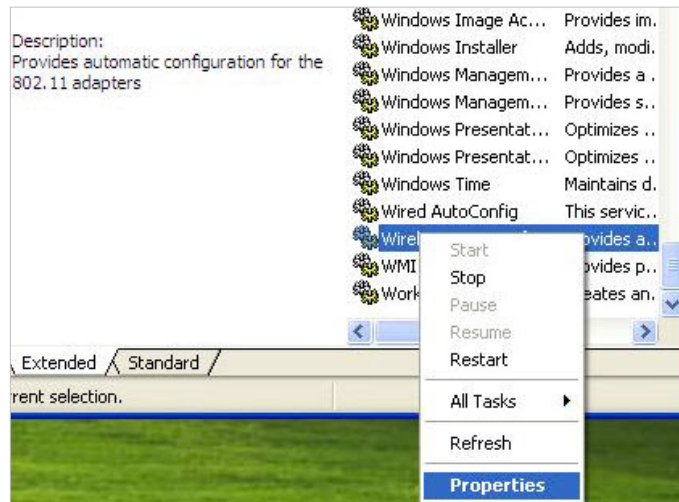

6) Change **Startup type** to **Automatic**, click on **Start** button and make sure the Service status is **Started**. And then click **OK**.



7) Connect to wireless network.

- If you can find other wireless network except your own, please follow the steps below:
  1. Check the WLAN LED indicator on your router;
  2. Make sure your computer/device is still in the range of your router/modem, move closer if it is currently too far away;

3. Go to [Advanced](#) > [Wireless](#) > [Advanced Settings](#) page, and check the wireless router settings. Double check your Wireless Network Name, and make sure the SSID is not hidid;
4. Connect to wireless network.
- If you can find your wireless network but fail to connect, please follow the steps below:
  1. Authenticating problem, password mismatch.
    - 1) Sometimes it will ask you to type in a PIN number when you connect to the wireless network for the first time. This PIN number is different from the Wireless Password/Network Security Key, usually you can only find it on the back of your wireless router/modem;



- 2) If you cannot find the PIN or PIN failed, you may choose [Connecting using a security key instead](#), and then type in the Network Security Key/Wireless Password;



- 3) If it continues saying network security key mismatch, it is suggested to confirm the wireless password on your wireless router/modem;

■ Note: Wireless password/Network Security Key is case-sensitive.



- 4) Connect to wireless network.
2. Windows was unable to connect to XXXX /Cannot join this network/Taking longer than usual to connect to this network.
  - 1) Check the wireless signal strength of your network, if it is weak (1~3 bars), please move the router closer and try again;
  - 2) Change the wireless Channel of the router to 1,6,or 11 to reduce interference from other networks;
  - 3) Re-install or update the driver for your wireless adapter of the computer;
  - 4) Connect to wireless network.

## CE Mark Warning



This is a class B product. In a domestic environment, this product may cause radio interference, in which case the user may be required to take adequate measures.

## OPERATING FREQUENCY(the maximum transmitted power)

2400 MHz -2483.5 MHz (20dBm)

5150 MHz -5250 MHz (23dBm)

WCDMA: B1/B8 (24dBm+1.7/-3.7dB)

LTE: B1/B3/B7/B8/B20/B38/B40 (23dBm±2.7dB)

LTE: B28 (23dBm+2.7/-3.2 dB)

## EU declaration of conformity

TP-Link hereby declares that the device is in compliance with the essential requirements and other relevant provisions of directives 2014/53/EU, 2009/125/EC, 2011/65/EU and (EU)2015/863.

The original EU declaration of conformity may be found at <https://www.tp-link.com/en/ce>

## UK declaration of conformity

TP-Link hereby declares that the device is in compliance with the essential requirements and other relevant provisions of the Radio Equipment Regulations 2017.

The original UK declaration of conformity may be found at <https://www.tp-link.com/support/ukca>





## RF Exposure Information

This device meets the EU requirements (2014/53/EU Article 3.1a) on the limitation of exposure of the general public to electromagnetic fields by way of health protection. The device complies with RF specifications when the device used at 20 cm from your body.

## National restrictions

Attention: This device may only be used indoors in all EU member states, EFTA countries and Northern Ireland.

Attention: This device may only be used indoors in Great Britain.

	AT	BE	BG	CH	CY	CZ	DE	DK
	EE	EL	ES	FI	FR	HR	HU	IE
	IS	IT	LI	LT	LU	LV	MT	NL
	NO	PL	PT	RO	SE	SI	SK	UK(NI)
	UK							

## NCC Notice

注意！

依據 低功率電波輻射性電機管理辦法

LP0002低功率射頻器材技術規範\_章節3.8.2

取得審驗證明之低功率射頻器材，非經核准，公司、商號或使用者均不得擅自變更頻率、加大功率或變更原設計之特性及功能。

低功率射頻器材之使用不得影響飛航安全及干擾合法通信；經發現有干擾現象時，應立即停用，並改善至無干擾時方得繼續使用。

前述合法通信，指依電信管理法規定作業之無線電通信。

低功率射頻器材須忍受合法通信或工業、科學及醫療用電波輻射性電機設備之干擾。

應避免影響附近雷達系統之操作。

高增益指向性天線只得應用於固定式點對點系統。

## BSMI Notice

安全諮詢及注意事項

- 請使用原裝電源供應器或只能按照本產品注明的電源類型使用本產品。
- 清潔本產品之前請先拔掉電源線。請勿使用液體、噴霧清潔劑或濕布進行清潔。
- 注意防潮，請勿將水或其他液體潑灑到本產品上。
- 插槽與開口供通風使用，以確保本產品的操作可靠並防止過熱，請勿堵塞或覆蓋開口。
- 請勿將本產品置放於靠近熱源的地方。除非有正常的通風，否則不可放在密閉位置中。
- 不要私自拆開機殼或自行維修，如產品有故障請與原廠或代理商聯繫。

### 限用物質含有情況標示聲明書

Equipment name 設備名稱：4G+ Cat6 AC1200 Wireless Dual Band Gigabit Router	型號（型式）：Archer MR500 Type designation (Type)
---	--



單元 Unit	限用物質及其化學符號 Restricted substances and its chemical symbols					
	鉛 Lead (Pb)	汞 Mercury (Hg)	鎘 Cadmium (Cd)	六價鉻 Hexavalent chromium (Cr <sup>+6</sup> )	多溴聯苯 Polybrominated biphenyls (PBB)	多溴二苯醚 Polybrominated diphenyl ethers (PBDE)
PCB	○	○	○	○	○	○
外殼	○	○	○	○	○	○
電源供應器	—	○	○	○	○	○
天線	○	○	○	○	○	○
備考 1. “超出 0.1 wt %” 及 “超出 0.01 wt %” 係指限用物質之百分比含量超出百分比含量基準值 Note 1: “Exceeding 0.1 wt %” and “exceeding 0.01 wt %” indicate that the percentage content of the restricted substance exceeds the reference percentage value of presence condition. 備考 2. “○” 係指該項限用物質之百分比含量未超出百分比含量基準值。 Note 2: “○” indicates that the percentage content of the restricted substance does not exceed the percentage of reference value of presence. 備考 3. “—” 係指該項限用物質為排除項目。 Note 3: The “—” indicates that the restricted substance corresponds to the exemption.						



Продукт сертифіковано згідно с правилами системи УкрСЕПРО на відповідність вимогам нормативних документів та вимогам, що передбачені чинними законодавчими актами України.



## Safety Information









- Keep the device away from water, fire, humidity or hot environments.
- Do not attempt to disassemble, repair, or modify the device. If you need service, please contact us.
- Do not use damaged charger or USB cable to charge the device.
- Do not use any other chargers than those recommended.
- Do not use the device where wireless devices are not allowed.
- Adapter shall be installed near the equipment and shall be easily accessible.
- Use only power supplies which are provided by manufacturer and in the original packing of this product. If you have any questions, please don't hesitate to contact us.

Please read and follow the above safety information when operating the device. We cannot guarantee that no accidents or damage will occur due to improper use of the device. Please use this product with care and operate at your own risk.

## Environment

- Operating Temperature: 0°C~40°C (32°F ~104°F)
- Operating Humidity: 10%~90% non-condensing
- Storage Humidity: 5%~90% non-condensing

## Explanation of the symbols on the product label

Symbol	Explanation
	Class II equipment
	DC voltage
	Indoor use only
	Polarity of output terminals
	Energy efficiency Marking
	Caution
	Operator's manual
	<p><b>RECYCLING</b></p> <p>This product bears the selective sorting symbol for Waste electrical and electronic equipment (WEEE). This means that this product must be handled pursuant to European directive 2012/19/EU in order to be recycled or dismantled to minimize its impact on the environment.</p> <p>User has the choice to give his product to a competent recycling organization or to the retailer when he buys a new electrical or electronic equipment.</p>