

Tilted Diamond⁺ signal lamp, 24 Volt, bezel yellow, Cage Clamp[®]



fields of application

- › Measurement-control-regulation
- › Electrical engineering
- › Mechanical and system engineering
- › Signalling systems
- › Vehicle construction
- › Industrial robots
- › Model construction

special features

- › Special refracted light effect due to diamond lens
- › Diffuser lens designed by cult designer Luigi Colani
- › Long-lasting and ultra-bright SMT LEDs
- › Energy efficient: low electricity consumption
- › Low-maintenance: particularly shock-resistant, no bulb replacement necessary
- › Terminal with M12 plug or direct wiring with CAGE CLAMP[®]
- › Accessory program: extension support tubes in different lengths
- › Available colors: red, yellow, green, blue, transparent/white



description

RAFI has further refined the Tilted Diamond signal lamp, developed in collaboration with Luigi Colani. The result: Tilted Diamond⁺, which is also very easy to assemble, thanks to the M12 or CAGE CLAMP[®] terminal.

To achieve outstanding illumination, we have optimized the light refraction. Its uniform, all-round high visibility makes the signal lamp even easier to see from a distance, so you can respond even faster in an emergency. In line with everyday requirements in industrial environments, this signal lamp is especially sustainable and shock-resistant. In addition, the bright LEDs are energy efficient and do not have to be replaced. The resulting overall package, for many fields of application, will exceed your expectations.

The wiring of the terminals must be carried out by trained specialist personnel.

technical data

› general

Color	black
Bezel color	yellow
Property of bezel / mushroom	translucent
Bezel shape	convex
Collar shape	round
Operating temperature, min.	-30 °C
Operating temperature, max.	60 °C
Storage temperature, min.	-40 °C
Storage temperature, max.	85 °C
illuminated	Yes

direct links

- › [RAFI eCatalog](#)

Luminous elements	LED
Packaging	Box
Packaging unit	1 pcs.
net weight	52.9 g
Degree of protection, front side, according to DIN EN 60529	IP66 IP67
shock resistance	08 side 08 frontal
MOQ order	10 pcs.
RoHS compliant	Yes
REACH compliant	Yes
> mounting diameters	
Outside dimension, length	56.8 mm
Outside dimension, width	56.8 mm
Outside dimension, height	70.1 mm
Installation height	70.1 mm
Collar dimension	56.8 mm
> mechanical data	
Fixing	Screw
Terminal on the rear	Cage Clamp®
Abisolierlänge	10 mm
> electrical data	
Operating voltage of the luminous element, min.	20 V
Operating voltage of the luminous element, max.	28 V
Voltage type	DC
Rated operating voltage	20-28 V
Power loss	2.24 W
Maximum connection cross section	0.75 mm ²
Minimum connection cross section	0.2 mm ²

drawings

Dimensioned drawing

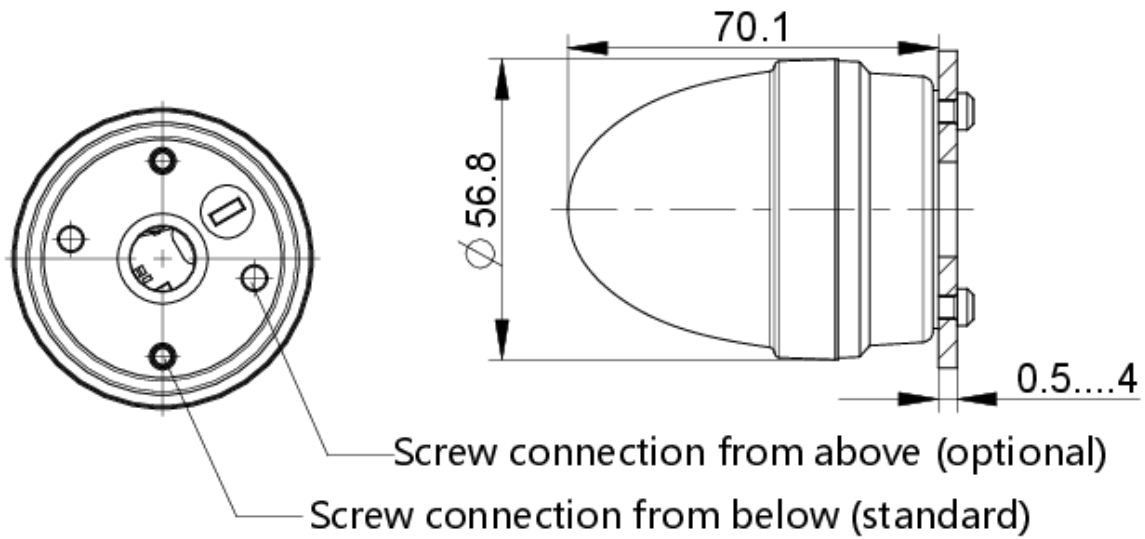

Schematic diagram

