

# TILTED DIAMOND<sup>+</sup>3 signal lamp, lamp red / yellow / green, 24 Volt, bezel transparent, M12 4-pin A-coded



## fields of application

- > Measurement-control-regulation
- > Electrical engineering
- > Mechanical and system engineering
- > Signalling systems
- > Vehicle construction
- > Industrial robots
- > Model construction



## description

**RAFI** has further refined the Tilted Diamond signal lamp, developed in collaboration with Luigi Colani. The result: Tilted Diamond<sup>+</sup>, which is also very easy to assemble, thanks to the M12 or CAGE CLAMP<sup>®</sup> terminal.

To achieve outstanding illumination, we have optimized the light refraction. Its uniform, all-round high visibility makes the signal lamp even easier to see from a distance, so you can respond even faster in an emergency. In line with everyday requirements in industrial environments, this signal lamp is especially sustainable and shock-resistant. In addition, the bright LEDs are energy efficient and do not have to be replaced. The resulting overall package, for many fields of application, will exceed your expectations.

## technical data

### > general

Color	black
Bezel color	transparent
Property of bezel / mushroom	transparent
Luminous element color	red / yellow / green
Bezel shape	convex
Collar shape	round
Operating temperature, min.	-30 °C
Operating temperature, max.	60 °C
Storage temperature, min.	-40 °C
Storage temperature, max.	85 °C
illuminated	Yes
Luminous elements	LED
Packaging	Box
Packaging unit	1 pcs.
net weight	62.2 g
Degree of protection, front side, according to DIN EN 60529	IP66 IP67

### direct links

- > [RAFI eCatalog](#)

Degree of protection, rear side, according to DIN EN 60529	IP65
shock resistance	08 side 08 frontal
MOQ order	10 pcs.
RoHS compliant	Yes
REACH compliant	Yes
<b>&gt; mounting diameters</b>	
Outside dimension, length	56.8 mm
Outside dimension, width	56.8 mm
Outside dimension, height	84.6 mm
Mounting depth	14.5 mm
Installation height	70.1 mm
Collar dimension	56.8 mm
<b>&gt; mechanical data</b>	
Fixing	Screw
Terminal on the rear	M12 4-pin A-coded
PIN 1	LED red
PIN 2	LED green
PIN 3	GND
PIN 4	LED yellow
<b>&gt; electrical data</b>	
Operating voltage of the luminous element, min.	20 V
Operating voltage of the luminous element, max.	28 V
Voltage type	DC
Rated operating voltage	20-28 V
Power loss	2.187 W

**drawings**

**Dimensioned drawing**

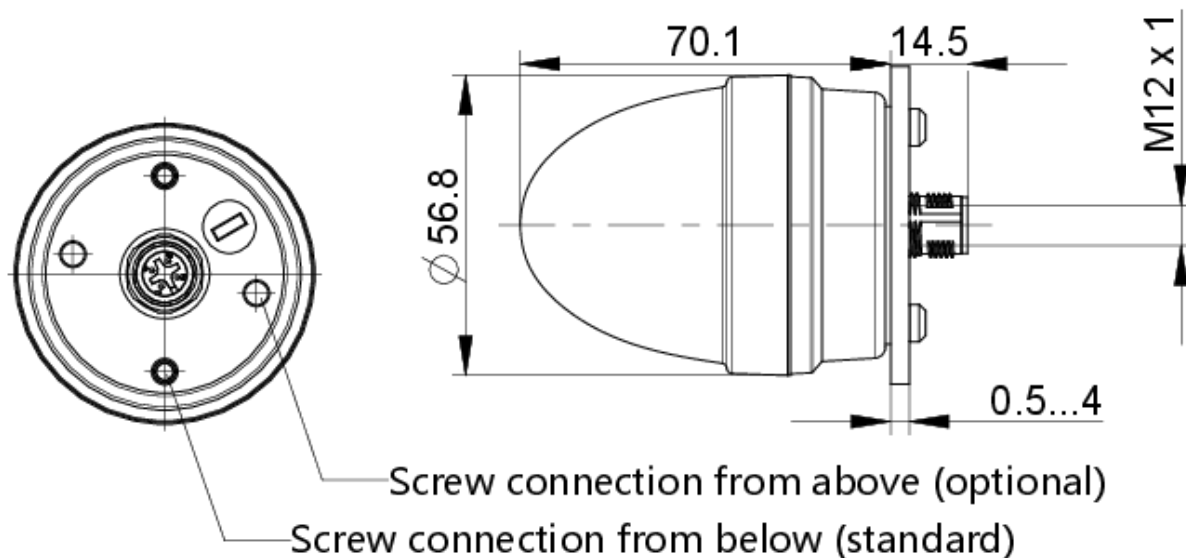

**System drawing**

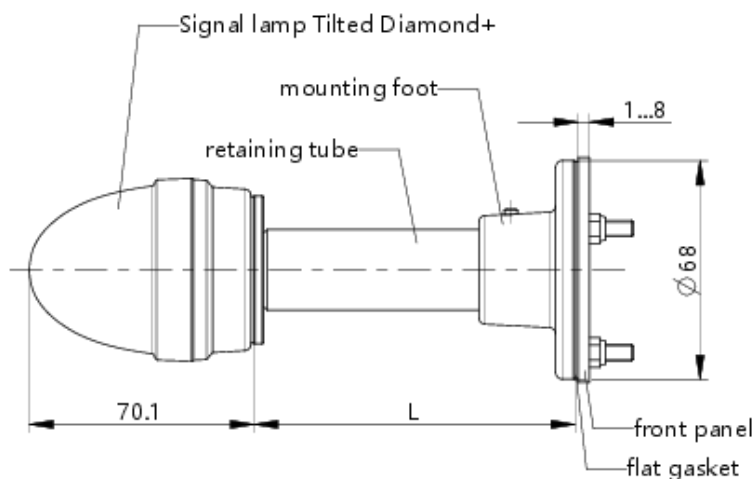

**Mounting hole drawing**

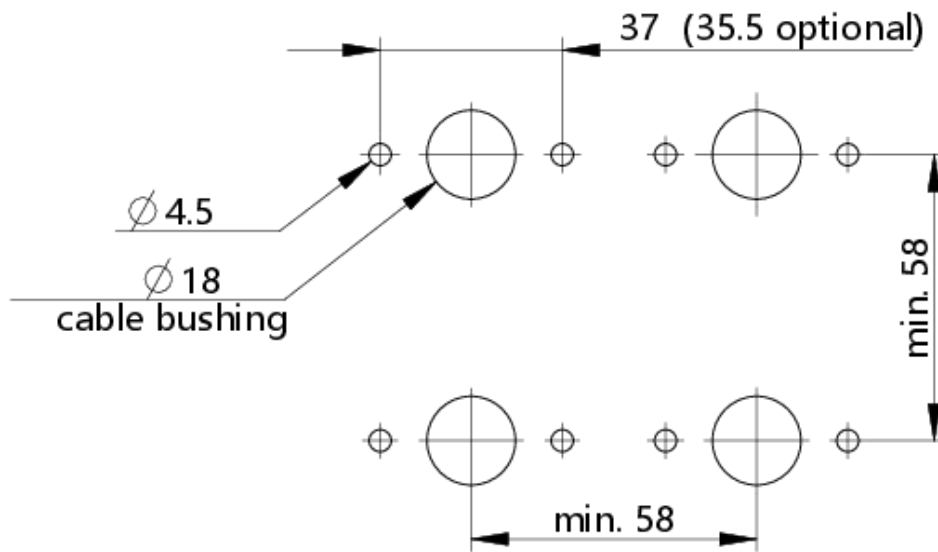

**Schematic diagram**

