

## RAMO 22 T, M12, round collar, momentary contact function, frontring metallic silver, 1 NO, bezel red



### fields of application

- › Measurement-control-regulation
- › Electrical engineering
- › Mechanical and system engineering
- › Vehicle construction
- › Chemical industry
- › Industrial robots

### special features

- › Key stroke with tactile feedback or mushroom pushbutton with latching actuator
- › Based on the RAFI MICON 5 short-travel keyswitch with gold contacts, which has proven itself millions of times over
- › Single-part, closed housing
- › Unique series with easiest Plug&Play connection
- › Completely tailored design – fits the RAFIX range of control components
- › Installation size: 22.3 mm
- › Plug & Play connection M12
- › Custom print options, including FLEXLAB bezels
- › Can be illuminated in many colors
- › Redundant version with 2 NO contacts
- › Pushbutton with black mushroom head



### description

Because it features the RAFI MICON 5 tactile switch, RAMO 22 T offers tactile feedback with a noticeable click. Due to the IP 66/ IP69K degree of protection, it is recommended in particular for plant engineering and construction. RAMO 22 T requires a mounting hole diameter of 22.3 mm.

As a further product variant, the RAMO 22 T mushroom pushbutton offers a latching pushbutton option for every application. It is characterised by form and function as for an emergency stop, but is only declared as a pushbutton. Various contact functions are possible.

### Additional information according to UL certificate:

- › Only approved for Class 2 Power Source or Limited Voltage / Limited Current.
- › Installation only by trained specialist personnel.
- › Type 4x Indoor only with cable "Cat. No. 7000-08061-0210100 PUR 4x0.25mm<sup>2</sup> with M8 connector, rated max. 30VAC/DC 4A, manufactured by Murrelektronik GmbH" and "Cat. No. 7000-12221-0340100 PUR 4x0.34mm<sup>2</sup> with M12 connector, rated max. 30VAC/DC 4A, manufactured by Murrelektronik GmbH"
- › For Use on a Flat Surface of a Type 1 or 4x indoor only Enclosure.

## technical data

### > general

Potential free	yes
Color	black
Bezel color	red
Property of bezel / mushroom	translucent
Collar color	black
Front ring color	metallic silver
Luminous element color	white
Collar shape	round
Operating temperature, min.	-40 °C
Operating temperature, max.	85 °C
Storage temperature, min.	-40 °C
Storage temperature, max.	85 °C
illuminated	Yes
Luminous elements	LED
Packaging	Box
Packaging unit	10 pcs.
net weight	12.6 g
Operating life	500,000 cycles
B10	650,000 cycles
Degree of protection, front side, according to DIN EN 60529	IP66 IP67 IP69
Degree of protection, rear side, according to DIN EN 60529	IP66 IP67
UL Enclosure Type Rating front side	type 4X indoor
Environment resistance	IEC 60068-2-14 IEC 60068-2-30 IEC 60068-2-33 IEC 60068-2-78
Salt-spray resistance according to standard	IEC 60068-2-11
shock resistance	05
MOQ order	10 pcs.
Pollution degree acc. to DIN EN 61010-1	Pollution degree 2
RoHS compliant	Yes
REACH compliant	Yes

### > mounting diameters

Outside dimension, length	40 mm
Outside dimension, width	29.8 mm
Outside dimension, height	29.8 mm
Mounting hole	22.3 mm
Mounting depth	30.2 mm
Installation height	9.8 mm

### direct links

> [RAFI eCatalog](#)

Grid, min.	30 mm
<b>&gt; mechanical data</b>	
Actuation function	momentary contact function
Operating force, max.	12 N
Operating force, min.	5 N
Operating travel, max.	1 mm
Resistance to force on the side	300 N
Contact function	1 NO
Contact material	Gold
Fixing	Threaded ring
Threaded ring torque, max.	1.2 Nm
Terminal on the rear	M12 4-pin A-coded
PIN 1	Normally open contact 1
PIN 2	LED +
PIN 3	GND
PIN 4	Normally open contact 1
<b>&gt; electrical data</b>	
Rated insulation voltage	250 V
Rated surge voltage	800 V
Rated operating voltage	35 V (AC-15) 35 V (DC-13)
Operating voltage of the luminous element, min.	20 V
Operating voltage of the luminous element, max.	28 V
Rated voltage, min.	0.02 V
Rated voltage, max.	35 V
Rated voltage, max. acc. to UL 60947	30 V DC (42,4 V peak)
Voltage type	DC
Rated operating current	0.1 A
Rated operating voltage	0.02-35 V
Rated current, min.	0.00001 A
Rated current, max.	0.1 A
Rated power, max.	1 W
Power loss	0.7 W
Overvoltage category	2
Kind of short circuit protective device	fuse 250 V / 0,1 A / 1,5 kA gG quick
Conditional short circuit current	1,000 A

**drawings**

**Dimensioned drawing**

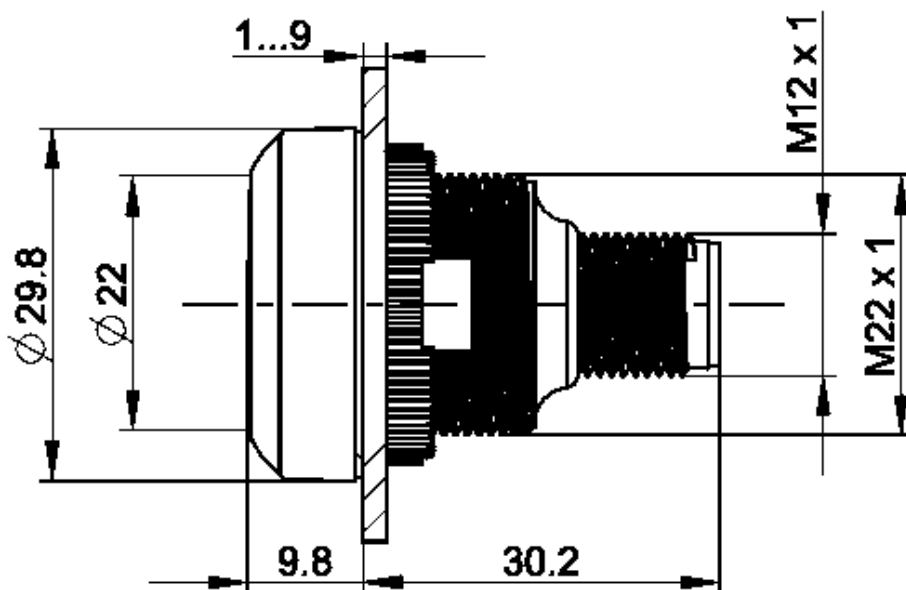

**Mounting hole drawing**

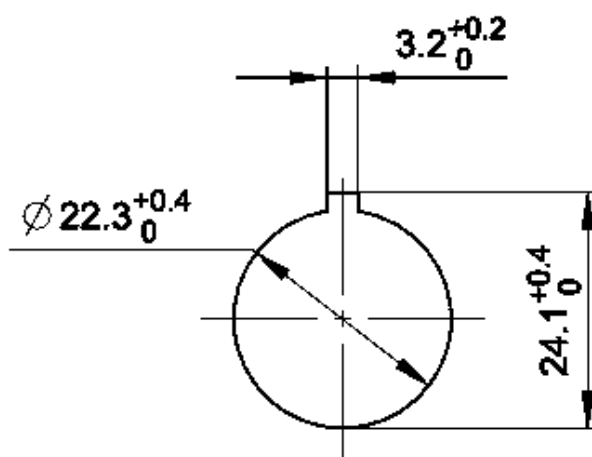

acc. to IEC 60947-5-1

**Schematic diagram**

