

E-BOX M12, 1 illuminated pushbutton FLEXLAB, frontring metallic silver, 1 NO



fields of application

- › Measurement-control-regulation
- › Mechanical and system engineering
- › Construction machinery
- › Industrial robots
- › Model construction
- › Home technology

special features

- › Compact dimensions: 109 x 40 x 27 mm
- › Various actuator-indicator combinations from the RAFIX 22 FS+ control unit series
- › With yellow upper part of housing for combinations with emergency stop actuator
- › With gray upper part of housing for pushbutton combinations
- › Mounting with time-saving single-hole screw mounting technology, particularly suitable for aluminum profile rails or alternatively direct mounting with M4 screws
- › Connection with M12 plug: "Plug and Play"



description

The E-Box M12 is a ready-to-connect, completely equipped housing including actuator and switching elements. Thus, for example, emergency stop, on/off and up/down functions, also with additional status displays, can be implemented with the very compact dimensions of the E-Box. The assembly: Screw on the clip, put on the box, connect the plug, check and ready. The E-Box M12 can be used wherever individual command device units are required at decentralized locations. Typically, for example, for emergency stop applications along a production facility or at the safety fence. The dimensions of the E-Box M12 are based on the edge dimensions of a 40 mm profile rail and the mounting concept is also designed for this.

technical data

› general

Actuator position 1	FLEXLAB illuminated pushbutton
Color	light gray
Collar color	dark gray
Front ring color	metallic silver
Luminous element color	white
Collar shape	round
Operating temperature, min.	-25 °C
Operating temperature, max.	70 °C
Storage temperature, min.	-40 °C
Storage temperature, max.	80 °C
illuminated	Yes
Luminous elements	LED
Packaging	Box

direct links

- › [RAFI eCatalog](#)

Packaging unit	1 pcs.
net weight	96.9 g
Operating life electrical	1.000.000 (10mA / 24V DC) cycles
B10 electrical	1.300.000 (10mA / 24V DC) cycles
Degree of protection, front side, according to DIN EN 60529	IP65
Degree of protection, rear side, according to DIN EN 60529	IP65
Protection class	II
MOQ order	1 pcs.
RoHS compliant	Yes
REACH compliant	Yes
> mounting diameters	
Outside dimension, length	123.2 mm
Outside dimension, width	40 mm
Outside dimension, height	35.6 mm
> mechanical data	
Contact function	1 NO
Contact material	Gold
Fixing	Assembly clip
Terminal on the rear	M12 4-pin A-coded
PIN 1	LED +
PIN 2	GND
PIN 3	Normally open contact 1
PIN 4	Normally open contact 1
> electrical data	
Operating voltage of the luminous element, max.	24 V
Rated voltage, min.	5 V
Rated voltage, max.	35 V
Voltage type	AC / DC
Rated operating voltage	5-35 V
Rated current, min.	0.001 A
Rated current, max.	0.1 A
Rated power, max.	0.25 W
Power loss	0.15 W

drawings

Dimensioned drawing

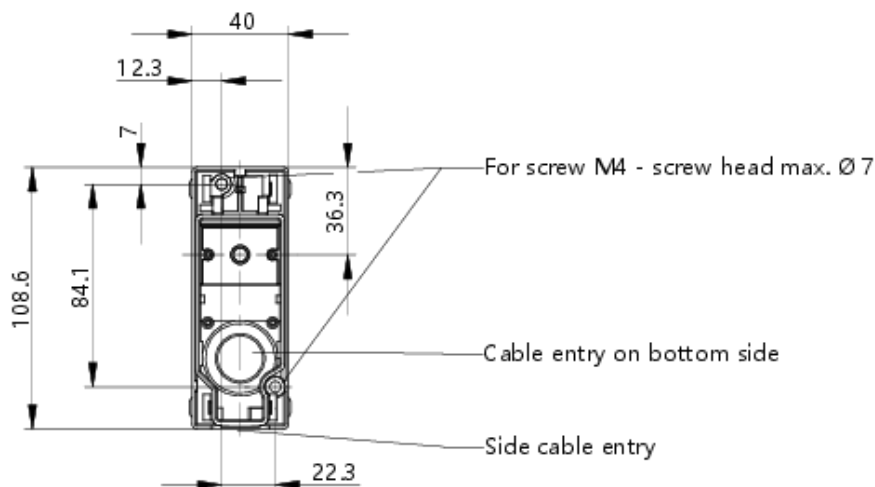

System drawing

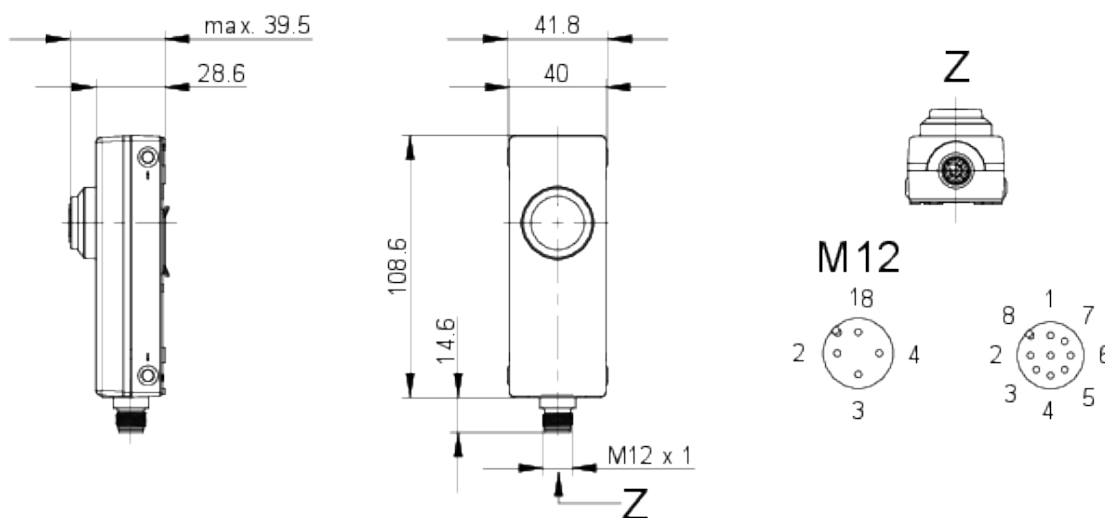

Schematic diagram

