

RAFIX 16, buzzer, round collar, 70 dB



fields of application

- Measurement-control-regulation
- Electrical engineering
- Mechanical and system engineering
- Industrial robots

special features

- Acoustic signal transmitter in three fret forms
- 70 dB continuous tone
- Degree of protection: IP 65 at the front
- Mounting diameter 16.2 mm
- Flat plug connection 2.8 x 0.8 mm



description

Acoustic signal generator, available in three collar shapes to match the design of the RAFIX 16 actuators.

technical data

➤ general

Bezel color	black
Property of bezel / mushroom	opaque
Collar shape	round
Frequency	2,400 - 3100 Hz
Operating temperature, min.	-25 °C
Operating temperature, max.	70 °C
Storage temperature, min.	-40 °C
Storage temperature, max.	85 °C
Volume 1 m	70 dB
illuminated	No
Tone type	Continuous tone
Packaging	Box
Packaging unit	2 pcs.
net weight	8.5 g
Degree of protection, front side, according to DIN EN 60529	IP65
Environment resistance	IEC 60068-2-14 IEC 60068-2-30 IEC 60068-2-33 IEC 60068-2-78
MOQ order	10 pcs.
RoHS compliant	Yes
REACH compliant	Yes

➤ mounting diameters

Outside dimension, length	24.95 mm
---------------------------	----------

direct links

- [RAFI eCatalog](#)

Outside dimension, width	24.95 mm
Outside dimension, height	37.45 mm
Mounting hole	16.2 mm
Mounting depth	30.5 mm
Installation height	6.95 mm
Grid, min.	25 x 25 mm
Collar dimension	ø 24,95 mm
> mechanical data	
Fixing	Threaded ring
Threaded ring torque, max.	1.2 Nm
Terminal on the rear	Flat quick-connect terminal 2.8 x 0.8
> electrical data	
Voltage type	DC
Rated operating voltage	24 V
Power loss	0.6 W

drawings

Dimensioned drawing

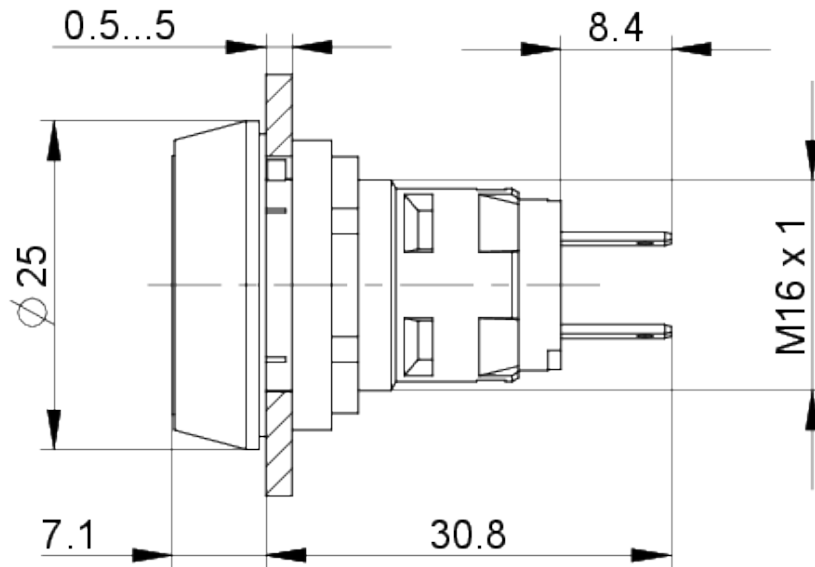

Mounting hole drawing

