

# MICON 5, square plunger 14.5 mm, mechanical stop limit, green, GH 9.55 mm



## fields of application

- > Measurement-control-regulation
- > Mechanical and system engineering
- > Automotive
- > Signalling systems
- > Vehicle construction
- > Handheld terminals

## description

The wide selection of standard plungers in different shapes and colors guarantees a versatile range of applications for the MICON 5 tactile switch.

## technical data

### > general

Bezel color	green
illuminated	Yes
Packaging unit	100 pcs.
net weight	0.9 g
MOQ order	500 pcs.
RoHS compliant	Yes
REACH compliant	Yes

### direct links

- > [RAFI eCatalog](#)

### > mounting diameters

Outside dimension, length	8.7 mm
Outside dimension, width	14.5 mm
Outside dimension, height	14.5 mm
Plunger length L	6.2 mm
Support height A	3.35 mm
Total height GH	9.55 mm

**drawings**

**Dimensioned drawing**

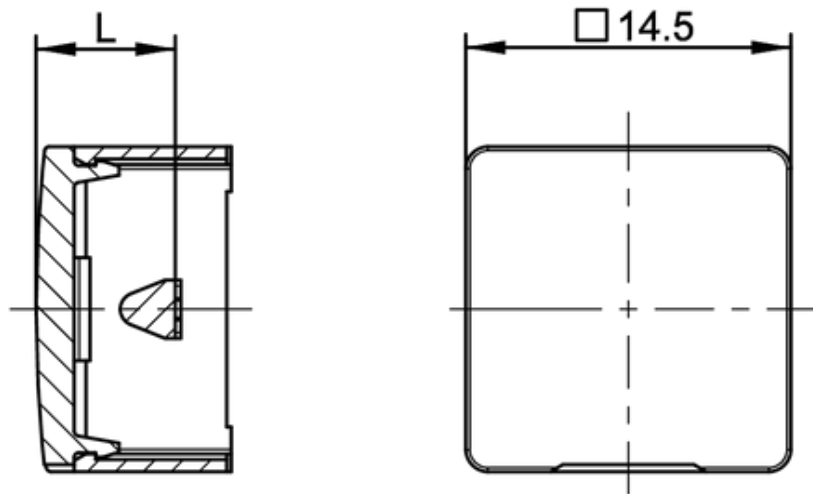

**System drawing**

Structure:  
High embossing 0.35 mm  
Adhesive thickness 0.15 mm

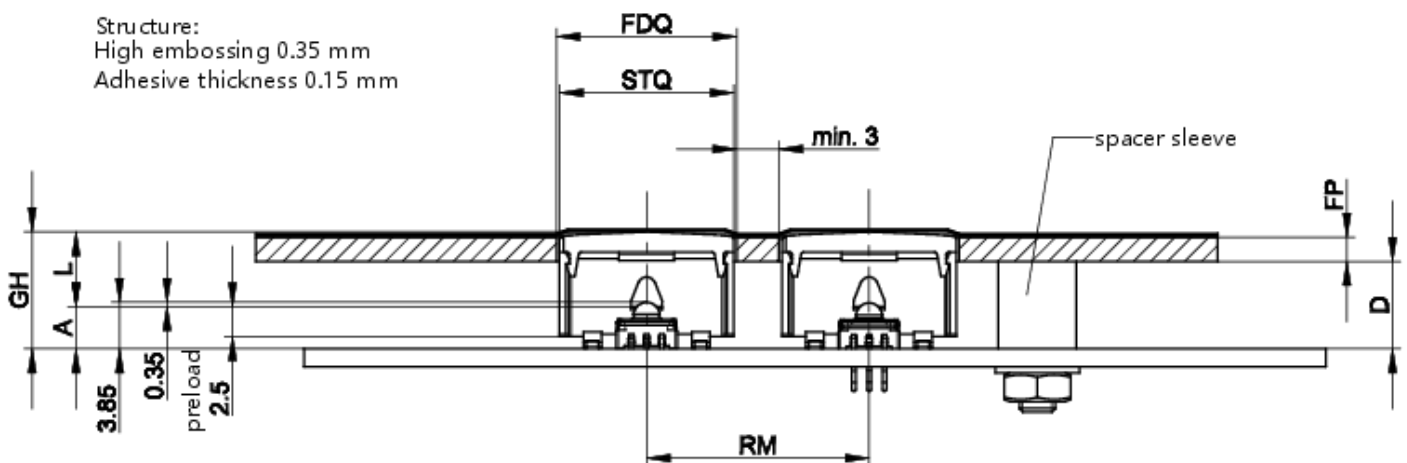

$GH=A+L$

PCB drawing

View without front panel,  
foil and screen

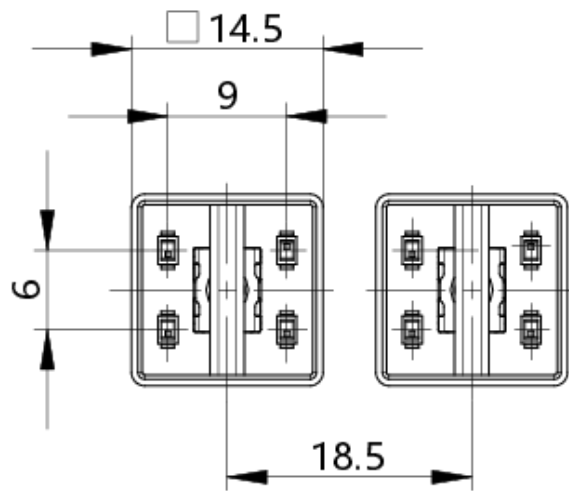

Illustration with 4 LED OSRAM LO M676-Q1R1-24

PCB drawing

View without front panel,  
foil and screen

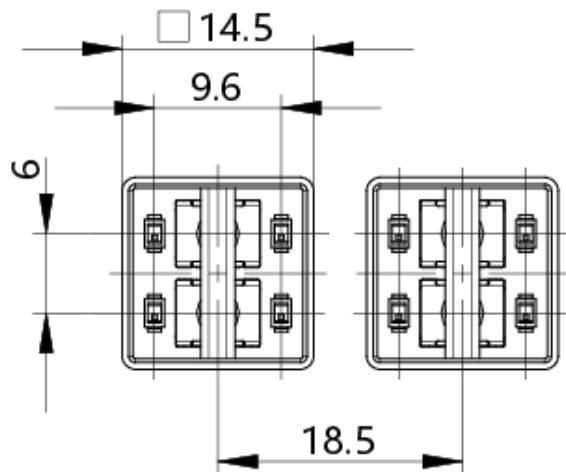

Illustration with 4 LED OSRAM LO M676-Q1R1-24