

RACON, round plunger 14.5 mm, L 2.9 mm



fields of application

- > Measurement-control-regulation
- > Mechanical and system engineering
- > Automotive
- > Signalling systems
- > Vehicle construction
- > Handheld terminals

description

The wide selection of standard plungers in different shapes and colors guarantees a versatile range of applications for the RACON tactile switch.

technical data

> general

Color	white
Collar shape	round
illuminated	No
Packaging unit	500 pcs.
net weight	0.2 g
MOQ order	2,500 pcs.
RoHS compliant	Yes
REACH compliant	Yes
Component material	Plastic

direct links

- > [RAFI eCatalog](#)

> mounting diameters

Outside dimension, length	4.4 mm
Outside dimension, width	14.5 mm
Outside dimension, height	14.5 mm
Plunger length L	2.9 mm

drawings

Dimensioned drawing

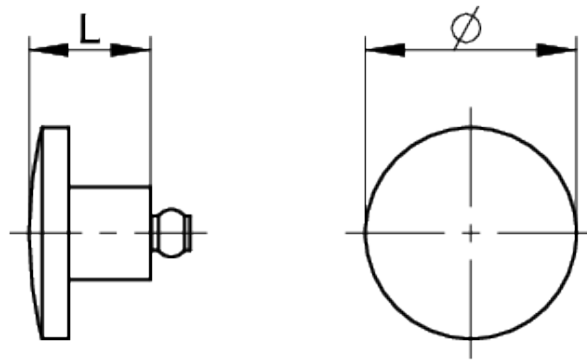

System drawing

SMT gullwing connection

Recommended: Embossing: 0.35 mm

Adhesive thickness: 0.15 mm

