



KERN & Sohn GmbH

Ziegelei 1
72336 Balingen-Frommern
Germany

www.kern-sohn.com

+0049-[0]7433-9933-0

+0049-[0]7433-9933-149

info@kern-sohn.com

Operating instructions Precision Balance

KERN EWJ

Type TEWJ-B

Version 1.0

2023-09

GB

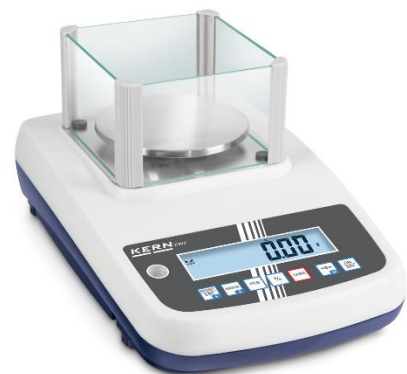

TEWJ-B-BA-e-2310



KERN EWJ

Version 1.0 2023-09

Operating instructions Precision balance

Content

1	Technical data	5
2	Declaration of conformity	9
3	Appliance overview	10
3.1	Components	10
3.2	Operating elements	11
3.2.1	Keyboard overview.....	11
3.2.2	Numerical input	12
3.2.3	Overview of displays	13
4	Basic Information (General)	14
4.1	Proper use	14
4.2	Improper Use.....	14
4.3	Warranty.....	14
4.4	Monitoring of Test Resources.....	15
5	Basic Safety Precautions	15
5.1	Pay attention to the instructions in the Operation Manual	15
5.1	Personnel training.....	15
6	Transport and storage	15
6.1	Testing upon acceptance	15
6.1	Packaging / return transport	15
7	Unpacking, Installation and Commissioning	16
7.1	Installation Site, Location of Use	16
7.2	Unpacking and checking	17
7.3	Assembling, Installation and Levelling.....	17
7.4	Mains connection.....	17
7.5	Rechargeable battery operation (Factory option)	18
7.5.1	Load rechargeable battery	18
7.6	Connection of peripheral devices	19
7.7	Initial Commissioning.....	19
7.8	Adjustment	19
7.8.1	Internal adjustment < CAL INT >.....	20

7.8.2	External adjustment < cALeHt >	21
7.8.3	External adjustment with user-defined adjustment weight < cALeUd >.....	22
7.8.4	Gravitational constant adjustment location < GrAAdu >	24
7.8.5	Gravitational constant place of location < GrAubE >	25
8	Verification	26
9	Basic Operation	28
9.1	Turn on/off	28
9.2	Simple weighing	28
9.3	Zeroing	29
9.4	Taring	29
9.5	Switch-over weighing unit.....	30
10	Operating concept	32
11	Application <Weighing>	34
11.1	Application-specific settings	34
11.2	PRE-Tare	36
11.2.1	Take over the placed weight as PRE-TARE value.....	36
11.2.2	Enter the known tare weight numerically	37
11.3	Data-Hold function	38
11.4	Weighing Units	38
11.4.1	Setting weighing unit	38
11.4.2	Weighing with multiplication factor via the application unit <FFA>.....	39
11.4.3	Percent weighing by application unit <%>	40
11.4.4	Molar weighing mode	41
12	Application <Counting>	42
12.1	Application-specific settings	42
12.2	Using the application.....	43
12.2.1	Piece counting.....	43
12.2.2	Target counting	46
13	Application < Checkweighing >	49
13.1	Application-specific settings	49
13.2	Using the application.....	50
13.2.1	Target weighing.....	50
13.2.2	Checkweighing.....	53
14	Menü	55
14.1	Navigation in the menu.....	55
14.2	Application menu.....	55
14.3	Setup menu.....	56

14.3.1	Overview < ኃይዲሆ >	56
15	Interfaces.....	64
15.1	RS-232C interface.....	64
15.1.1	Technical data.....	64
15.1.2	Interface cable.....	64
15.1.3	Connect printer.....	65
15.2	USB connection	65
15.2.1	Connect PC.....	65
15.3	Bluetooth (Factory option)	66
15.3.1	Add device	66
15.3.2	Determine COM Port number.....	68
15.4	KERN Communications Protocol (KERN Interface Protocol)	69
15.5	Issue functions	70
15.5.1	Add-up mode < ኃህብ >.....	70
15.5.2	Data output after pressing the PRINT button < ቦላሰላ >.....	72
15.5.3	Automatic data output < ለህጽ >	73
15.5.4	Continuous data output < ርዕኔ >.....	73
15.6	Data format	74
16	Servicing, maintenance, disposal	75
16.1	Cleaning	75
16.2	Servicing, maintenance	75
16.3	Disposal	75
17	Instant help for troubleshooting.....	76
18	Error messages.....	77

1 Technical data

KERN	EWJ 600-3	EWJ 6000-2
Item no./ Type	TEWJ 600-3-A	TEWJ 6000-2-A
Readability (d)	0,001 g	0,01 g
Weighing range (max)	600 g	6000 g
Reproducibility	0,003 g	0,03 g
Linearity	± 0,005 g	± 0,05 g
Stabilization time (typical)	6 s	
Smallest part weight for piece counting - under lab conditions*	2 mg	10 mg
Smallest part weight for piece counting - under normal conditions**	20 mg	100 mg
Recommended adjustment weight, not added (class)	600 g (E2)	6 kg (E2)
Warm-up time	4 h	
Weighing Units	g, kg, gn, dwt, tl (Tw), tl (HK), ozt, tl (Singap, Malays), ct, mo, lb, oz, ffa, m	
Humidity of air	80 %	
Allowable ambient temperature	15 °C ... 30 °C	
Input voltage Appliance	12 V DC, 500 mA	
Input voltage Mains adapter	100 V – 240 V, 50 / 60 Hz	
Storage battery operation (optional)	Operating time 57 hrs (backlight off) Operating time 32 hrs (backlight on) Loading time approx. 6,5 hrs.	
Auto-Off (rechargeable battery)	selectable off, 30s, 1, 2, 5, 30, 60 min	
Dimensions housing	220 x 340 x 321 mm	220 x 340 x 105 mm
Weighing plate, stainless steel	Ø 120 mm	155 x 145 mm
Net weight (kg)	3,2	3,4
Interfaces	RS232, Bluetooth 2.0 (factory option), Bluetooth 4.0 (factory option), USB-D	

KERN	EWJ 300-3	EWJ 300-3H	EWJ 3000-2
Item no./ Type	TEWJ 300-3-B	TEWJ 300-3H-B	TEWJ 3000-2-B
Readability (d)	0,001 g	0,001 g	0,01 g
Weighing range (max)	300 g	300 g	3000 g
Reproducibility	0,003 g	0,003 g	0,03 g
Linearity	± 0,005 g	± 0,005 g	± 0,05 g
Stabilization time (typical)	2 s		
Smallest part weight for piece counting - under lab conditions*	2 mg	2 mg	20 mg
Smallest part weight for piece counting - under normal conditions**	20 mg	20 mg	200 mg
Recommended adjustment weight, not added (class)	300 g (F1)	300 g (F1)	3 kg (F1)
Warm-up time	2 h		
Weighing Units	g, kg, gn, dwt, tl (Tw), tl (HK), ozt, tl (Singap, Malays), ct, mo, lb, oz, ffa, m		
Humidity of air	80 %		
Allowable ambient temperature	15 °C ... 30 °C		
Input voltage Appliance	12 V DC, 500 mA		
Input voltage Mains adapter	100 V – 240 V, 50 / 60 Hz		
Storage battery operation (optional)	Operating time 57 hrs (backlight off) Operating time 32 hrs (backlight on) Loading time approx. 6,5 hrs.		
Auto-Off (rechargeable battery)	selectable off, 30s, 1, 2, 5, 30, 60 min		
Dimensions housing	220 x 340 x 90 mm	220 x 340 x 321	220 x 340 x 105
Weighing plate, stainless steel	Ø 80 mm	Ø 80 mm	Ø 135 mm
Net weight (kg)	2,6	3,6	3,0
Interfaces	RS232, Bluetooth 2.0 (factory option), Bluetooth 4.0 (factory option), USB-D		

KERN	EWJ 600-2M	EWJ 600-2SM
Item no./ Type	TEWJ 600-2M-B	TEWJ 600-2SM-B
Readability (d)	0,01 g	0,01 g
Weighing range (max)	600 g	600 g
Reproducibility	0,01 g	0,01 g
Linearity	± 0,03 g	± 0,03 g
Stabilization time (typical)	2 s	
Verification value (e)	0,1 g	0,1 g
Verification class	II	II
Minimum weight (min)	0,5 g	0,5 g
Smallest part weight for piece counting - under lab conditions*	20 mg	20 mg
Smallest part weight for piece counting - under normal conditions**	200 mg	200 mg
Recommended adjustment weight, not added (class)	internal	internal
Warm-up time	2 h	
Weighing Units	g, kg, ct	
Humidity of air	80 %	
Allowable ambient temperature	15 °C ... 30 °C	
Input voltage Appliance	12 V DC, 500 mA	
Input voltage Mains adapter	100 V – 240 V, 50 / 60 Hz	
Storage battery operation (optional)	Operating time 57 hrs (backlight off) Operating time 32 hrs (backlight on) Loading time approx. 6,5 hrs.	
Auto-Off (rechargeable battery)	selectable off, 30s, 1, 2, 5, 30, 60 min	
Dimensions housing	220 x 340 x 90 mm	220 x 340 x 90
Weighing plate, stainless steel	Ø 120 mm	Ø 120 mm
Net weight (kg)	3,2	2,8
Interfaces	RS232, Bluetooth 2.0 (factory option), Bluetooth 4.0 (factory option), USB-D	-

KERN	EWJ 6000-1M	EWJ 6000-1SM
Item no./ Type	TEWJ 6000-1M-B	TEWJ 6000-1SM-B
Readability (d)	0,1 g	0,1 g
Weighing range (max)	6000 g	6000 g
Reproducibility	0,1 g	0,1 g
Linearity	± 0,3	± 0,3
Stabilization time (typical)	2 s	
Verification value (e)	1 g	1 g
Verification class	II	II
Minimum weight (min)	5 g	5 g
Smallest part weight for piece counting - under lab conditions*	100 mg	100 mg
Smallest part weight for piece counting - under normal conditions**	1 g	1 g
Recommended adjustment weight, not added (class)	internal	internal
Warm-up time	2 h	
Weighing Units	g, kg, ct	
Humidity of air	80 %	
Allowable ambient temperature	15 °C ... 30 °C	
Input voltage Appliance	12 V DC, 500 mA	
Input voltage Mains adapter	100 V – 240 V, 50 / 60 Hz	
Storage battery operation (optional)	Operating time 57 hrs (backlight off) Operating time 32 hrs (backlight on) Loading time approx. 6,5 hrs.	
Auto-Off (rechargeable battery)	selectable off, 30s, 1, 2, 5, 30, 60 min	
Dimensions housing	220 x 340 x 105	220 x 340 x 105
Weighing plate, stainless steel	155 x 145	155 x 145
Net weight (kg)	3,4	3,4
Interfaces	RS232, Bluetooth 2.0 (factory option), Bluetooth 4.0 (factory option), USB-D	-

*** Smallest part weight for piece counting - under lab conditions:**

- There are ideal ambient conditions for high-resolution counting
- The parts to be counted are not scattered

**** Smallest part weight for piece counting - under normal conditions:**

- There are unsteady ambient conditions (draft, vibrations)
- The parts to be counted are being scattered

2 Declaration of conformity

The current EC/EU Conformity declaration can be found online in:

www.kern-sohn.com/ce

3 Appliance overview

3.1 Components

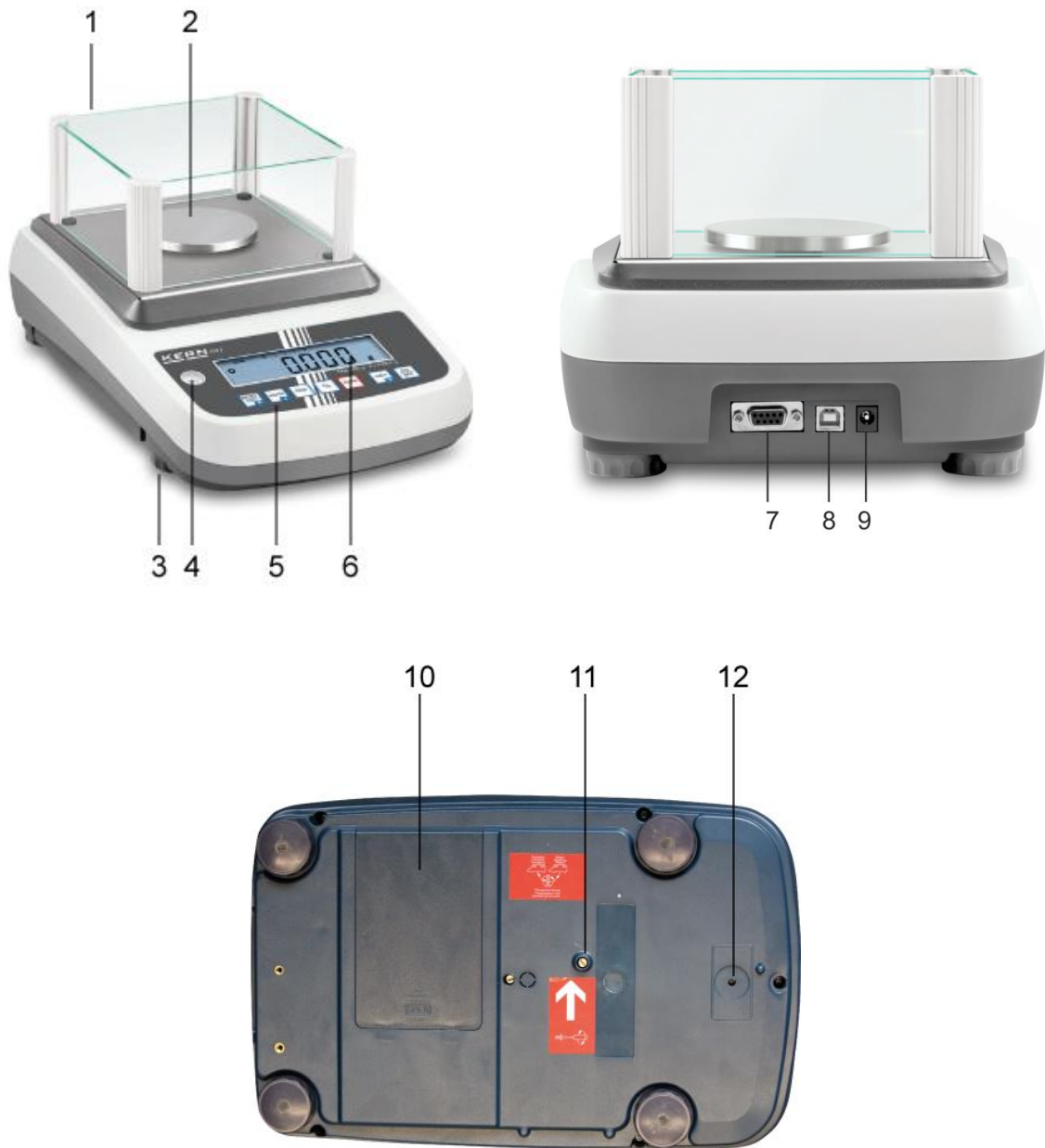

Pos.	Designation	Pos.	Designation
1	Windshield	7	RS232 connection
2	Weighing plate	8	USB connection
3	Levelling screw	9	Mains adapter connection
4	Bubble level	10	Battery case
5	Keyboard	11	Transport lock
6	Display	12	Adjustment switch



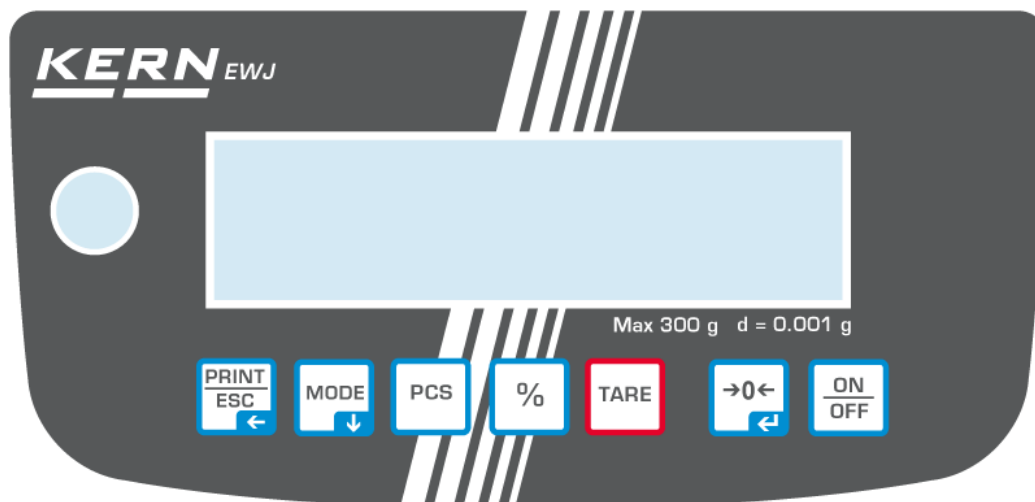

3.2 Operating elements



3.2.1 Keyboard overview

Button	Name	Function in Operating mode	Function in Menu
	PRINT/ESC	<ul style="list-style-type: none"> ➤ Calculate weighing data via interface 	<ul style="list-style-type: none"> ➤ Exit menu / back to weighing mode ➤ Menu level back
	MODE	<ul style="list-style-type: none"> ➤ Switch weighing unit 	<ul style="list-style-type: none"> ➤ Navigation key ↓
	PCS	<ul style="list-style-type: none"> ➤ Counting, see chap. 12 	<ul style="list-style-type: none"> ➤ Navigation key ←
	%	<ul style="list-style-type: none"> ➤ Percent weighing, see chap. 11.4.3 ➤ Internal adjustment (press button long time) 	<ul style="list-style-type: none"> ➤ Navigation key →
	TARE	<ul style="list-style-type: none"> ➤ Taring 	<ul style="list-style-type: none"> ➤ Navigation key ↑
	ZERO	<ul style="list-style-type: none"> ➤ Zeroing 	<ul style="list-style-type: none"> ➤ Select menu item ➤ Confirm selection
	ON/OFF	<ul style="list-style-type: none"> ➤ Switch on/off (press button long time) ➤ Switch on/off the display background illumination (press button short time) 	

3.2.2 Numerical input

Button	Designation	Function
	Navigation key ←	Select cipher
		Confirm entry. Press button repeatedly for every digit. Wait until the numeric input window extinguishes.
	Navigation key →	Select cipher
		Confirm entry. Press button repeatedly for every digit. Wait until the numeric input window extinguishes.
	Navigation key ↓	Reduce flashing cipher (0 – 9)
	Navigation key ↑	Increase flashing cipher (0 – 9)

3.2.3 Overview of displays

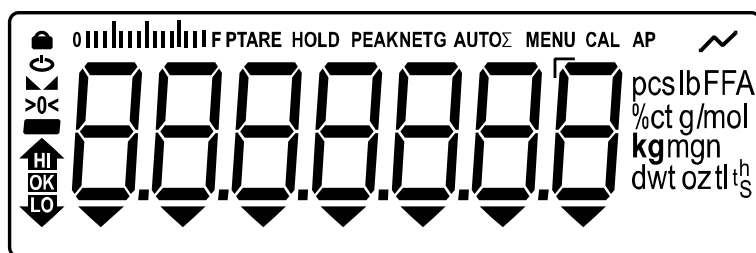

Anzeige	Beschreibung
	Stability display
	Zero display
	Minus display
	Tolerance marks for check weighing
	Bar graph display Indicates how much the weighing plate is loaded with respect to the maximum weighing range
PTARE	PRE-Tare enabled
HOLD	Data-Hold enabled
NET	Display net weight value
G	Display gross weight value
Σ	Weighing data can be found in the sum memory
AP	Autoprint enabled
Units display / Pcs/ %	options g, kg, lb, gn, dwt, oz, ozt or Application icon [Pcs] for piece counting or [%] for determination of percentage

4 Basic Information (General)

4.1 Proper use

The balance you purchased is intended to determine the weighing value of material to be weighed. It is intended to be used as a “non-automatic balance”, i.e. the material to be weighed is manually and carefully placed in the centre of the weighing plate. As soon as a stable weighing value is reached, the weighing value can be read.

4.2 Improper Use

- Our balances are non-automatic balances and not provided for use in dynamic weighing processes. However, the balances can also be used for dynamic weighing processes after verifying their individual operative range, and here especially the accuracy requirements of the application.
- Do not leave permanent load on the weighing plate. This may damage the measuring system.
- Impacts and overloading exceeding the stated maximum load (max) of the balance, minus a possibly existing tare load, must be strictly avoided. Balance may be damaged by this.
- Never operate the balance in explosive environment. The serial version is not explosion protected.
- The structure of the balance may not be modified. This may lead to incorrect weighing results, safety-related faults and destruction of the balance.
- The balance may only be used according to the described conditions. Other areas of use must be released by KERN in writing.

4.3 Warranty

Warranty claims shall be voided in case:

- Our conditions in the operation manual are ignored
- The appliance is used beyond the described uses
- The appliance is modified or opened
- Mechanical damage or damage by media, liquids, natural wear and tear
- The appliance is improperly set up or incorrectly electrically connected
- The measuring system is overloaded

4.4 Monitoring of Test Resources

In the framework of quality assurance the measuring-related properties of the balance and, if applicable, the testing weight, must be checked regularly. The responsible user must define a suitable interval as well as type and scope of this test. Information is available on KERN's home page (www.kern-sohn.com) with regard to the monitoring of balance test substances and the test weights required for this. In KERN's accredited calibration laboratory test weights and balances may be calibrated (return to the national standard) fast and at moderate cost.

5 Basic Safety Precautions

5.1 Pay attention to the instructions in the Operation Manual



⇒ Carefully read this operation manual before setup and commissioning, even if you are already familiar with KERN balances.

5.1 Personnel training

The appliance may only be operated and maintained by trained staff.

6 Transport and storage

6.1 Testing upon acceptance

When receiving the appliance, please check packaging immediately, and the appliance itself when unpacking for possible visible damage.

6.1 Packaging / return transport



- ⇒ Keep all parts of the original packaging for a possibly required return.
- ⇒ Only use original packaging for returning.
- ⇒ Prior to dispatch disconnect all cables and remove loose/mobile parts.
- ⇒ Reattach possibly supplied transport securing devices.
- ⇒ Secure all parts such as the wind screen, the weighing plate, power supply unit etc. against shifting and damage.

7 Unpacking, Installation and Commissioning

7.1 Installation Site, Location of Use

The balances are designed in a way that reliable weighing results are achieved in common conditions of use.

You will work accurately and fast, if you select the right location for your balance.

On the installation site observe the following:

- Place the balance on a firm, level surface.
- Avoid extreme heat as well as temperature fluctuation caused by installing next to a radiator or in the direct sunlight.
- Protect the balance against direct draughts due to open windows and doors.
- Avoid jarring during weighing.
- Protect the balance against high humidity, vapours and dust.
- Do not expose the device to extreme dampness for longer periods of time. Non-permitted condensation (condensation of air humidity on the appliance) may occur if a cold appliance is taken to a considerably warmer environment. In this case, acclimatize the disconnected appliance for ca. 2 hours at room temperature.
- Avoid static charge of goods to be weighed or weighing container.
- Do not operate in areas with hazard of explosive material or in potentially explosive atmospheres due to materials such as gasses, steams, mists or dusts.
- Keep away chemicals (such as liquids or gasses), which could attack and damage the balance inside or from outside.
- In the event of the occurrence of electromagnetic fields, static charges (e.g., when weighing / counting plastic parts) and unstable power supply, large display deviations (incorrect weighing results, as well as damage to the scale) are possible. Change location or remove source of interference.

7.2 Unpacking and checking

Remove device and accessories from packaging, remove packaging material and install the device at the planned workplace. Check if that there has been no damage and that all items of delivery scope are present.

Scope of delivery / serial accessories:

- Balance
- Mains adapter
- Operating instructions
- Protective hood

7.3 Assembling, Installation and Levelling

- ⇒ Remove the transportation lock.
- ⇒ Install weighing plate and wind shield if necessary.
- ⇒ Ensure that the balance is installed in a level position.
- ⇒ Level balance with foot screws until the air bubble of the water balance is in the prescribed circle.

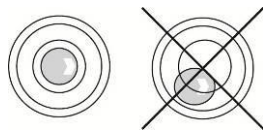

- ⇒ Check levelling regularly

7.4 Mains connection



Select a country-specific power plug and insert it in the mains adapter.



Check, whether the voltage acceptance on the scales is set correctly. Do not connect the scales to the power mains unless the information on the scales (sticker) matches the local mains voltage.



Only use KERN original mains adapter. Using other makes requires consent by KERN.



Important:

- Before starting your weighing balance, check the mains cable for damage.
- Ensure that the power unit does not come into contact with liquids.
- Ensure access to mains plug at all times.

7.5 Rechargeable battery operation (Factory option)

ATTENTION	<ul style="list-style-type: none">⇒ The rechargeable battery and the battery match with each other. Only use the delivered mains adapter.⇒ Do not use the balance during the loading process.⇒ The rechargeable battery can only be replaced by the same or by a type recommended by the manufacturer.⇒ The rechargeable battery is not protected against all environmental influences. If the rechargeable battery is exposed to certain environmental influences, it may set on fire or explode. Persons may be injured or material damage may occur.
	<ul style="list-style-type: none">⇒ Protect the rechargeable battery against fire and heat.⇒ Do not bring the rechargeable battery in contact with fluids, chemical substances or salt.⇒ Do not expose the rechargeable battery to high pressure or microwaves.
	<ul style="list-style-type: none">⇒ Under no circumstances the rechargeable batteries and the charging unit may be modified or manipulated.⇒ Do not use a defective, damaged or deformed rechargeable battery.⇒ Do not connect or short-circuit the electrical contacts of the rechargeable battery with metallic objects.⇒ Liquid may squirt out from a damaged rechargeable battery. If the liquid gets into contact with the skin or the eyes, the skin and the eyes may be irritated.⇒ Ensure the correct polarity when inserting or changing the rechargeable battery (see instructions in the battery compartment)⇒ The rechargeable battery operation is overridden when the mains adapter is connected. For weighing in mains operation > 48 hrs. the rechargeable batteries must be removed! (Danger of overheating).⇒ If the rechargeable battery starts to smell, being hot, changing the colour or being deformed, it must be immediately unplugged from mains supply and from the balance if possible.
	

7.5.1 Load rechargeable battery

The rechargeable battery pack (Option) is charged using the mains cable supplied

Before the first use, the rechargeable battery package should be charged by connecting it to the mains power cable for at least 15 hours.

To save the rechargeable battery, in menu (see chap. 14.3.1) the automatic switch-off function <AutoFF> can be activated.

If the capacity of the rechargeable batteries is exhausted, <Lo Bat> appears in the display. Connect the power cable as soon as possible to load the rechargeable battery. Charging time until complete recharging is approx. 6,5 hrs.

7.6 Connection of peripheral devices

Before connecting or disconnecting of additional devices (printer, PC) to the data interface, always disconnect the balance from the power supply.

With your balance, only use accessories and peripheral devices by KERN, as they are ideally tuned to your balance.

7.7 Initial Commissioning

In order to obtain exact results with the electronic balances, your balance must have reached the operating temperature (see warming up time chap. 1). During this warming up time the balance must be connected to the power supply (mains, rechargeable accumulator or battery).

The accuracy of the balance depends on the local acceleration of gravity.





Strictly observe hints in chapter Adjustment.

7.8 Adjustment

As the acceleration value due to gravity is not the same at every location on earth, each balance must be coordinated - in compliance with the underlying physical weighing principle - to the existing acceleration due to gravity at its place of location (only if the balance has not already been adjusted to the location in the factory). This adjustment process must be carried out for the first commissioning, after each change of location as well as in case of fluctuating environment temperature. To receive accurate measuring values it is also recommended to adjust the balance periodically in weighing operation.

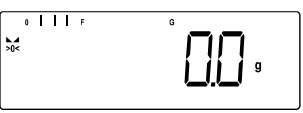
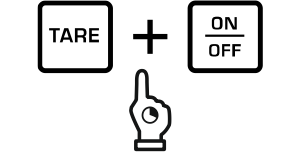
- i** • Carry out adjustment as near as possible to the balance's maximum weight (recommended adjustment weight see chap. 1). Weights of different nominal values or tolerance classes may be used for adjustment but are not optimal for technical measuring. The accuracy of the adjustment weight must correspond approximately to or, if possible, be better than, the readability [**d**] of the balance. Info about test weights can be found on the Internet at: <http://www.kern-sohn.com>
- Observe stable environmental conditions. A warm up time (see chapter 1) is required for stabilization.
- Ensure that there are no objects on the weighing plate.
- Avoid vibration and air flow.
- Always carry out adjustment with the standard weighing plate in place.

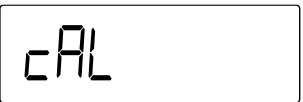
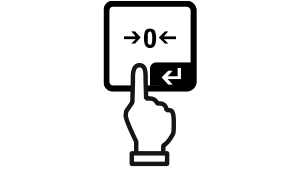
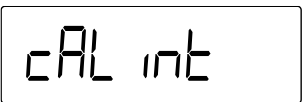
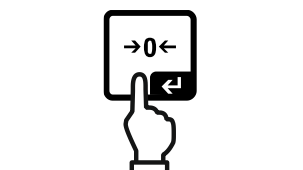
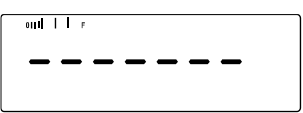
7.8.1 Internal adjustment < cAL int >

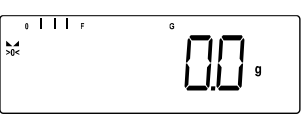
	<p>⇒ Press and hold the TARE and ON/OFF buttons simultaneously to enter the setup menu.</p>
	
	
	<p>⇒ Wait until the first menu item < cAL > is displayed.</p>
	<p>⇒ Confirm by [→] button, < cAL int > will be displayed.</p>
	
	<p>⇒ Confirm by pressing the [→] button</p>
	<p>⇒ Internal adjustment is being carried out (progress is visible via the bar graph display)</p>
	
	<p>⇒ After successful adjustment the balance automatically returns to weighing mode. In case of an adjustment error (e.g. objects on the weighing plate) the display will show the error message < H r o n G >. Switch off balance and repeat the adjustment process.</p>

i The %-button (press button long time, then confirm with the [→] button) in the operating mode can also be used to perform the internal adjustment.

7.8.2 External adjustment < cALEHt >

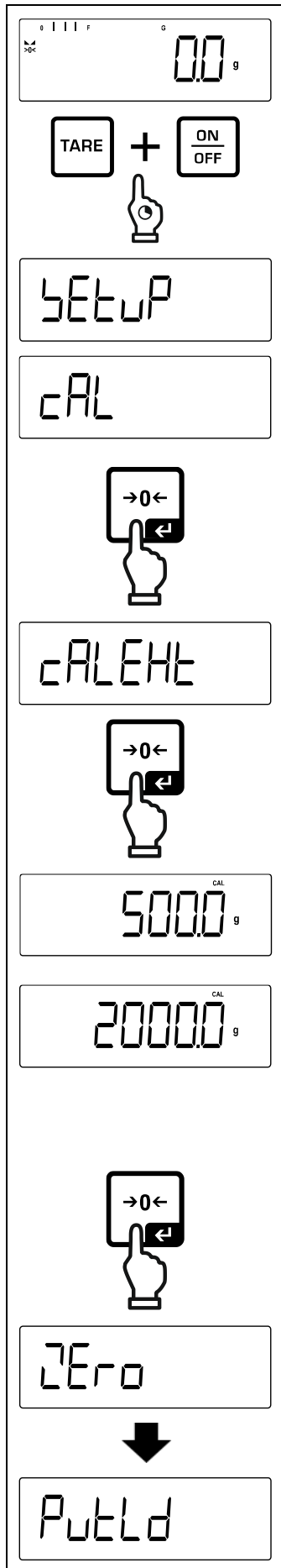

⇒ Press and hold the TARE and ON/OFF buttons simultaneously to enter the setup menu.

⇒ Wait until the first menu item < cAL > is displayed.

⇒ Confirm by [←] button, < cALEHt > will be displayed.

⇒ Confirm by pressing the [←] button, the first selectable adjustment weight is displayed.

⇒ Use the navigation keys ↓↑ to select the desired adjustment weight, see chap. 1 „Recommended adjustment weight“

⇒ Prepare the required adjustment weight.

⇒ Acknowledge selection by [←] button. < Zero >, < PutLd > followed by the weight value of the adjustment weight to be placed will be displayed.

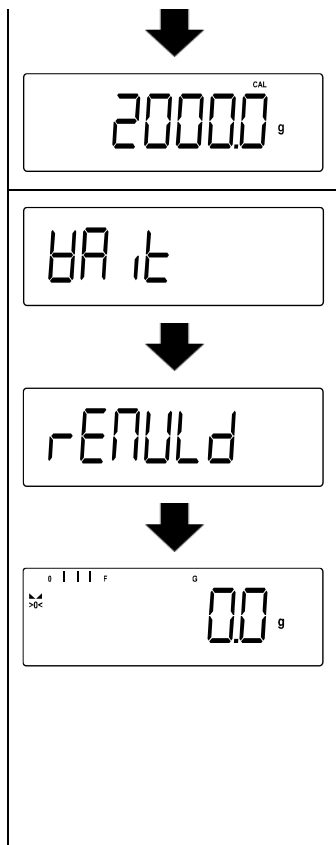

- ⇒ Place the adjustment weight.
- ⇒ <BAIt> followed by <rENULd> will be displayed.
- ⇒ Once <rENULd> is displayed, remove the adjustment weight.
- ⇒ After successful adjustment the balance automatically returns to weighing mode.
In case of an adjustment error (e.g. objects on the weighing plate) the display will show the error message <ErrOnG>. Switch off balance and repeat the adjustment process.

7.8.3 External adjustment with user-defined adjustment weight <cALEd>

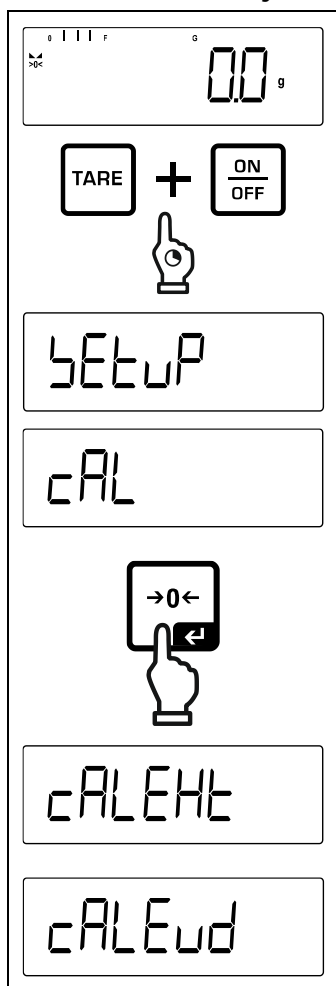

- ⇒ Press and hold the TARE and ON/OFF buttons simultaneously to enter the setup menu.
- ⇒ Wait until the first menu item <cAL> is displayed.
- ⇒ Confirm by [<0>] button, <cALEdt> will be displayed.
- ⇒ Use the navigation keys to select ↓ ↑ <cALEd>.

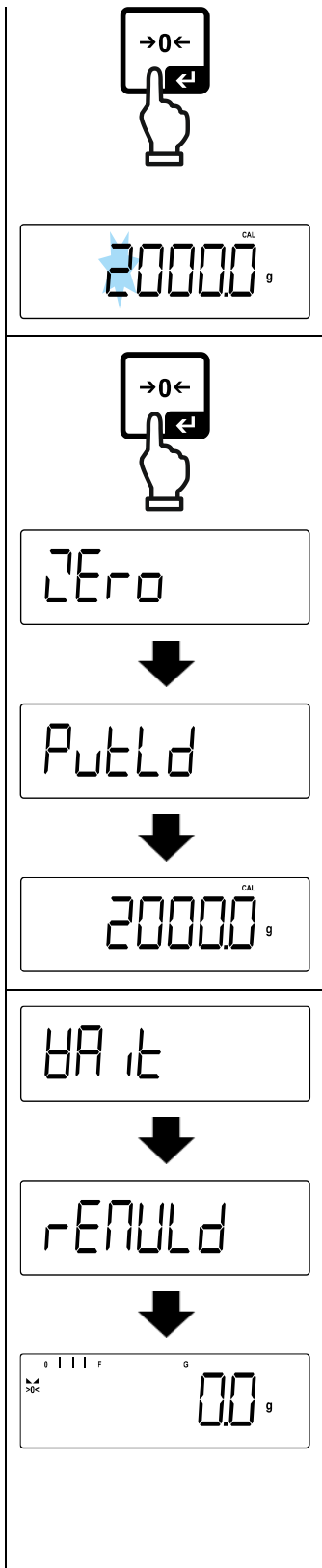

⇒ Acknowledge by [←] button. The numeric input window for the weight value of the adjustment weight appears. The active digit is flashing.

⇒ Provide adjustment weight.

⇒ Enter weight value, numerical input see chap. 3.2.2

⇒ Acknowledge selection by [←] button. < Zero >, < PutLd > followed by the weight value of the adjustment weight to be placed will be displayed.

⇒ Place the adjustment weight.

⇒ < Wait > followed by < rENULd > will be displayed.

⇒ Once < rENULd > is displayed, remove the adjustment weight.

⇒ After successful adjustment the balance automatically returns to weighing mode.

In case of an adjustment error (e.g. objects on the weighing plate) the display will show the error message < Error >. Switch off balance and repeat the adjustment process.

7.8.4 Gravitational constant adjustment location < GrAADJ >

⇒ Press and hold the TARE and ON/OFF buttons simultaneously to enter the setup menu.

⇒ Wait until the first menu item < cAL > is displayed.

⇒ Confirm by [→] button, < cAL EHT > will be displayed.

⇒ Use the navigation keys to select ↓ ↑ < GrAADJ >.

⇒ Acknowledge using [→] button, the current setting is displayed. The active digit is flashing.

⇒ Enter weight value and confirm using the [→] button, numerical input see chap. see chap. 3.2.2. Weighing balance returns to menu.

⇒ Press repeatedly ← button to exit menu.

7.8.5 Gravitational constant place of location < GrAuSE >

⇒ Press and hold the TARE and ON/OFF buttons simultaneously to enter the setup menu.

⇒ Wait until the first menu item < CAL > is displayed.

⇒ Confirm by [→] button, < CALHE > will be displayed.

⇒ Use the navigation keys to select ↓ ↑ < GrAuSE >.

⇒ Acknowledge using [→] button, the current setting is displayed. The active digit is flashing.

⇒ Enter weight value and confirm using the [→] button, numerical input see chap. 3.2.2. Weighing balance returns to menu.

⇒ Press repeatedly ← button to exit menu.

8 Verification

General:

According to EU directive 2014/31/EU balances must be officially verified if they are used as follows (legally controlled area):

- For commercial transactions if the price of goods is determined by weighing.
- For the production of medicines in pharmacies as well as for analyses in the medical and pharmaceutical laboratory.
- For official purposes
- For manufacturing final packages

In cases of doubt, please contact your local trade in standard.

Balances in the legally controlled area (-> verified balances) must keep the error limits in the verification validity period – normally they are the double of the verification error limits.

When this verification validity period expires, a re-verification must be carried out. Should be necessary an adjustment of the balance to keep the verification error limits to satisfy the re-verification requirements, this is not deemed a warranty case.

Verification notes:

An EU type approval exists for balances described in their technical data as verifiable. If the balance is used where obligation to verify exists as described above, it must be verified and re-verified at regular intervals.

Re-verification of a balance is carried out according to the respective national regulations. The validity for verification of balances in Germany is e.g. 2 years.

The legal regulation of the country where the balance is used must be observed!



Verification of the balance is invalid without the seal.

The seal marks attached on balances with type approval point out that the balance may only be opened and serviced by trained and authorised specialist staff. If the seal mark is destroyed, verification loses its validity. Please observe all national laws and legal regulations. In Germany a re-verification will be necessary.

Position of the official seals:

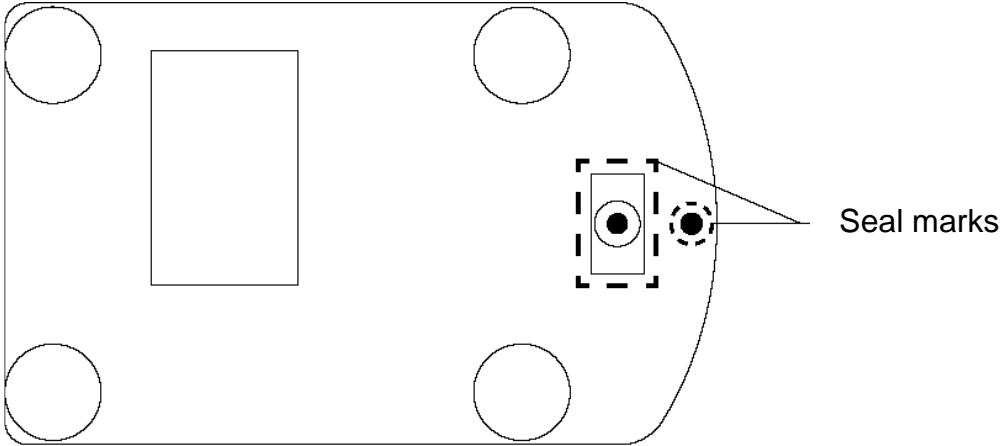

9 Basic Operation

9.1 Turn on/off

Start-up:

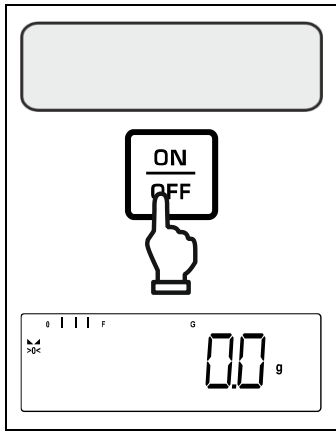

- ⇒ Press the **ON/OFF** button.
The display lights up and the balance carries out a selftest.
Wait until the weight display appears
The scales are now ready for operation using the last active application

Switching off:

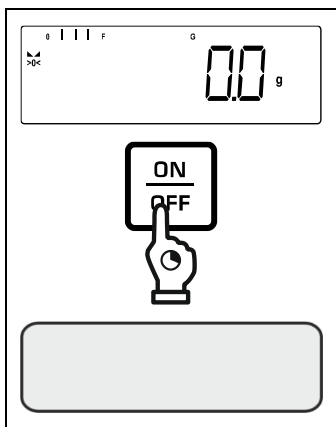

- ⇒ Keep **ON/OFF** button pressed until the display disappears

9.2 Simple weighing

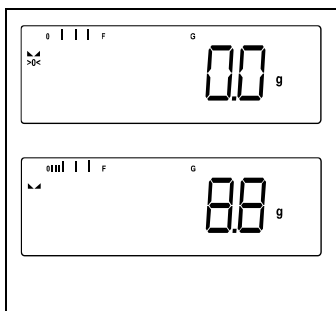

- ⇒ Check zero display [**>0<**] and set to zero with the help of the **ZERO** key, as required.
- ⇒ Place goods to be weighed on balance
- ⇒ Wait until the stability display appears (▬).
- ⇒ Read weighing result.



Overload warning

Overloading exceeding the stated maximum load (max) of the device, minus a possibly existing tare load, must be strictly avoided.
This could damage the instrument.

Exceeding the maximum load is indicated by the display “**f - - 7**”. Unload balance or reduce preload.

9.5 Switch-over weighing unit

Enable unit:

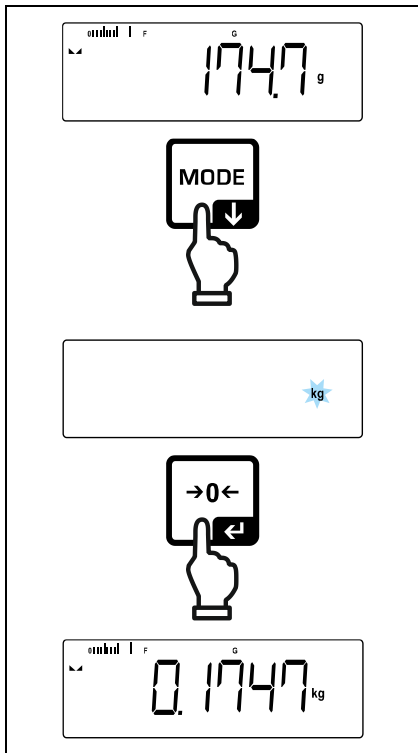

The unit for quick selection can be determined when the **[MODE]**-button is shortly pressed for the first time.

⇒ Press the **[MODE]**-button and wait until the display flashes.

⇒ Use the navigation keys $\uparrow\downarrow$ to select the weighing unit and confirm on **[←]**-button.

Switch over unit:

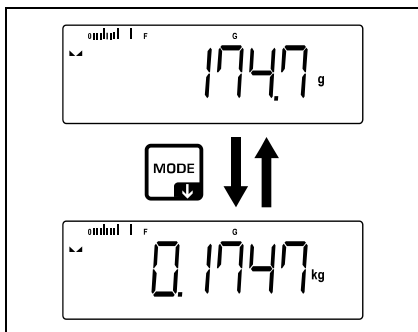

⇒ Using **[MODE]** button, it is possible to switch over between the enabled unit 1 and unit 2.

Enable another unit:

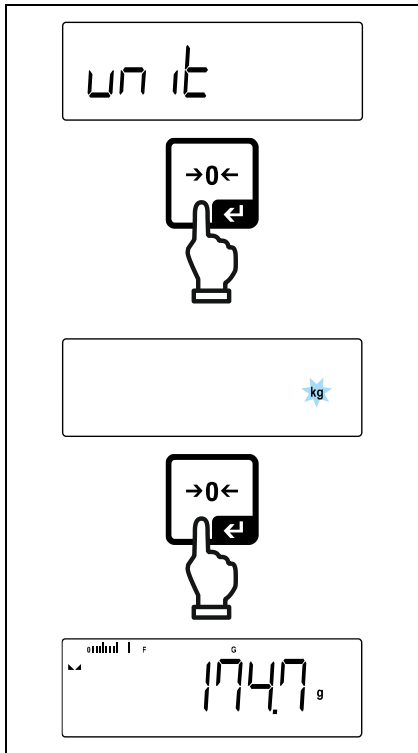

⇒ Select menu setting < unit > and confirm on [←] button.

⇒ Wait until the display flashes.

⇒ Use the navigation keys ↑ to select the weighing unit and confirm on [←] button.



- For the required settings of an application unit (FFA, %) selection, please see chap. 11.4.2 and 11.4.3.
- This menu setting deactivates the set unit for quick selection.

10 Operating concept

From factory the balance is delivered with various applications (weighing, check weighing, counting). After the first start-up the balance is in the <Weighing> application.

In the **application menu** (see chap.14.2.) however, you can define, selecting an application, in which mode the balance after switching-on has to continue working. Either as per standard in weighing mode or e.g. in check mode or counting mode.

Selecting an application:

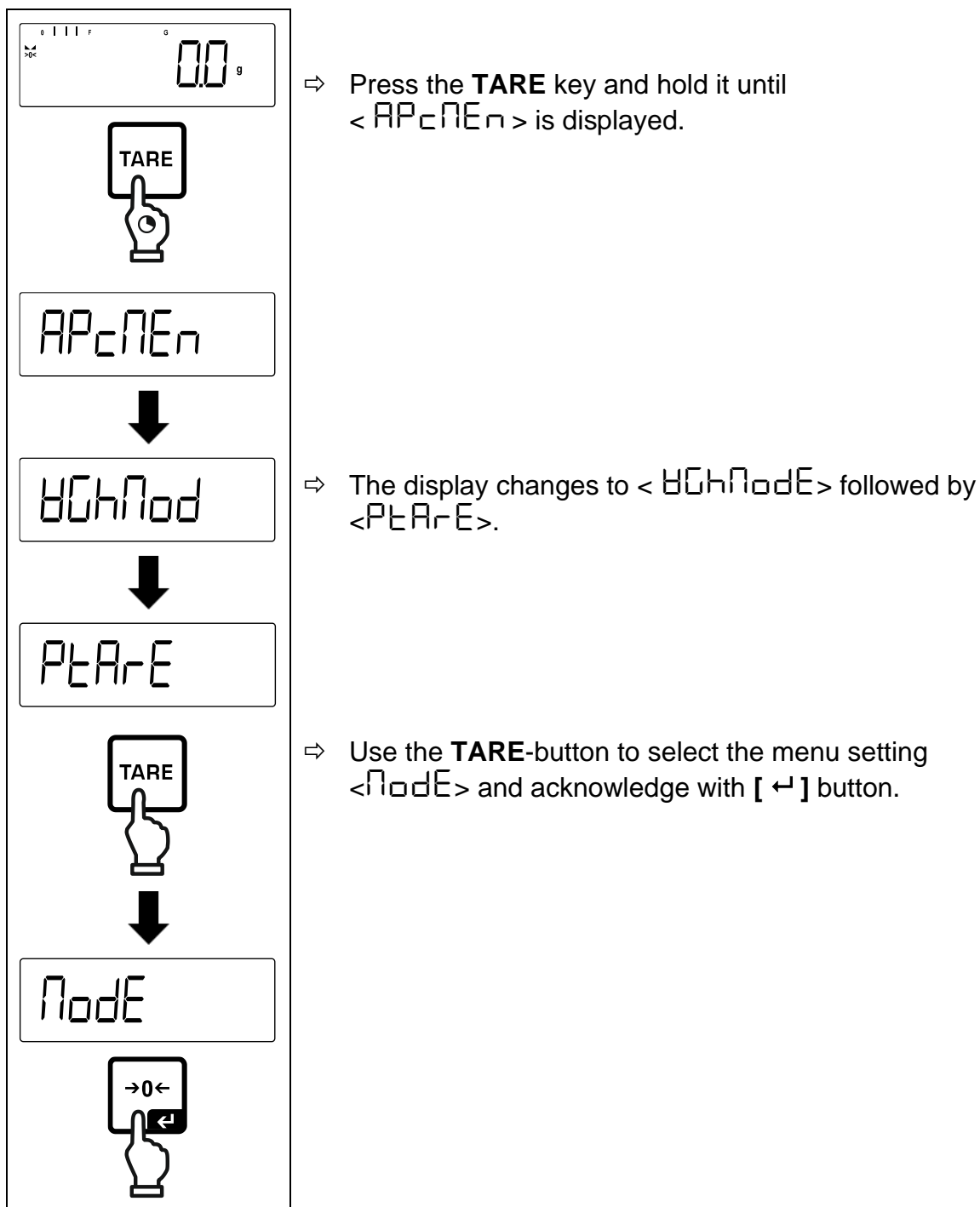

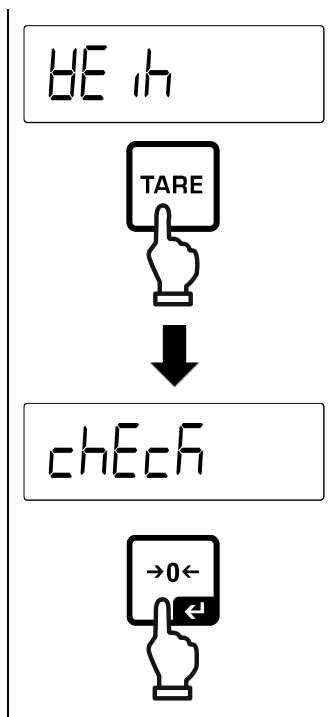

⇒ The last active application, e.g. < WE 1h > is displayed.

⇒ Use the **TARE**-button to select the desired application, selectable

WE 1h Weighing

count Counting

chEcf Check weighing

⇒ Acknowledge selection by [←] button.

According to the selected application in the application menu just appear the application-specific settings, so that you reach the target quickly without deviation.



- Information about the application-specific settings you will find in the description of the respective application.
- All basic settings and parameters, which influence the whole operation of the balance, are resumed in the **Setup Menu** (see chap.14.3) These settings remain valid for all applications.
- The number of the available applications depends on the model.

Change application:

- ⇒ Press the **TARE** button and keep it pressed until the first menu item of the application menu will be displayed
- ⇒ Use the ↓ button to select the menu setting < Mode > and acknowledge with [←] button. The current setting will be displayed.
- ⇒ Press the ↓ button to select the required unit and confirm by pressing the [←] button.

11 Application <Weighing>

How to carry out a simple weighing and taring, please refer to chap. 9.2 or 9.4. Further specific settings you will find in the following chapters.

i Shouldn't the application <Weighing> already be enabled, select the menu setting < **ModE** > → < **WE ih** >, see chap. 10.

11.1 Application-specific settings

Call up menu:

- ⇒ Press the **TARE** key and hold it until < **APPcNEr** > is displayed.
- ⇒ The display changes to < **WGHMod** > followed by < **PRErE** >.
- ⇒ Navigation in menu see chap. 14.1

Overview (not verifiable models):

Level 1	Level 2	Level 3	Description / Chapter
PRErE PRE-TARE	ACTUAL		Take over the placed weight as PRE-TARE value,, see chap. 11.2.1
	NUMAL		Numerical input of the tare weight, see chap. 11.2.2
	CLAr		Delete PRE-TARE value
hold	-		Start-Hold function, see chap. 11.3
un it Units	available weigh- ing units, see chap. 1		This function defines in which weighing unit the result will be displayed, see chap. 11.4.1
	pcs		Application unit counting
	FFA		Multiplication factor see chap. 11.4.2
	%		Application unit for determining percentages see chap. 0
ModE Applications	WE ih	Weighing	see chap. 10
	count	Counting	
	chEcH	Check weighing	

Overview (verifiable models):

Level 1	Level 2	Level 3	Description / Chapter
PRE-TARE	ACTUAL	Take over the placed weight as PRE-TARE value,, see chap. 11.2.1	
	NUMAL	Numerical input of the tare weight, see chap. 11.2.2	
	CLEAR	Delete PRE-TARE value	
hold	-	Start-Hold function, see chap. 11.3	
Units	g	This function defines in which weighing unit the result will be displayed, see chap. 11.4.1	
	ct		
Applications	WEIGH	Weighing	see chap. 10
	COUNT	Counting	
	CHECK	Check weighing	

11.2 PRE-Tare

11.2.1 Take over the placed weight as PRE-TARE value

< P T A R E > → < A C T U A L >

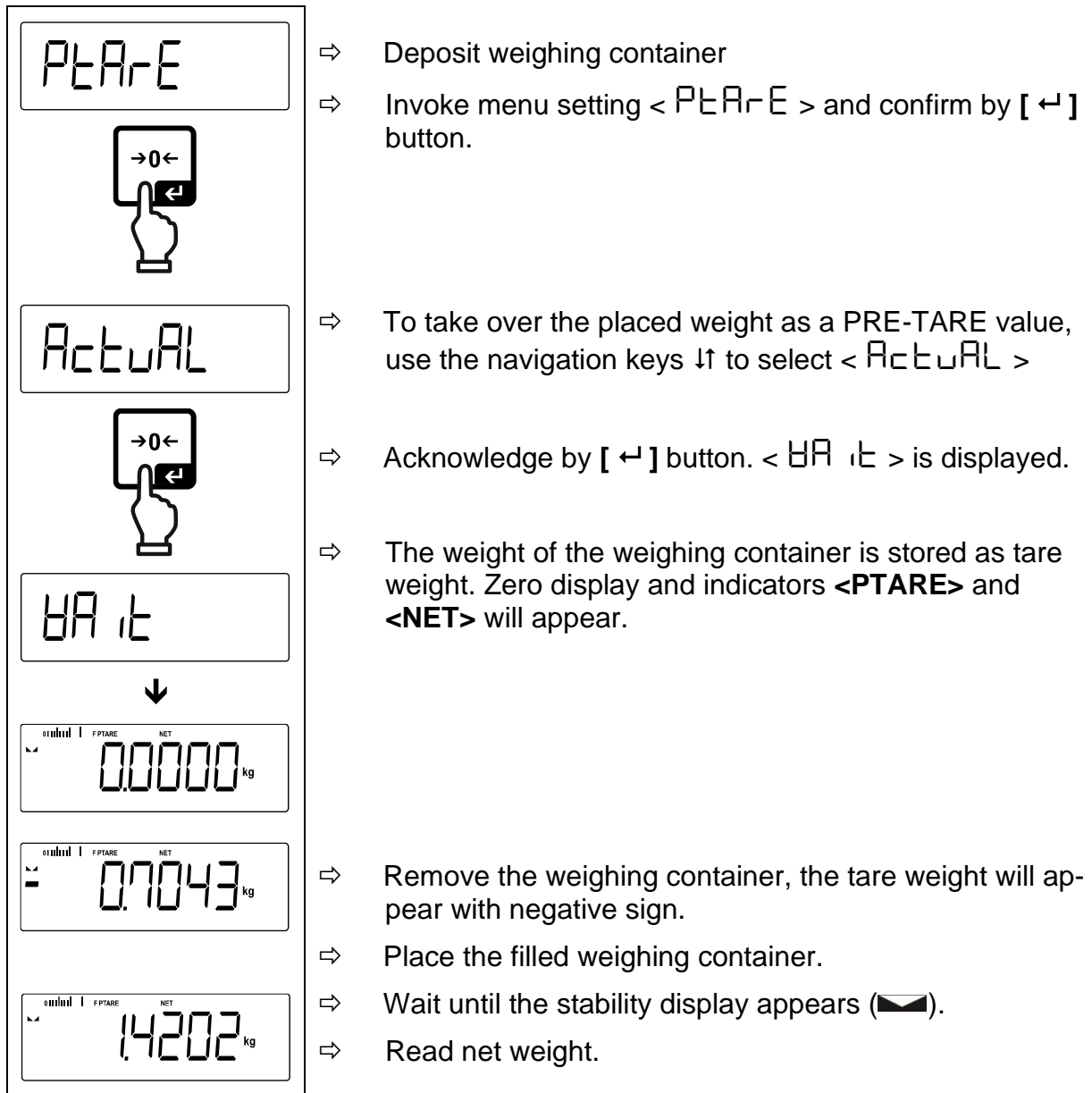

i The entered tare weight remains valid until a new tare weight is input. To delete press the TARE key or confirm the menu setting < C L E A R > using the [←] button.

11.2.2 Enter the known tare weight numerically

< PTARE > → < NARNAL >

	⇒ Invoke menu setting < P <small>T</small> A <small>R</small> E > and confirm by [←] button.
	⇒ Using the navigation keys ↓↑ select the setting Select < N <small>A</small> R <small>N</small> A <small>L</small> > and confirm by pressing the [←] button.
	⇒ Enter known tare weight, numerical input see chap. 3.2.2, the active digit flashes.
	⇒ The input weight is saved as tare weight, the indicators < PTARE > and < NET > and the tare weight with minus sign will appear.
	⇒ Place the filled weighing container. ⇒ Wait until the stability display appears (▢). ⇒ Read net weight.

i The entered tare weight remains valid until a new tare weight is input. To delete enter the zero value or confirm the menu setting < CLEAR > using the [←] button.

11.3 Data-Hold function

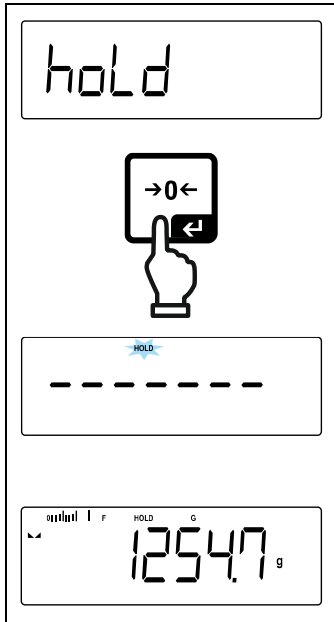

- ⇒ Menu setting < hold >
- ⇒ Place goods to be weighed.
- ⇒ Acknowledge by [←] button.
- ⇒ The first stable weight value is symbolised by [HOLD] in the upper edge of the display. After the load is removed, the value is left in the display for another 10 seconds.

11.4 Weighing Units

11.4.1 Setting weighing unit

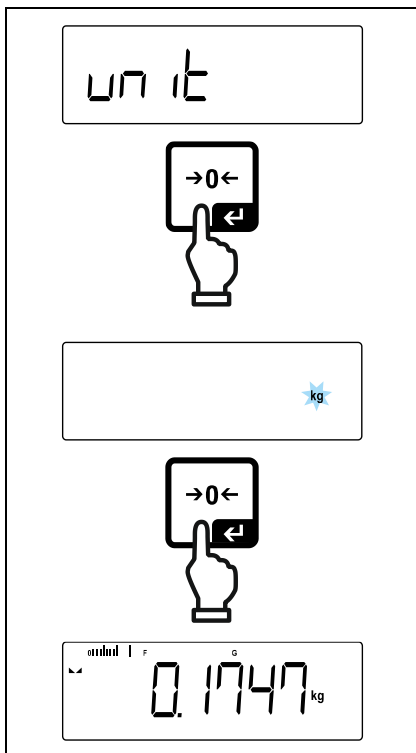

- ⇒ Select menu setting < unit > and confirm on [←] button.
- ⇒ Wait until the display flashes.
- ⇒ Use the navigation keys ↓↑ to select the weighing unit and confirm on [←] button.



- For the required settings of an application unit (FFA, %) selection, please see chap. 11.4.2 and 11.4.3.
- Using the **[MODE]** button you can switch between the active unit 1 and unit 2.

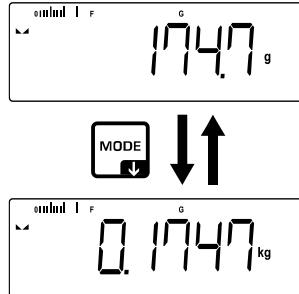

11.4.2 Weighing with multiplication factor via the application unit <FFA>

Here you determine with which factor the weighing result (in gram) will be multiplied.

By that way, e.g. a known error factor in the weight determination can be immediately taken into account.

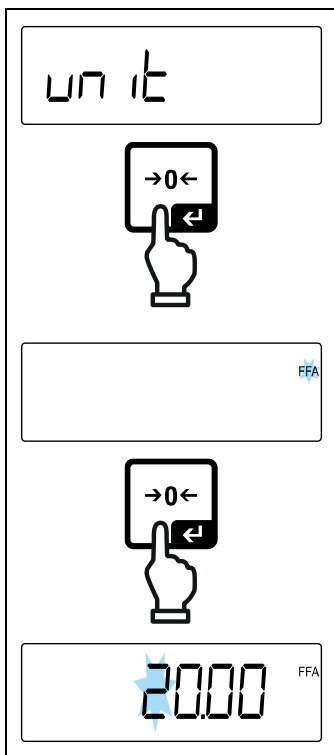

⇒ Select menu setting < unit > and confirm on [←] button.

⇒ Use the navigation keys ↓ to select the setting < FFA > and confirm on [←] button.

⇒ Enter multiplication factor, numerical input see chap. 3.2.2, the active digit flashes.

11.4.3 Percent weighing by application unit <%>

The application unit <%> allows to check the weight of a sample in percent, based on a reference weight.

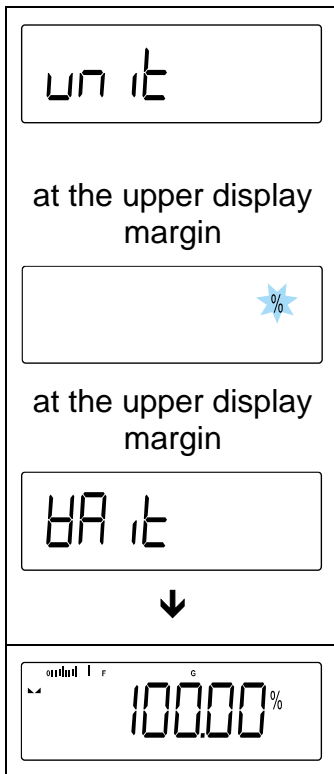

- ⇒ Select menu setting < unit >.
- ⇒ Place a reference weight which corresponds to 100 %
- ⇒ Acknowledge by [←] button.
- ⇒ Use the navigation keys ↓↑ to select the setting < % > and confirm on [←] button.
- ⇒ From now on the weight of the sample will be shown in percent based on the reference weight

11.4.4 Molar weighing mode

This function calculates the amount of a substance (in mol) based on the molar mass and the weight of the substance.

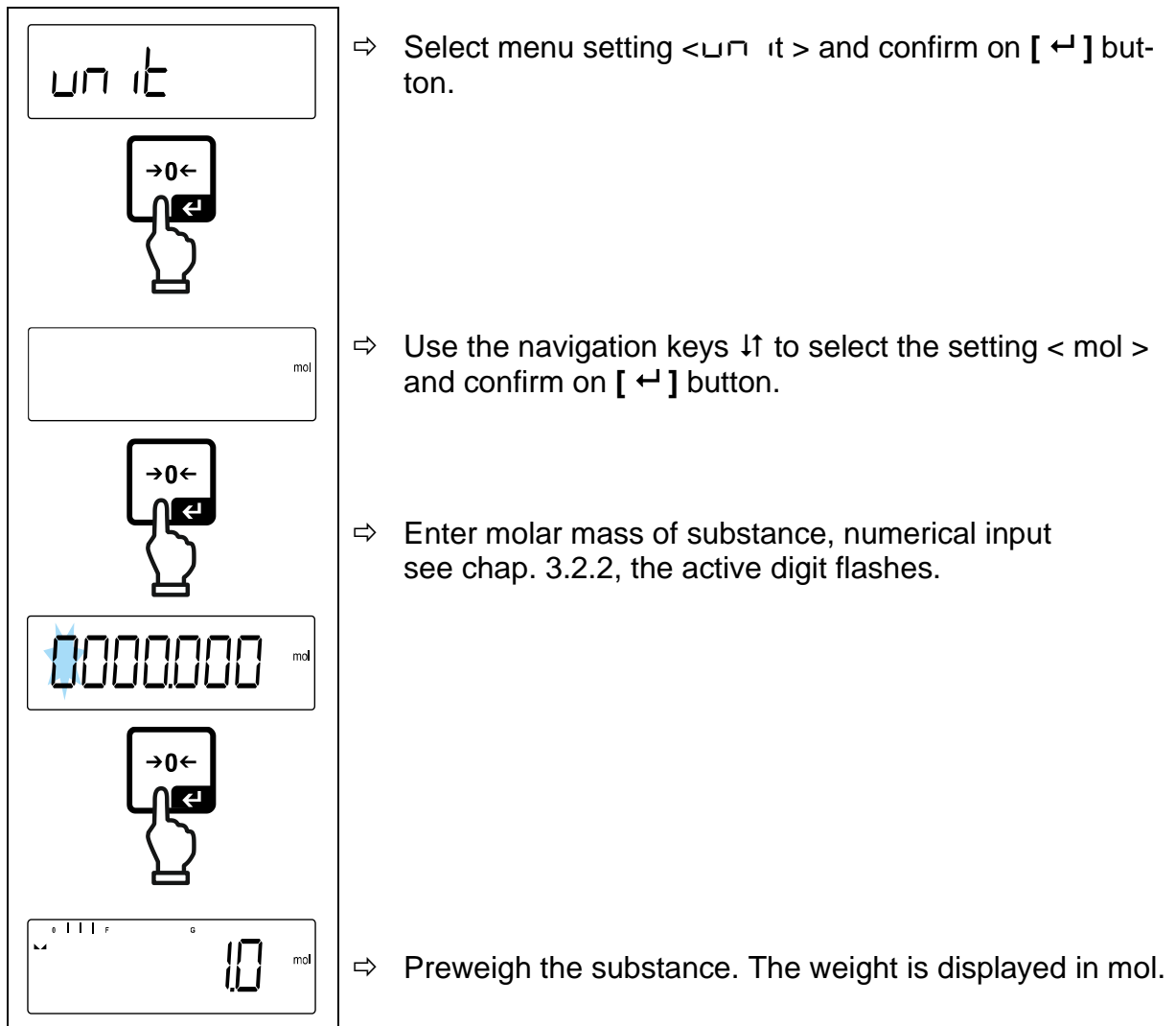

12 Application <Counting>



Shouldn't the application <Counting> already be enabled, select the menu setting < Mode > → < count >, see chap. 10

12.1 Application-specific settings

Call up menu:

- ⇒ Press the **TARE** key and hold it until < APcNEN > is displayed.
- ⇒ The display changes to < couMod > followed by < rEF >.
- ⇒ Navigation in menu see chap. 14.1

Overview:

Level 1	Level 2	Level 3	Description / Chapter
rEF Reference quantity	5	Reference quantity 5	
	10	Reference quantity 10	
	20	Reference quantity 20	
	50	Reference quantity 50	
	FrEE	Optional, numerical input, see chap. 3.2.2	
	inPut	Input of piece weight, numerical input, see chap. 3.2.2	
PrArE PRE-TARE	ActUAL	Take over the placed weight as PRE-TARE value, see chap.11.2.1	
	NUMAL	Numerical input of the tare weight, see chap. 11.2.2	
	cLEAR	Delete PRE-TARE value	
tArGEt Target counting	VALUE	Target quantity	see chap. 12.2.2
	ErrUPP	Upper tolerance	
	ErrLoB	Lower tolerance	
	cLEAR	Delete settings	
ModE Applications	count	Counting	see chap. 10
	chEcK	Check weighing	
	WE ih	Weighing	

12.2 Using the application

12.2.1 Piece counting

Before the balance can count parts, it must know the average part weight (i.e. reference). Proceed by putting on a certain number of the parts to be counted. The balance determines the total weight and divides it by the number of parts, the so-called reference quantity. Counting is then carried out on the basis of the calculated average piece weight.

- i** • The higher the reference quantity the higher the counting exactness.
- Especially high reference must be selected for small parts or parts with considerably different sizes.
- Smallest counting weight see table „Technical data“.

1. Set reference

Reference quantity 5, 10, 20 or 50:

	⇒ If necessary, put on and tare the weighing container.
	⇒ Put on the desired quantity of reference pieces.
	⇒ Invoke menu setting < REF > and confirm by [←] button.
	⇒ Use the navigation keys ↑↓ to select the reference piece quantity (5, 10, 20, 50) according to the placed reference and confirm with the [←] button.
	⇒ The balance will calculate the average item weight and then displays the quantity of pieces.
	⇒ Remove reference weight. The balance is now in piece counting mode counting all units on the weighing plate.

Reference quantity user-defined:

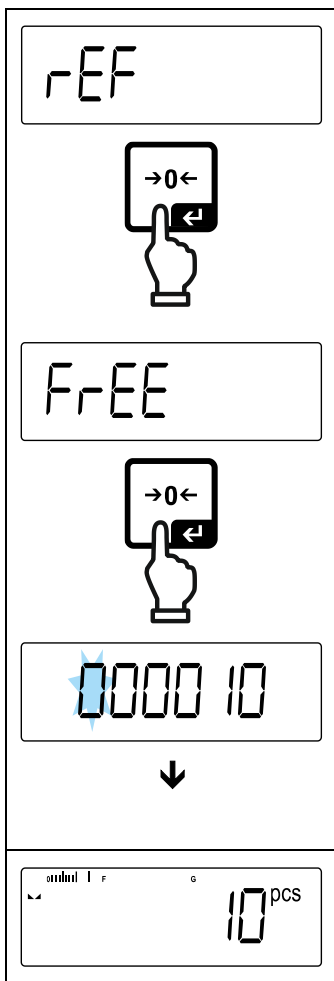

- ⇒ If necessary, put on and tare the weighing container.
- ⇒ Put on the desired quantity of reference pieces.
- ⇒ Invoke menu setting < ref > and confirm by [←] button.
- ⇒ Use the navigation keys ↓ to select the setting < FrEE > and confirm on [←] button.
- ⇒ The numeric input window appears.
- ⇒ Enter and confirm the quantity of the placed reference parts, numerical input see chap. 3.2.2
- ⇒ The balance will calculate the average item weight and then displays the quantity of parts.
- ⇒ Remove reference weight. The balance is now in piece counting mode counting all units on the weighing plate.

Counting with optional piece weight:

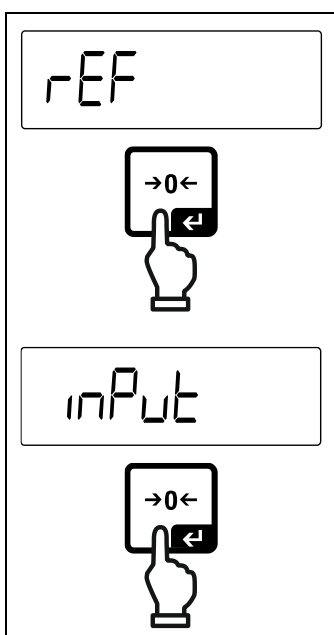

- ⇒ Invoke menu setting < rEF > and confirm on [←] button.
- ⇒ Use the navigation keys ↓ to select the setting < input > and confirm on [←] button.
- ⇒ Use the navigation keys ↓ to select the weighing unit and confirm on [←] button.

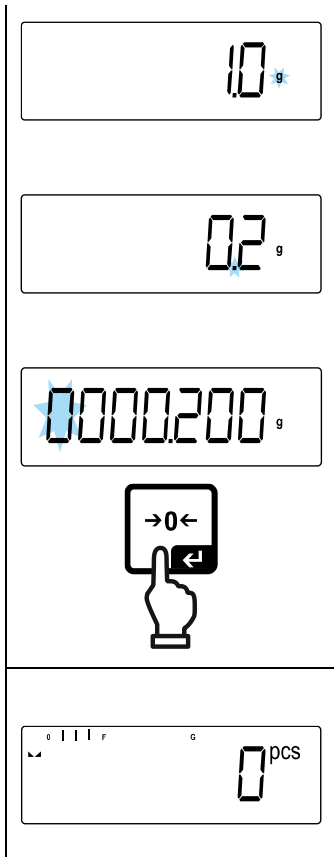

⇒ Use the navigation keys ↓ to select the comma position and confirm on [←] button.

⇒ Enter piece weight, numerical input see chap. 3.2.2, the active digit flashes.

⇒ Acknowledge by [←] button.

The balance is now in piece counting mode counting all units on the weighing plate.

2. Parts counting

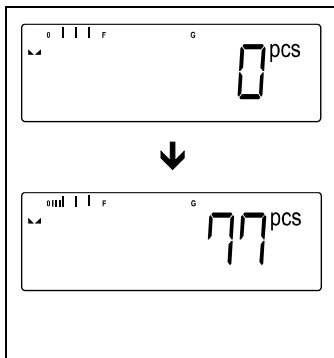

⇒ If necessary, put on and tare the weighing container.

⇒ Fill the counting quantity. The piece quantity is shown directly in the display.



12.2.2 Target counting

The <Target counting> application variant allows weighing of goods within set tolerance limits in keeping with a determined target quantity.

Reaching the target quantity is indicated by an acoustic (if activated in menu) and an optic signal (tolerance marks).

Optical signal:

The tolerance marks provide the following information:







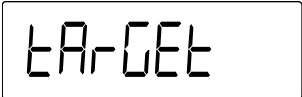

	Target quantity exceeds defined tolerance
	Target quantity within defined tolerance
	Target quantity below defined tolerance

Acoustic signal:

The acoustic signal depends on the menu setting <SETUP → BEEPER >, see chap. 14.3.1.

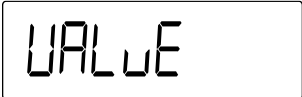
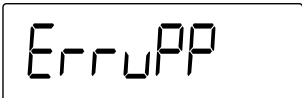
Procedure:

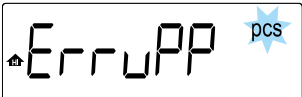
1. Define target quantity and tolerances

	⇒ Make sure that the scale is in counting mode and that an average piece weight has been defined (see chap. 12.2.1).
	⇒ Use the navigation keys ↓ to select the setting < TARGET > and confirm with [←] button.
	< VALUE > is displayed.
	
	⇒ Confirm on [←] button, the numeric input window appears. The active digit is flashing.
	⇒ Enter the target quantity (numerical input see chap. 3.2.2) and confirm the entry.
↓	The balance returns to the < VALUE > menu.
	
	⇒ Use the navigation keys ↓ to select the setting < ERRUPP > and confirm on [←] button.
	⇒ Use the navigation keys ↓ to select the weighing unit and confirm on [←] button.
	
	⇒ The numeric input window appears. The active digit is flashing.
	⇒ Enter the upper tolerance (for numerical input see chap. 3.2.2) and confirm the entry.
↓	

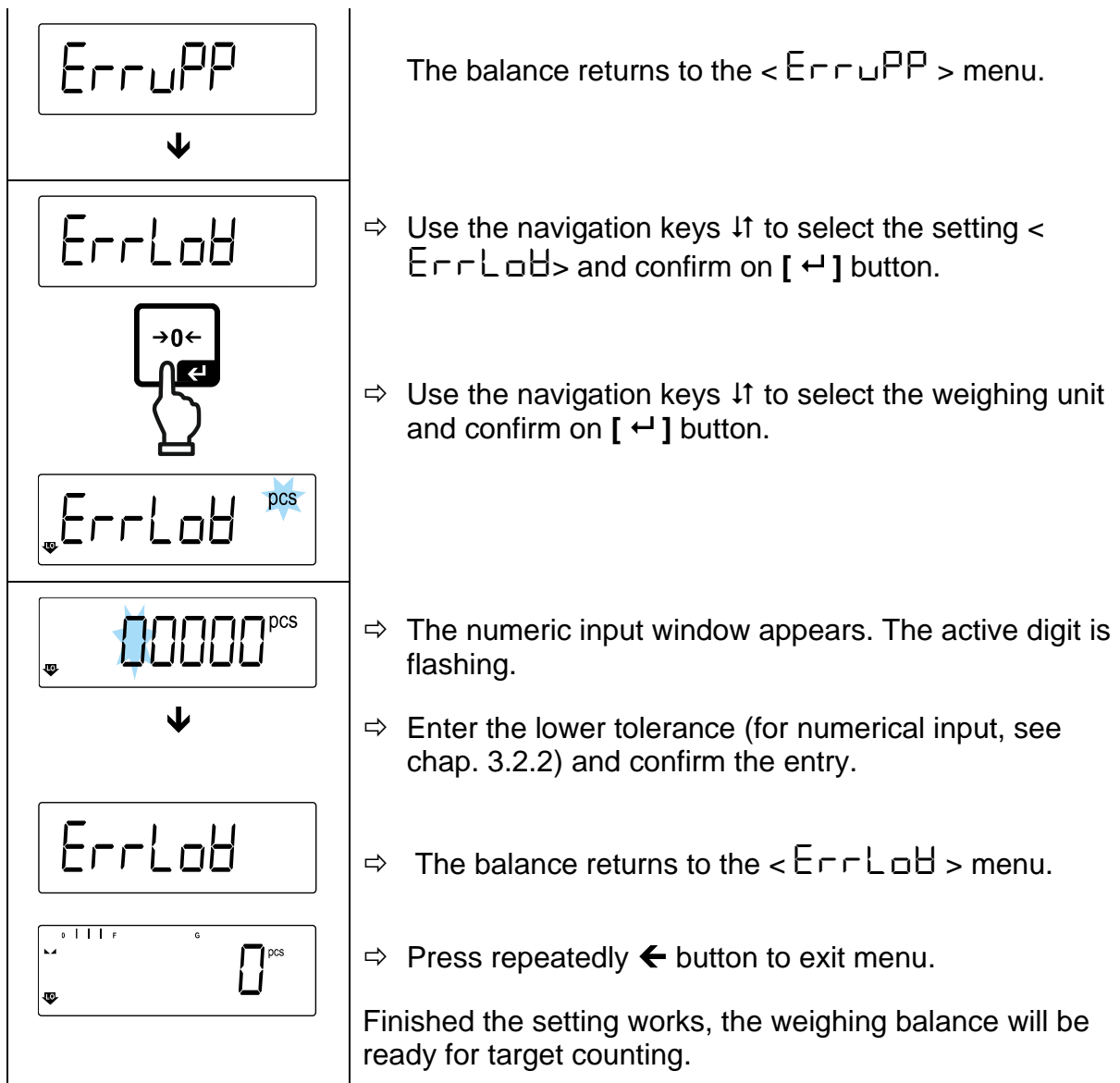

2. Start tolerance check:

- ⇒ Determine the average piece weight, see chap. 12.2.1
- ⇒ Place the weighed material and check by means of the tolerance marks / acoustic signal if the weighed material is within the defined tolerance.

Load below specified tolerance	Load within specified tolerance	Load exceeds specified tolerance



The entered values will remain valid until new values are entered.

To delete the values, select menu setting <ErGEt> \rightarrow <CLAR> and confirm on [\leftarrow] button.

13 Application < Checkweighing >



Shouldn't the application <Checkweighing> already be enabled, select the menu setting < **Mode** > → < **check** >, see chap. 10

13.1 Application-specific settings

Call up menu:

- ⇒ Press the **TARE** key and hold it until < **APCnEn** > is displayed.
- ⇒ The display changes to < **checkMod** > followed by < **TARGET** >.
- ⇒ Navigation in menu see chap. 14.1

Overview:

Level 1	Level 2	Level 3	Description / Chapter
TARGET Target weighing, see chap. 13.2.1	VALUE	Target weight, numerical input, see chap. 3.2.2	
	ERRUPP	Upper tolerance, numerical input see chap. 3.2.2	
	ERRLoB	Lower tolerance, numerical input see chap. 3.2.2	
	clear	Delete settings	
LIMITS check weighing, see chap. 13.2.2	LUPP	Upper limit value, numerical input see chap. 3.2.2	
	LLoB	Lower limit value, numerical input see chap. 3.2.2	
	clear	Delete settings	
PRE-TARE PRE-TARE	ACTUAL	Take over the placed weight as PRE-TARE value, see chap.11.2.1	
	NUMAL	Numerical input of the tare weight, see chap. 11.2.2	
	clear	Delete PRE-TARE value	
Mode Applications	WE ih	Weighing	see chap. 10
	count	Counting	
	check	Check weighing	

13.2 Using the application



13.2.1 Target weighing

The <target weighing> application variant allows weighing of goods within set tolerance limits in keeping with a determined target weight.

Reaching the target weight is indicated by an acoustic (if activated in menu) and an optic signal (tolerance marks).

Optic signal:

The tolerance marks provide the following information:

	Upper limit
	Target weight
	Lower limit

Acoustic signal:

The acoustic signal depends on the menu setting < SETUP → BEEPER >, see chap. 14.3.1.

Procedure:

1. Define target weight and tolerances

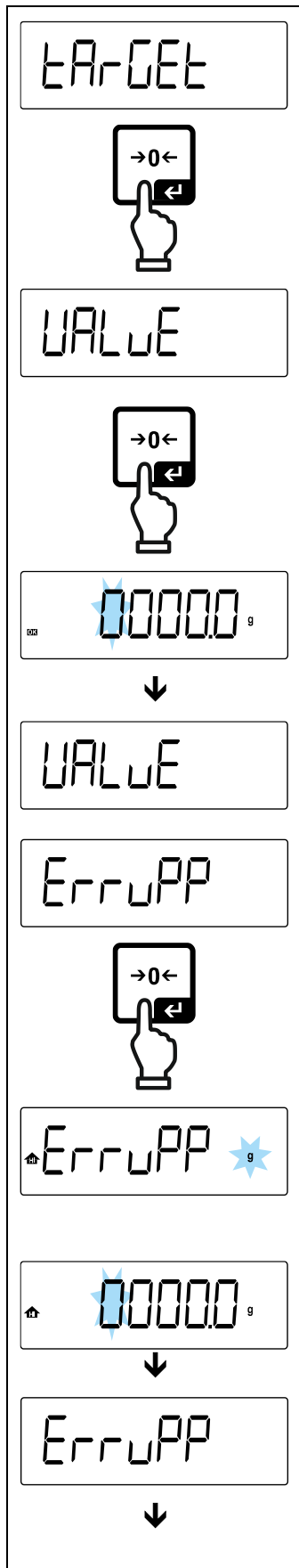

⇒ Use the navigation keys \downarrow to select the setting **< TARGET >** and confirm with [\leftarrow] button.

< VALUE > is displayed.

⇒ Confirm on [\leftarrow] button, the numeric input window appears. The active digit is flashing.

⇒ Enter target weight (numerical input see chap. 3.2.2) and confirm the entry.

The balance returns to the **< VALUE >** menu.

⇒ Use the navigation keys \downarrow to select the setting **< ERRUPP >** and confirm on [\leftarrow] button.

⇒ Use the navigation keys \downarrow to select the weighing unit and confirm on [\leftarrow] button.

⇒ The numeric input window appears. The active digit is flashing.

⇒ Enter the upper limit for the weight deviation (numerical input see chap. 3.2.2) and confirm the entry.

The balance returns to the **< ERRUPP >** menu.

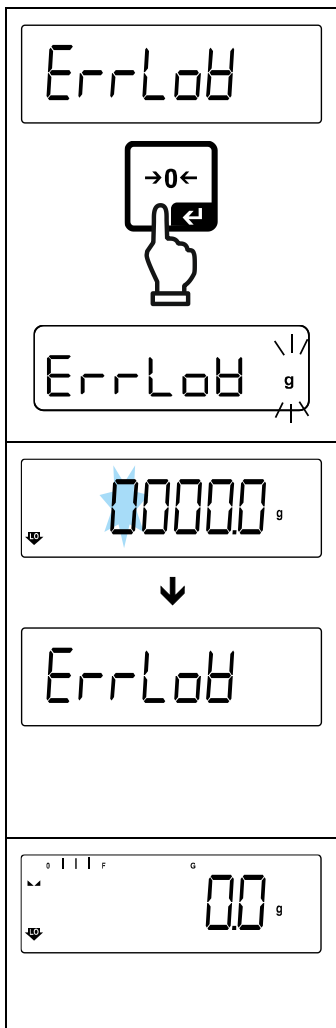

⇒ Use the navigation keys ↓↑ to select the setting < Err - Lob > and confirm on [←] button.

⇒ Use the navigation keys ↓↑ to select the weighing unit and confirm on [←] button.

⇒ The numeric input window appears. The active digit is flashing.

⇒ Enter lower limit for weight deviation (numerical input see chap. 3.2.2) and confirm the entry.

⇒ The balance returns to the < ErrLob > menu.

⇒ Press repeatedly ← button to exit menu.

Finished the setting works, the weighing balance will be ready for checkweighing.

3. Start tolerance check:

⇒ Place the weighed material and check by means of the tolerance marks / acoustic signal if the weighed material is within the defined tolerance.

Load below specified tolerance	Load within specified tolerance	Load exceeds specified tolerance



The entered values will remain valid until new values are entered.

To delete the values, select menu setting < TARGET > → < CLEAR > and confirm on [←] button.



13.2.2 Checkweighing

With the <Checkweighing> application variant you can check if the weighing good is within a predefined tolerance range.

When limit values are exceeded below or above, an acoustic signal (if enabled in menu) will sound and an optic signal (tolerance marks) will be displayed

Optic signal:

The tolerance marks provide the following information:

	Weighed-in goods exceed predefined tolerance
	Weighed-in goods within predefined tolerance
	Weighed-in goods below predefined tolerance

Acoustic signal:

The acoustic signal depends on the menu setting <SEtUP> → <BEEPER>, see chap. 14.3.1.

Procedure:

1. Define limit values

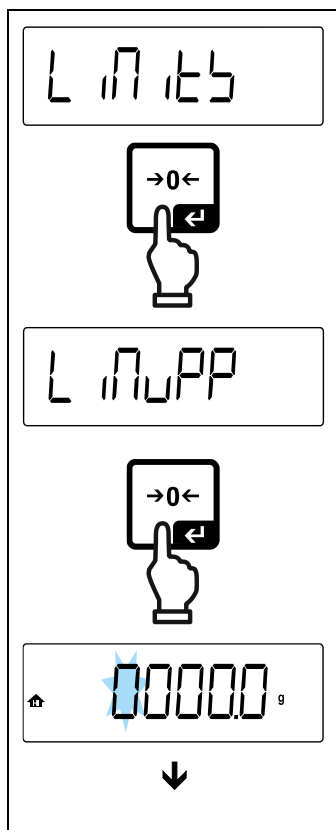

⇒ Using the navigation keys ↑ select the setting
Select <LIMITS> and confirm on [←] button.

<LIMITS> will appear.

⇒ Press [←] button to confirm, the numeric input window for entering the upper limit value will appear.
The active digit is flashing.

⇒ Enter upper limit value (numerical input see chap. 3.2.2) and confirm the entry.

The balance returns to the <LIMITS> menu.

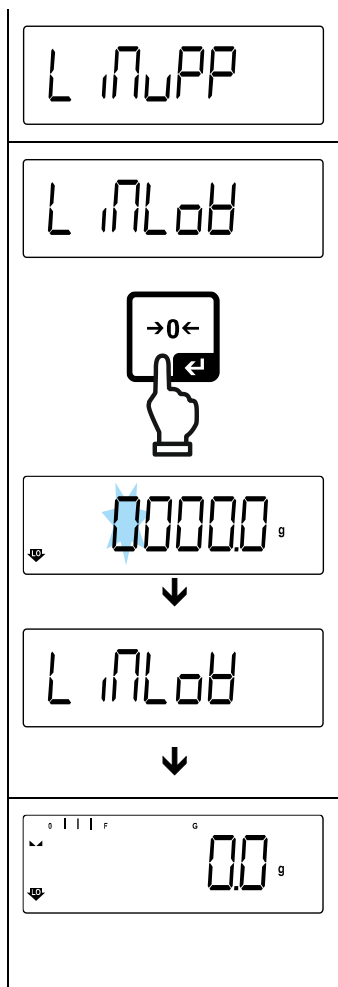

⇒ Use the navigation keys ↓ to select setting < L INLoB >.

⇒ Press [←] button to confirm, the numeric input window for entering the lower limit value will appear. The active digit is flashing.

⇒ Enter lower limit value (numerical input see chap. 3.2.2) and confirm the entry.

The balance returns to the < L INLoB > menu.

⇒ Press repeatedly ← button to exit menu.

Finished the setting works, the weighing balance will be ready for checkweighing.

2. Start tolerance check:

⇒ Place the weighed material and check by means of the tolerance marks / acoustic signal if the weighed material is within the defined tolerance.

Load below specified tolerance	Load within specified tolerance	Load exceeds specified tolerance



The entered values will remain valid until new values are entered.

To delete the values, select menu setting < L IN tS > → < CLEAR > and confirm on [←] button.

14 Menü

14.1 Navigation in the menu

Call up menu:

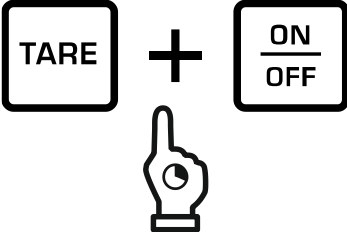
Application menu	Setup menu
 <p>Press the TARE button and keep it pressed until the first menu item will be displayed</p>	 <p>Press the TARE and ON/OFF button at the same time and keep them pressed until the first menu item will be displayed</p>

Select and adjust parameters:

<p>Scrolling on one level</p>	<p>Use the navigation buttons to select the individual menu blocks one by one.</p> <p>Use the navigation key ↓ to scroll down.</p> <p>Use the navigation key ↑ to scroll up.</p>
<p>Activate menu item / Confirm selection</p>	<p>Press navigation key →</p>
<p>Menu level back / back to weighing mode</p>	<p>Press navigation key ←</p>

14.2 Application menu

The application menu allows you a fast and targeted access to the respectively selected application (see chap. 10).



An overview of the application-specific settings you will find in the description of the respective application.

14.3 Setup menu

In the setup menu you have the possibility to adapt the behaviour of the balance to your requirements (e.g. environmental conditions, especial weighing processes).

These settings are global and do not depend on the selected application.

14.3.1 Overview < SETUP >

Not verifiable models:

Level 1	Level 2	other levels / description	
		Description	
cAL Adjustment	cALEHt	→ External adjustment, see chap. 7.8.2	
	cAL int	→ Internal adjustment, see chap. 7.8.1	
	cALEud	→ External adjustment, user-defined, see chap. 7.8.3	
	GrAADJ	→ Gravity constant adjustment site, see chap.7.8.4	
	GrAubE	→ Gravity constant installation site, see chap. 7.8.5	
com Communication	r5232 ↓ usb-d	bAud	1200
			2400
			4800
			9600
			14400
			19200
			38400
			57600
			115200
			128000
			256000
		dAtA	7db dB
			8db dB
	PAR tY	nonE	
		odd	
		EUEn	
	btoP	15b t	
		25b t	
	hAndsh	nonE	
	Protoc	RcP	
bt-b	btbEt	on, oFF	
		Bluetooth on / off	
	btNAME	Device name displayed in the Bluetooth network	

Print Data output	intFcE		rs232	RS 232 interface		
			usb-d	USB-Schnittstelle		
	sum		on	Switch on / off add-up mode, see chap. 15.5.1		
			off			
	PrNode	trig	MANUAL	on, off Data output by pressing the PRINT button, see chap. 15.5.2		
			AutoPr	on, off Automatic data output with stable and positive weighing value see chap.15.5.3. Another output only af- ter zero display and stabilisation, de- pending on the settings < ZRANGE >, selectable (off, 1, 2, 3,4,5). < ZRANGE > defines the factor for d. This factor multiplied with d results in the threshold; when it is exceeded, a value cannot more be con- sidered as stable.		
		cont	on	off	Continuous data output	
				SPEED	Setting output interval see chap. 15.5.4	
				ZERO	on, off 0 (unloaded) also transmit continuously	
		WEIGHT	GntPrnt	STABLE	on, off Transmit stable values only	
				WGLPrnt	on, off Displayed weight value is transmitted	
				Gross	on, off	
				Net	on, off	
		LAYOUT	nonE	tarE	on, off	
	ForNAt			Long (detailed measu- rement protocol) Short (standard mea- surement protocol)		
	uSer	nonE	Model	on, off Output model designation of the scale		
Serial			on, off Output serial number of the scale			
reSet	Delete settings					

bEEPEr Acoustic signal	REYb	oFF	Switch on / off acoustic signal by pressing button		
		on			
	chEcH	ch-on	oFF	Acoustic signal off	
			bLoB	Slow	
			bEd	Standard	
			FASt	Fast	
			cont.	Continuous	
		ch-Lo	oFF	Acoustic signal off	
			bLoB	Slow	
			bEd	Standard	
			FASt	Fast	
			cont.	Continuous	
		ch-hi	oFF	Acoustic signal off	
			bLoB	Slow	
	bEd		Standard		
FASt	Fast				
cont.	Continuous				
AutoFF Automatic switch-off function in rechargeable battery operation	Node	oFF	Automatic switch-off function switched off		
		Auto	The balance is automatically switched-off according to the time without load change or without operation defined in menu item < t .nE >		
		onLY0	Automatic switch-off only with zero display		
	t .nE	30b	After the set time without load change or operation the balance will switch off automatically		
		1n in			
		2n in			
		5n in			
		30n in			
	60n in				

ԵԼ ԴԻԷ Display background illumination	ՈճԷ	ALWAYS	Background lighting of display is switched on permanently
		Է ՈՔԻ	The background illumination is automatically switched-off according to the time without load change or without operation defined in menu item < Է ՈՔԻ >
		ոՅԼ	Display background illumination always switched off
	Է ՈՔԷ	55	Definition, after which time the background illumination is automatically switched-off without load change or without operation.
		105	
		305	
		1Ո յ	
2Ո յ			
5Ո յ			
30Ո յ			
ԷՐԷԲԸ Taring range	100% ⇕ 10%	Definition max. taring range, selectable 10% - 100%. Numerical input see chap. 3.2.2	
ՉԷՐԱՇԻ Zerotracking	ՕՈ	Automatic zero tracking [≤3d]	
	ՕՐԲ		In the event that small quantities are removed or added to the material to be weighed, incorrect weighing results can be displayed due to the “stability compensation”. (e.g. slow flow of liquids from a container placed on the balance, evaporating processes). When apportioning involves small variations of weight, it is advisable to switch off this function.
ՍՈ ԷՆ Units	available weighing units / application units, see chap. 1	ՕՈ, ՕՐԲ	Using this function you can define which weighing units are available in the application-specific menu < ՍՈ ԷՆ >. The units selected by < ՕՈ > are available in the application-specific menu.
ՈճԷ Weighing applications	ԿԷ ի	Weighing	
	ԸՕՍՆԷ	Counting	
	ՇԻԷՇԻ	Check weighing	
ԲԷՆԷԷ	Reset balance settings to factory settings		

Verifiable models:

Level 1	Level 2	other levels / description	
		Description	
cAL Adjustment	cAL int	→ Internal adjustment, see chap. 7.8.1	
c0n Communication	r5232 ⚡ usb-d	bAud	1200
			2400
			4800
			9600
			14400
			19200
			38400
			57600
			115200
			128000
			256000
	dAtA	7db dB	
		8db dB	
	PAR ity	nonE	
		odd	
		EUEr	
	5toP	15b it	
25b it5			
hAnd5h	nonE		
Protoc	HCp		
bt-5	bt5Et	on, oFF Bluetooth on / off	
	btnANE	Device name displayed in the Bluetooth network	

Print Data output	intFcE		rS232	RS 232 interface			
			usb-d	USB-Schnittstelle			
	sum		on	Switch on / off add-up mode, see chap. 15.5.1			
			off				
	PrNode	trig	MANUAL	on, off Data output by pressing the PRINT button, see chap. 15.5.2			
			AutoPr	on, off Automatic data output with stable and positive weighing value see chap.15.5.3. Another output only af- ter zero display and stabilisation, de- pending on the settings < ZRANGE >, selectable (off, 1, 2, 3,4,5). < ZRANGE > defines the factor for d. This factor multiplied with d results in the threshold; when it is exceeded, a value cannot more be con- sidered as stable.			
		cont	off	Continuous data output			
				SPEED	Setting output interval see chap. 15.5.4		
				ZERO	on, off 0 (unloaded) also transmit continuously		
		WEIGHT	SGLPrE		on, off		Displayed weight value is transmitted
			GntPrE	Gross		on, off	
				net		on, off	
				tARE		on, off	
				FORmAt		LONG (detailed measu- rement protocol) SHORT (standard mea- surement protocol)	
	LAYout	none		on, off Standard layout			
		user	Model		on, off Output model designation of the scale		
			Serial		on, off Output serial number of the scale		
rESEt		Delete settings					

bEEPEr Acoustic signal	REYb	oFF	Switch on / off acoustic signal by pressing button		
		on			
	chEcH	ch-on	oFF	Acoustic signal off	
			bLoB	Slow	
			bEd	Standard	
			FASt	Fast	
			cont.	Continuous	
		ch-Lo	oFF	Acoustic signal off	
			bLoB	Slow	
			bEd	Standard	
			FASt	Fast	
			cont.	Continuous	
		ch-hi	oFF	Acoustic signal off	
			bLoB	Slow	
	bEd		Standard		
FASt	Fast				
cont.	Continuous				
AutoFF Automatic switch-off function in rechargeable battery operation	Node	oFF	Automatic switch-off function switched off		
		Auto	The balance is automatically switched-off according to the time without load change or without operation defined in menu item < t .nE >		
		onLY0	Automatic switch-off only with zero display		
	t .nE	30b	After the set time without load change or operation the balance will switch off automatically		
		1n in			
		2n in			
		5n in			
		30n in			
			60n in		

ቢረ ገሰኔ Display background illumination	በሰደ	ALWAYS	Background lighting of display is switched on permanently
		ቴ ገሰሮ	The background illumination is automatically switched-off according to the time without load change or without operation defined in menu item < ቴ ገሰሮ >
		noBL	Display background illumination always switched off
	ቴ ገሰሮ	5ኔ	Definition, after which time the background illumination is automatically switched-off without load change or without operation.
		10ኔ	
		30ኔ	
		1ገ ገ	
2ገ ገ			
5ገ ገ			
OFF	i	In the event that small quantities are removed or added to the material to be weighed, incorrect weighing results can be displayed due to the “stability compensation”. (e.g. slow flow of liquids from a container placed on the balance, evaporating processes). When apportioning involves small variations of weight, it is advisable to switch off this function.	
	ON, OFF	Using this function you can define which weighing units are available in the application-specific menu < ህገ ሰረ >. The units selected by < ሰገ > are available in the application-specific menu.	
ህገ ሰረ Units	available weighing units / application units, see chap. 1	ON, OFF	
በሰደ Weighing applications	ሄሮ ገ	Weighing	
	count	Counting	
	check	Check weighing	
ሩሮሮ	Reset balance settings to factory settings		

15 Interfaces

The balance can communicate with external peripherals using the interface. Data can be sent to a printer, PC or control displays. In the same way, control commands and data inputs may occur via the connected devices (such as PC, keyboard, barcode reader).

15.1 RS-232C interface

The balance is equipped as per standard with an RS232C interface to connect a peripheral device (e.g. printer or computer).

15.1.1 Technical data

Connection	9 pin d-subminiature bushing
Baud rate	1200/2400/4800/9600/19200 optional
Parity	Empty / Odd number / Even number

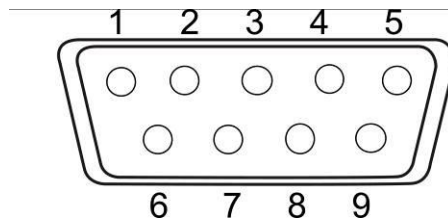

15.1.2 Interface cable

Balance	2	—————	3	PC
9-poles	3	—————	2	9-poles
	5	—————	5	
Balance	2	—————	3	Printer
9-poles	3	—————	2	9-poles
	5	—————	5	

15.1.3 Connect printer

- ⇒ Turn off scale and printer.
- ⇒ Use a suitable cable to connect the weighing balance to the interface of the printer.
Faultless operation requires an adequate KERN interface cable (optional).
- ⇒ Turn on scale and printer.

i Communication parameters (baud rate, bits and parity) of balance and printer must match; see menu item < 000 → 15232. >. (chap. 14.3.1)

15.2 USB connection

The scale is equipped as standard with a USB interface for connecting a peripheral device (e.g. computer).

Note:

This interface is not suitable for connecting a printer.

15.2.1 Connect PC

Switch off the scale and connect it to the PC as shown in the illustration.

Switch on the scale.

The USB driver is installed automatically.

If necessary, a suitable driver can be downloaded from our KERN homepage

www.kern-sohn.com/Downloads. Select the driver version suitable for your system and execute the exe file.

To transfer the data into a PC programme we recommend our transfer software "Balance Connection KERN SCD 4.0".

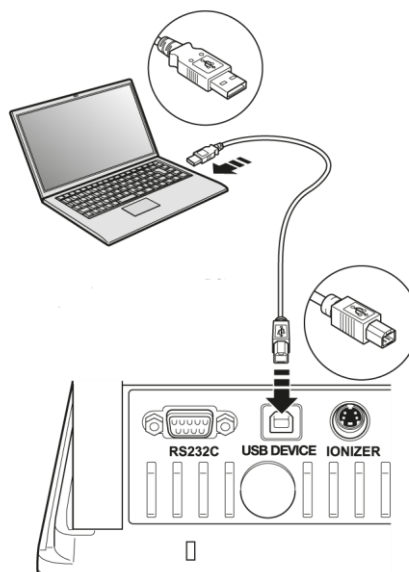

Printout examples:

Net weight:

S S 17.2 g

Tare weight:

543.8 g

Gross weight:

561.0 g

15.3 Bluetooth (Factory option)

Legal notices

Bluetooth® is a registered and protected trademark of Bluetooth® SIG, Inc.

The wordmark and logos are the property of Bluetooth® SIG, Inc.

The use of such trademarks is licensed by KERN. Other trademarks and brand names are the property of their respective owners.

15.3.1 Add device

⇒ Switch on balance

⇒ Enable Bluetooth and click the Bluetooth icon  on the task bar.

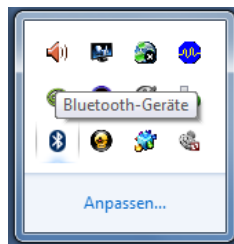

⇒ Click on „Add device“.

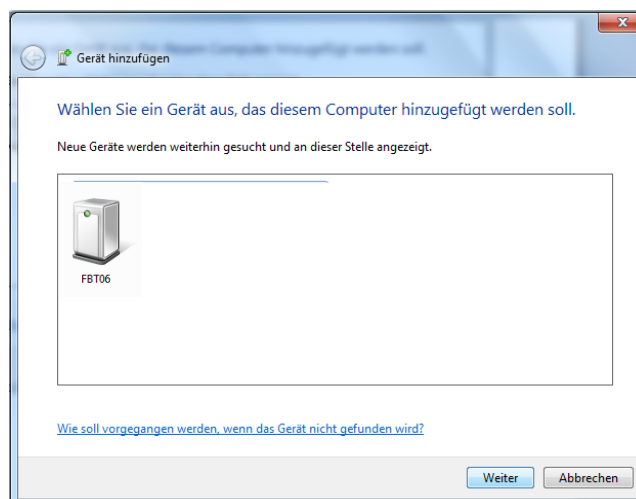
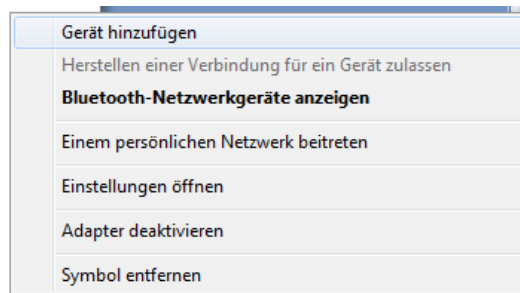

⇒ Mark “BT2.1SPP“ or „BLE4.0“ and click “Next“

⇒ Click on "Enter pairing code of the device"

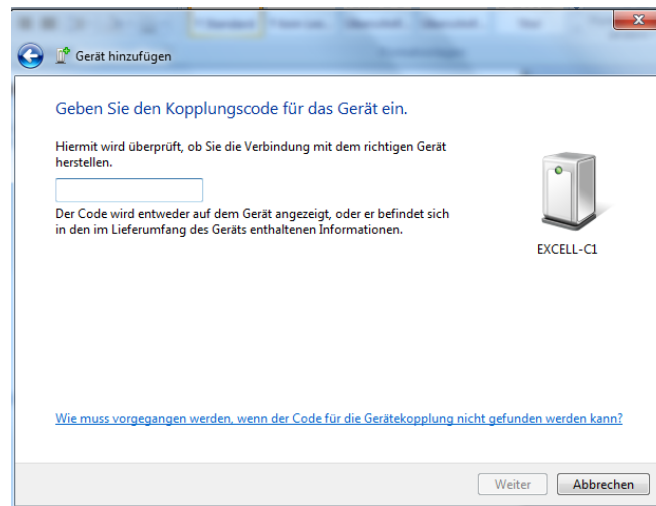
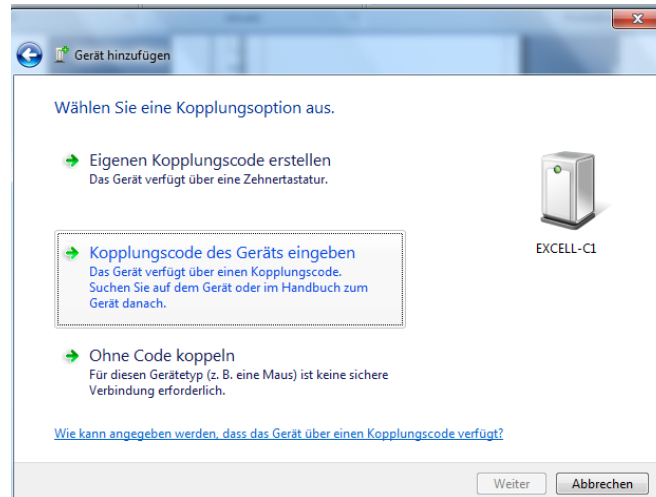

⇒ Enter code 1234



⇒ Click on „Close“

15.3.2 Determine COM Port number

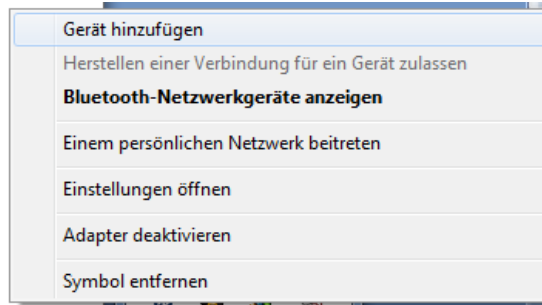

⇒ Display Bluetooth network appliances

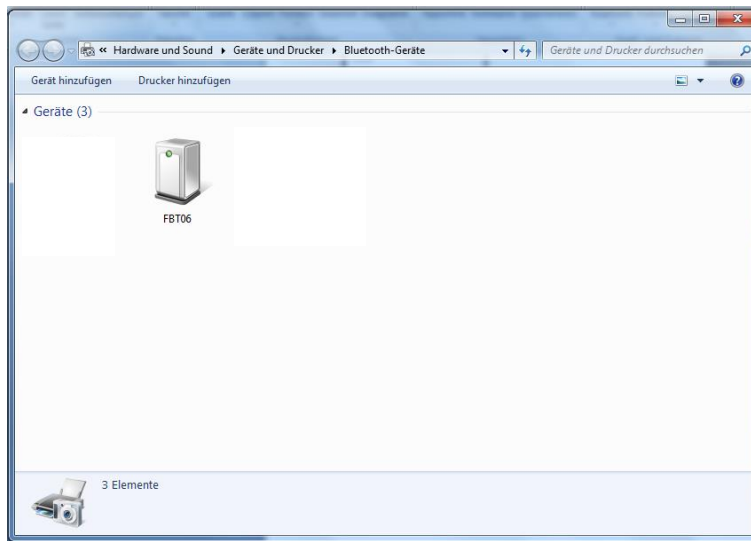

⇒ Double-click to display the COM Port

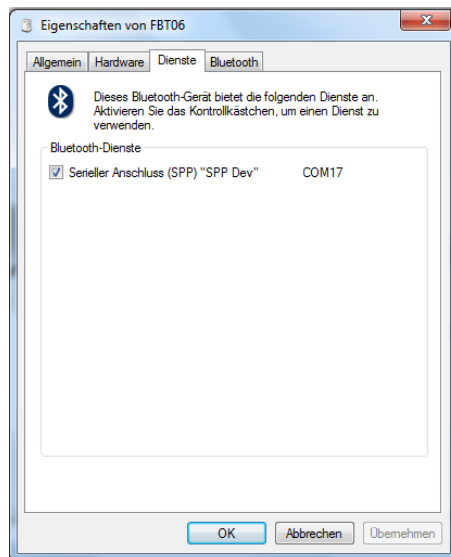

15.4 KERN Communications Protocol (KERN Interface Protocol)

KCP is a standardized set of interface orders for KERN balances, which allows many parameters and device functions to be called up and controlled. KERN devices that have KCP can use it to connect easily to computers, industrial control systems and other digital systems. A detailed description you will find in the „KERN Communications Protocol“ manual, available in the download area on our KERN homepage (www.kern-sohn.com).

To activate KCP please observe the menu overview of your balance’s operating instructions.

KCP is based on simple ASCII orders and replies. Every interaction consists of an order, possibly with arguments separated by spaces and finished by <CR><LF>.

The KCP orders supported by your balance may be queried emitting the order „I0“ followed by CR LF.

Extract of the mostly used KCP orders:

I0	Shows all implemented KCP orders
S	Sending stable value
SI	Sending current value (also instable)
SIR	Sending current value (also instable) and repeating
T	Taring
Z	Zeroing

Example:

Order	S	
Possible replies	S_ S_100.00_ g S_! S_+ or S_-	Order accepted, execution of the order started, currently another order is executed, timeout reached, over- or underload

15.5 Issue functions

15.5.1 Add-up mode < 500 >

With this function the individual weighing values are added into the summation memory by pressing a button and edited when an optional printer is connected.

Activate function:

- ⇒ In Setup menu invoke the menu setting < Pr iNt > → < 500 > and confirm with button [↵].
- ⇒ Use the navigation keys ↓↑ to select the setting < 00 > and confirm on [↵] button.
- ⇒ To exit the menu, press the navigation key ← repeatedly



Condition: Menu setting

< Pr iNt > → < t r iG > → < NAtURAL > → < 00 >

Add-up weighed goods:

- ⇒ If required, place empty container on scale and tare.
- ⇒ Place first good to be weighed on balance. Wait until stability display (▲▲) appears and then press the PRINT-button. The display changes to < 500 1 >, followed by the current weighing value. The weighing value is stored and edited by the printer. The symbol Σ pops up. Remove the weighed good.
- ⇒ Place second good to be weighed on balance. Wait until stability display (▲▲) appears and then press the PRINT-button. The display changes to < 500 2 >, followed by the current weighing value. The weighing value is stored and edited by the printer. Remove the weighed good.
- ⇒ Add-up more weighed goods as described above.
- ⇒ You can repeat this process until the capacity of the scales is exhausted.

Display and edit sum „Total“:

- ⇒ Press the PRINT key long time. The number of weighings and the total weight are edited.
The sum memory is deleted; the symbol [.Σ.] extinguishes.

Sample log (KERN YKB-01N):

Menu setting < PrNode > → < ForNAt > → < Short >

No.			1		First weighing
N:	S S	1.9993 kg			
T:		0.0000 kg			
G:		1.9993 kg			
C:		1.9993 kg			
No.			2		Second weighing
N:	S S	0.9992 kg			
T:		0.0000 kg			
G:		0.9992 kg			
C:		2.9985 kg			
No.			3		Third weighing
N:	S S	0.4992 kg			
T:		0.0000 kg			
G:		0.4992 kg			
C:		3.4977 kg			
No.			3		Number of weighings/ Total
C:		3.4977 kg			

Sample log (KERN YKB-01N):

Menu setting

< PrNode > → < BE iGht > → < SCLPrt > → < on >

No.			1		First weighing
C:	200.0 g				
No.		200.0 g	2		Second weighing
C:	500.0 g				
No.		700.0 g	3		Third weighing
C:	400.0 g				
No.		1100.0 g	4		Fourth weighing
C:	100.4 g				
No.		1200.4 g	4		Number of weighings/ Total
C:		1200.4 g			

15.5.2 Data output after pressing the PRINT button < ПРІНТ >

Activate function:

- ⇒ In Setup menu invoke the menu setting < Print > → < Print Mode > → < Print > and confirm with [↵] button.
- ⇒ For a manual data output select the menu setting < ПРІНТ > with the navigation keys ↓↑ and confirm on the [↵] button.
- ⇒ Use the navigation keys ↓↑ to select the setting < ON > and confirm on [↵] button.
- ⇒ To exit the menu, press the navigation key ← repeatedly.

Place goods to be weighed on balance:

- ⇒ If required, place empty container on scale and tare.
- ⇒ Place goods to be weighed. The weighing value is edited by pressing the PRINT-button.

15.5.3 Automatic data output < ȦȦȦ >

Data output happens automatically without having to press the **PRINT** button as soon as the corresponding output condition has been met, dependent on the setting in the menu.

Enable function and set the output condition:

- ⇒ In Setup menu invoke the menu setting < ȦȦȦ > → < ȦȦȦȦȦȦ > → < ȦȦȦȦȦȦ > and confirm with [↵] button.
- ⇒ For an automatic data output select the menu setting < ȦȦȦ > using the navigation keys ↓↑ and confirm by the [↵] button.
- ⇒ Use the navigation keys ↓↑ to select the setting < ȦȦȦ > and confirm on [↵] button. < ȦȦȦȦȦȦ > is displayed.
- ⇒ Acknowledge by [↵] button and set the required output condition with the navigation keys ↓↑.
- ⇒ Acknowledge by [↵] button.
- ⇒ To exit the menu press the navigation key ← repeatedly.

Place goods to be weighed on balance:

- ⇒ If required, place empty container on scale and tare.
- ⇒ Place weighed goods and wait until the stability display (▲▲) appears. The weighing value is issued automatically.

15.5.4 Continuous data output < ȦȦȦȦȦȦ >

Enable function and set the output interval:

- ⇒ In Setup menu invoke the menu setting < ȦȦȦ > → < ȦȦȦȦȦȦ > → < ȦȦȦȦȦȦ > and confirm with [↵] button.
- ⇒ For a continuous data output select the menu setting < ȦȦȦȦȦȦ > using the navigation keys ↓↑ and confirm on [↵] button.
- ⇒ Use the navigation keys ↓↑ to select the setting < ȦȦȦȦȦȦ > and confirm on [↵] button.
- ⇒ < ȦȦȦȦȦȦ > is displayed.
- ⇒ Acknowledge with the [↵] button and set the required time interval with the navigation keys ↓↑ (numerical input see chap. 3.2.2)
- ⇒ Set the required output condition < ȦȦȦȦȦȦ > & < ȦȦȦȦȦȦ >.
- ⇒ To exit the menu press the navigation key ← repeatedly.

Place goods to be weighed on balance

- ⇒ If required, place empty container on scale and tare.
- ⇒ Place goods to be weighed.
- ⇒ The weighing values are issued according to the defined interval.

Sample log (KERN YKB-01N):

S D	1.9997	kg
S D	1.9999	kg
S D	1.9999	kg
S D	1.9999	kg
S S	2.0000	kg
S S	2.0000	kg
S S	2.0000	kg
S S	2.0000	kg
S D	1.9998	kg
S D	1.9998	kg
S D	2.0002	kg
S D	2.4189	kg
S D	2.9999	kg
S D	2.9996	kg
S D	2.9996	kg
S D	2.9997	kg
S D	2.9997	kg
S S	2.9996	kg
S S	2.9996	kg

15.6 Data format

- ⇒ In the setup menu call up the menu setting <Print> → <PrintMode> → <BEight> → <PrintPrt> and confirm on [↵] button.
- ⇒ Use the navigation keys ↓↑ to select the menu setting <Format> and confirm on [↵] button.
- ⇒ Use the navigation buttons ↓↑ to select the desired setting.
Options:
 - <Short> Standard measuring protocol
 - <Long> Detailed measuring protocol
- ⇒ Confirm setting with [↵] button.
- ⇒ To exit the menu press the navigation key ← repeatedly.

Sample log (KERN YKB-01N):

Format → Short			Format → Long		
N:	S S	2.0000 kg	N:	S D	2.0000 kg
T:		0.5000 kg	Tara weight after x:		0.5000 kg
G:		2.5000 kg	Gross weight:		2.5000 kg

16 Servicing, maintenance, disposal



Before any maintenance, cleaning and repair work disconnect the appliance from the operating voltage.

16.1 Cleaning

Please do not use aggressive cleaning agents (solvents or similar agents), but a cloth dampened with mild soap suds. Ensure that no liquid penetrates into the device. Polish with a dry soft cloth.

Loose residue sample/powder can be removed carefully with a brush or manual vacuum cleaner.

Spilled weighing goods must be removed immediately.

16.2 Servicing, maintenance

- ⇒ The appliance may only be opened by trained service technicians who are authorized by KERN.
- ⇒ Before opening, disconnect from power supply.

16.3 Disposal

Disposal of packaging and appliance must be carried out by operator according to valid national or regional law of the location where the appliance is used.

17 Instant help for troubleshooting

In case of an error in the program process, briefly turn off the balance and disconnect from power supply. The weighing process must then be restarted from the beginning.

Fault	Possible cause
The weight display does not glow.	<ul style="list-style-type: none">• The balance is not switched on.• The mains supply connection has been interrupted (mains cable not plugged in/faulty).• Power supply interrupted.
The displayed weight is permanently changing	<ul style="list-style-type: none">• Draught/air movement• Table/floor vibrations• Weighing plate has contact with foreign objects.• Electromagnetic fields / static charging (choose different location/switch off interfering device if possible)
The weighing result is obviously incorrect	<ul style="list-style-type: none">• The display of the balance is not at zero• Adjustment is no longer correct.• The balance is on an uneven surface.• Great fluctuations in temperature.• Warm-up time was ignored.• Electromagnetic fields / static charging (choose different location/switch off interfering device if possible)

18 Error messages

Error message	Explication
0L n t	Zero setting range exceeded
undEr0	Zero setting range not achieved
instAb	Load instable
ErOnG	Adjustment error
L---	Underload
----	Overload
Lo bAt	Capacity of batteries / rechargeable batteries exhausted