



Technical Specifications

MOBOTIX MOVE 2MP Low-Light Video Analytics Speed Dome

Supported by high-performance DNN processor/SoC in combination with state-of-the-art CMOS video sensor, the outdoor MOBOTIX MOVE 2MP Low-Light Video Analytics Speed Dome is much more than just standard, providing crisp, noise-free and smooth video streaming at full HD 2MP resolution even under extreme low-light conditions. The integrated DNN-based video analytics functions include face and license plate recognition that can be combined with preset PTZ positions to enable a wide variety of 24/7 video surveillance applications. The MOBOTIX EverClear superhydrophilic and self-cleaning nano coating of the dome ensures best image quality even in rain and reduces cleaning efforts and operational costs.

- High light sensitivity: 0.01 Lux color, 0.001 Lux B/W
- 30x motorized zoom/focus lens 4.3 to 129 mm
- WDR up to 130 dB
- Quad streaming H.264/H.265/MJPEG
- Intelligent encoding, smart low-bitrate control
- MOBOTIX MxMessageSystem
- 2D & 3D motion-compensated noise reduction (MCTF)
- ONVIF Profile S/G/T/M support
- Electrical image stabilizer (EIS)
- Auto object tracking, DNN-based (persons, vehicles)
- DNN video analytics (8 VA, Face & ALPR) linkable to PTZ presets & smart event functions
- Smart Event Functions
- Micro SD/SDHC/SDXC card support up to 1 TB
- Dual power support (IEEE802.3at/AC24V)
- Outdoor protection rate IP66, IK10
- Temp. Range -40 to 55 °C/-40 to 131 °F with heater
- EverClear coating of dome



Technical Specifications

MOBOTIX MOVE 2MP Low-Light Video Analytics Speed Dome

High-Quality DNN Edge Video Analytics



The latest computer vision technology makes the DNN-accelerated video processing engine efficient at the edge. This integrated engine provides high accuracy, real-time object tracking and 10 (DNN-based) video analytics functions including ALPR and human face recognition. Moreover, it allows simultaneous detection on multiple objects.

MOBOTIX EverClear Nano Coating

The new, groundbreaking MOBOTIX EverClear coating uses a special nano technology that transforms water droplets into an ultra-thin water film immediately upon impact. This ensures the highest image quality in rain and difficult environmental conditions and reduces maintenance costs due to its “self-cleaning” effect.



Product Information

Product Name	2MP Low-Light Video Analytics Speed Dome
Order Code	Mx-SD2A-230-LL-VA

Image Quality

Image Sensor	2MP 1/2.8” Progressive CMOS IMX662 (SONY STARVIS II)
Effective (Used) Pixels	H x V = 1920x1080 (2MP)

Technical Specifications

MOBOTIX MOVE 2MP Low-Light Video Analytics Speed Dome

Pixel Size	2.9 μm
Frame Rate (maximum)	WDR on/off: H.265/H.264: 2MP@30 fps MJPEG: 1080p@30 fps
Dome Coating	Superhydrophilic MOBOTIX EverClear nano coating transforms water droplets into an ultra-thin water film upon impact. The coating ensures best image quality in rain and difficult external conditions and it reduces reflections and noise in low-light scenarios. EverClear is dirt-repellent and increases the stability as well as the scratch-resistance of the dome, further reducing maintenance efforts. Coating endurance up to 3 years depending on environmental conditions and cleaning treatment.

Hardware Design

Processor	Ambarella CV25
Memory	RAM: 8 GB, FLASH: 4 GB

Lens

Minimum Illumination	Color: 0.01 Lux B/W: 0.001 Lux F1.6, AGC=on, 30 IRE, 1/1 s
Lens Characteristics	Zoom Lens: Zoom, Auto Focus, P-IRIS, Auto-IRIS Focal Length: 4.3 to 129 mm Aperture: F1.6 – F4.7 Horizontal Field of View: 59.3° (Wide), 2.3° (Tele) Vertical Field of View: 34.9° (Wide), 1.4° (Tele)

Technical Specifications

MOBOTIX MOVE 2MP Low-Light Video Analytics Speed Dome

Camera

Shutter Speed (Auto)	1 to 1/10000 s
Shutter Speed (Manual)	WDR: 1/37500 s Linear: 1/75000 s
Shutter Priority Mode	Up to 1/45 s
WDR	Up to 130 dB
Electronic Image Stabilizer (EIS)	Yes
Auto Object Tracking	On/off (object-based DNN algorithm: humans/vehicles selectable)
Zoom	Optical: 30x, Digital: 10x
Image Settings	Color, Brightness, Sharpness, Contrast, White Balance, Exposure Control, 2DNR, 3DNR, NR by Motion, Masking, Text Overlay
Image Rotation	90°, 180°, 270°
Servo Feedback	Yes

PTZ Features

Preset positions	Up to 256 positions, 1 Home position
Sequences	Up to 8 sequences with 64 preset positions each
Cruise Paths	Up to 8
Auto Pan Paths	Up to 4
Display Position	Pan/Tilt degrees can be displayed in live image
Pan Range	360° endless
Tilt Range	-10° to +100°
Pan Speed	Manual Pan Speed: 0.1°-90°/s Preset Pan Speed: 400°/s
Tilt Speed	Manual Tilt Speed: 0.1°-55°/s Preset Tilt Speed: 300°/s
Joystick/Keypoint Control	RS485 protocols DSCP, Pelco-D and Pelco-P
Video Analytics	Presets can be combined with 1 selectable integrated video analytics feature

Video Codec

Compression/Encoding	H.265/H.264/MJPEG
Streaming	Up to 9 individually configurable streams (4 streams, 4 sub streams, 1 Quad stream) in H.264/H.265/MJPEG; configurable resolution, frame rate, bandwidth LBR/VBR/CBR in H.265/H.264

Audio Codec

Compression/Encoding	G.711/G.726/AAC/LPCM
Streaming	Bi-directional
Audio Input	Line In Max. 2.28 V _{pp} for line signal Input impedance: 33 kΩ
Audio Output	Line Out Output resistance: 220 Ω Output voltage: 1 V _{rms}

Cyber Security Features

Password Protection	Yes (including “forced” password change during initial setup)
IP address filtering	Yes
IEEE 802.1X network access control	Yes
Digest authentication	Yes
AES encryption for password protection	Yes
SNMP, TLS, HTTP, HTTPS	Yes
User and Group Management	Yes
SSL connections	Yes
VPN	Yes

Technical Specifications

MOBOTIX MOVE 2MP Low-Light Video Analytics Speed Dome

Digital image signature Yes

RSA encryption (2048 bits) Yes

Network

Interface 10/100 Mbps Ethernet

Supported Protocols ARP, PPPoE, IPv4/v6, ICMP, IGMP, QoS, TCP, UDP, DHCP, UPnP, SNMP, SMTP, RTP, RTSP, HTTP, HTTPS, FTP, NTP, DDNS, SMBv2, VPN

ONVIF conformance Supports profiles S/G/T/M

Supported Browsers All current browsers (e.g. Microsoft Edge, Firefox, Google Chrome, Opera, etc.) are supported.

System Integration

Base Video Analytics

- Motion detection
- Audio detection

Enhanced Video Analytics
(linkable to PTZ presets)

- Abandoned objects
- Intrusion (object classification)
- Sabotage
- Wrong direction
- Loitering (object classification)
- Object counting (object classification)
- Object removal
- Stopped vehicle (object classification)

2 analytics functions can be activated simultaneously

MOBOTIX MOVE 2MP Low-Light Video Analytics Speed Dome

<p>DNN (Deep Neural Network) based video analytics (linkable to PTZ presets)</p>	<ul style="list-style-type: none"> ▪ Face Recognition (incl. gender & age estimation) ▪ Number Plate Recognition – supported countries: Armenia, Austria, Azerbaijan, Belarus, Belgium, Bosnia and Herzegovina, Bulgaria, Croatia, Cyprus, Czech Republic, Denmark, Estonia, Finland, France, Georgia, Germany, Greece, Hungary, Ireland, Israel, Italy, Japan, Kazakhstan, Kyrgyzstan, Latvia, Lithuania, Luxembourg, Moldova, Monaco, Montenegro, Netherlands, North Macedonia, Norway, Poland, Portugal, Romania, Russia, Serbia, Slovakia, Slovenia, Spain, Sweden, Switzerland, Taiwan, Turkey, Ukraine, United Kingdom, Uzbekistan, Vietnam
--	---

<p>Event Triggers</p>	<ul style="list-style-type: none"> ▪ External input ▪ Analytics ▪ Network failure detection ▪ Periodical event ▪ Manual trigger ▪ MxMessageSystem messages
-----------------------	--

<p>Event Actions</p>	<ul style="list-style-type: none"> ▪ External output activation ▪ Video and audio recording to edge storage ▪ File upload: FTP, network share and email ▪ Notification: HTTP, FTP, email ▪ MxMessageSystem messages
----------------------	--

General

<p>Housing material</p>	<p>Metal and plastic</p>
<p>Power Requirements</p>	<p>PoE+ IEEE802.3at, class 4, max 25.5 watt AC24V, max 29.04 watt, max 53.24 VA</p>
<p>PoE Modes Supported</p>	<p>Mode A or Mode B</p>

Technical Specifications

MOBOTIX MOVE 2MP Low-Light Video Analytics Speed Dome

Connectors	<ul style="list-style-type: none">▪ RJ45▪ 4 x Alarm in, 2x Alarm out, Audio in, Audio out, RS485 terminal block▪ AC24V terminal block▪ CVBS connector (available with max. 2 activated streams)
------------	--

Video Storage	Micro SD/SDHC/SDXC card support up to 1 TB (using SD card adapter), Support for recording to NAS, MOBOTIX HUB, MOBOTIX MOVE NVR
---------------	--

Remotely Upgradable	Yes
---------------------	-----

Environmental Protection Class	IP66/IK10
--------------------------------	-----------

Operating Temperature	-40 to 55 °C/-40 to 131 °F with heater
-----------------------	--

Relative Humidity	10 to 90 % non-condensing
-------------------	---------------------------

Storage Conditions	-20 to 70 °C/-4 to 158 °F
--------------------	---------------------------

Approvals	EMC: CE/FCC Safety: LVD
-----------	----------------------------

MTBF	50,000 hours
------	--------------

Warranty	5 years; mechanically wearable parts (motor, gears, belts, etc.) excluded
----------	---

Dimensions	ø 210 x 294.5 mm
------------	------------------

Weight	3100 g
--------	--------

NOTE! Observe the [MOBOTIX MOVE Installation Hints](#) document to ensure optimum performance of the camera features.

Alarm Input/Output Current and Voltage

Alarm In

5 V with 10 kΩ pull up, 50 mA

Alarm Out

400 V DC/AC, 120 mA









DORI Specifications

In the video surveillance context, “DORI” stands for Detection, Observation, Recognition and Identification and is based on IEC EN62676-4: 2015. These levels define the minimum pixels that a face of a person must have to provide proper identification, for example.



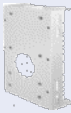

- **Detection:** Up to this distance, you can reliably determine if a person or vehicle is present.
- **Observation:** Up to this distance, you can see characteristic details of an individual, such as distinctive clothing.
- **Recognition:** Up to this distance, you can determine with a high degree of certainty whether an individual is the same as someone that has been seen before.
- **Identification:** Up to this distance, you can determine the identity of an individual beyond reasonable doubt.

DORI Level	Detection		Observation		Recognition		Identification	
	Wide	Tele	Wide	Tele	Wide	Tele	Wide	Tele
Mx-SD2A-230-LL-VA	71 m/ 233 ft	1768 m/ 5801 ft	28 m/ 92 ft	702 m/ 2303 ft	14 m/ 46 ft	354 m/ 1161 ft	7 m/ 23 ft	177 m/ 581 ft

Accessories

Picture	Order Code	Description
	Mx-A-SD-DBC-EC	Clear replacement dome with EverClear coating
	MX-A-SD-DBT-EC	Tinted replacement dome with EverClear coating
	Mx-M-SD-C	Corner Mount for MOBOTIX MOVE cameras (only in combination with Wall Mount Mx-M-SD-W/WM)
	Mx-M-SD-GN	Parapet Mount (Gooseneck) with integrated junction box for MOBOTIX MOVE cameras
	Mx-M-SD-P	Pole Mount for MOBOTIX MOVE cameras (only in combination with Wall Mount Mx-M-SD-W/WM)
	Mx-M-SD-PM	Pendant Mount Kit 25 cm for MOBOTIX MOVE cameras
	Mx-M-SD-PMEXT	Pendant mount extension 25 cm for use with Pendant Mount Kit Mx-M-SD-PM
	Mx-M-SD-W	Wall Mount for MOBOTIX MOVE cameras; can be combined with Pole Mount Mx-M-SD-P or Corner Mount Mx-M-SD-C

MOBOTIX MOVE 2MP Low-Light Video Analytics Speed Dome

Picture	Order Code	Description
	Mx-M-SD-WM	Wall Mount with room for optional junction box Mx-M-SD-WMJB for MOBOTIX MOVE cameras
	Mx-M-SD-WMJB	Wall Mount Junction Box for MOBOTIX MOVE cameras
	Mx-NPA-UPOE1A-60W	UPoE Network Power Injector 60 W
	Mx-A-ETP1A-2601-SET	Media Converter Set Ethernet (PoE+) – Twisted-Pair

Dimensions

NOTE! Download the drilling template from the section or on the MOBOTIX website: www.mobotix.com > [Support](#) > [Download Center](#) > [Marketing & Documentation](#) > [Drilling Templates](#).

CAUTION! Always print or copy the drilling template at 100% of the original size!

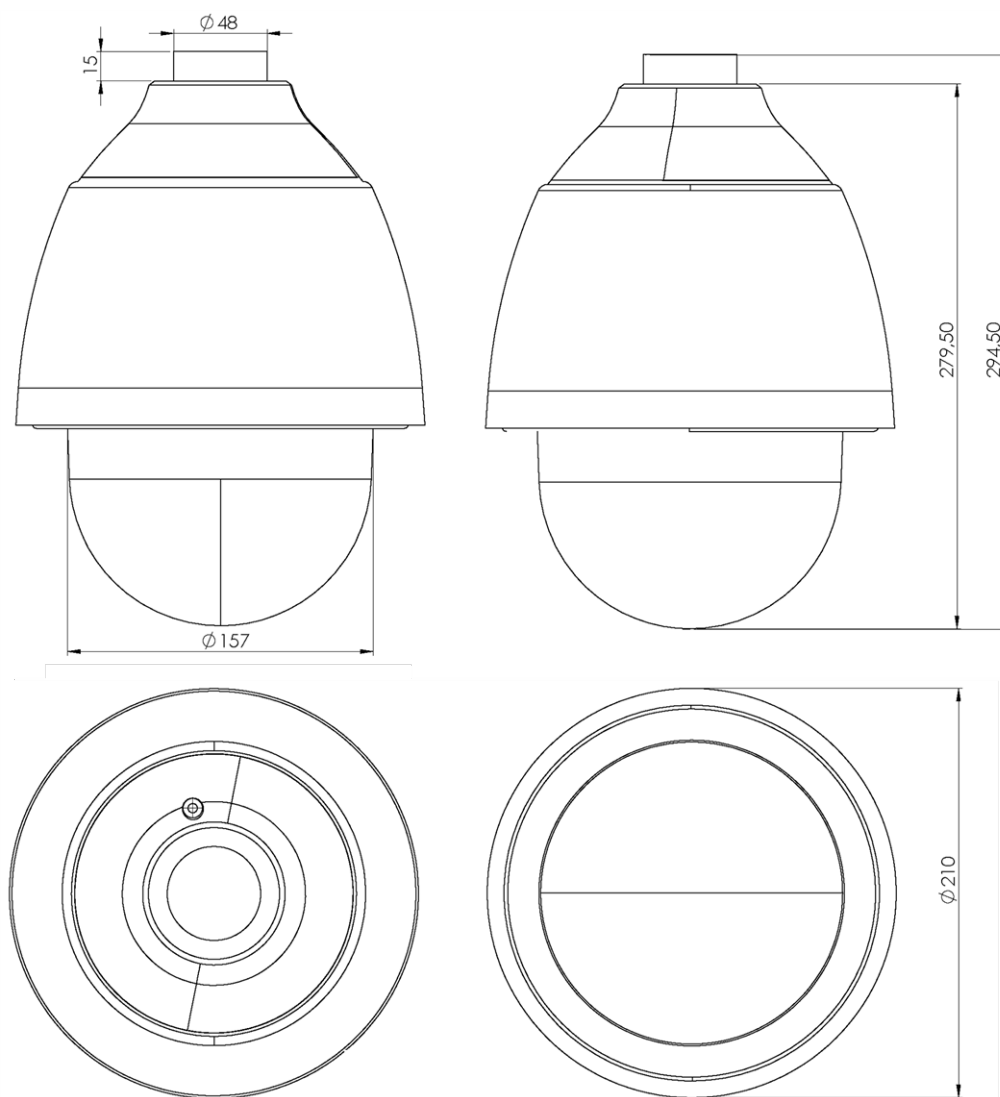

Fig. 1: 2MP Low-Light Video Analytics Speed Dome: All measurements in mm

Further Reading

[Manuals and Quick Installation documents](#)



[Video Analytics Manual](#)



[Technical Specifications](#)



[MOBOTIX MOVE Installation Hints](#)



MOBOTIX

BeyondHumanVision

EN_08/23

MOBOTIX AG • Kaiserstrasse • D-67722 Langmeil • Tel.: +49 6302 9816-103 • sales@mobotix.com • www.mobotix.com

MOBOTIX is a trademark of MOBOTIX AG registered in the European Union, the U.S.A., and in other countries. Subject to change without notice. MOBOTIX do not assume any liability for technical or editorial errors or omissions contained herein. All rights reserved. © MOBOTIX AG 2021