



USER MANUAL

Elo Touch Solutions
Elo Mobile Computer M50/M50C
Non-Payment

■ REVISION HISTORY

Revision	Eng.	Date	Description
Draft	Hector Amores	05/22/20	Draft.
A	Cameron Cole / Hector Amores / Bill Yu	12/21/2020	Initial release per CO-21-0196.

Copyright © 2021 Elo Touch Solutions, Inc. All Rights Reserved.

No part of this publication may be reproduced, transmitted, transcribed, stored in a retrieval system, or translated into any language or computer language, in any form or by any means, including, but not limited to, electronic, magnetic, optical, chemical, manual, or otherwise without prior written permission of Elo Touch Solutions, Inc.

Disclaimer

The information in this document is subject to change without notice. Elo Touch Solutions, Inc., and its Affiliates (collectively "Elo") makes no representations or warranties with respect to the contents herein, and specifically disclaims any implied warranties of merchantability or fitness for a particular purpose. Elo reserves the right to revise this publication and to make changes from time to time in the content hereof without obligation of Elo to notify any person of such revisions or changes.

Trademark Acknowledgments

Elo, Elo (logo), Elo Touch, Elo Touch Solutions, EloView, are trademarks of Elo and its Affiliates.

Contents

- Section 1: Introduction 10**
 - Product Description..... 11
 - Overview – Specifications..... 11
 - Features: Elo Mobile Computer M50/M50C..... 12

- Section 2: Getting Started 13**
 - Unpacking 14
 - Battery Installation 15
 - Battery Un-installation..... 16
 - Micro SD & Nano Sim Card Installation 17
 - Charging System & Power 18
 - Charging the Handheld computer through USB type C Port 18
 - Charging Safety Features:..... 18
 - Battery Status / Descriptions..... 18
 - Power Button..... 18
 - Power LED Status 18
 - Power / Function Buttons Features and Gestures 19
 - Power button On-Screen display menu features..... 19
 - Gestures..... 19
 - Status Bar Icons and Definition..... 20
 - About Touch Gestures 21
 - Out of Box Experience (OOBE)..... 22
 - Elo Hub Home Screen 23

Elo Hub Quick Settings	24
Lock and Home Screens.....	25
Android Notification Panel	26
Android™ Quick Aceso Panel	27
Android application Drawer & Google application.....	28
Customize and add a shortcut to the Home Screen.	29
Section 3: Android Settings	30
Network & Internet	31
Wi-Fi.....	31
Mobile Network	32
Airplane mode.....	33
Hotspot & tethering	33
Wi-Fi hotspot.....	33
USB tethering.....	33
Bluetooth tethering	33
Ethernet	34
Connected devices	35
Bluetooth	35
NFC	36
Cast.....	36
Print	37
USB	38
Apps & Notification	39

Battery.....	42
Battery Saver.....	42
Battery Manager	42
Battery percentage	42
Battery Usage	42
Display	44
Auto Idle mode	44
Brightness Level.....	44
Nigh Light Feature	44
Adaptive Brightness	45
Wallpaper.....	45
Advanced.....	45
Dark theme	45
Screen timeout.....	45
Auto-rotation screen.....	46
Font size	46
Display size	46
Screen saver	46
Screen Orientation.....	46
Lock screen display.....	47
Sound.....	48
Volumes.....	48
Do not Disturb	48
Prevent Ringing.....	49

Default Notification Sound	49
Default Alarm Sound.....	50
Screen locking Sound	50
Advanced.....	50
Storage	51
Internal Shared Storage.....	51
Storage Manager.....	51
SD card.....	51
Key Remap.....	52
Wakeup Source	52
Privacy	53
Permission Manger	53
Show passwords	53
Lock screen.....	53
Location	54
Security	55
Screen Lock	55
Swipe Security.....	55
Pattern Security	55
Pin Security	55
Password Security.....	56
Accounts	57
Accessibility	58

System.....	59
Languages & input.....	59
Gestures.....	59
Date & Time	61
Advanced.....	62
Reset options.....	62
Multiple users.....	62
To switch users.....	62
To add user	62
To delete guest from the device	63
To rename Admin Profile info	63
Developer	63
About Handheld.....	64
Section 4: Operational	65
About Camera App (Snapdragon).....	66
Camera Features	66
Video Features.....	68
Take a Picture and Record Video	70
Take a Screenshot	71
About Android File Application	71
Delete Files	71
Copy and Move Files	71
Share Files.....	72

About Imager Engine / Barcode Reader.....	73
A 610 nm LED is used to generate a circular aiming pattern which indicates the center of the imager's field of view.	73
Imager Aiming Element specifications.....	74
Imager Technical Specification.....	75
Imager Decode Ranges.....	76
User Preferences – Parameters	77
Imager Preferences – Parameters.....	78
Symbology Parameter.....	80
Barcode Scanning using Barcode Reader	84
Setting for User, Imaging and Symbology Parameters.....	85
Getting User, Imaging and Symbology Parameters.....	86
Scanning QR code with Integrated Camera.....	87
Reading NFC Tag	88
About Cellular Phone - (LTE/4G/3G) (M50C WWAN SKU only)	89
About Android Debug Bridge (ADB) control.....	90
About Elo Mobile Factory Full Reset	91
Section 5: Technical Support and Maintenance	92
Technical Assistance	92
Elo Mobile Computer Care and Handling.....	93
Section 6: Regulatory Information	94
Electrical Safety Information	94
Emissions and Immunity Information.....	94
Radio Equipment Directive.....	96
Agency Certifications	97

Waste Electrical & Electronic Equipment Directive (WEEE)..... 97

Section 7: Warranty Information..... 98

Section 1

Introduction

Product Description

Your new Elo Mobile computer combines the reliable performance from Elo with the latest developments in touchscreen technology and display design. This combination of features creates a natural flow of information between a user and the Handheld system.

Overview – Specifications

	M50 (Wi-Fi SKU)	M50C (WWAN SKU)
Operating System	Android 10	Android 10
Processor	Qualcomm SDA660	Qualcomm SDA660
Memory	4GB RAM	4GB RAM
Internal Storage	64GB NAND flash memory	64GB NAND flash memory
Display	5.5", 1280*720	5.5", 1280*720
Touch Screen	Capacitive touch, 2-touch minimum	Capacitive touch, 2-touch minimum
Rear Camera	8MP - 3264*2448, Auto Focus	8MP - 3264*2448, Auto Focus
Micro-SD + Nano SIM Card	Combination for Micro SD (up to 128GB) and SIM card	Combination for Micro SD (up to 128GB) and SIM card
Wi-Fi + Bluetooth	IEEE 802.11a/b/g/n/ac + Bluetooth 5.0 with BLE	IEEE 802.11a/b/g/n/ac + Bluetooth 5.0 with BLE
Cellular + GPS	NA	LTE/4G/3G + GPS/GLONASS/Galileo/BeiDou
Microphone	Sensitivity of -44dB (0dB=1V/Pa) min.	Sensitivity of -44dB (0dB=1V/Pa) min.
Speaker	1x 1W RMS MONO	1x 1W RMS MONO
Main Battery	Single cell, 3.8V/4000mAh minimum	Single cell, 3.8V/4000mAh minimum
USB Port	Type-C	Type-C
NFC	ISO 14443 Type A/B ISO 15693 ISO 18092 R/W MIFARE	ISO 14443 Type A/B ISO 15693 ISO 18092 R/W MIFARE
Barcode Scanner	1D / 2D Imager	1D / 2D Imager
Ambient Light Sensor	Up to 75k Lux	Up to 75k Lux
G-Sensor	+/- 15° Accuracy minimum	+/- 15° Accuracy minimum

Features: Elo Mobile Computer M50/M50C

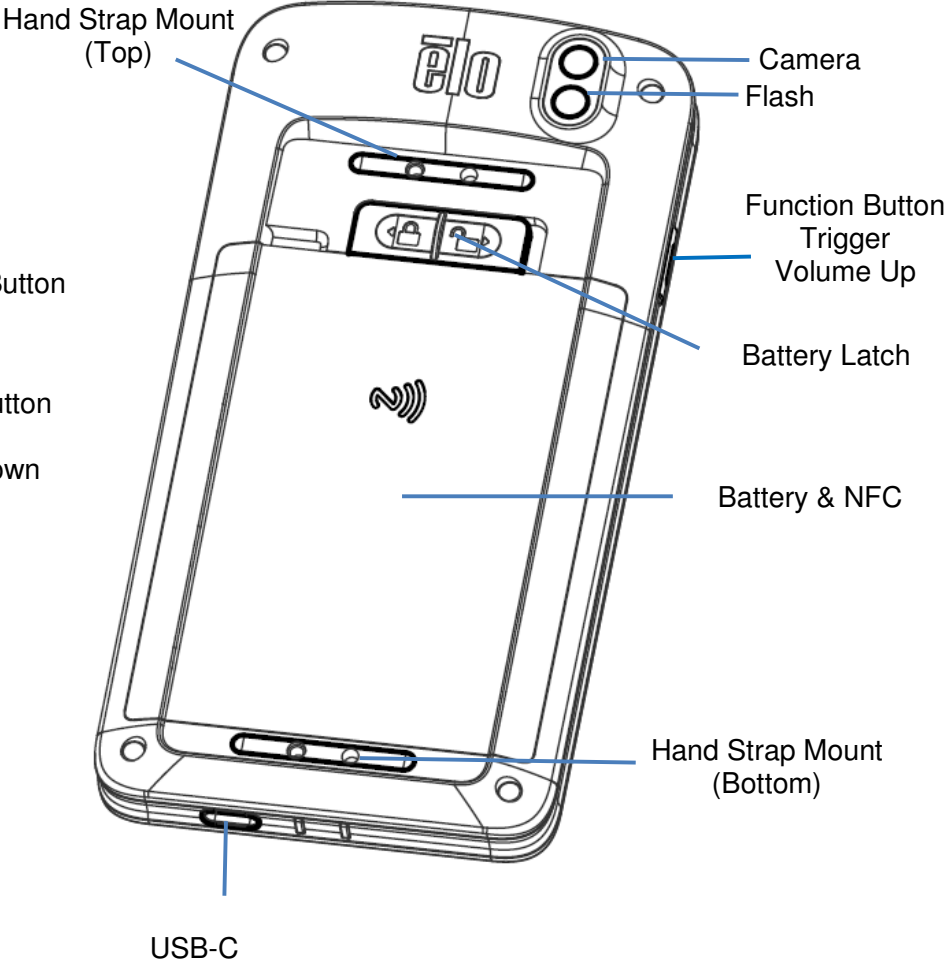
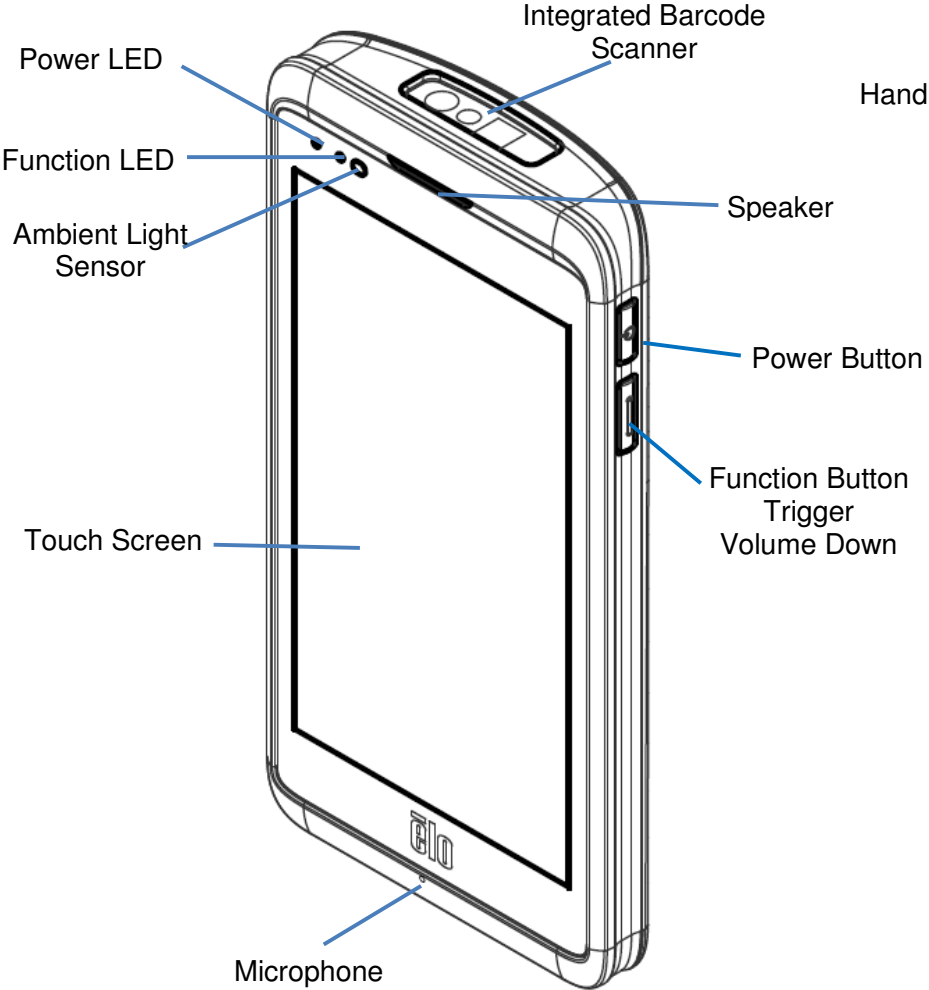

Section 2

Getting Started

Unpacking

Verify that the box contains:

- Elo Mobile Computer
- Charger (USB-C Type)
- Battery
- Quick Install Guide

Remove all protective material from the device.

Inspect the device for damage.

Report immediately if computer is damaged and with missing items as listed above.

Note: Before using the device for the first time fully charge the battery.

Battery Safety Precautions



The battery stores a large amount of energy in a small amount of space. Replace the battery with the same type only. Improper replacement of the battery may cause a risk of burns, fire, and explosions. Do not open, crush, bend, puncture, shred, heat above 60° C / 140° F or incinerate. Risk of fire and burns if improperly handled. Do not short circuit, immerse the battery in liquid, or attempt to insert any foreign object into the battery. Avoid storing under direct sunlight. If there is a serious swelling of the battery, do not continue using. Dispose of the battery according to local regulations.

Battery Information / Specification

- Rechargeable Li-ion Polymer Battery
- Nominal Voltage: 3.8Vdc
- Limited Charging Voltage: 4.35Vdc
- Maximum Charging Current: 4A
- Minimum Capacity: 4000mAh 15.2Wh

Battery Installation

- Insert the battery, start from the bottom first, then slide the battery down into the compartment then push.

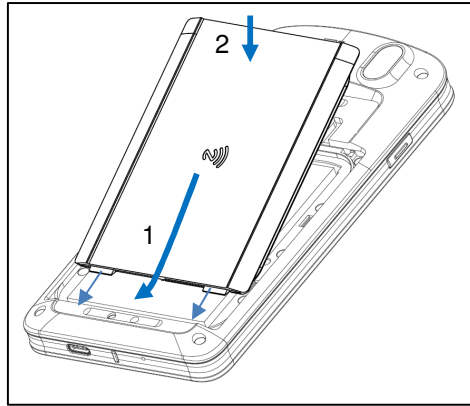

- While pressing down slide the battery lock to the left (into the locked position) to secure the battery.

Note: Press the upper left corner of battery cover tightly then latch the battery lock.

In order to protect the M50/M50C and maintain IP65 Ingres protection, check the battery after drops, or large impacts. Be sure the battery is secured properly, and no gaps are visible between the back cover and battery cover

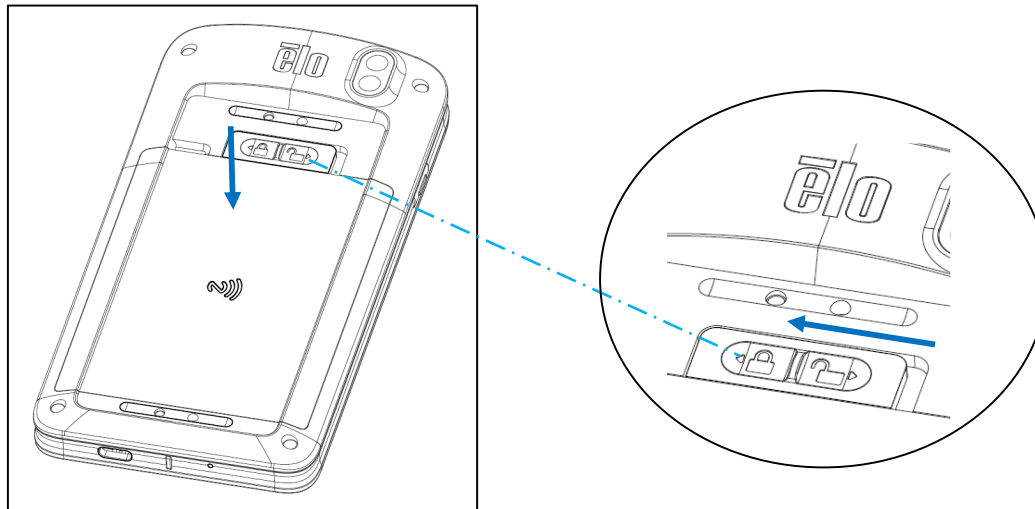

Battery Un-installation

- Shutdown the system. Refer on power status on this user manual for proper system shutdown.
- Remove the battery from the device.
- Slide the latch to the right to unlock the battery.

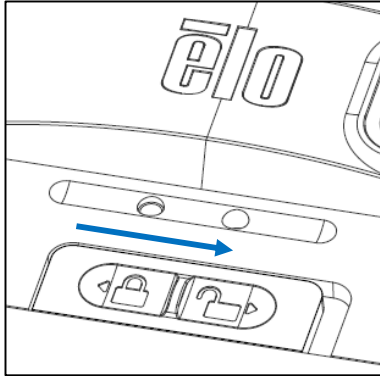

- Lift-up the battery, then slide up away from the compartment.

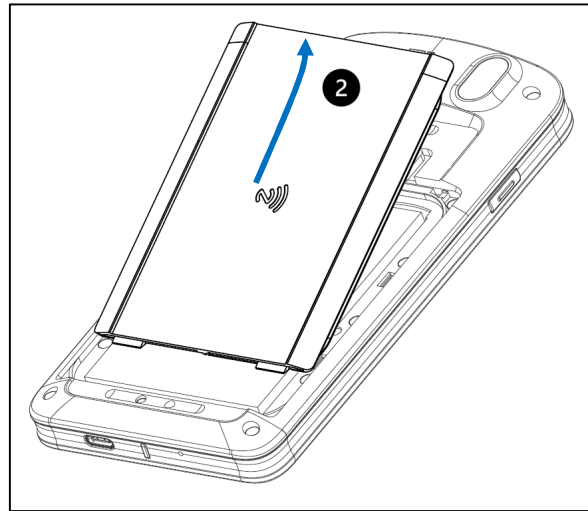
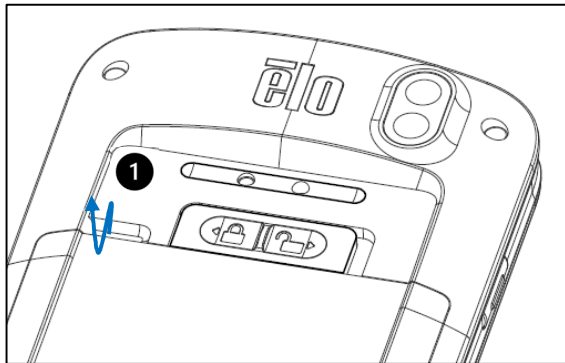

Micro SD & Nano Sim Card Installation

- First save files and shutdown the computer.
- Remove the battery. Refer on battery un-installation section of this user manual.
- Pull and slide down the Micro SD + Nano Sim carrier located on the upper right side of the battery compartment.

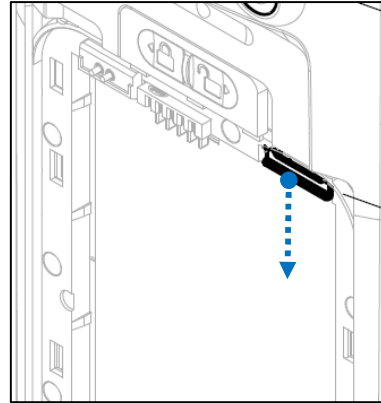

- Place the Micro SD and/or the Nano Sim card into the carrier with contact side face down.



- Insert the carrier back into the Micro SD card compartment.

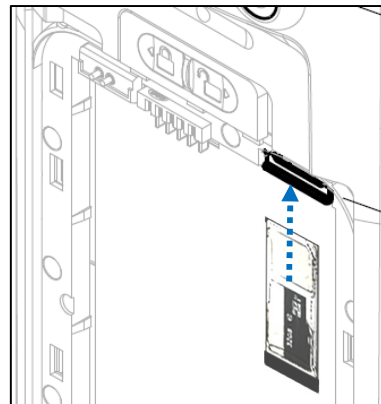

- Reinstall the battery. Refer on battery installation section of this user manual.

Charging System & Power

Charging the Handheld computer through USB type C Port







The Elo Mobile Computer is powered by a rechargeable battery (Li-ion polymer Battery). A charger (USB C type wall adapter) is included with the computer.

With Qualcomm Quick Charger 4.0 a charge to 90% will take about 60 – 90 minutes.

Charging Safety Features:

- Over charge/discharge protection
- Over current/short-circuit protection
- Temperature monitoring/Over temperature protection.
 - ❖ The handheld computer charger is design to stop charging when battery reaches the temperature of 43°C.

Battery Status / Descriptions

	Battery is charging		Battery is partially drained		Battery is very low at 15%
	Battery is full		Battery at 50%		Battery Saver is ON

Power Button

Note: If any reason the device does not display video while it is charging. Press the power button once and if battery icon  appears into the display screen it means it is in the OFF state.

- To turn ON the power of Elo Mobile Computer press and hold power button for 2 seconds.
- To Shut down or Restart, press and hold the power button for more than 5 seconds and follow the on-screen display menu.
- To force the system to Shutdown, press and hold the power button for 12 seconds.
- To bring the system out of sleep/standby mode, press the power button once or touch the screen.

Power LED Status

POWER LED STATUS	DESCRIPTION
OFF	OFF
Solid Green	Power ON, battery charging disabled
Solid Amber	Power ON, battery charging enabled

Power / Function Buttons Features and Gestures

Power button On-Screen display menu features

If the power button is pressed for more than 5 seconds, a pop-up screen menu will appear.

Android Home

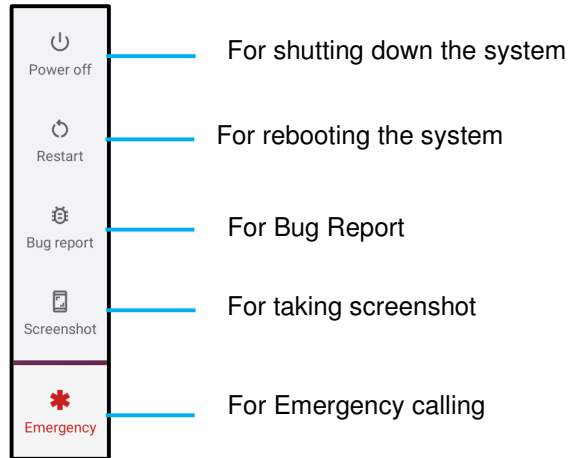

EloView

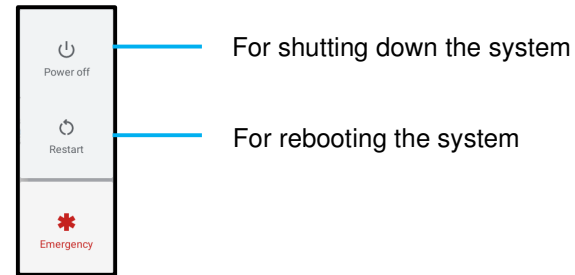





















































Gestures

Note: The following gesture will only work if the trigger buttons are set as “Volume up and down”. See [Key Remap](#) from Android Settings.

- Pressing power button twice will activate Camera.
 - ❖ To enable or disable this feature see *Android Settings on System* → *Gesture on this user manual*.
- Pressing power button + Volume Up will activate notification volume to vibrate or Mute depending on the settings.
 - ❖ To enable or disable this feature see *Android Settings on System* → *Gesture on this user manual*.
- Pressing power button + Volume Down will activate screenshot.

Status Bar Icons and Definition

	Connected to GPRS mobile network		Roaming
	GPRS in use		No signal
	Connected to EDGE mobile network		No SIM card installed
	EDGE in use		Vibrate mode
	Connected to 3G mobile network		Ringer is silenced
	3G in use		Phone microphone is mute
	Mobile network signal strength		Battery is very low
	Connected to a Wi-Fi network		Battery is low
	Bluetooth is on		Battery is partially drained
	Connected to a Bluetooth device		Battery is full
	Airplane mode		Battery is charging
	Alarm is set		GPS is on
	Speakerphone is on		Receiving location data from GPS
	New Gmail message		More notifications
	New text or multimedia message		Call in progress
	Problem with text or multimedia message delivery		Call in progress using a Bluetooth headset
	New Google Talk message		Missed call
	New voicemail		Call on hold
	Upcoming event		Call forwarding is on
	Data is syncing		Song is playing
	Problem with sign-in or sync		Uploading data
	SD card or USB storage is full		Downloading data
	An open Wi-Fi network is available		Download finished
	Phone is connected via USB cable		Connected to or disconnected from virtual private network (VPN)
	Phone is sharing its data connection via USB (USB tethering)		Carrier data use threshold approaching or exceeded
	Phone is sharing its data connection as a Wi-Fi hotspot (Wi-Fi tethering)		Application update available
	Phone is tethered in multiple ways		System update available

About Touch Gestures



Tap

Briefly touch surface with fingertip



Press

Touch surface for an extended period of time.

Press and Hold / Touch and Hold

Touch surface for an extended period of time and continue to hold the finger against the screen.

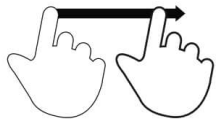

Drag

Move fingertip over surface without losing contact.



Flick

Quickly swipe surface with fingertip.

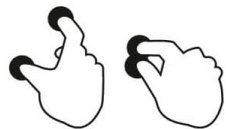

Spread - Zoom in

Touch surface with two finger and move them apart.

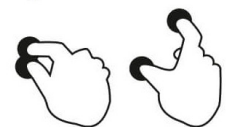

Pinch - Zooming out

Touch surface with two fingers and bring them closer together.

Out of Box Experience (OOBE)

Step 1:

- Tap anywhere to proceed with set up.

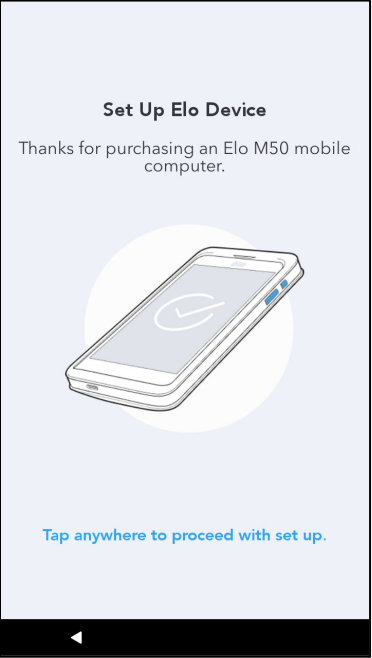

Step 2:

- Connect to Wi-Fi or tap "Set up offline" to skip Wi-Fi set up.
- To enroll with EloView you must connect to Wi-Fi.

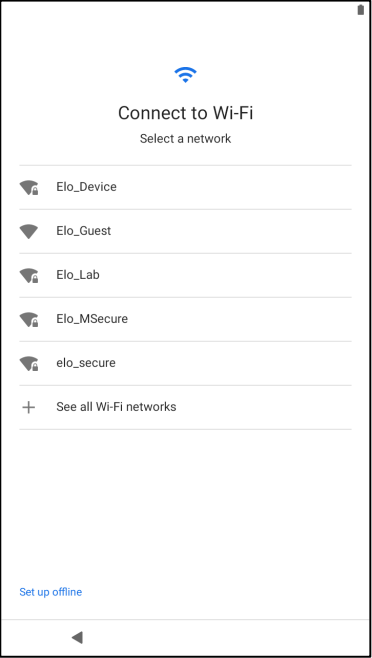

Step 3:

- Choose the following set up method.
- Follow on-screen instruction to complete the set up.

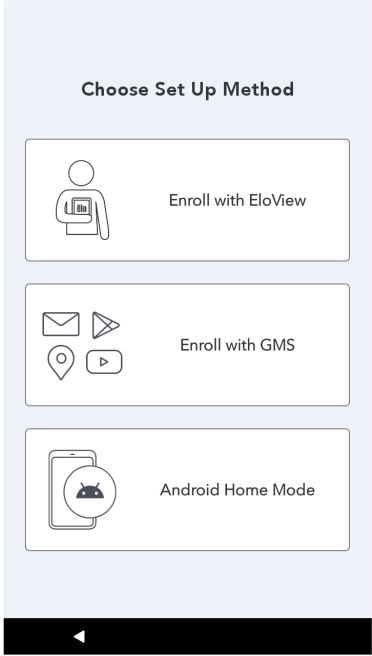



Elo Hub Home Screen

The Elo Hub Home Screen is the starting point for navigating of the device. You can place your favorite apps and widgets here.

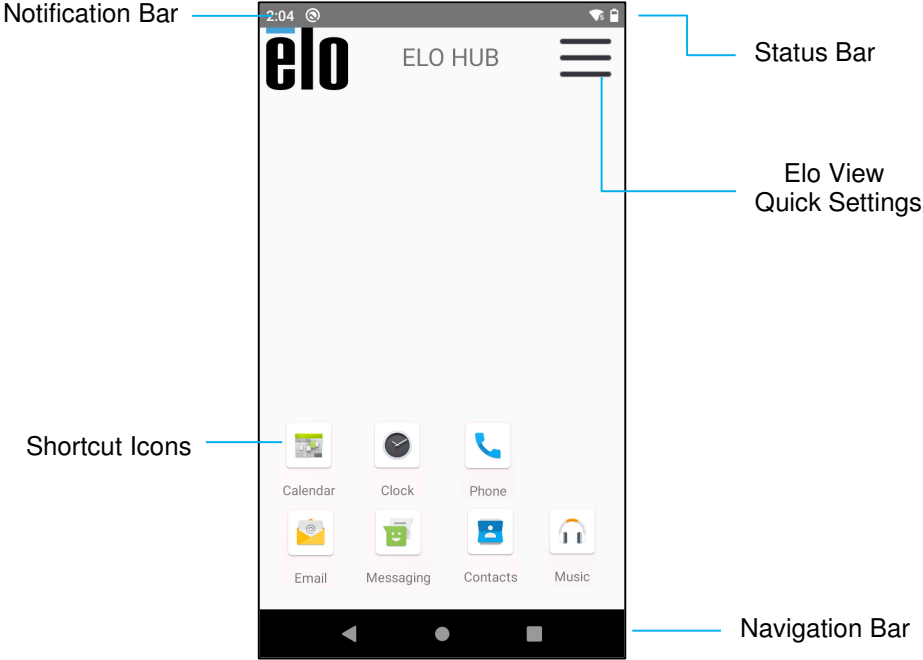
Note: The images below may appear different from the actual computer.



Navigation Bar

-  **Recent App** - Return to the previous page.
-  **Home** - Return to the home screen.
-  **Back** - Switch between recently used apps.

Elo Hub Quick Settings

To access the Quick Settings, tap  3 lines menu from Elo Hub Home Screen. Located on the upper right side.

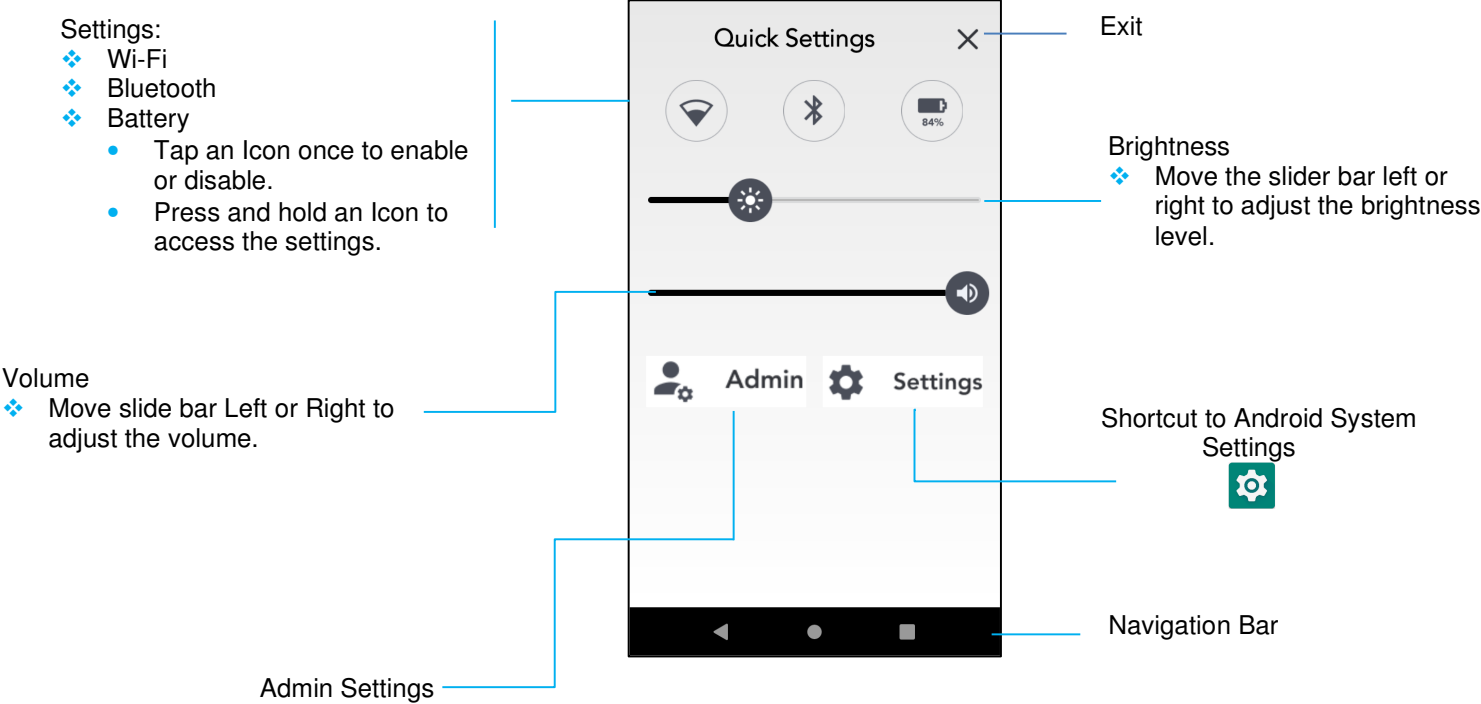

Lock and Home Screens

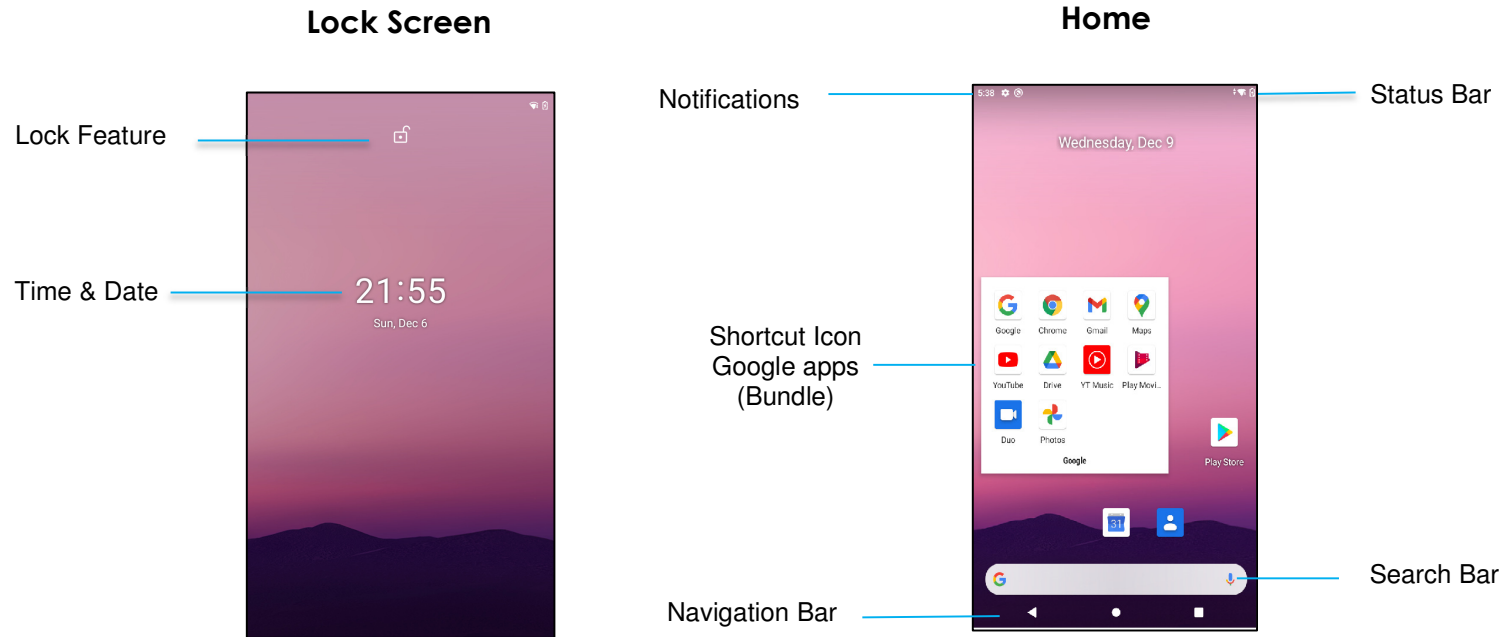

Note: The images below may appear different from the actual computer.



Home Screen is the starting point for navigating the computer. You can place your favorite apps and widgets here.

- To unlock the screen to **Home Screen**, swipe up on the **Lock Screen**.
Note: The default security is Swipe. Refer to Security settings section in this manual for advanced settings.
- To Lock the screen, press the power button once.

Navigation Bar

-  **Recent App** - Return to the previous page.
-  **Home** - Return to the home screen.
-  **Back** - Switch between recently used apps.

Android Notification Panel

The notification panel allows for quick access to setting shortcuts and notification alerts.

Note: The images below may appear different from the actual computer.

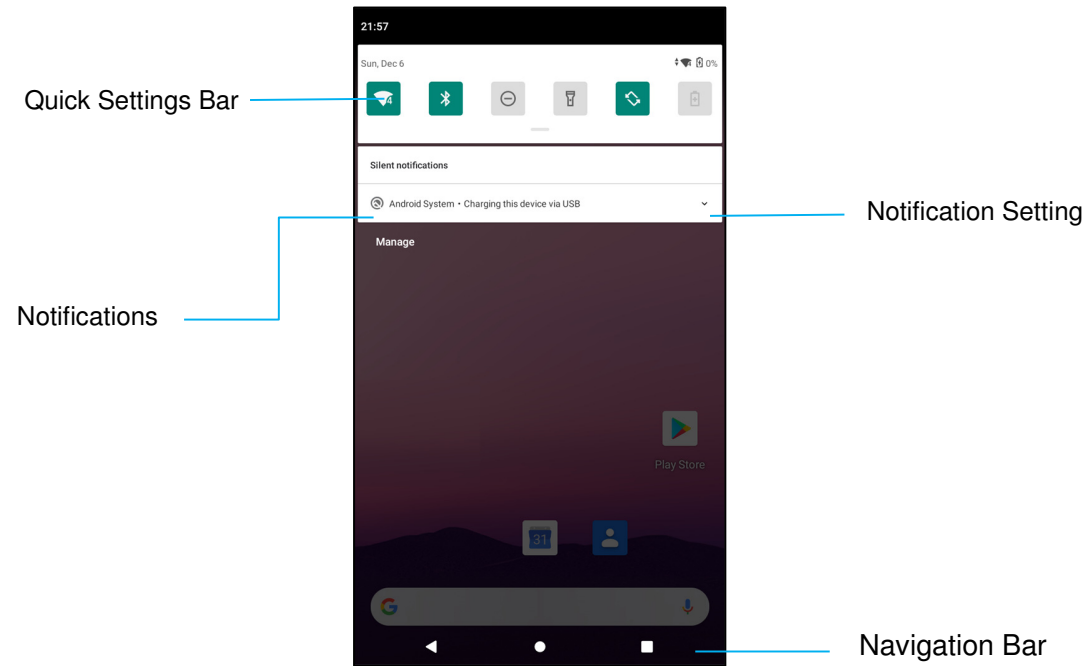

To open the Notification Panel

- From the **Home Screen**, swipe down from the top of the touch screen.
- To clear a single notification alert, drag the notification all the way to the left or right.
- To clear all notification alerts, tap "**Clear**".
- To customize notification alerts, drag the notification halfway to the left or right then tap  setting.
- To exit tap **Navigation Bar** feature or swipe up the notification alert menu.

Android™ Quick Access Panel

Access Panel allows for quick access frequently used settings, Brightness, and a shortcut to Android System Settings.

Note: The images below may appear different from the actual computer.

Quick Access Panel

- ❖ Wi-Fi,
- ❖ Bluetooth
- ❖ Do not Disturb,
- ❖ Flashlight
- ❖ Auto-rotation
- ❖ Battery Saver
- ❖ Sim card / Mobile Data
- ❖ Airplane mode
- ❖ Screen cast
- ❖ idle mode

- Tap an Icon once to enable or disable.
- Press and hold an Icon to access the settings.

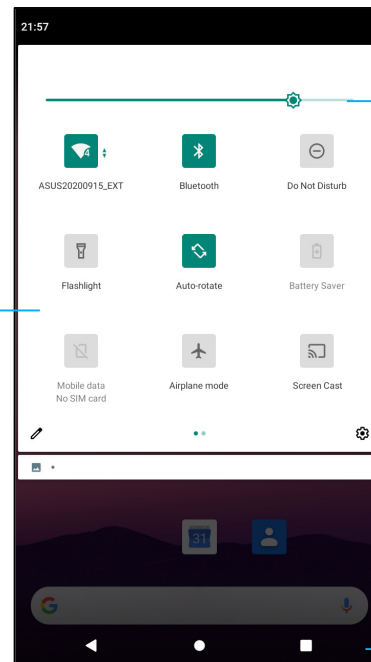

Brightness

- ❖ Move the slider bar left or right to adjust screen brightness.

Shortcut to Android System Settings



Navigation Bar

To open the Full Quick Access Panel

- From the **Lock Screen**, swipe down from top of the touch screen once.
- From the **Home Screen**, swipe down with two fingers from top of the touch screen.
- If the Notification Panel is open swipe down from the **Quick Settings bar**.
- For additional shortcut Icon's swipe screen from right to left.
- Tap **Navigation Bar** to exit.

Android application Drawer & Google application

The application drawer is a menu containing all the applications installed on the device including Android System Settings. This is different from the Home Screen, as it contains every installed app and cannot be customized.

Note: The images below may appear different from the actual computer.

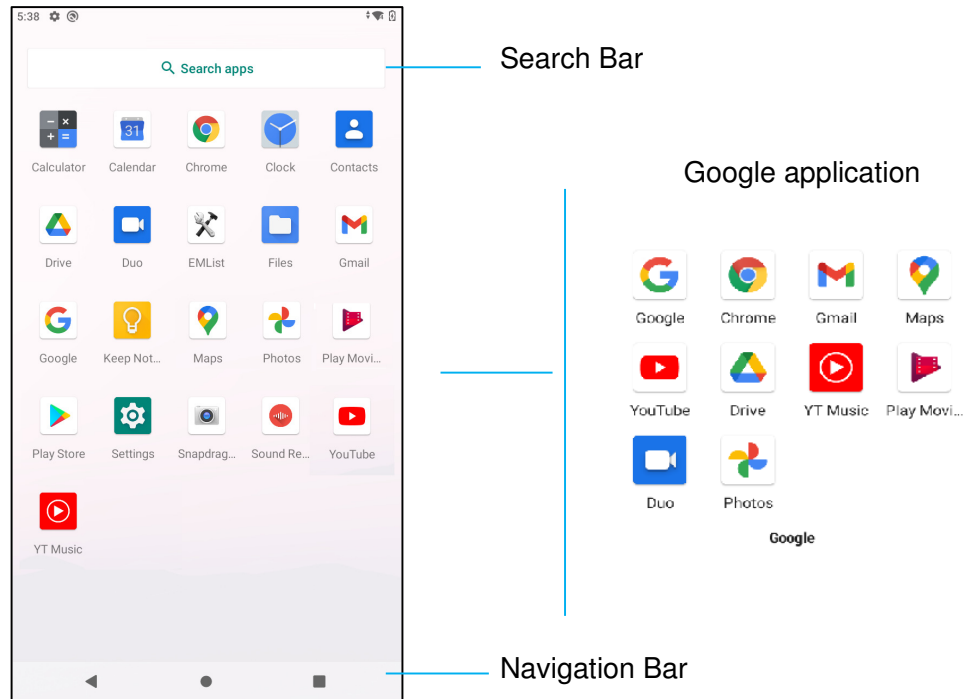

To open the Application Drawer (Manager)

- Swipe up the **Navigation Bar** from the **Home Screen**.
- To open an application, tap once.
- To exit from the **Application Drawer**, tap the Navigation Bar or swipe down.

Customize and add a shortcut to the Home Screen.

Note: The images below may appear different from the actual computer.

- From the **Application drawer**, press and hold an app or (Icon) then drag the Icon to move the app to the **Home Screen**.
- Drag the Icon into new location and release.

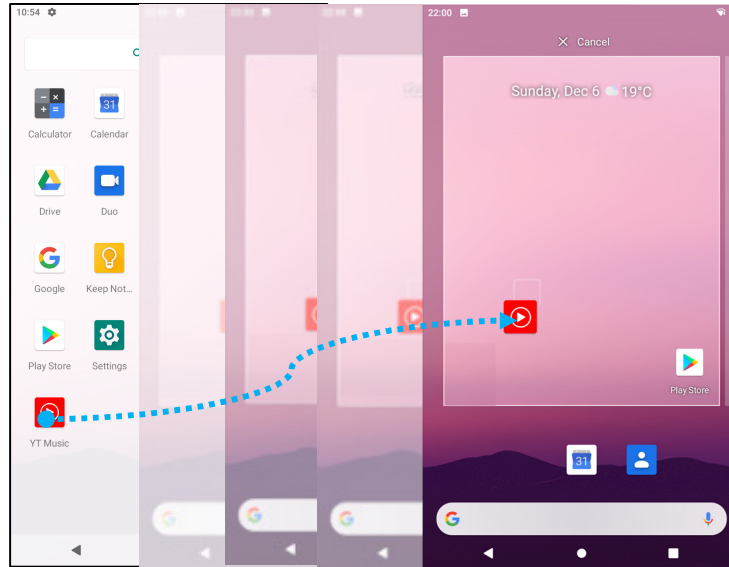

- To cancel, drag the icon to **"X Cancel"**.
- To remove a shortcut Icon from home screen, press and hold the Icon then drag the Icon to **"X Remove"**.
- To uninstall an app, press and hold then drag the icon to **"Uninstall"**.

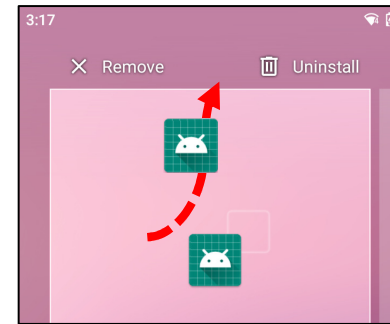
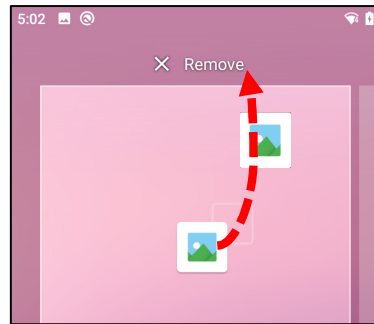
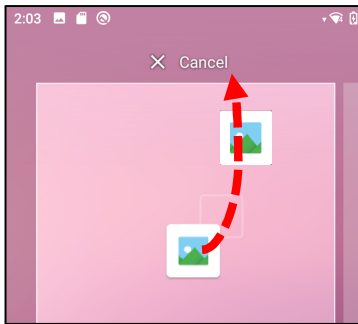

Section 3

Android System Settings



The Android System Settings menu allows you to control most aspects of your device - everything from establishing a new Wi-Fi or Bluetooth connection, to installing a third-party onscreen keyboard, to adjusting system sounds and screen brightness.



Network & Internet

The Network & Internet application allows you to access Wi-Fi, Airplane Mode, Mobile plan, Hotspot, Tethering and Advanced settings of Data Saver, VPN and DNS.

To set up Network and Internet, [enter Android Settings → Network & Internet →](#)

Wi-Fi

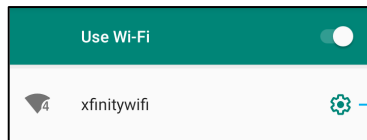

- Tap **Wi-Fi**.
- Tap **Use Wi-Fi** to enable .
- From the list, select a wireless network.
- When prompted enter the network password.
- Tap **Connect**.

For additional Network detail information's (IP address, Security, Frequency and Advanced), tap  setting of the network (e.g. xfinitywifi).



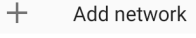

Wireless network setting



Joining Wi-Fi using QR code

- From the list of saved Wi-Fi scroll down and tap .
- Tap  (QR code) icon to the right of Add network.
- Position the viewfinder over the QR code on another device.

Sharing Wi-Fi using QR code

- Tap  setting of the connected device.
- Tap  (Share) icon.

Disconnecting a connected Wireless Network



- Tap  setting of the connected device.
- Tap  (FORGET) icon to disconnect.

Mobile Network

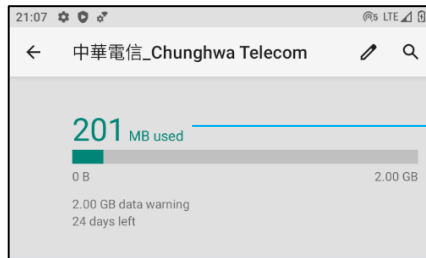

- Tap **Mobile network**.
- Internet service provider and data usage is shown on the top.



Total Data Usage

- Tap **Mobile data** to enable mobile data .
- Tap **Roaming** to enable roaming .
- Tap **Preferred Network Type** to choose preferred network available, e.g. LTE(Recommended)/3G.

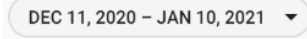
App Data Usage

- Tap  to set the period for mobile data usage calculation.
- Tap  to set data warning & limit.

Automatically Select Network / APN

- Tap **Advanced**.
- Tap toggle switch  to enable Automatic network select.
- Tap **Access Point Names** to select APN from the available APNs list.

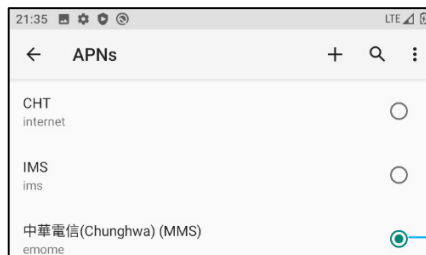

Tap to select the APN to be used

Airplane mode

This will disable all of the wireless transmission functions. Including cellular, Wi-Fi, and Bluetooth.



- To enable , tap **Airplane mode**.

Hotspot & tethering

Wi-Fi hotspot

This feature is for sharing Internet network connection with another device using Wi-Fi.

Note: The mobile computer must be connected to Wi-Fi. See *Network & Internet connection on this user manual*.

- Tap **Hotspot and tethering**.
- Tap **Wi-Fi hotspot**.
- Tap toggle switch to ON .
- Tap  QR code.
- The QR code is for another device to scan the password for easy connect.
- To enter manually the password, tap **Hotspot password**.

USB tethering

This feature is for sharing Internet connection to another device using a USB cable.

Note: The USB cable must be connected first from mobile computer to another device or PC. See *Connected device → USB on this user manual*.

- Tap **Hotspot and tethering**.
- Tap **USB tethering**, to enable .

Bluetooth tethering



This feature is for sharing internet network connection to another device using Bluetooth.

Note: The Bluetooth must be paired first from mobile computer to another device or PC. See *Connected devices → Bluetooth on this user manual*.

- Tap **Hotspot and tethering**.
- To enable , tap **Bluetooth tethering**.

Ethernet

Note: To connect the mobile computer to Ethernet, it will need an Elo I/O hub (E863687). When available, the mobile computer will automatically prioritize the ethernet connection. If the mobile computer does not, please follow the steps below.

- Place the mobile computer into the Elo hub.
- Set Wi-Fi to disable.
 - Go to Wi-Fi settings, tap **Use Wi-Fi** to disable .
- Tap **Ethernet**.
- Tap toggle switch to enable .



Connected devices

The Connected devices application allows you to pair Bluetooth devices, NFC, and USB (Tethering File transfer MDI and PTP)

To setup, [enter Android](#)  [Settings](#) → [Connected devices](#) →

Bluetooth

Note: Make sure the BT device is on discoverable.

- Tap **Connection preferences**.
- Tap **Bluetooth**.
- Tap toggle switch to ON .
- Tap **+ Pair new device**.
- From Available devices screen, tap a device to pair.
- When a pairing request message appears.
 - Verify the pairing number is the same.
 - If the pairing requests a PIN, enter the PIN.
- Tap **PAIR**, to connect.
- When the Bluetooth device is successfully connected to mobile computer, the connection will show as Active or Connected.

Unpair a paired Bluetooth Device

- Navigate back to 'Connected devices' screen, from **AVAILABLE MEDIA DEVICES** or **PREVIOUSLY CONNECTED DEVICES**.
- Tap  settings of the connected device (e.g. JBL Flip 3).

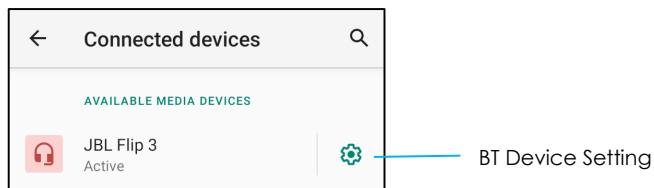

- In the settings menu, it is possible to **DISCONNECT, FORGET** (to unpair the device) and to enable and disable Phone calls, Media audio and Contact sharing.

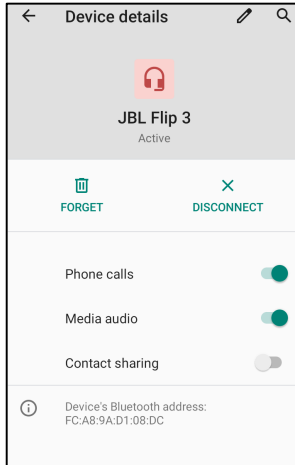

NFC

Is a short-range high frequency wireless communication that enables the exchange of data between devices.

- Tap **Connection preferences**.
- Tap NFC to  enable or  disable.

Cast

This allows to mirror Elo mobile computer screen on a wireless display device (e.g. Smart TV).

Note: Make sure the wireless display capable device and mobile computer are on the same wireless network. See *Network & Internet connection on this user manual*.

- Tap **Connection preferences**.
- Tap Cast.
- Tap  3-dots menu.
- Tap **Enable wireless display** to begin scanning for compatible displays.

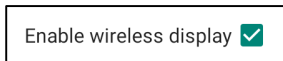

- From the list, tap a wireless display (e.g. TV). From the Wireless Display device (TV), if promoted tap **Allow**.

Disconnect and forget a connected wireless display

- To stop the device from casting, tap the connected wireless display (e.g. TV).
- Tap **DISCONNECT**.

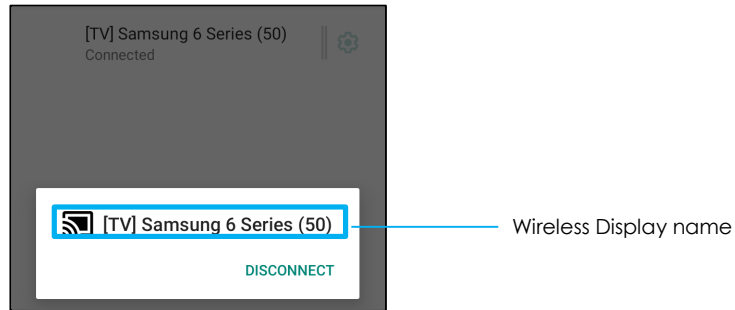

To forget a device

- Tap  setting of connected wireless display.
- From wireless display options screen, tap **FORGET**.

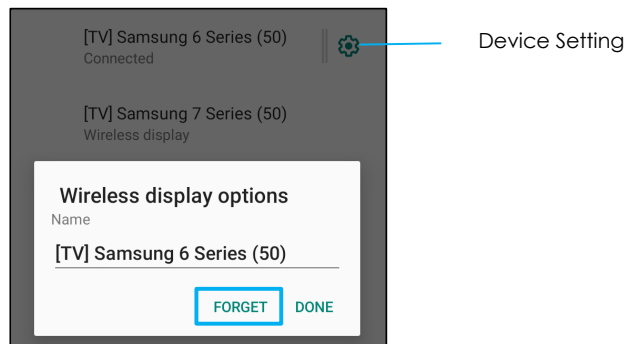

To stop scanning available wireless display to cast

- Tap  3-dots menu.
- Tap **Enable wireless display** to be unchecked

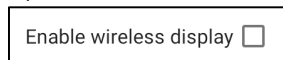

Print

Note: Make sure mobile computer and printer are connected to the same network.

- Tap **Connection preferences**.
- Tap **Printing**.
- Tap **Default Print Service**.
- Tap toggle switch to ON .

- Tap  3-dots menu.
- Tap **Add printer**.

To add a printer using Wi-Fi printer:

- Tap **Wi-Fi direct printing** to enable .
- If prompted, tap '**ALLOW ONLY WHILE USING THE APP**' to allow the device.
- Tap **Wi-Fi Direct printers** to start searching for a Wi-Fi printer to add.
- Tap the printer's name to connect.

To add a printer entering IP address:

- Tap **Add printer by IP address**.
- Enter the printer's IP address.

USB

For data transfer and network sharing using a USB connection.

Note: To activate the USB settings, connect the USB cable from mobile computer to another device or PC. Once the mobile computer detects the device, it will become available in the USB preference settings.

- Tap USB.
- From USB Preferences under USE USB FOR choose and tap a feature to enable.

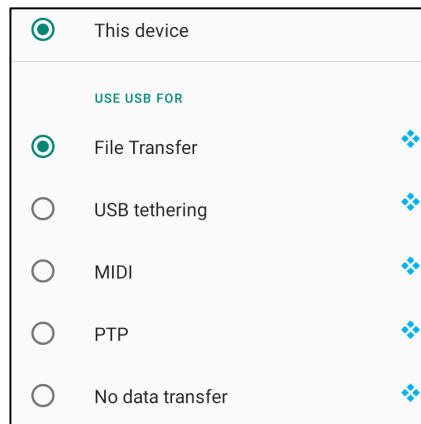

❖ **File transfer** – This will share mobile computer internal and SD shared storage.

❖ **USB tethering** – This will share internet network connection.

❖ **MIDI** - Musical Instrument Digital Interface.

❖ **PTP** - Picture Transfer Protocol.

❖ **No data transfer** – (Default Setting) No data will be transferred even if the USB cable is connected.



Apps & Notification

App & Notification settings are to streamline app alerts by changing which apps send notifications and how the notifications alert you.

To manage App & Notification, [enter Android !\[\]\(feabb98897b440bc8695a03336a6e2df_img.jpg\) Settings → App & Notification](#)

Setting notifications

- In the Recently opened apps, tap **SEE ALL APPS** or **App info**.
- From App Info screen tap an App to set the notification (e.g. Android Keyboard).
 - ❖ In the App property settings, you can also **DISABLE**, **ENABLE**, and **FORCE STOP** the app.

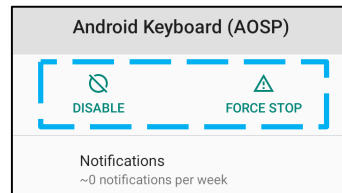

- To enable or disable notifications, tap **Notifications**. Then select **Show notifications**.

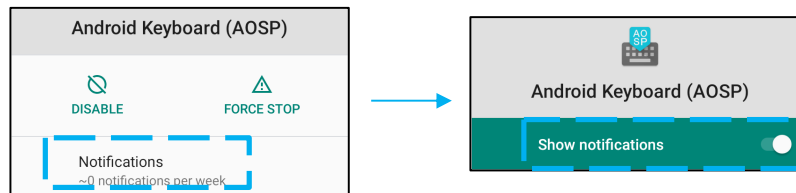

- To add a dot for unread notifications, tap **Advanced** then tap **Allow notification dot**.

Resetting app preferences

This will not lose any app data.

- Tap  3-dots menu from App Info screen.
- Tap **Reset app preferences** then tap **RESET APP**.

Setting Permission manager to an application

- To manage a preference's permissions to an app (e.g. **Android Keyboard**), tap **Permissions**.
- To allow a permission to an application, tap an app from **DENIED** menu.
- To deny a permission to an application, tap an app from **ALLOWED** menu.

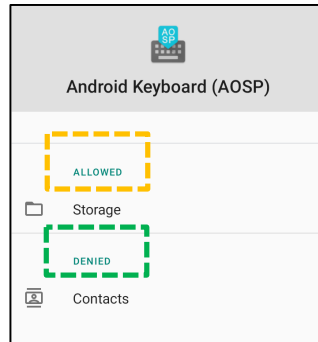

Setting notifications in the lock screen

- To set up notification in the lock screen from Apps and notification screen, tap **Notifications**.
- Tap **Notification on lock screen**. Then follow on-screen instruction on how notifications appear in the lock screen.

For additional settings

- Tap **Advanced**.
- Tap a feature to enable or disable.

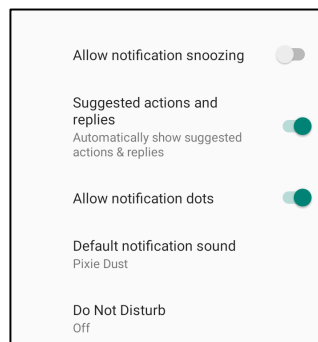

Setting Permission manager on apps using storage, phone, and location

- To give permission to an app, tap **Permission manager** from Apps and **notifications screen**.
- In the menu of permission manager, tap an app to manage that app's permissions (**e.g. Camera**).
- From the camera properties, choose an app to manage.
- To allow a permission to an application, tap an app from **DENIED** menu.
- To deny a permission to an application, tap an app from **ALLOWED** menu.

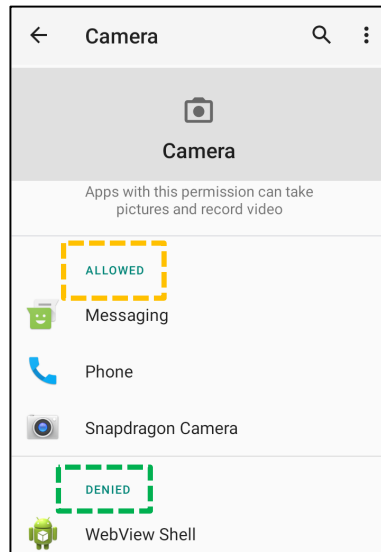

Setting Emergency alerts

- Tap **Advanced** from the Apps and notifications screen.
- Tap **Emergency alerts**.
- From the menu of alerts, tap a features to enable or disable.

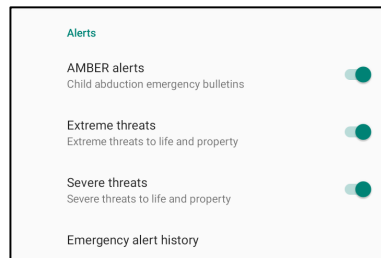

- For Sound and Vibration settings, tap **Vibration** to enable or disable under Alert Preferences.
- For Alert reminder settings, tap **Alert reminder sound**.

Battery



The battery application monitors the battery's status, performance, and charging state.

To modify Battery settings, [enter Android](#)  [Settings](#) → [Battery](#) →

Battery Saver

The battery saver turns off, or restricts, background activity, some visual effects, and other high-power features to extend battery life.

Note: The Battery Saver will suspend these features when the device is charging.

- Tap **Battery Saver**.
- To manually enable or disable Battery Saver, tap **TURN ON NOW** or **TURN OFF NOW**.
- In the ON mode, the screen theme display will turn dark and the battery status icon will display this icon .
- To automatically enable Battery Saver in a certain power percentage threshold, **tap Set a schedule**.
- Tap **Based on percentage to** set a power percentage when the Battery Saver feature will enable.
- From the slider bar move the slider right or left to choose the power percentage from 5% to 75%. The default is 5%.
- To do nothing, tap **No Schedule**.
- Enabling  "Turn off when full charged", the Battery Saver turns off when battery is at 90%.

Battery Manager

When the Battery Manager detects that apps are draining the battery, you will have the option to restrict the application. Restricted apps may not work properly, and notifications may be delayed.

- Tap **Battery Manager**.
- Tap **Use Battery Manager** to enable.

Battery percentage

This feature will show battery percentage in the status bar.

- To enable and disable, tap **Battery percentage**.

Battery Usage

This feature will show all list of all apps how much battery power they are using.

- Tap **3-dots menu** to enter in the battery usage.

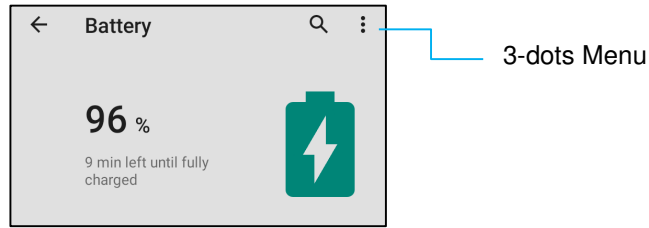

- Tap **Battery usage**.
- To show full device usage, tap 3-dots menu again.

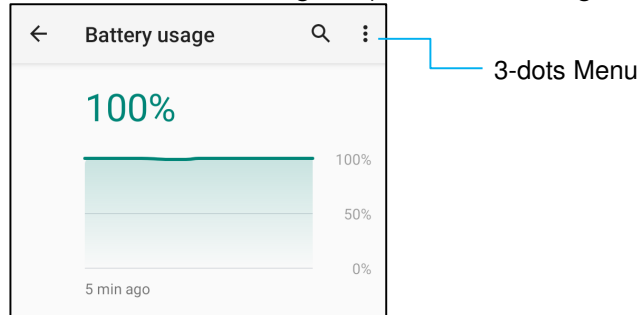

Additional Information

- When battery power drops to 15%, a pop-up warning will appear on the display.

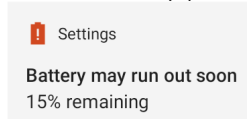

Display

The Display application manages the screen's display settings.

To modify Display settings, [enter Android](#)  [Settings](#) → [Display](#) →

Auto Idle mode

- Tap **Auto idle mode** to enable  or disable .

Brightness Level

- Tap **Brightness level**.
- Move the slider bar right or left to adjust the screen's brightness.



Nigh Light Feature

This feature will tint the screen to amber. This makes easier to look at the screen or read in dim light.

- Tap **Nigh Light**.
- Tap **TURN ON NOW**.
- To adjust intensity, move the slider bar right or left.

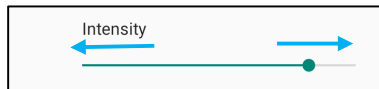

- To disable, tap **TURN OFF NOW**.

Customizing a time schedule



- Tap **Schedule**.
- Select **Turn on at custom time**.
 - ❖ Tap **Start time** to set the time (for example at 10:00PM).
 - Tap **OK** to execute.
 - ❖ Tap **Enter time** to set the time (for example at 6:00AM).
 - Tap **OK** to execute.

To disable the time schedule

- Tap Schedule.
- Tap None.

Adaptive Brightness

This feature will automatically adjust the screen brightness to your environment.

- Tap **Adaptive Brightness**.
- Tap **Adaptive Brightness** to enable  or disable .

Wallpaper

- Tap **Wallpaper**.
- Select a wallpaper from the following options.
 - ❖ Live Wallpapers
 - ❖ Snapdragon Gallery → Download – Picture – Screenshot
- Select an image or picture you want as a wallpaper from the folders.
- Tap SET WALLPAPER.



Advanced

Dark theme

- To switch screen theme on dark (black color) or light (white color), tap **Dark** / .

Screen timeout

- Tap Screen timeout.
- Select the time limit from the following option.

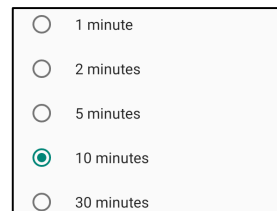
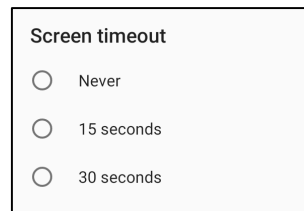

- Tap to save.

Auto-rotation screen

- Tap Auto-rotation screen to enable or disable.

Font size

- Tap Font size.
- Move the slider bar left or right to adjust the text size.

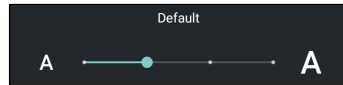

Display size

- Tap Display size.
- Move the slider bar to left or right to adjust the screen size.

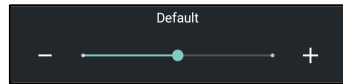

Screen saver

- Tap Screen saver.
- Tap Current screen saver to make changes to the current settings.

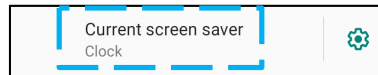

- Select a screen saver from Clock, Colors, Photo Frame, and Photo Table.
- For additional clock, Photo Frame, and Photo Table screen savers, tap  setting.

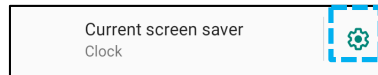

- To activate Screen saver, tap START NOW.



Screen Orientation

- Tap Screen Orientation.
- Select the orientation from the following option.

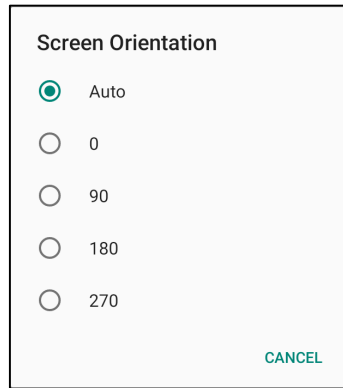

- Tap to save.

Lock screen display

- Tap Lock screen display.
- Tap Lock screen.
- Tap on Show all notification content.

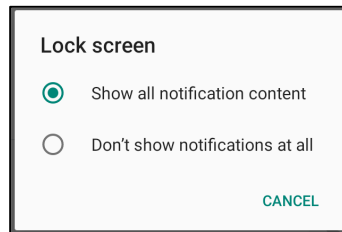

- To enable and disable users from lock screen.
 - ❖ Tap Add user from lock screen
- To add lock screen message, tap Lock screen message.
 - ❖ Enter a message and tap SAVE.

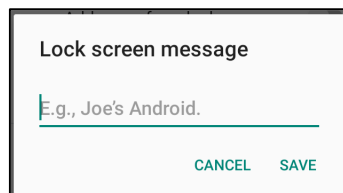

Sound

The sound application is to manage audio, vibration and Do not Disturb features.

To modify settings, [enter Android !\[\]\(34b4f260a8587d2e97eeaee361cc357b_img.jpg\) Settings → Sound →](#)

Volumes

- To decrease or increase the following sound volume, drag slider left or right.

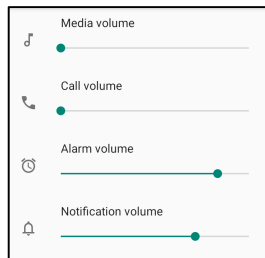

Do not Disturb

- **Tap Do not Disturb.**
- Tap **TURN ON NOW**, to enable Do not Disturb,
 - ❖ To manage settings, tap a feature you wish to manage and follow on-screen instructions to complete the set up.

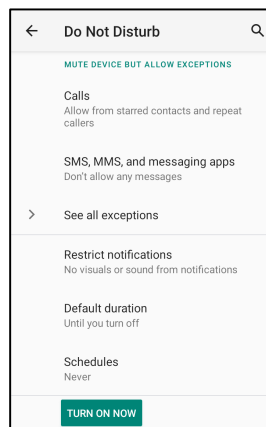

- To disable, tap **TURN OFF NOW**

Prevent Ringing

- Tap **Shortcut to prevent ringing**.
- Tap toggle switch to  enable.
- Select from the following options.

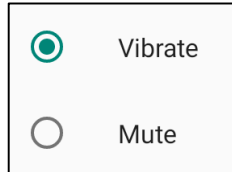

- To disable , tap toggle switch.

Default Notification Sound

- Tap **Default notification sound**.
- Select a sound from the list (e.g. Pixie Dust) and tap **OK** to save.

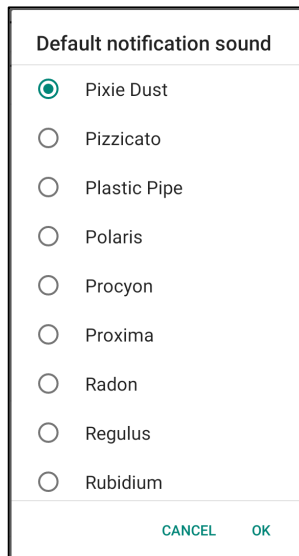

Default Alarm Sound

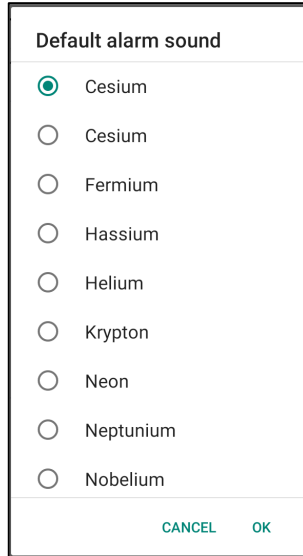

- Tap **Default Alarm sound**.
- Select an alarm sound from the list (e.g. Cesium) and tap **OK** to save.



Screen locking Sound

- To enable  or disable , tap Screen locking Sounds.

Advanced

- To enable  or disable  on the following features below, tap a feature.

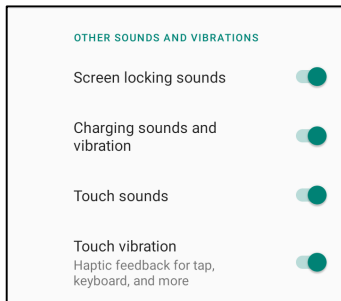

Storage



To manage Storage, [enter Android !\[\]\(1d3a1175dd4902218e694b9c098adb83_img.jpg\) Settings → Storage →](#)

Internal Shared Storage

- To check the status of internal memory storage, tap Internal Shared storage.

Storage Manager

This feature is to help free up storage space, storage manager removes backed up photos and video from the device.

- To enable  or disable , tap Storage manager.
- To make changes to set days on removing photos and videos, tap Remove photos & Videos.
- Select from the options below.

Over 30 days old
Over 60 days old
Over 90 days old

- Tap Recent App to exit.

SD card

- To manage SD card, tap SD card.
- To safely eject SD card, tap  eject.
- To remount the SD card, tap SD card.
- Tap MOUNT.

Key Remap

The Key Remap applications allows you to program the left and right function buttons from controlling the device volume, barcode reader trigger and other hardware buttons.

To modify the settings, [enter Android !\[\]\(2bdfe261b986065ee0ac76460d6528c9_img.jpg\) Settings → Key Remap →](#)

From the settings, tap an Icons you wish to manage.

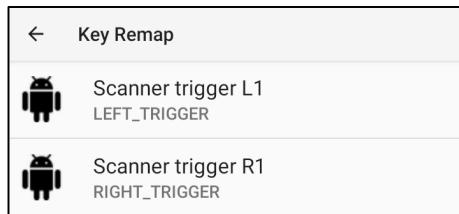

To program “**Left Function Button**” for barcode left trigger choose “**Scanner trigger L1**”.

To program “**Right Function Button**” for barcode Right trigger choose “**Scanner trigger R1**”.

Wakeup Source

The Wakeup Source applications allows you to program the “Left, Right Trigger buttons and Touch Screen” to wake up the device from sleep or idle mode.

To modify the settings, [enter Android !\[\]\(aa53ad6fea213b8b2226d3077e30533a_img.jpg\) Settings → Wakeup Source →](#)

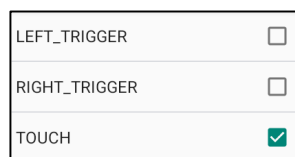

Tap to Enable (Checked) or Disable (Unchecked).



The Privacy application is to give you control over what permissions of applications can have.

To manage permission, [enter Android](#)  [Settings](#) → [Privacy](#) →

Permission Manger

This is to grant permission of an App that uses storage, phone, and location.

- To manage permissions to an app, tap **Permission manager**.
- From the menu of permission manager, tap an app you wish to manage (**e.g. Camera**).
- From the camera property shows what applications has camera permissions.
- To allow a permission to an application, tap an app from **DENIED** menu.
- To deny a permission to an application, tap an app from **ALLOWED** menu.

Show passwords

This will display character briefly as you type a password.

- To enable  and disable  , tap **Show passwords**.

Lock screen

This will show all notification content in the lock screen.

- To enable  and disable  , tap **Lock screen**.

Location

To modify Locations settings, [enter Android](#)  [Settings](#) → [Location](#)

- Tap Location.
- To enable or disable, tap Use location

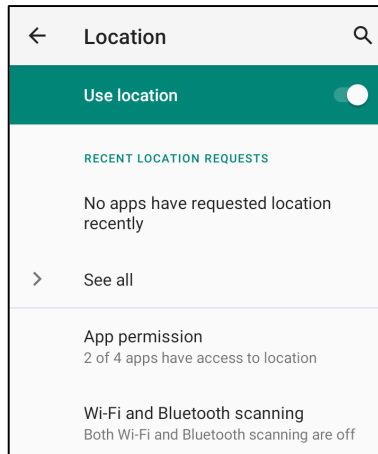

- For apps have requested location recently, **tap See all.**
- To update permission, tap **App permission.**
- To scan for Wi-Fi networks and Bluetooth, tap **Wi-Fi and Bluetooth scanning,**

Note: This feature allows app and services to scan for Wi-fi networks and Bluetooth anytime. This can be used to improve location-based features and services.

Security

To change Security settings, [enter Android !\[\]\(35e4f762fc1cfea5610d92e2d225d5b4_img.jpg\) Settings → Security →](#)

Screen Lock

- Tap Screen lock.
- From the menu select a security you wish to set. The default security is Swipe.

Swipe Security

- Tap Swipe.

Pattern Security

- Tap Pattern.
- Tap YES.
- Draw a Pattern for security (see image for an example) and tap NEXT.

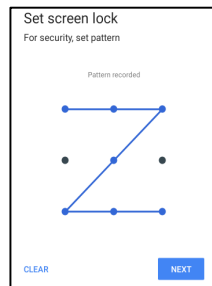

- Draw the same pattern again and tap CONFIRM.
- Follow on-screen instruction and tap DONE.

Pin Security

- Tap PIN
- Tap YES.
- Enter a PIN number must be at least 4 digits minimum and tap NEXT.

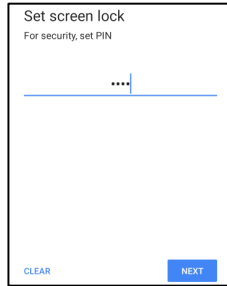

- Re-enter PIN numbers and tap CONFIRM.
- Follow on-screen instruction and tap DONE.

Password Security

- Tap Password.
- Tap YES.
- Enter a password, must be at least 4 characters minimum and tap NEXT.

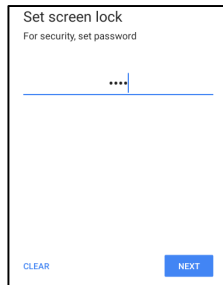

- Re-enter password and tap CONFIRM.
- Follow on-screen instruction and tap DONE.

Remove Screen Lock

- To remove screen lock, tap Screen lock.
- If prompted enter the Password (only applicable for PIN, PATTERN and PASSWORD security).
- Tap None to remove screen lock.
- Tap YES.
- Tap REMOVE to confirm.

 Accounts



To add an account, enter Android  Settings → Accounts

- To set up an account, tap Account.
- Tap + Add account.
- Enter an email account.
- Enter an Account type you want to add (PERSONAL - POP3 or PERSONAL – IAMP).
- Follow the on-screen instructions to complete the setup.

Accessibility

The Accessibility is a large on-screen menu to control Elo Mobile Computer Android device. You can control display, audio & on-screen text and more.

To modify settings, [enter Android Settings](#)  [Settings → Accessibility](#)

- From the menu, select a feature to change the setting.
- To enable  or disable , tap the feature.
- To adjust slide bar, drag slider right or left.



- For other settings, tap the feature and follow the on-screen instruction to complete the setup.

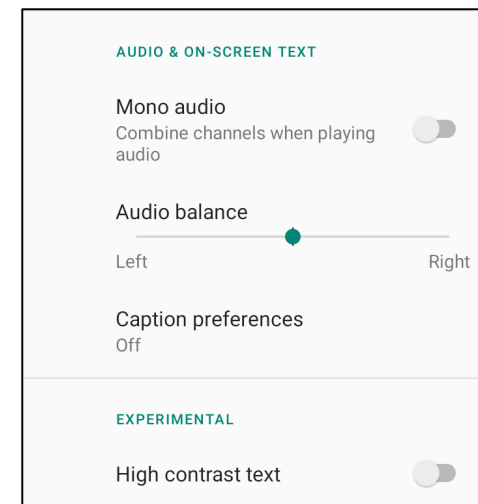
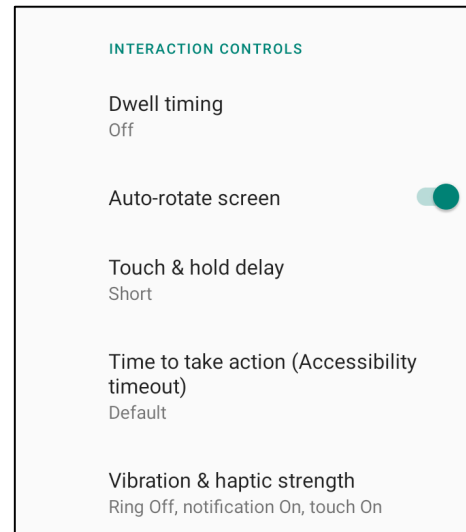
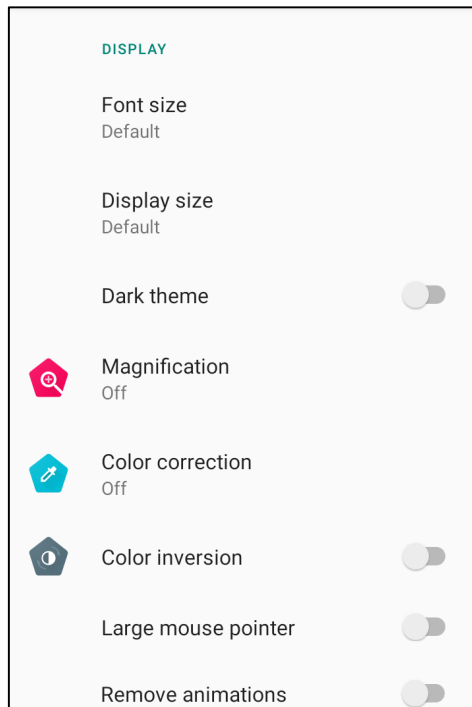



System

To modify settings, [enter Android](#)  [Settings](#) → [System](#) →

Languages & input

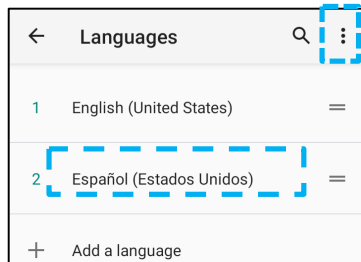
- To change language, tap Languages & input.
- Tap Language.
- Tap + Add a language, then choose from the list of languages to add (e.g. Espanol).



- After choosing a language, tap  3-dots menu then tap Remove.
- To change a language e.g. from English to Espanol, tap English then tap .

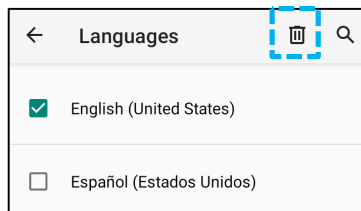

- Tap OK to remove selected language.

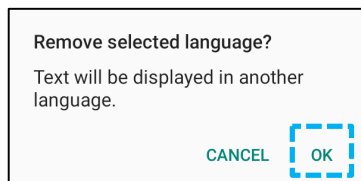

Gestures

- Tap Gestures.

For camera gesture

- Tap Jump to camera.
- Tap Jump to camera to enable  or disable .
- ❖ When set to enable, pressing power button twice will activate, the digital camera.

For notification volume gesture

- ❖ Tap Preventing ringing
- ❖ Tap toggle switch to ON or OFF.

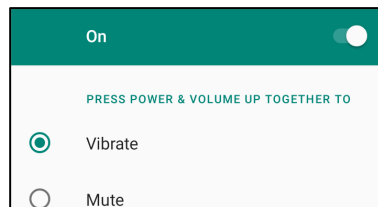

- ❖ When set to Vibrate mode and notification volume is active, pressing power + volume up buttons together, the notification volume will be set to vibrate mode.
- ❖ The vibrate mode Icon will also show into status bar.

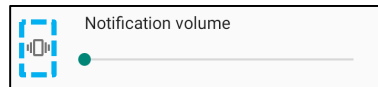

- ❖ When set to Mute mode and notification volume is active, pressing power + volume up buttons together, the notification volume will be muted.
- ❖ The mute Icon will also show into status bar.

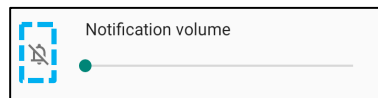

Date & Time

Note: The recommended setting for “**Date and Time**” is to use, “**USE network provided time**”.

And for **Time zone** when is set to “**USE network provided zone**”, you need a sim card to work.

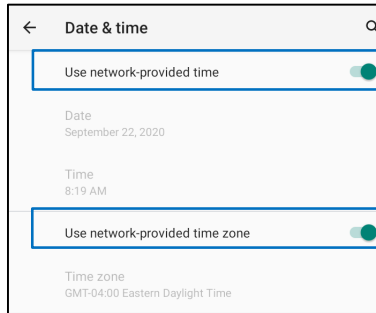

For manual settings:

- To set time and date, tap Date & Time.
- Tap Use network-provided time to disable.
- Tap Date then enter date.
- Tap Time then enter time.

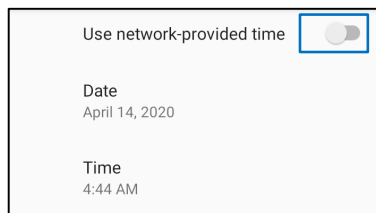

- To set time zone, tap network -provided time and select your time zone.

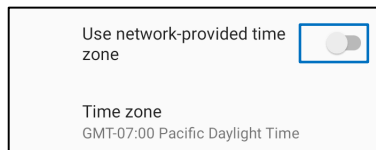

- To set to 12 hours format, tap Use locale default.

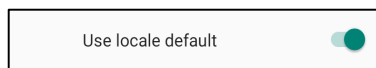

- To set 24 formats, tap Use 24-hours format.

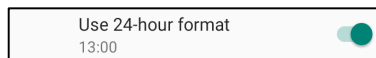

Advanced

Reset options

- To select a following option to reset, tap Reset options.
- From the list, select an item to reset then tap to execute and follow on-screen instruction.

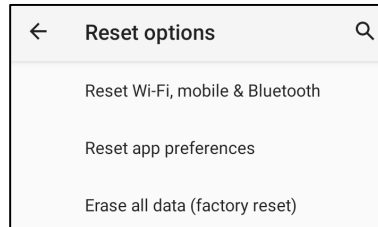

Multiple users

- Tap Multiple users.
- Tap toggle switch to  ON.

To switch users

- Tap a user or name from the following option.

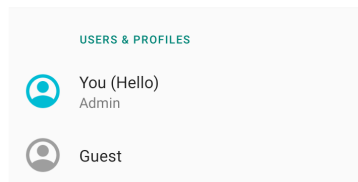

To add user

Note: only admin can add users.

- Tap **+ Add user or profile**.
- To set up apps and contents for the user, tap **User**.
Follow on-screen instructions to complete account set up.
- To set up restriction access to apps and content for the users, tap **Restricted profile**.
Follow on-screen instructions to complete account set up.

To delete guest from the device

- Tap  3-dot menu from **Multiple Users** screen.
- Tap **Delete Guest** from this device.

To rename Admin Profile info

- Tap  admin
- Enter the name.
- Tap **OK** to save.

Developer (Accessing developer option menu)

- To access Developer option menu, go to **About phone** → **Build number**.
- Tap Build number 7 times. When successfully done you will see the message “You are now a developer”.
- Then go back to  → **System** → **Advanced**.



About Handheld

For viewing specific information of mobile computer.

To view and modify settings, enter **Android**  **Settings → About phone**

Device name M50C
Emergency information Info & contacts for Owner
Legal information
Regulatory labels
SIM status Not available
Attestation keys and certificates Unknown
Model & hardware Model: M50C
IMEI 866834041334140
Model description M50C
Android version 10
IP address Unavailable
Wi-Fi MAC address 1c:ee:c9:1a:50:f3
Bluetooth address 1c:ee:c9:1a:50:f4
Up time 02:20
Build number 5.0.120+p

- Tap once to change the device name.
- Tap once to view add, and update emergency information.
- Tap once to view.
- Tap once to view SIM status.
- Tap once to view.
- Tap once to view Model, Hardware and Serial number information.
- Tap once to view IMEI information – IMEI and IMEI SV.
- Elo Mobile Computer Model description.
- Tap once to view Android version, Security, Google Play system update, Baseband version, Kernel version and Build number.
- Network address information.
- Bluetooth address information.
- Total time when mobile computer, is in operation.
- Tap 7 times to access Developer options menu in the **System** → **Advanced settings**.

Section 4

Operational



About Camera App (Snapdragon)

Camera Features

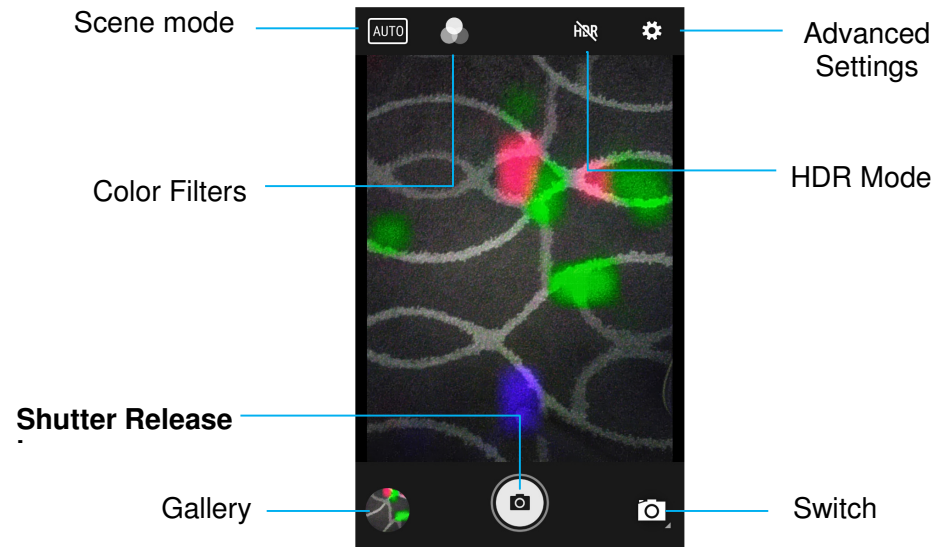

Switch - A switch between Camera to Video and Panorama.

Scene mode - For selecting the best exposure settings to fit the type of scene being shot. That is, in addition to the amount of light in the scene. Options include: HDR, Portrait, Landscape, Sports, Flowers, Backlight, Candlelight, Sunset, Night, Beach and Snow.

Color Filter - For photo effect. Options include Mono – Sepia – Negative – Solarize – Posturize – Aqua – Emboss - Sketch -Neon.

HDR - High Dynamic Range. The camera will process photos slightly differently than normal to capture greater detail from bright and dark areas in your photo.

Shutter Release - For taking picture.

Gallery – For viewing captured picture.

Advanced Settings

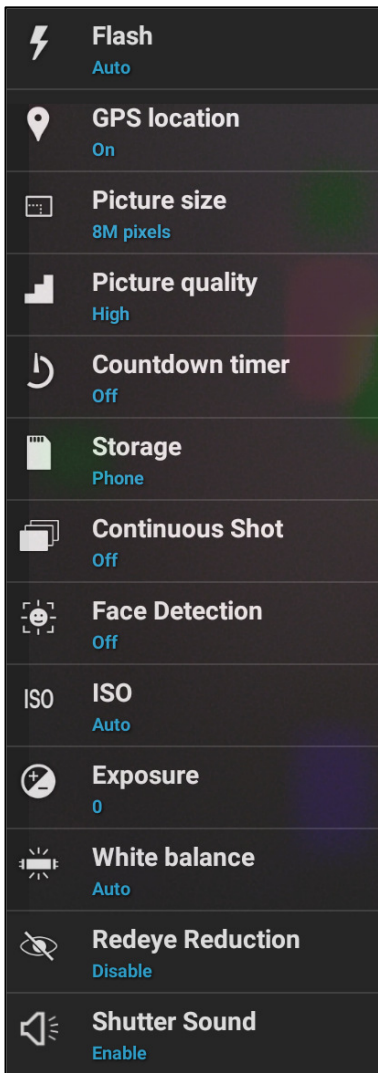

- To help illuminate a scene or an object when taking picture.
- For showing location information in an image to show the photographer where the camera was when the photo was taken.
- For changing picture resolution.
- For enhancing photos and images.
- Is a timer that gives a delay between pressing the shutter release. It is most used to let photographers to take a photo themselves (often with family), hands free.
- For managing photos and videos where to save.
- For taking multiple photographs to be taken within a short timeframe and in rapid succession.
- For detecting faces in the images and recognize them to automatically adjust focus and exposure.
- For brightening or darkening an image (photo). The lower the number of ISO the darker the photo and the finer the grain. The higher the brighter of the photo and is often use in darker situations
- Exposure is the amount of light which reaches your camera sensor. It is a crucial part of how bright or dark your pictures appear.
- For eliminating the discoloration in an image due to certain colors in the scene having more intensity and/or a higher or lower “temperature”.
- For reducing redevye when taking a picture using flash.
- Play a tone when taking a picture.

Video Features

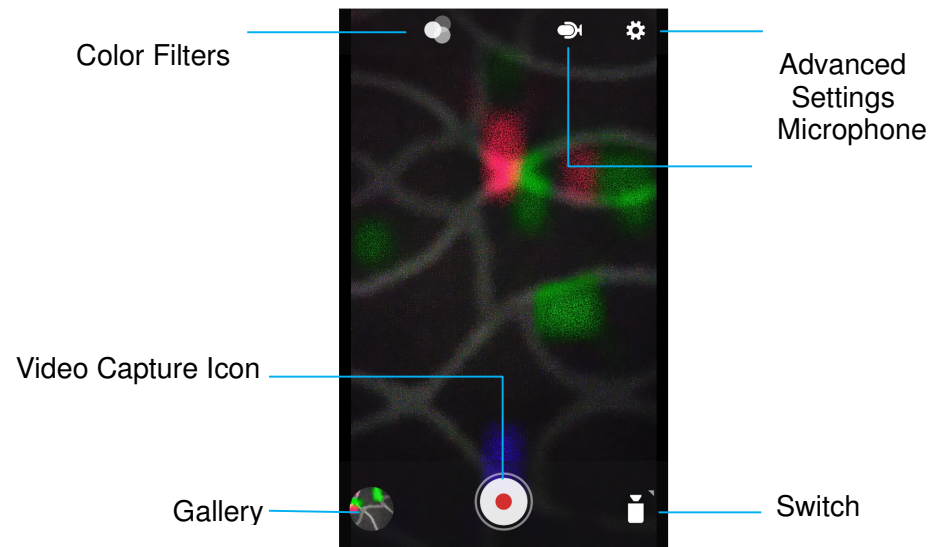

Switch - A switch between Video, Camera and Panorama.

Color Filters - For video effect. Options include: Mono – Sepia – Negative – Solarize – Posturize – Aqua – Emboss - Sketch -Neon.

Video Capture - For capturing video.

Microphone - For capturing sound on video.

Gallery – For viewing captured videos.

Advanced Settings

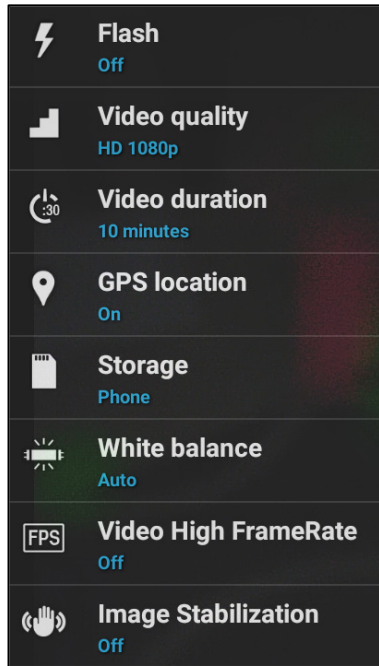



- To help illuminate a scene or an object when taking video.
- For changing video resolution.
- Is an auto timer to stop video recording without pressing video capture Icon.
- For showing location information in a video to show the videographer where the video camera was when the video was taken.
- For managing photos and videos where to save.
- For eliminating the discoloration in a video due to certain colors in the scene having more intensity and/or a higher or lower "temperature".
- For adjusting frequency (Frame Per Seconds).
Note: 120fps, and higher frame rates are used for recording video to be played back in slow motion.
- To help stabilize a video recording on a shaky video camera.

Take a Picture and Record Video

- Tap  Snapdragon camera app to access the Digital camera.
- To change camera and video settings, see features.
- From the switch, located on bottom left side of the mobile computer select one from the following options.





For Panorama, tap  Panorama Icon.

- ❖ To take panoramic pictures, tap  panorama shutter Icon.
- ❖ Slowly move the device across to take a panoramic picture.
- ❖ When finished, tap  stop Icon.





For Video recording, tap  Video Icon.

- ❖ To record videos, tap  capture Icon.
- ❖ To mute and unmute sound while recording, tap microphone Icon.
- ❖ When finished recording, tap  stop Icon



For camera, tap  Camera Icon.

- ❖ To take pictures, tap  shutter release Icon.
- ❖ To enable and disable shutter sound, go to advanced settings. See camera features.
- ❖ To zoom an object or scene place two fingers on the screen together, spreads them apart to zoom in and pinch to zoom out.
- ❖ To auto focus an object or scene, tap touch screen.
- ❖ To view pictures and play recorded videos, tap gallery.
- ❖ To play recorded video, tap  play.

Take a Screenshot









For capturing an image of the screen. The device will automatically save the image in the  File folder application.

- To take a screenshot, press and hold Power and Volume buttons together.
- Or press the power button for more than 2 second and a pop-up screen menu will appear then tap  screenshot.



About Android File Application

The Android File Manager app helps to manage, delete, print, shares and transfer files between the mobile storage and a computer.





To access pictures, videos, screenshots, audios, downloads, and mobile internal / external storage, go to application drawer.

- Tap  file application from the application drawer.
- Tap  3 lines menu and choose one of the following options.
- Tap  Image Icon for pictures and screenshots.
 - ❖ Tap Camera folder for photos.
 - ❖ Tap Screenshots folder for screenshot images.
 - ❖ Tap  Video for recorded videos.
 - ❖ Tap Camera folder.
 - ❖ Tap  Audio for recorded audios.
 - ❖ Tap  for Downloaded items.
 - ❖ Tap  for mobile internal storage folders.
 - ❖ Tap  for mobile external storage folders.

Delete Files





- To delete files from the folders above, press and hold an item or tap  3 dots menu to select all items in the folder.
- Tap  to delete.
- Tap OK to confirm.

Copy and Move Files

- To copy or move files into new location press and hold an item from the folders above or tap  3 dots menu to select all items in the folder.
- Tap  3 dots menu again and choose “Copy to” or “Move to”.
- Tap  3 lines menu and choose from the following options where you want to move or copy the item.
- To create a new folder, tap  3 dots menu.
- Rename the folder.
- Tap Copy or Move to confirm.
- Print File
- Note: To print you must set a printer. See Android Settings → Connected device → Print.
- To print files from the folders above, tap an item once.
- Tap  3 dots menu and tap Print.

Share Files

Note: Make sure both devices Bluetooth are paired. See Connected devices → Bluetooth on this user manual.

- To share files from the folders above, press and hold an item.
- tap  share icon.
- To share via Bluetooth, tap  Bluetooth icon.
- To share via Email, tap  email icon
- For more options hold an item from the folders above.
- Tap  3 dots menu and choose from the following options and follow on-screen instructions.

About Imager Engine / Barcode Reader

Elo mobile computer uses a sub-miniature imager engine. The sub-miniature area imager engine optimized for bar code reading. The engine captures digital images of a bar code for transmission to a decoder to decode a 1D or 2D bar code of any format supported by the decoding software. The imager engine includes an LED aiming system, and an LED illumination system.

- [Aiming System](#)

A 610 nm LED is used to generate a circular aiming pattern which indicates the center of the imager's field of view.

- [Aiming Error](#)

The aiming pattern is rotated by 2° relative to the imaging axis in the horizontal plane to minimize parallax between the aiming axis and the imaging axis at 195 mm (7.7 in.) from the engine. See *Aiming Element* below.

- [Aiming Control](#)

Can capture images with both the aiming subsystem turned on during exposure (the image of the aiming pattern is visible in the digital image) or off. If the aiming system is turned off during exposure, brightness of the aiming pattern decreases as exposure increases. The aiming subsystem can also be turned off completely. Elo recommends shutting aiming off three frames prior to capturing documents to prevent the aiming

- [Illumination System](#)

The illumination system consists of one red LED and a sophisticated drive system that allows image capture and decoding throughout a full range of lighting conditions (total darkness to full sunlight).

- [Illumination Control](#)

The imager engine can capture images with the illumination subsystem turned on or off. LED illumination can be turned off when taking images of documents printed on semi-glossy or glossy paper or on a substrate with security marks. In this case, ensure ambient illumination provides a minimum of 30fcd on the document surface.

Imager Aiming Element specifications

Skew, Roll, and Pitch

Measured on a 20 mil Code 39 symbol at distance of 5 inches. Tolerance for skew and pitch is reduced at extreme ends of the working range.

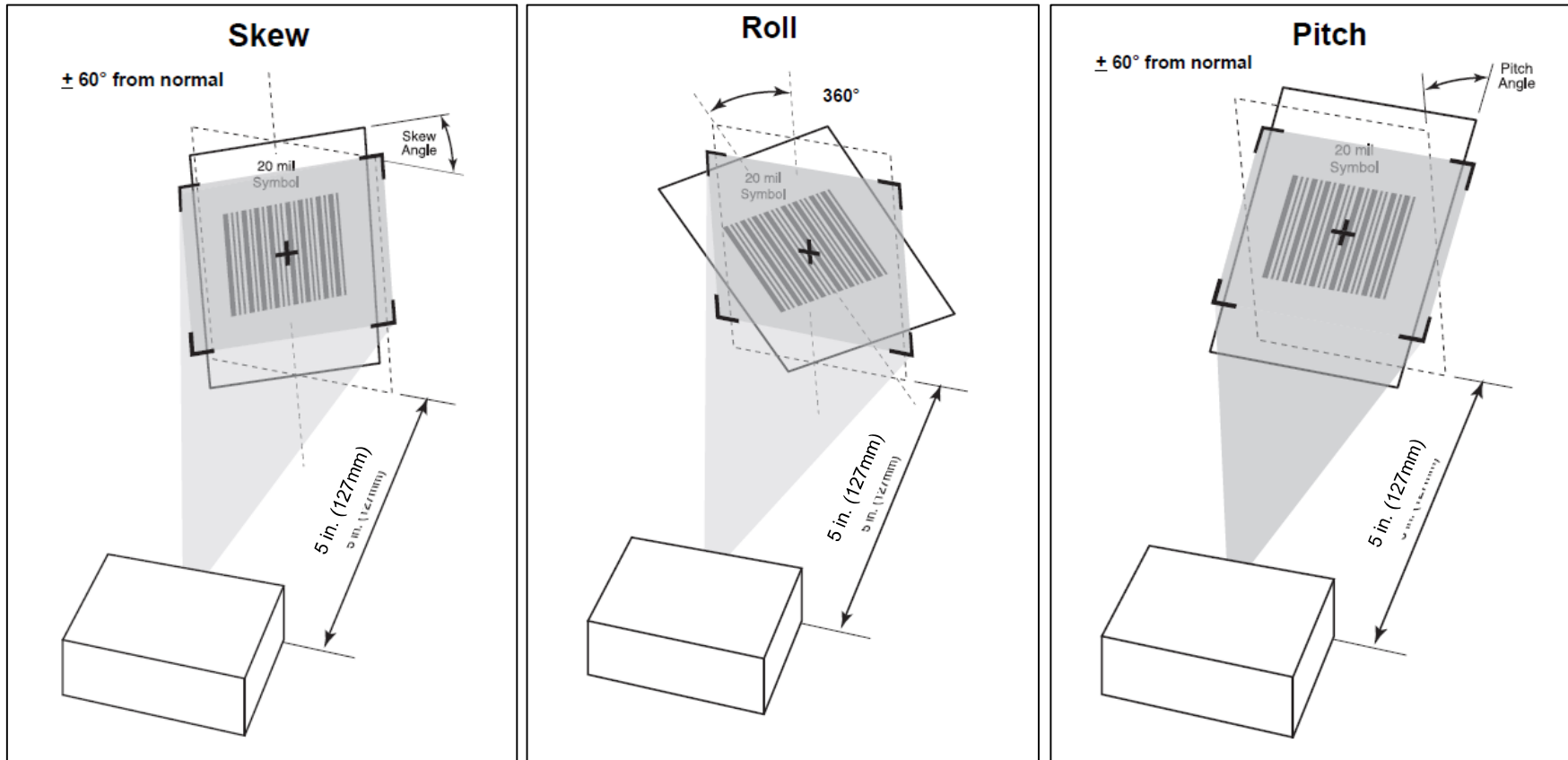

Imager Technical Specification

Item	Description
Optical Resolutions	5.0 mil (Code 39), 5.0 mil (PDF417)
Specular Dead Zone <ul style="list-style-type: none"> • Illumination On • Illumination Off 	Up to 20° depending on target distance and substrate glossiness None
Ambient Light Immunity (Sunlight)	10000 ft. candles (107,639 lux)
Imaging Sensor <ul style="list-style-type: none"> • Image Resolution • Field of View (FOV) 	1280 horizontal X 800 vertical pixels 42.0° horizontal, 28.0° vertical
Focusing Distance from Front of Engine	194mm / 7.64 inches
LED Aiming Element <ul style="list-style-type: none"> • LED • Aiming Dot Brightness Level 	610nm 130fcd nominal
Illumination System <ul style="list-style-type: none"> • LED • Pattern Angle 	Hyper Red 660nm 50.3° horizontal, 32.0° vertical at 50% intensity
Minimum Bar Code Print Contrast	20%

Imager Decode Ranges

- Trigger Level Mode Working Decode Ranges

Barcode Type	Near Distance Typical	Far Distance Typical
4 mil Code 39	3.3 in / 8.4 cm	8.8 in / 22.4 cm
5 mil Code 128	2.8 in / 7.1 cm	8.2 in / 20.8 cm
5 mil Code 39	2.0 in / 5.08 cm	13.5 in / 34.3 cm
5mil PDF417	3.1 in / 7.9 cm	8.4 in / 21.3 cm
10 mil Data Matrix	2.9 in / 7.4 cm	10.1 in / 25.7 cm
100% UPCA	1.8 in / 4.6 cm*	26.0 in / 66.0 cm
20.0mil Code 39	2.0 in / 5.08 cm*	30.0 in / 76.2 cm
20 mil QR Code	1.2 in / 3.0 cm	16.7 in / 42.4 cm

*Limited by width of bar code in field of view.

Note: Photographic quality bar code at 15° tilt pitch angle under 30fc/d ambient illumination.

- Presentation Mode Working Decode Ranges (Swipe Speed: 30 in/sec)

Barcode Type	Near Distance Typical	Far Distance Typical
100% UPCA	2.0 in / 5.08 cm	8.0 in / 20.3 cm
100% UPCA	2.0 in / 5.08 cm	8.0 in / 20.3 cm

User Preferences – Parameters

Note: For additional settings and configurations, please refer on “Software Decode SDK For Android Developer Guide”.

Parameter	Parameter Number	Default	Commands
Trigger Mode	138	Level	0 = Level 7 = Presentation Mode 9 = Auto Aim
Picklist Mode	402	Disabled Always	0 = Disabled Always 2 = Enabled Always
Decode Session Timeout	136	9.9 Sec	0.5 to 9.9 seconds. To set 0.5 seconds, enter the value 5. To set 9.9 seconds, enter the value 99.
Timeout Between Decodes, Same Symbol	137	0.6 Sec	0.0 to 9.9 seconds. To set 0.6 seconds, enter the value 6. To set 9.9 seconds, enter the value 99.
Transmit Code ID Character	45	None	0 = None 1 = AIM Code ID Character 2 = Symbol Code ID Character
Transmit “No Read” Message	94	Disable	0 = Disable 1 = Enable
Fuzzy 1D Processing 514 Enable 4-5	514	Enable	0 = Disable 1 = Enable
Mobile Phone/Display Mode	716	Disable	0 = Disable 1 = Enable
Multi Decode Mode	900	Disable	0 = Disable 1 = Enable
Bar Codes to Read	902	1	0 - 10
Full Read Mode	901	1	0 - Generate a decode event after one or more bar codes are decoded. 1 - Only generate the callback to on Decode Complete () when at least the number of bar codes set in Bar Codes to Read are decoded.

Imager Preferences – Parameters

Note: For additional settings and configurations, please refer on “Software Decode SDK For Android Developer Guide”.

Parameter	Parameter Number	Default	Commands
Illumination Power Level	764	10	0 - 10
Decoding Illumination	298	Enable	0 = Disable 1 = Enable
Decode Aiming Pattern	306	Enable	0 = Disable 1 = Enable
Hands-free Decode Aiming Pattern	590	Enable	0 = Disable 1 = Enable
Image Capture Illumination	361	Enable	0 = Disable 1 = Enable
Frame Rate	674	0 (Auto)	0 = Auto 1 = 60 fps 2 = 30 fps 3 = 15 fps 4 = 10 fps 5 = 55 fps 6 = 50 fps 7 = 45 fps 8 = 40 fps
Exposure Time	567	0	0 to 960
Motion Illumination	762	Enable	0 = Disable 1 = Enable
Snapshot Mode Timeout	323	0 (30 seconds)	0 = 30 seconds 1 = 60 seconds 2 = 90 seconds
Snapshot Aiming Pattern	300	Disable	0 = Disable 1 = Enable
Image Cropping	301	Disable	0 = Disable 1 = Enable
Crop to Pixel Addresses	315; 316 317; 318	0 top, 0 left, 479 bottom, 751 right	Value Range (0,0) to (1279, 799) Column Numbering 0 to 1279 Row Numbering 0 to 799
Image Resolution	302	Full	0 Full - 1280 x 800 1 1/2 -640 x 400 3 1/4 -640 x 400
Image File Format Selection	304	JPEG	1 - JPEG File Format 3 - BMP File Format 4 - TIFF File Format

JPEG Image Options	299	1 (Quality Value)	1 - Quality Value 0 - Size Value
JPEG Quality Value	305	65	5 to 100 100 represents the highest quality image.
Image Enhancement	564	Off	0 = Off 1 = Low 2 = Medium 3 = High
Bits per Pixel (BPP)	303	8 BPP	2 = 8 BPP to assign 1 of 256 levels of grey to each pixel 0 = 1 BPP for a black and white image 1 = 4 BPP to assign 1 of 16 levels of grey to each pixel
Signature Capture	93	Disable	0 = Disable 1 = Enable
Signature Capture Image File Format Selection	313	JPEG	1 = JPEG 3 = BMP 4 = TIFF
Signature Capture Bits per Pixel (BPP)	314	8 BPP	2 = 8 BPP 0 = 1 BPP 1 = 4 BPP to
Signature Capture Width	366	400	001 to 1280 decimal
Signature Capture Height	367	100	001 to 800 decimal
Signature Capture JPEG Quality	421	65	005 to 100 100 represents the highest quality image.
Video View Finder	324	Disable	0 = Disable 1 = Enable
Video Scaling	761	2	0 = Full Resolution - 1280 x 800 1 = 1/2 Resolution 2 = 1/3 Resolution 3 = 1/4 Resolution
Retrieve Last Decoded Image	905	Disable	0 = Disable 1 = Enable

Symbology Parameter

Note: For additional settings and configurations, please refer on “Software Decode SDK For Android Developer Guide”.

1D Symbologies	Parameter Number	Commands * Default
UPC-A	1	0x00 = Disable 0x01 = Enable*
UPC-E	2	0x00 = Disable 0x01 = Enable*
UPC-E1	12	0x00 = Disable* 0x01 = Enable
EAN-8/JAN-8	4	0x00 = Disable 0x01 = Enable*
EAN-13/JAN-13	3	0x00 = Disable 0x01 = Enable*
Bookland EAN	83	0x00 = Disable* 0x01 = Enable
UCC Coupon Extended Code	85	0x00 = Disable* 0x01 = Enable
ISSN EAN	617	0x00 = Disable* 0x01 = Enable
Code 128	8	0x00 = Disable 0x01 = Enable*
GS1-128	14	0x00 = Disable 0x01 = Enable*
ISBT 128	84	0x00 = Disable 0x01 = Enable*
Code 39	0	0x00 = Disable 0x01 = Enable*
Triptic Code 39	13	0x00 = Disable* 0x01 = Enable
Code 32	231	0x00 = Disable* 0x01 = Enable
Code 93	9	0x00 = Disable* 0x01 = Enable

Code 11	10	0x00 = Disable* 0x01 = Enable
Interleaved 2 of 5	6	0x00 = Disable 0x01 = Enable*
Codabar	7	0x00 = Disable* 0x01 = Enable
MSI	11	0x00 = Disable* 0x01 = Enable
Chinese 2 of 5	408	0x00 = Disable* 0x01 = Enable
Korean 3 of 5	581	0x00 = Disable* 0x01 = Enable
Matrix 2 of 5	618	0x00 = Disable* 0x01 = Enable
Inverse 1D	586	0 - Regular Only* 1 - Inverse Only 2 - Inverse Autodetect
GS1 DataBar	338	0x00 = Disable 0x01 = Enable*
Composite CC-C	341	0x00 = Disable* 0x01 = Enable
Composite CC-A/B	342	0x00 = Disable* 0x01 = Enable
Composite TLC-39	371	0x00 = Disable* 0x01 = Enable

Postal Symbolologies	Parameter	Commands * Default
US Postnet	89	0x00 = Disable 0x01 = Enable*
US Planet	90	0x00 = Disable 0x01 = Enable*
UK Postal	91	0x00 = Disable 0x01 = Enable*
Japan Postal	290	0x00 = Disable 0x01 = Enable*
Australian Postal	291	0x00 = Disable 0x01 = Enable*
Netherland KIX code	326	0x00 = Disable 0x01 = Enable*
USPS 4CB/One Conde Intelligent Mail	592	0x00 = Disable* 0x01 = Enable
UPU FICS Postal	611	0x00 = Disable* 0x01 = Enable

2D Symbologies	Parameter Numbers	Commands * Default
PDF417	15	0x00 = Disable 0x01 = Enable*
Micro PDF417	227	0x00 = Disable* 0x01 = Enable
Data Matrix	292	0x00 = Disable 0x01 = Enable*
Data Matrix Inverse	588	0 - Regular Only* 1 - Inverse Only 2 - Inverse Autodetect
GS1 Data Matrix	1336	0x00 = Disable* 0x01 = Enable
Maxicode	294	0x00 = Disable 0x01 = Enable*
QR Code	293	0x00 = Disable 0x01 = Enable*
Micro QR Code	573	0x00 = Disable 0x01 = Enable*
Aztec	574	0x00 = Disable 0x01 = Enable*
Aztec Inverse	589	0 - Regular Only* 1 - Inverse Only 2 - Inverse Autodetect
Han Xin	1167	0x00 = Disable* 0x01 = Enable
Han Xin Inverse	1168	0 - Regular Only 1 - Inverse Only 2 - Inverse Autodetect

Barcode Scanning using Barcode Reader

To test the functionality of the scanner, open (**BCR Demo app**) from application drawer. The Apps will allow to enable the imager, decode the barcode data, and display the barcode content.

Note: To set up the “**Function buttons**” as a barcode “Trigger”, go to **Android**  **Settings** → **Key Remap**.

- To start scanning, aim the imager at a barcode.
- Press once either of the trigger button
- To cancel the scanning, press trigger button once again.
- During scan by default the aimer and illumination will turn ON to assist in aiming.
- When the barcode is successfully decoded, by default a beep sound will turn ON, function LED will luminate blue, display the barcode content and a picture of the barcode.

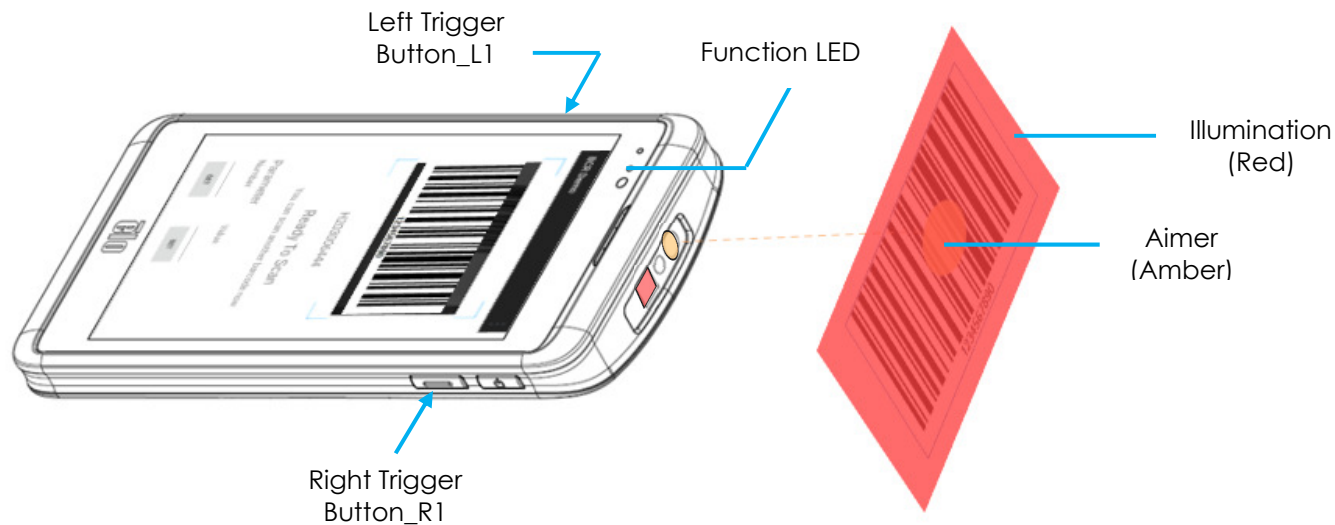

Setting for User, Imaging and Symbology Parameters

To set the parameter of User, Imaging and Symbology run the **(BCR Demo app)** from the application drawer.
For reference, see imaging and symbology parameters on this user manual.

Example:

To set “Decoding illumination” parameter to Disable:

- Enter the code of the Parameter for Decoding Illumination (**298**). See parameters on this manual for reference.
- Enter the command (**0**) for disable under “Value”.
- Tap SET to execute parameter.
- When successfully programmed, **(Set parameter 298 to 0 Done!)** will appear.

Parameter	Parameter Number	Default	Commands
Decoding Illumination	298	Enable	0 = Disable 1 = Enable

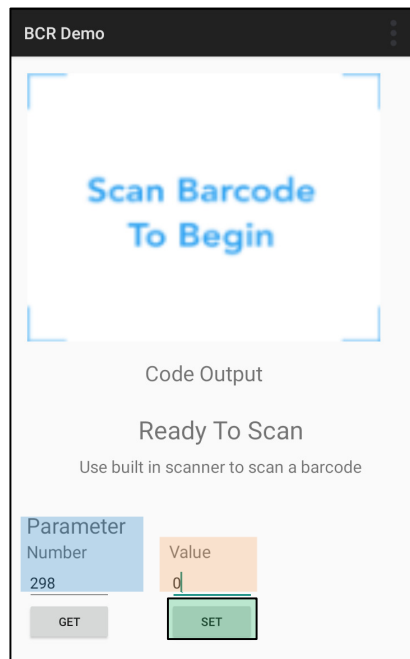

Getting User, Imaging and Symbology Parameters

To get the parameter of User, Imaging and Symbology run the **(BCR Demo app)** in the application drawer. For reference, see imaging and symbology parameters on this user manual.

Example:

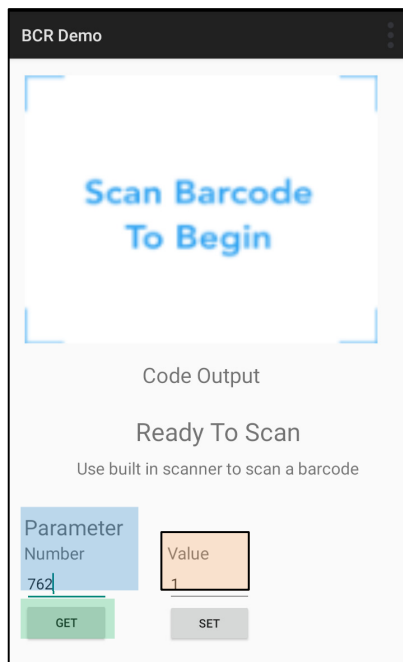

To get the parameter of “Motion illumination”:

- Enter the code of parameter (**762**) for “Motion Illumination” and tap “**GET**”.
- Check the parameter value under “**Value**”, should show as “**1**”.



Scanning QR code with Integrated Camera

To test the functionality of the camera for reading QR code, open (Camera / Snapdragon app) from application drawer. The App will allow to enable the camera as imager, decode the barcode data, and display the barcode content.

- Open the camera application (Snapdragon).
- Take a photo of the following QR code below.
- Tap the photo gallery at lower left corner.
- Below the QR code picture, tap the QR icon .
- Tap the content of the QR code 
 - After tapping the content (www.elotouch.com), the website will open.



Reading NFC Tag

To test the functionality of the NFC, set the NFC to enable, go to Android Setting  → Connected Device → Connection preferences → NFC. Load a 3rd party NCF application e.g. TagWriter.

- To start reading NFC tag, open (TagWriter APK) or depending which application is installed
- Tap "Read Tags".
- When device is ready to read, place the card and touch the back of the device.
- When the NFC card is read by default a beep sound will turn ON and display the NFC content.

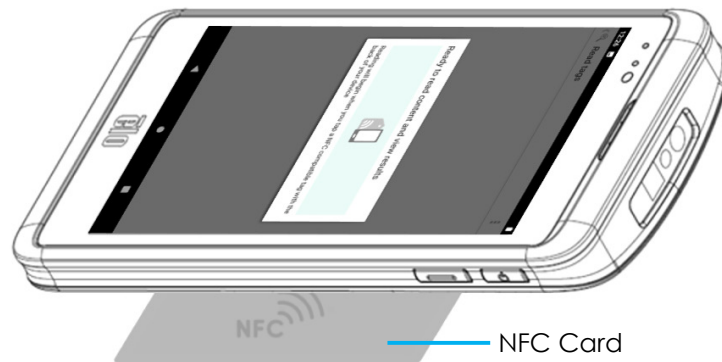

About Cellular Phone - (LTE/4G/3G) (M50C WWAN SKU only)

The cellular phone is limited to a 3rd party calling (Skype, Line, WeChat). No voice calls.

Supported Carriers Bands



The following bands supported on AT&T, Verizon, T-Mobile, and Vodafone networks.

	US	EU
WCDMA	B2-1800 B4-1700 B5-800	B1-1900 B8-900
LTE-FDD	B2(10M)-1800 B4(10M)-1700 B12(5M)-700 B66(10M)-1700	B1(10M)-1900 B3(10M)-1700 B7(10M)-2600 B8(10M)-900 B20(10M)-800

About Android Debug Bridge (ADB) control

Elo Handheld computer device supports debugging via Wi-Fi/Ethernet or using the USB cable, Type C to Type A cable.

Set Mobile computer to (Developer)

- Enter Android  Settings → About Phone → Build Number.
- Tap Build Number 7 times to enter developer mode.
- Go back to the  Settings → System → Advanced and you will see “**Developer Options**”.
- From Developer options on- screen display, enable the option called “**USB debugging**”.

To connect via Wi-Fi

Ensure that your computer is online and not behind a firewall.

- Find the IP address (by going to  **Settings** → **Network & Internet** → **Wi-Fi** → Tap the active **connection** → **Advanced** → **IP Address**.
- On your host computer, use the command ADB connect <IP address> to be able to perform ADB actions.

To connect via USB, perform the following steps

- Ensure the USB cable is not connected to the mobile computer.
- From the settings, enter Developers Options
- Turn on the “Enable USB Debugging” option
- Plug USB cable (type C) side into the computer device and (type A) to host PC.
- In the host PC, input “ADB devices” to check if the Elo Handheld Computer serial number shows up. If it is there, then you have connected successfully.

About Elo Mobile Factory Full Reset

A full factory reset should only be performed if all other recovery methods have failed and all other troubleshooting options. Performing a full factory reset results in loss of data. This option will recover the original factory image state by erasing all data in the main storage on the Elo handheld computer.

Note: Performing a factory reset on **Android bootloader menu**, if you added a Google Account to Elo handheld Computer make sure you have your Google credential (Username and password) associated with the Elo handheld computer. If you don't have it you will not be able to use the device after reset. This is a security measure that prevents unauthorized users from using the device if they do a factory reset on the Android bootloader menu.

To Reset

- Enter Android  **Settings** → **System** → **Advanced** → **Reset Options**.
- Tap **Erase all data**.
- Under **Erase all data (factory reset)** or **Erase all data (factory reset to EloVidew Mode)**, tap **Erase all data**.
- Under **Erase all data?**, tap **Erase all data**.
- When successfully done, the device will auto-reboot.

Section 5: Technical Support and Maintenance

Technical Assistance

Technical Specifications

visit www.elotouch.com/products
for technical specifications for this device

Support

visit www.elotouch.com/support for technical support

Refer to last page for worldwide technical support phone numbers.

Elo Mobile Computer Care and Handling

The following tips will help maintain optimal performance of your Elo Mobile Computer:

- To prepare for cleaning the touchscreen, power down the device (if possible), or ensure your on-screen software can tolerate false touches while you clean.
- Do not get liquids inside the unit. Do not spray the Elo product directly. Instead, use wet wipes, a sprayed cloth or a dampened cloth with the excess moisture squeezed off.
- Select only non-abrasive cleaning wipes or cloths to avoid scratching touchscreens.
- Avoid highly concentrated alcohol (> 70%), non-diluted bleach or ammonia solutions, as these may cause discoloration.
- Wipe the surfaces with the appropriate wipes or cloths and approved cleaning products and allow them to dry.
- For additional cleaning methods, recommended cleaning and disinfectant solutions, please visit <https://www.elotouch.com/support/technical-support/cleaning>

Section 6: Regulatory Information

Electrical Safety Information

Compliance is required with respect to the voltage, frequency, and current requirements indicated on the manufacturer's label. Connection to a different power source than those specified herein will likely result in improper operation, damage to the equipment, or pose a fire hazard if the limitations are not followed.

There are no operator serviceable parts inside this equipment. There are hazardous voltages generated by this equipment which constitute a safety hazard. Service should be provided only by a qualified service technician.

Contact a qualified electrician or the manufacturer if there are questions about the installation prior to connecting the equipment to mains power.

Emissions and Immunity Information

Notice to Users in the United States:

FCC

§ 15.19 This device complies with part 15 of the FCC Rules. Operation is subject to the following two conditions: (1) This device may not cause harmful interference, and (2) this device must accept any interference received, including interference that may cause undesired operation of the device.

§ 15.21 Changes or modifications not expressly approved by the party responsible for compliance could void the user's authority to operate the equipment.

§ 15.105 This equipment has been tested and found to comply with the limits for a Class B digital device, pursuant to part 15 of the FCC Rules. These limits are designed to provide reasonable protection against harmful interference in a residential installation. This equipment generates, uses, and can radiate radio frequency energy and, if not installed and used in accordance with the instructions, may cause harmful interference to radio communications. However, there is no guarantee that interference will not occur in a particular installation. If this equipment does cause harmful interference to radio or television reception, which can be determined by turning the equipment off and on, the user is encouraged to try to correct the interference by one or more of the following measures:

- Reorient or relocate the receiving antenna.
- Increase the separation between the equipment and receiver.
- Connect the equipment into an outlet on a circuit different from that to which the receiver is connected.
- Consult the dealer or an experienced radio/TV technician for help.

This equipment should be installed and operated to ensure a minimum of 20 cm spacing to any person.

Notice to Users in Canada for IC compliance: This equipment complies with the Class B limits for radio noise emissions from digital apparatus as established by the Radio Interference Regulations of Industrial Canada.

CAN ICES3 (B)/NMB3(B)

This device contains license-exempt transmitter(s)/receiver(s) that comply with Innovation, Science and Economic Development Canada's license-exempt RSS(s). Operation is subject to the following two conditions:

- (1) This device may not cause interference.
- (2) This device must accept any interference, including interference that may cause undesired operation of the device.

L'émetteur/récepteur exempt de licence contenu dans le présent appareil est conforme aux CNR d'Innovation, Sciences et Développement économique Canada applicables aux appareils radio exempts de licence. L'exploitation est autorisée aux deux conditions suivantes:

- (1) L'appareil ne doit pas produire de brouillage;
- (2) L'appareil doit accepter tout brouillage radioélectrique subi, même si le brouillage est susceptible d'en compromettre le fonctionnement.

ISED RF Exposure Statement

This device complies with ISED RSS-102 RF exposure limits set forth for an uncontrolled environment. In order to avoid the possibility of exceeding the IC RSS-102 RF exposure limits, human proximity to the antenna shall not be less than 20cm (8 inches) during normal operation.

Cet appareil est conforme aux limites d'exposition aux rayonnements de la CNR-102 définies pour un environnement non contrôlé. Afin d'éviter la possibilité de dépasser les limites d'exposition aux fréquences radio de la CNR-102, la proximité humaine à l'antenne ne doit pas être inférieure à 20 cm (8 pouces) pendant le fonctionnement normal.

Notice to Users in the European Union: Use only the provided power cords and interconnecting cabling provided with the equipment. Substitution of provided cords and cabling may compromise electrical safety or CE Mark Certification for emissions or immunity as required by the following standards:

This Information Technology Equipment (ITE) is required to have a CE Mark on the Manufacturer's label which means that the equipment has been tested to the following Directives and Standards: This equipment has been tested to the requirements for the CE Mark as required by EMC Directive 2014/30/ EU as indicated in European Standard EN 55032 Class B and the Low Voltage Directive 2014/35/EU as indicated in European Standard EN 62368-1.

General Information to all Users:

This equipment generates, uses, and can radiate radio frequency energy. If not installed and used according to this manual the equipment may cause interference with radio and television communications. There is, however, no guarantee that interference will not occur in any particular installation due to site-specific factors.

1. In order to meet emission and immunity requirements, the user must observe the following:
 - a. Use only the provided I/O cables to connect this digital device with any computer.
 - b. To ensure compliance, use only the provided manufacturer's approved line cord.

- c. The user is cautioned that changes or modifications to the equipment not expressly approved by the party responsible for compliance could void the user's authority to operate the equipment.
2. If this equipment appears to cause interference with radio or television reception, or any other device:
- a. Verify as an emission source by turning the equipment off and on. If you determine that this equipment is causing the interference, try to correct the interference by using one or more of the following measures:
 - i. Move the digital device away from the affected receiver.
 - ii. Reposition (turn) the digital device with respect to the affected receiver.
 - iii. Reorient the affected receiver's antenna.
 - iv. Plug the digital device into a different AC outlet so the digital device and the receiver are on different branch circuits.
 - v. Disconnect and remove any I/O cables that the digital device does not use. (Unterminated I/O cables are a potential source of high RF emission levels.)
 - vi. Plug the digital device into only a grounded outlet receptacle. Do not use AC adapter plugs. (Removing or cutting the line cord ground may increase RF emission levels and may also present a lethal shock hazard to the user.)

If you need additional help, consult your dealer, manufacturer, or an experienced radio or television technician.

Radio Equipment Directive

Elo hereby declares that the radio equipment type, Elo handheld Computer, is in compliance with Directive 2014/53/EU. The full text of the EU Declaration of Conformity is available at the following internet address: www.elotouch.com

This device is designed and intended for indoor use only.

	AT	BE	BG	HR	CY	CZ	DK
	EE	FI	FR	DE	EL	HU	IE
	IT	LV	LT	LU	MT	NL	PL
	PT	RO	SK	SI	ES	SE	UK

This device is restricted to indoor use

Operation frequency and radio-frequency power are listed as below:

- WLAN 802.11b/g/n/ac
 - 2400 - 2483.5MHz < 17 dBm EIRP
 - 5150 - 5250MHz < 18 dBm EIRP
- BT 2400-2483.5MHz < 11 dBm EIRP

ECC/DEC/ (04)08:

The use of the frequency band 5 150-5 350 MHz is restricted to indoor operation because of the protection requirements of satellite services

EC R&TTE Directive EU Directive 2014/53/EU of the European Parliament and of the Council of 16 April 2014 on the harmonization of the laws of the Member States relating to the making available on the market of radio equipment and repealing Directive 1999/5/EC Text with EEA relevance.



Identification mark the relevant technical documentation is held at: Elo Touch Solutions, Inc. 670 N. McCarthy Boulevard Suite 100 Milpitas, CA 95035 USA

USA FCC ID: ~~TBD~~

Canada IC ID: ~~TBD~~

Agency Certifications

The following certifications and marks have been issued or declared for this peripheral:

- UL, FCC (US) – Class B
- cUL, IC (Canada)
- CB (International Safety)
- CE (Europe) – Class B
- VCCI (Japan)
- RCM (Australia)
- China RoHS

Waste Electrical & Electronic Equipment Directive (WEEE)



This product should not be disposed of with household waste. It should be deposited at a facility that enables recovery and recycling. Elo has put in place recycling arrangements in certain parts of the world. For information on how you can access these arrangements, please visit www.elotouch.com/e-waste-recycling-program/.



Replace the battery with same type only. Improper replacement of battery may cause in risk of burns, fire, and explosions. Dispose the battery according to local regulations. Risk of fire and burns if properly handled. Do not open and crush, heat above 60° C / 140° F or incinerate. If there is a serious swelling of the battery, do not continue using.

Section 7: Warranty Information

For warranty information, go to <http://support.elotouch.com/warranty/>

www.elotouch.com

Visit our website for the latest

- Product Information
- Specifications
- Upcoming Events
- Press Releases
- Software Drivers

To find out more about our extensive range of Elo touch solutions, go to www.elotouch.com, or call the office nearest you.

Google, Android, Google Play and YouTube are trademarks of Google LLC.

North America

Tel +1 408 597 8000
Fax +1 408 597 8001
elosales.na@elotouch.com

Europe

Tel +32 (0)16 70 45 00
Fax +32 (0)16 70 45 49
elosales@elotouch.com

Asia-Pacific

Tel +86 (21) 3329 1385
Fax +86 (21) 3329 1400
www.elotouch.com.cn

Latin America

Tel +52 55 2281-6958
elosales.latam@elotouch.com

