

## GS-5654LX, GS-5654PLX V2

# Quick Installation Guide

04-2023 / V1.1

---

### **Edimax Technology Co., Ltd.**

No. 278, Xinhu 1st Rd., Neihu Dist., Taipei City, Taiwan

Email: [support@edimax.com.tw](mailto:support@edimax.com.tw)

---

### **Edimax Technology Europe B.V.**

Fijenhof 2, 5652 AE Eindhoven, The Netherlands

Email: [support@edimax.nl](mailto:support@edimax.nl)

---

### **Edimax Computer Company**

530 Technology Drive Suite 100, Irvine, CA 92618, USA

Email: [support@edimax.us](mailto:support@edimax.us)

# **Contents**

---

<b><i>I. Product Information</i></b> .....	<b>1</b>
I-1. Package Content .....	1
I-2. Hardware Overview .....	2
I-3. LED Status.....	3
<b><i>II. Installation</i></b> .....	<b>5</b>
II-1. Physically Setup.....	5
II-2. Connection .....	6
<b><i>III. Web-based Configuration Utility</i></b> .....	<b>8</b>
<b><i>IV. More Information</i></b> .....	<b>10</b>
<b><i>V. Safety Instructions</i></b> .....	<b>10</b>

# I. Product Information

---

- **GS-5654LX:** 54-Port Gigabit Web Smart Switch with 6 SFP+ 10G Ports
- **GS-5654PLX V2:** 54-Port Gigabit PoE+ Long Range Web Smart Switch with 6 SFP+ 10G Ports

## I-1. Package Content

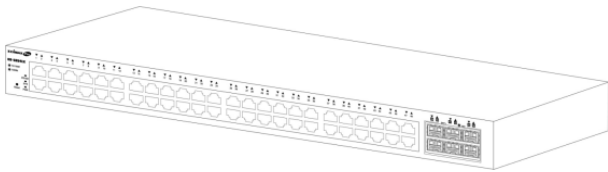

**GS-5654LX**

or

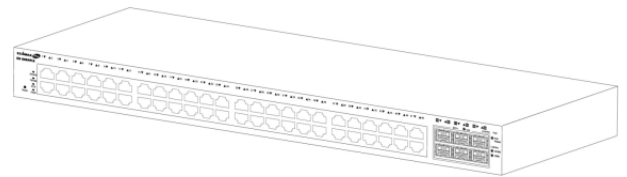

**GS-5654PLX V2**



**Quick Installation  
Guide**



**Power Cord**

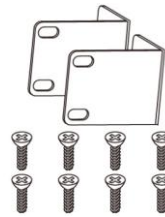

**Rack-Mount Kit**



**Console Cable**

## I-2. Hardware Overview

### GS-5654LX:

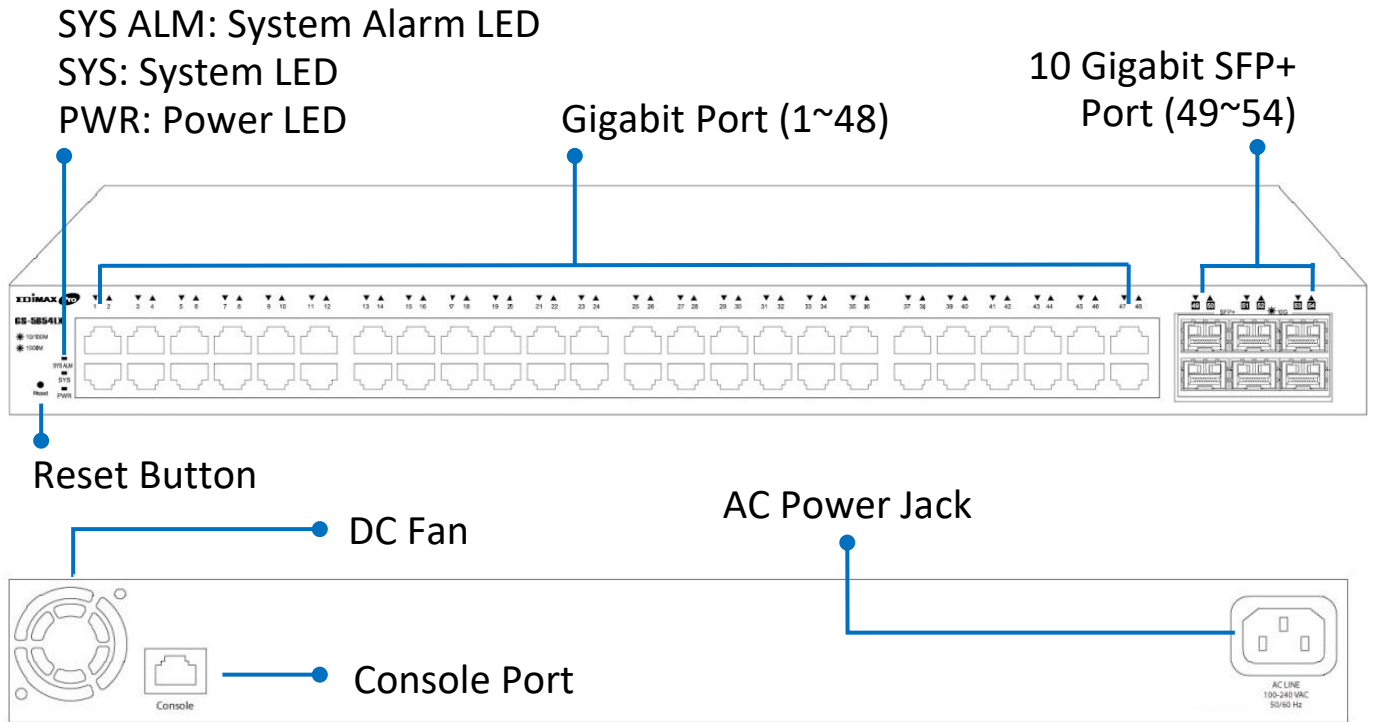

### GS-5654PLX V2:

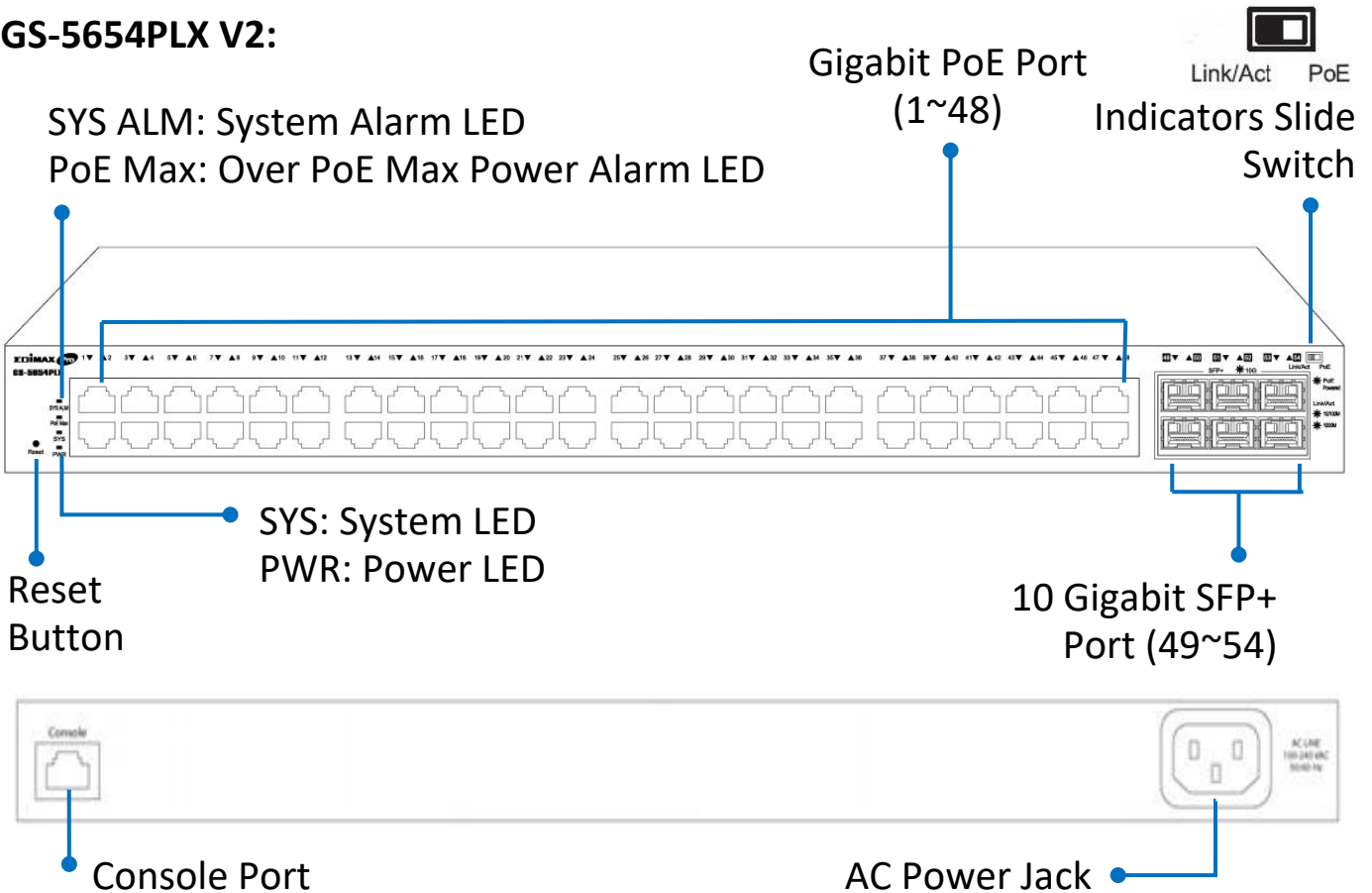



### I-3. LED Status

#### GS-5654LX

Function	Color	Status	Description
PWR	Green	On	Power on
		Off	Power off
SYS	Green	On	Power on
		Blinking	System is booting up
		Off	Power off
SYS ALM	Red	On	System failure
		Off	Device in good condition
Link/Act (1~48 Port)	Green	On	Link at 1000Mbps
		Blinking	Sending or receiving data
		Off	Port disconnected or link fail
	Amber	On	Link at 10/100Mbps
		Blinking	Sending or receiving data
		Off	Port disconnected or link fail
10 G SFP+ Port (49-54 Port)	Blue	On	Link at 10Gbps
		Blinking	Sending or receiving data
		Off	Port disconnected or link fail
	Green	On	Link at 1Gbps
		Blinking	Sending or receiving data
		Off	Port disconnected or link fail

## GS-5654PLX V2

Function	Color	Status	Description
PWR	Green	On	Power on
		Off	Power off
SYS	Green	On	Power on
		Blinking	System is booting up
		Off	Power off
SYS ALM	Red	On	System failure (Overheat, wrong voltage)
		Off	Device in good condition
PoE Max	Green	On	Over PoE max. power
		Off	Not over PoE max power
10 G SFP+ Port (Port 49~54)	Blue	On	Link at 10Gbps
		Blinking	Sending or receiving data
		Off	Port disconnected or link fail
	Green	On	Link at 1000Mbps
		Blinking	Sending or receiving data
		Off	Port disconnected or link fail
Link/Act or PoE Indicators Slide Switch  Link/Act PoE	Link/Act (Left) 		Show Link/Act network connection status (Port 1 ~48)
	PoE (Right) 		Show PoE connection status (Port 1~48)
Link/Act (Left)	Green	On	Link at 1000Mbps
		Blinking	Sending or receiving data
		Off	Port disconnected or link fail
	Amber	On	Link at 10/100Mbps
		Blinking	Sending or receiving data
		off	Port disconnected or link fail
PoE (Right)	Green	On	Feeding power to PoE devices
		Off	PoE function is not active

## II. Installation

---

Read the following topics and perform the procedures in the correct order. Incorrect installation may cause damage to the product.

### II-1. Physically Setup

There are two ways to physically set up the switch. No matter how you installed the switch, please keep it with good ventilation.

1. **Desktop Placement:** Attach the supplied rubber feet to the recessed areas on the bottom of the switch. Place the switch on a flat surface and keep it with good ventilation.

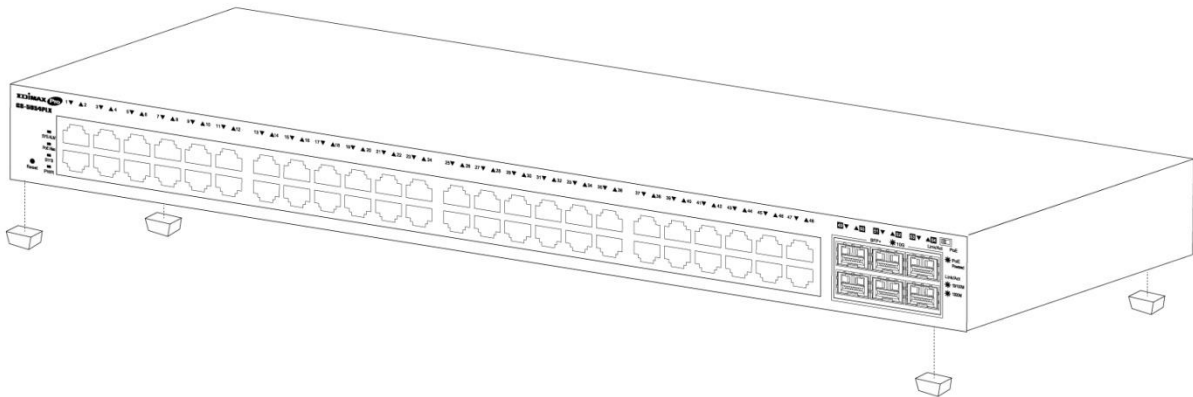

2. **Rack-Mount Installation:** You can mount the switch in any standard size, 19-inch (about 48 cm) wide rack with 1 Rack Unit (1U) of space, which is 1.75 inches (4.45 cm) high.

First, align the mounting brackets with the mounting holes on the switch's side panels and secure the brackets with the screws.

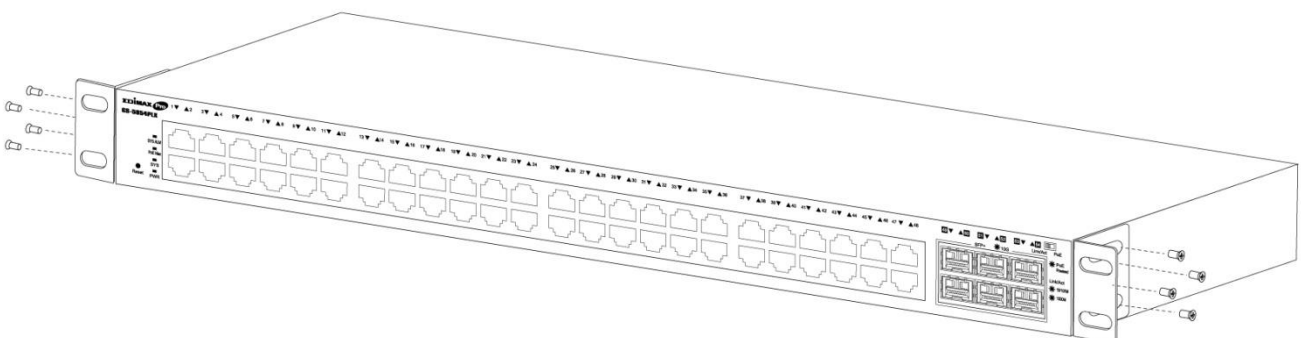

Then secure the switch on the equipment rack and keep it with good ventilation.

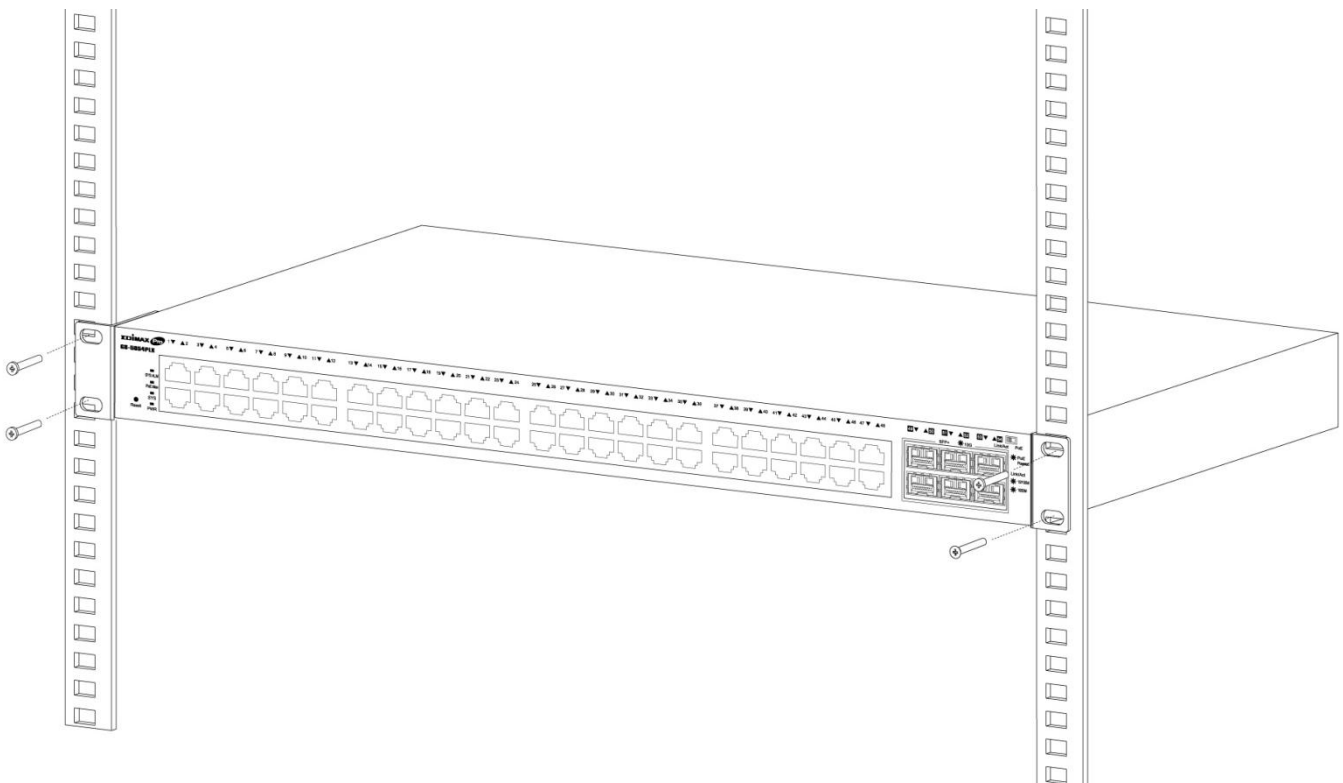

## II-2. Connection

- 1. Power on:** Connect the power cord to the switch and the power outlet. The switch is powered by the 100-240VAC 50/60Hz external high-performance power supply. (Note: Make sure the PWR LED is green.)
- 2. Uplink:** Plug the SFP/SFP+ cable into the SFP/SFP+ slot (Note: Make sure that the LED is blue (SFP+), green or amber (SFP)) or plug the standard Cat5e or above Ethernet cable into the LAN port (Note: Make sure that the LED is green or amber) and connect it to another switch.
- 3. Connect devices:** Plug the standard Cat5e or above Ethernet cable into the LAN port and connect to any networking device with an Ethernet port. (Note: Make sure that the "LAN" Link/Act LED is green or amber.) The hardware installation is complete!



- 4. Connect a computer:** Connect your computer with the switch and get ready for web-based configuration with following “Section III Web-based Configuration Utility”.

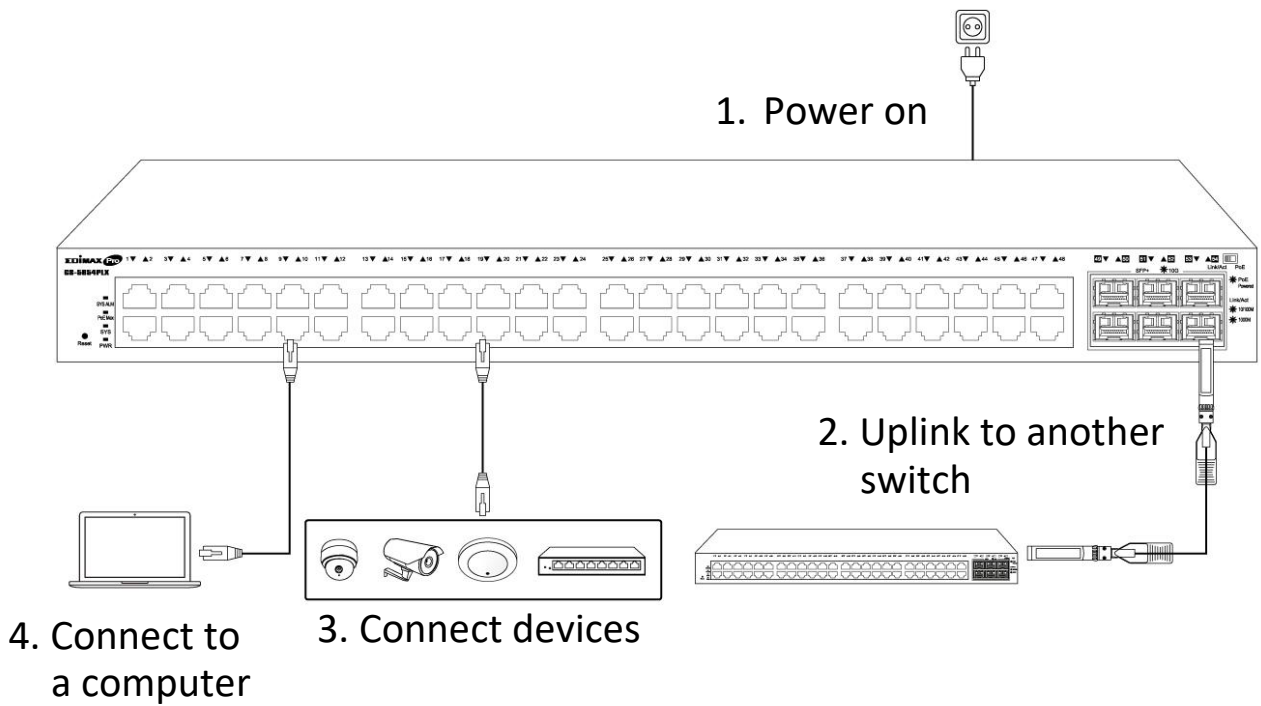

### ***III. Web-based Configuration Utility***

---

This section describes how to navigate the web-based switch configuration utility through web browser. **Be sure to disable any browser pop-up blocker.**

#### **Browser Restrictions**

- If you are using older versions of Internet Explorer, you cannot directly use an IPv6 address to access the device. You can, however, use the DNS (Domain Name System) server to create a domain name that contains the IPv6 address, and then use that domain name in the address bar in place of the IPv6 address.
- If you have multiple IPv6 interfaces on your management station, use the IPv6 global address instead of the IPv6 link local address to access the device from your browser.

#### **Launching the Configuration Utility**

1. Connect your computer with the switch then open a web browser.
2. Enter the IP address of the switch you are configuring in the address bar on the browser (factory default IP address is 192.168.2.1) and then press Enter. Please make sure that your computer's IP address is in the same subnet as this switch. The default IP address is an IP address in the range of 192.168.2.X (X=2-254). You can modify the IP address of your computer if you need.

Default IP	192.168.2.1
Default User Name	admin
Default Password	1234

3. The default username is “admin” and the default password is “1234”.

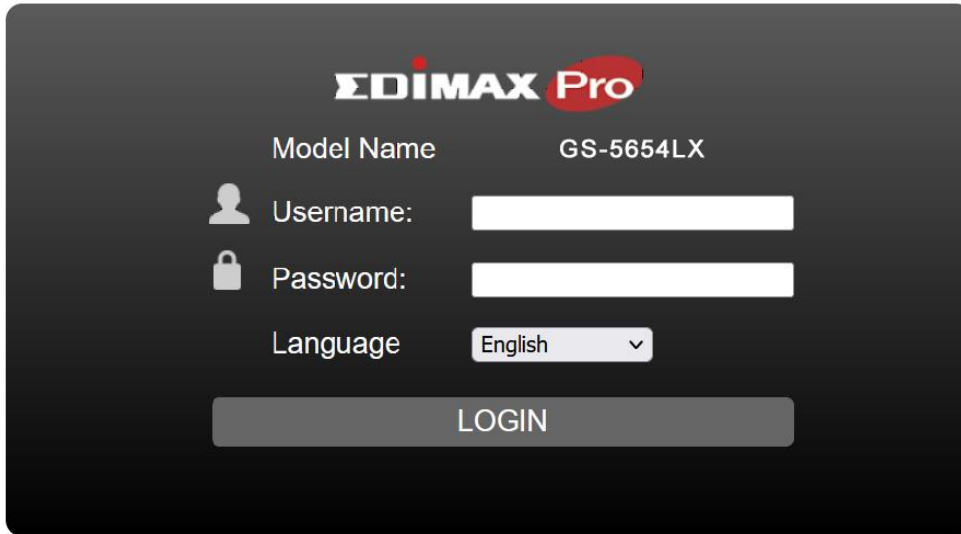

The image shows a login interface for EDIMAX Pro. At the top, the logo "EDIMAX Pro" is displayed. Below it, the "Model Name" is "GS-5654LX". There are two input fields: "Username:" with a person icon and "Password:" with a lock icon. A "Language" dropdown menu is set to "English". A "LOGIN" button is at the bottom.

4. The first time that you log in with the default username and password, you are required to set a new password.

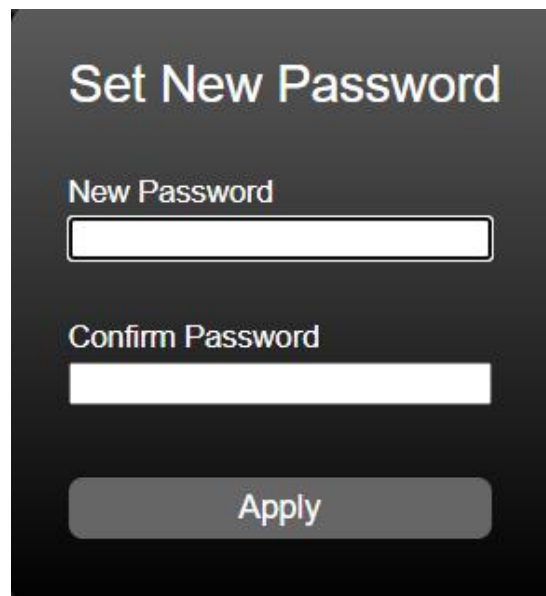

The image shows a "Set New Password" screen. It has two input fields: "New Password" and "Confirm Password". An "Apply" button is at the bottom.

5. For more information about Web-based Configuration Utility, please download User Manual from EDIMAX official website. <https://www.edimax.com/download/>

## IV. More Information

---

For detailed instructions, you can find user manual and all supporting documents from the link below or via the QR code:

<https://www.edimax.com/download/>



Please search the model number to enter the referred page.

### Download

---

To select your product and find related download materials, enter the model number into the search box on the right side or follow the simple steps below:  
\*Feel free to contact us anytime if you need help or if you can't find your product.

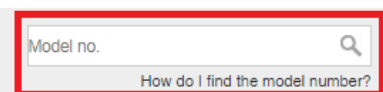

## V. Safety Instructions

---

The following general safety guidelines are provided to help ensure your own personal safety and protect your product from potential damage. Remember to consult the product user instructions for more details.

- This product is designed for indoor use only.
- Static electricity can be harmful to electronic components. Discharge static electricity from your body (i.e. touching grounded bare metal) before touching the product.
- The device contains no user serviceable parts. Do not attempt to service the product and never disassemble the product.
- Do not spill food or liquid on your product and never push any objects into the openings of your product.
- Do not use this product near water, areas with high humidity, or condensation.
- Keep the product away from radiators and other heat sources.
- This device is not designed to be operated by children.
- Always unplug the product from mains power before cleaning and use a dry lint free cloth only.

## **COPYRIGHT**

Copyright © Edimax Technology Co., Ltd. all rights reserved. No part of this publication may be reproduced, transmitted, transcribed, stored in a retrieval system, or translated into any language or computer language, in any form or by any means, electronic, mechanical, magnetic, optical, chemical, manual or otherwise, without the prior written permission from Edimax Technology Co., Ltd.

Edimax Technology Co., Ltd. makes no representations or warranties, either expressed or implied, with respect to the contents hereof and specifically disclaims any warranties, merchantability, or fitness for any particular purpose. Any software described in this manual is sold or licensed as is. Should the programs prove defective following their purchase, the buyer (and not this company, its distributor, or its dealer) assumes the entire cost of all necessary servicing, repair, and any incidental or consequential damages resulting from any defect in the software. Edimax Technology Co., Ltd. reserves the right to revise this publication and to make changes from time to time in the contents hereof without the obligation to notify any person of such revision or changes.

The product you have purchased and the setup screen may appear slightly different from those shown in this QIG. The software and specifications are subject to change without notice. Please visit our website [www.edimax.com](http://www.edimax.com) for updates. All brand and product names mentioned in this manual are trademarks and/or registered trademarks of their respective holders.

## **Federal Communication Commission Interference Statement**

This equipment has been tested and found to comply with the limits for a Class A digital device, pursuant to Part 15 of the FCC Rules. These limits are designed to provide reasonable protection against harmful interference when the equipment is operated in a commercial environment. This equipment generates, uses, and can radiate radio frequency energy and, if not installed and used in accordance with the instruction manual, may cause harmful interference to radio communications. Operation of this equipment in a residential area is likely to cause harmful interference in which case the user will be required to correct the interference at his own expense.

### **FCC Radiation Exposure Statement**

This device complies with FCC radiation exposure limits set forth for an uncontrolled environment and it also complies with Part 15 of the FCC RF Rules. This equipment must be installed and operated in accordance with provided instructions and the antenna(s) used for this transmitter must be installed to provide a separation distance of at least 20 cm from all persons and must not be co-located or operating in conjunction with any other antenna or transmitter. End-users and installers must be provided with antenna installation instructions and consider removing the no-collocation statement.

This device complies with Part 15 of the FCC Rules. Operation is subject to the following two conditions:

- (1) this device may not cause harmful interference, and
- (2) this device must accept any interference received, including interference that may cause undesired operation.

### **Caution!**

Any changes or modifications not expressly approved by the party responsible for compliance could void the user's authority to operate the equipment.

### **R&TTE Compliance Statement**

This equipment complies with all the requirements of DIRECTIVE 2014/30/EU OF THE EUROPEAN PARLIAMENT AND THE COUNCIL of March 9, 1999 on radio equipment and telecommunication terminal equipment and the mutual recognition of their conformity (R&TTE). The R&TTE Directive repeals and replaces in the directive 98/13/EEC (Telecommunications Terminal Equipment and Satellite Earth Station Equipment) As of April 8, 2000.

### **Safety**

This equipment is designed with the utmost care for the safety of those who install and use it. However, special attention must be paid to the dangers of electric shock and static electricity when working with electrical equipment. All guidelines of this and of the computer manufacture must therefore be allowed at all times to ensure the safe use of the equipment.

### **EU Countries Intended for Use**

The ETSI version of this device is intended for home and office use in Austria, Belgium, Bulgaria, Croatia, Cyprus, Czech, Denmark, Estonia, Finland, France, Germany, Greece, Hungary, Ireland, Italy, Latvia, Lithuania, Luxembourg, Malta, Netherlands, Poland, Portugal, Romania, Slovakia, Slovenia, Spain, Sweden, Turkey, and United Kingdom. The ETSI version of this device is also authorized for use in EFTA member states: Iceland, Liechtenstein, Norway, and Switzerland.

### **EU Countries Not Intended for Use**

None

## EU Declaration of Conformity

- English:** This equipment is in compliance with the essential requirements and other relevant provisions of Directive 2014/30/EU.
- Français:** Cet équipement est conforme aux exigences essentielles et autres dispositions de la directive 2014/30/EU.
- Čeština:** Toto zařízení je v souladu se základními požadavky a ostatními příslušnými ustanoveními směrnic 2014/30/EU.
- Polski:** Urządzenie jest zgodne z ogólnymi wymaganiami oraz szczególnymi warunkami określonymi Dyrektywą UE 2014/30/EU.
- Română:** Acest echipament este în conformitate cu cerințele esențiale și alte prevederi relevante ale Directivei 2014/30/EU.
- Русский:** Это оборудование соответствует основным требованиям и положениям Директивы 2014/30/EU.
- Magyar:** Ez a berendezés megfelel az alapvető követelményeknek és más vonatkozó irányelveknek (2014/30/EU).
- Türkçe:** Bu cihaz 2014/30/EU. direktifleri zorunlu istekler ve diğer hükümlerle ile uyumludur.
- Українська:** Обладнання відповідає вимогам і умовам директиви 2014/30/EU.
- Slovenčina:** Toto zariadenie spĺňa základné požiadavky a ďalšie príslušné ustanovenia smerníc 2014/30/EU.
- Deutsch:** Dieses Gerät erfüllt die Voraussetzungen gemäß den Richtlinien 2014/30/EU.
- Español:** El presente equipo cumple los requisitos esenciales de la Directiva 2014/30/EU.
- Italiano:** Questo apparecchio è conforme ai requisiti essenziali e alle altre disposizioni applicabili della Direttiva 2014/30/EU.
- Nederlands:** Dit apparaat voldoet aan de essentiële eisen en andere van toepassing zijnde bepalingen van richtlijn 2014/30/EU.
- Português:** Este equipamento cumpre os requisitos essenciais da Directiva 2014/30/EU.
- Norsk:** Dette utstyret er i samsvar med de viktigste kravene og andre relevante regler i Direktiv 2014/30/EU.
- Svenska:** Denna utrustning är i överensstämmelse med de väsentliga kraven och övriga relevanta bestämmelser i direktiv 2014/30/EU.
- Dansk:** Dette udstyr er i overensstemmelse med de væsentligste krav og andre relevante forordninger i direktiv 2014/30/EU.
- suomen kieli:** Tämä laite täyttää direktiivien 2014/30/EU. oleelliset vaatimukset ja muut asiaankuuluvat määräykset.

FOR USE IN 



## WEEE Directive & Product Disposal



At the end of its serviceable life, this product should not be treated as household or general waste. It should be handed over to the applicable collection point for the recycling of electrical and electronic equipment, or returned to the supplier for disposal.

## Declaration of Conformity

We, Edimax Technology Co., Ltd., declare under our sole responsibility, that the equipment described below complies with the requirements of the European R&TTE directives.

**Equipment: 54 Gigabit ports Web-Smart Switch with 6 SFP+ 10 Gigabit  
Model No.: GS-5654LX**

The following European standards for essential requirements have been followed:

### Directives 2014/30/EU

EMC : EN 55032:2015+AC:2016  
EN 61000-3-2:2014  
N 61000-3-3:2013  
EN 55035:2017

### Directives 2014/35/EU

Safety (LVD) : IEC 62368-1:2014 (2nd Edition) and/or EN 62368-1:2014+A11:2017

Edimax Technology Europe B.V.  
Fijenhof 2,  
5652 AE Eindhoven,  
The Netherlands

Date & Place of Issue: 30/Nov./2022, Eindhoven

Signature: 

Printed Name: David Huang

Title: Director

a company of:

Edimax Technology Co., Ltd.  
No. 278, Xinhua 1st Rd., Neihu Dist.,  
Taipei City, Taiwan

Date & Place of Issue: 30/Nov./2022, Taipei

Signature: 

Printed Name: Hunter Chen

Title: Director





# Declaration of Conformity

We, Edimax Technology Co., Ltd., declare under our sole responsibility, that the equipment described below complies with the requirements of the European R&TTE directives.

**Equipment: 54 Gigabit PoE ports Web-Smart Switch with 6 SFP+ 10 Gigabit  
Model No.: GS-5654PLX V2**

The following European standards for essential requirements have been followed:

## Directives 2014/30/EU

EMC : EN 55032:2015+A11:2020  
EN IEC 61000-3-2:2019  
EN 61000-3-3:2013+A1:2019  
EN 55035:2017+A11:2020

## Directives 2014/35/EU

Safety (LVD) : IEC 62368-1:2014 (2nd Edition) and/or EN 62368-1:2014+A11:2017

Edimax Technology Europe B.V.  
Fijenhof 2,  
5652 AE Eindhoven,  
The Netherlands

Date & Place of Issue: 30/Nov./2022, Eindhoven

Signature: 

Printed Name: David Huang

Title: Director

a company of:

Edimax Technology Co., Ltd.  
No. 278, Xinhua 1st Rd., Neihu Dist.,  
Taipei City, Taiwan

Date & Place of Issue: 30/Nov./2022, Taipei

Signature: 

Printed Name: Hunter Chen

Title: Director



## Declaration of Conformity

We, Edimax Technology Co., Ltd., declare under our sole responsibility, that the equipment described below complies with the requirements of the United Kingdom EMC and Safety directives.

**Equipment: 54 Gigabit ports Web-Smart Switch with 6 SFP+ 10 Gigabit  
Model No.: GS-5654LX**

The following European standards for essential requirements have been followed:

### **Electromagnetic Compatibility Regulations 2016 (S.I. 2016/1091)**

EMC : EN 55032:2015+AC:2016  
EN 61000-3-2:2014  
EN 61000-3-3:2013  
EN 55035:2017

### **Electrical Equipment (Safety) Regulations 2016 (S.I. 2016/1101)**

Safety (LVD) : IEC 62368-1:2014 (2nd Edition) and/or EN 62368-1:2014+A11:2017

Edimax Technology Europe B.V.  
Fijenhof 2,  
5652 AE Eindhoven,  
The Netherlands

Date & Place of Issue: 30/Nov./2022, Eindhoven

Signature:



Printed Name: David Huang

Title: Director

a company of:

Edimax Technology Co., Ltd.  
No. 278, Xinhua 1st Rd., Neihu Dist.,  
Taipei City, Taiwan

Date & Place of Issue: 30/Nov./2022, Taipei

Signature:



Printed Name: Hunter Chen

Title: Director



## Declaration of Conformity

We, Edimax Technology Co., Ltd., declare under our sole responsibility, that the equipment described below complies with the requirements of the United Kingdom EMC and Safety directives.

**Equipment: 54 Gigabit PoE ports Web-Smart Switch with 6 SFP+ 10 Gigabit  
Model No.: GS-5654PLX V2**

The following European standards for essential requirements have been followed:

### **Electromagnetic Compatibility Regulations 2016 (S.I. 2016/1091)**

EMC : EN 55032:2015+A11:2020  
EN IEC 61000-3-2:2019  
EN 61000-3-3:2013+A1:2019  
EN 55035:2017+A11:2020

### **Electrical Equipment (Safety) Regulations 2016 (S.I. 2016/1101)**

Safety (LVD) : IEC 62368-1:2014 (2nd Edition) and/or EN 62368-1:2014+A11:2017

Edimax Technology Europe B.V.  
Fijenhof 2,  
5652 AE Eindhoven,  
The Netherlands

Date & Place of Issue: 30/Nov./2022, Eindhoven

Signature:



Printed Name: David Huang

Title: Director

a company of:

Edimax Technology Co., Ltd.  
No. 278, Xinhua 1st Rd., Neihu Dist.,  
Taipei City, Taiwan

Date & Place of Issue: 30/Nov./2022, Taipei

Signature:



Printed Name: Hunter Chen

Title: Director

