

GS-5654LX, GS-5654PLX V2

User Manual

11-2022 / V1.0

Edimax Technology Co., Ltd.

No. 278, Xinhu 1st Rd., Neihu Dist., Taipei City, Taiwan

Email: support@edimax.com.tw

Edimax Technology Europe B.V.

Fijenhof 2, 5652 AE Eindhoven, The Netherlands

Email: support@edimax.nl

Edimax Computer Company

530 Technology Drive Suite 100, Irvine, CA 92618, USA

Email: support@edimax.us

Contents

I. Product Information.....	1
I-1. Package Content	1
I-2. Hardware Overview	2
I-3. LED Status.....	3
II. Installation	5
II-1. Physically Setup.....	5
II-2. Connection	6
III. Web-based Configuration Utility	8
IV. Web-based Switch Configuration.....	10
IV-1. Status	10
IV-1-1. System Information	10
IV-1-2. Logging Message	12
IV-1-3. Port.....	12
IV-1-3-1. Statistics.....	12
IV-1-3-2. Error Disabled	15
IV-1-3-3. Bandwidth Utilization.....	16
IV-1-4. Link Aggregation	16
IV-1-5. MAC Address Table.....	17
IV-2. Network	18
IV-2-1. IP Address.....	18
IV-2-2. System Time	20
IV-3. Port.....	22
IV-3-1. Port Setting.....	22
IV-3-2. Error Disable	24
IV-3-3. Link Aggregation	25
IV-3-3-1. Group.....	25
IV-3-3-2. Port Setting.....	28

IV-3-3-3.	LACP.....	30
IV-3-3-4.	EEE.....	31
IV-3-4.	Jumbo Frame.....	32
IV-4.	PoE	33
IV-4-1.	Global Setting.....	33
IV-4-2.	Priority Setting.....	36
IV-4-3.	Power Limit.....	36
IV-4-4.	PoE Status.....	37
IV-5.	VLAN.....	38
IV-5-1.	VLAN.....	38
IV-5-1-1.	Create VLAN.....	38
IV-5-1-2.	VLAN Configuration.....	40
IV-5-1-3.	Membership	41
IV-5-1-4.	Port Setting.....	42
IV-5-2.	Voice VLAN	44
IV-5-2-1.	Property.....	45
IV-5-2-2.	Voice OUI.....	46
IV-5-3.	Protocol VLAN.....	48
IV-5-3-1.	Protocol Group	48
IV-5-3-2.	Group Binding.....	49
IV-5-4.	MAC VLAN	50
IV-5-4-1.	MAC Group	50
IV-5-4-2.	Group Binding.....	52
IV-5-5.	Surveillance VLAN.....	53
IV-5-5-1.	Property.....	53
IV-5-5-2.	Surveillance OUI.....	55
IV-6.	MAC Address Table	56
IV-6-1.	Dynamic Address	56
IV-6-2.	Static Address.....	56
IV-6-3.	Filtering Address.....	57
IV-7.	Spanning Tree	57
IV-7-1.	Property.....	58
IV-7-2.	Port Setting.....	60
IV-7-3.	MST Instance	62
IV-7-4.	MST Port Setting.....	64
IV-7-5.	Statistics	66

IV-8.	Discovery	68
IV-8-1.	LLDP.....	68
IV-8-1-1.	Property	69
IV-8-1-2.	Port Setting	70
IV-8-1-3.	MED Network Policy	72
IV-8-1-4.	MED Port Setting	73
IV-8-1-5.	Packet View	75
IV-8-1-6.	Local Information.....	77
IV-8-1-7.	Neighbor	80
IV-8-1-8.	Statistics.....	83
IV-9.	Multicast	84
IV-9-1.	General.....	84
IV-9-1-1.	Property	85
IV-9-1-2.	Group Address	85
IV-9-1-3.	Router Port	87
IV-9-1-4.	Forward All.....	90
IV-9-1-5.	Throttling	92
IV-9-1-6.	Filtering Profile.....	93
IV-9-1-7.	Filtering Binding	95
IV-9-2.	IGMP Snooping	96
IV-9-2-1.	Property	96
IV-9-2-2.	Querier.....	99
IV-9-2-3.	Statistics.....	101
IV-9-3.	AV Over IP.....	102
IV-9-3-1.	General Property.....	102
IV-9-3-2.	IGMP Property	103
IV-9-3-3.	Querier.....	106
IV-9-3-4.	Statistics.....	107
IV-9-4.	MLD Snooping	107
IV-9-4-1.	Property	107
IV-9-4-2.	Statistics.....	111
IV-9-5.	MVR.....	111
IV-9-5-1.	Property	111
IV-9-5-2.	Port Setting	112
IV-9-5-3.	Group Address	114
IV-10.	Security	115
IV-10-1.	RADIUS	115
IV-10-2.	TACACS+	118

IV-10-3. Method List	120
IV-10-4. Login Authentication	121
IV-10-5. Management Access.....	121
IV-10-5-1. Management VLAN	121
IV-10-5-2. Management Service	121
IV-10-5-3. Management ACL.....	123
IV-10-5-4. Management ACE	124
IV-10-6. Authentication Manager.....	127
IV-10-6-1. Property.....	127
IV-10-6-2. Port Setting.....	132
IV-10-6-3. MAC-Base Local Account.....	135
IV-10-6-4. WEB-Base Local Account.....	137
IV-10-6-5. Sessions	138
IV-10-7. Port Security	139
IV-10-8. Traffic Segmentation	141
IV-10-9. Storm Control	142
IV-10-10. DoS	144
IV-10-10-1. Property	144
IV-10-10-2. Port Setting	146
IV-10-11. DHCP Snooping	147
IV-10-11-1. Property	147
IV-10-11-2. Statistics.....	148
IV-10-11-3. Option82 Property	149
IV-10-11-4. Option82 Circuit ID.....	151
IV-10-12. IP Source Guard	152
IV-10-12-1. Port Setting	152
IV-10-12-2. IMPV Binding.....	154
IV-10-12-3. Save Database	156
IV-11. ACL	157
IV-11-1. MAC ACL.....	157
IV-11-2. MAC ACE.....	158
IV-11-3. IPv4 ACL.....	160
IV-11-4. IPv4 ACE.....	161
IV-11-5. ACL Binding.....	164
IV-12. QoS.....	166
IV-12-1. General.....	166
IV-12-1-1. Property.....	166
IV-12-1-2. Queue Scheduling	168
IV-12-1-3. CoS Mapping.....	169

IV-12-1-4. DSCP Mapping.....	170
IV-12-1-5. IP Precedence Mapping	170
IV-12-2. Rate Limit	171
III-12-2-1. Ingress/Egress Port	172
IV-13. Diagnostics	173
IV-13-1. Logging	173
IV-13-1-1. Property	173
IV-13-1-2. Remote Server	175
IV-13-2. Mirroring	175
IV-13-3. Ping.....	178
IV-13-4. Traceroute	179
IV-13-5. Copper Test	180
IV-13-6. Fiber Module	181
IV-13-7. UDLD	182
IV-13-7-1. Property	182
IV-13-7-2. Neighbor	184
IV-14. Management.....	185
IV-14-1. User Account	185
IV-14-2. Fireware	187
IV-14-2-1. Upgrade / Backup	187
IV-14-2-2. Active Image	190
IV-14-3. Configuration.....	192
IV-14-3-1. Upgrade / Backup	192
IV-14-3-2. Save Configuration.....	196
IV-14-4. SNMP.....	196
IV-14-4-1. View	196
IV-14-4-2. Group.....	197
IV-14-4-3. Community	200
IV-14-4-4. User	202
IV-14-4-5. Engine ID.....	204
IV-14-4-6. Trap Event.....	207
IV-14-4-7. Notification	207
IV-14-5. Time Range	212

V. More Information213

VI. Safety Instructions.....213

I. Product Information

- **GS-5654LX:** 54-Port Gigabit Web Smart Switch with 6 SFP+ 10G Ports
- **GS-5654PLX V2:** 54-Port Gigabit PoE+ Long Range Web Smart Switch with 6 SFP+ 10G Ports

I-1. Package Content

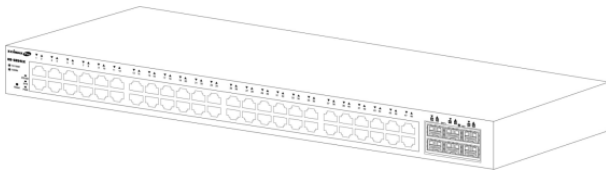

GS-5654LX

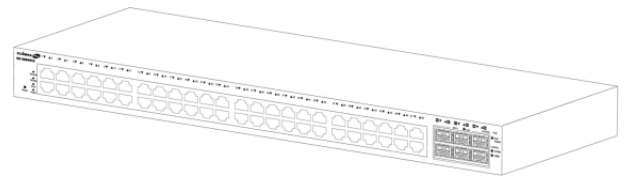

GS-5654PLX V2

or



**Quick Installation
Guide**



Power Cord

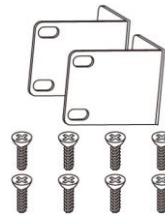

Rack-Mount Kit



Console Cable

I-2. Hardware Overview

GS-5654LX:

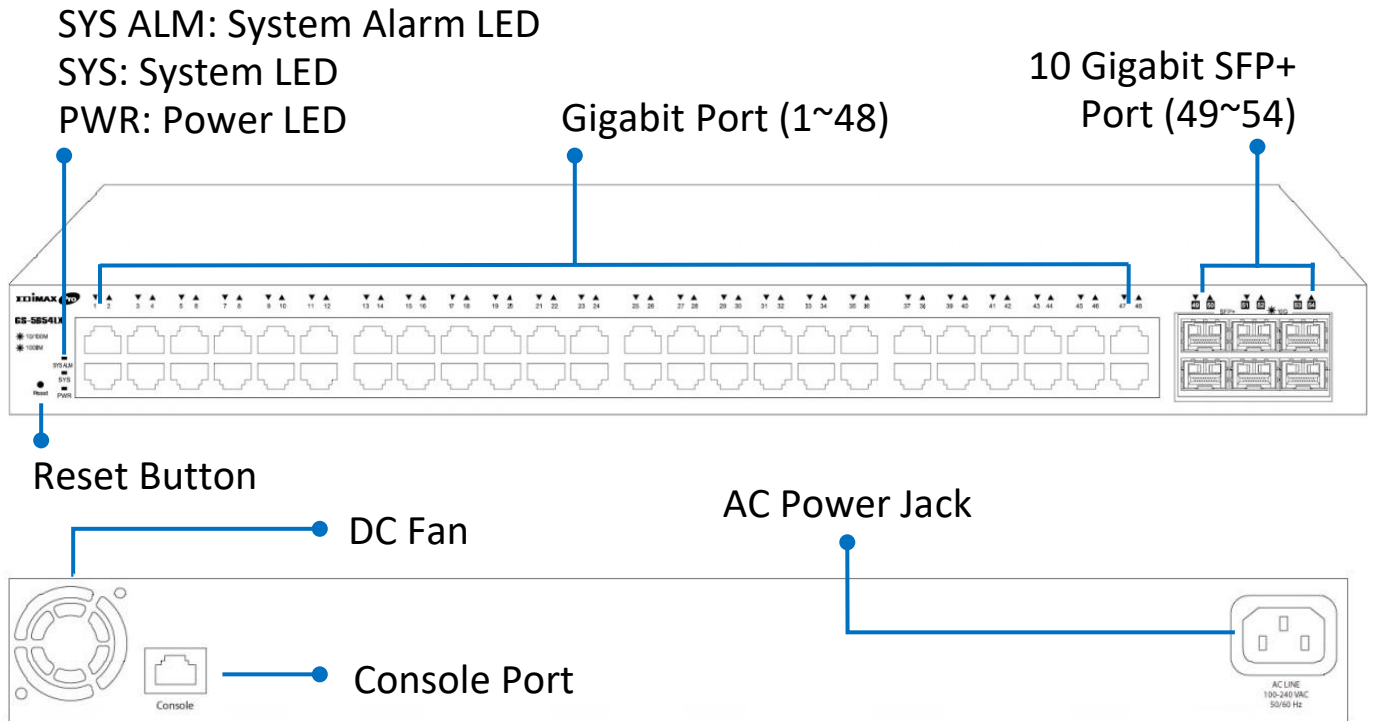

GS-5654PLX V2:

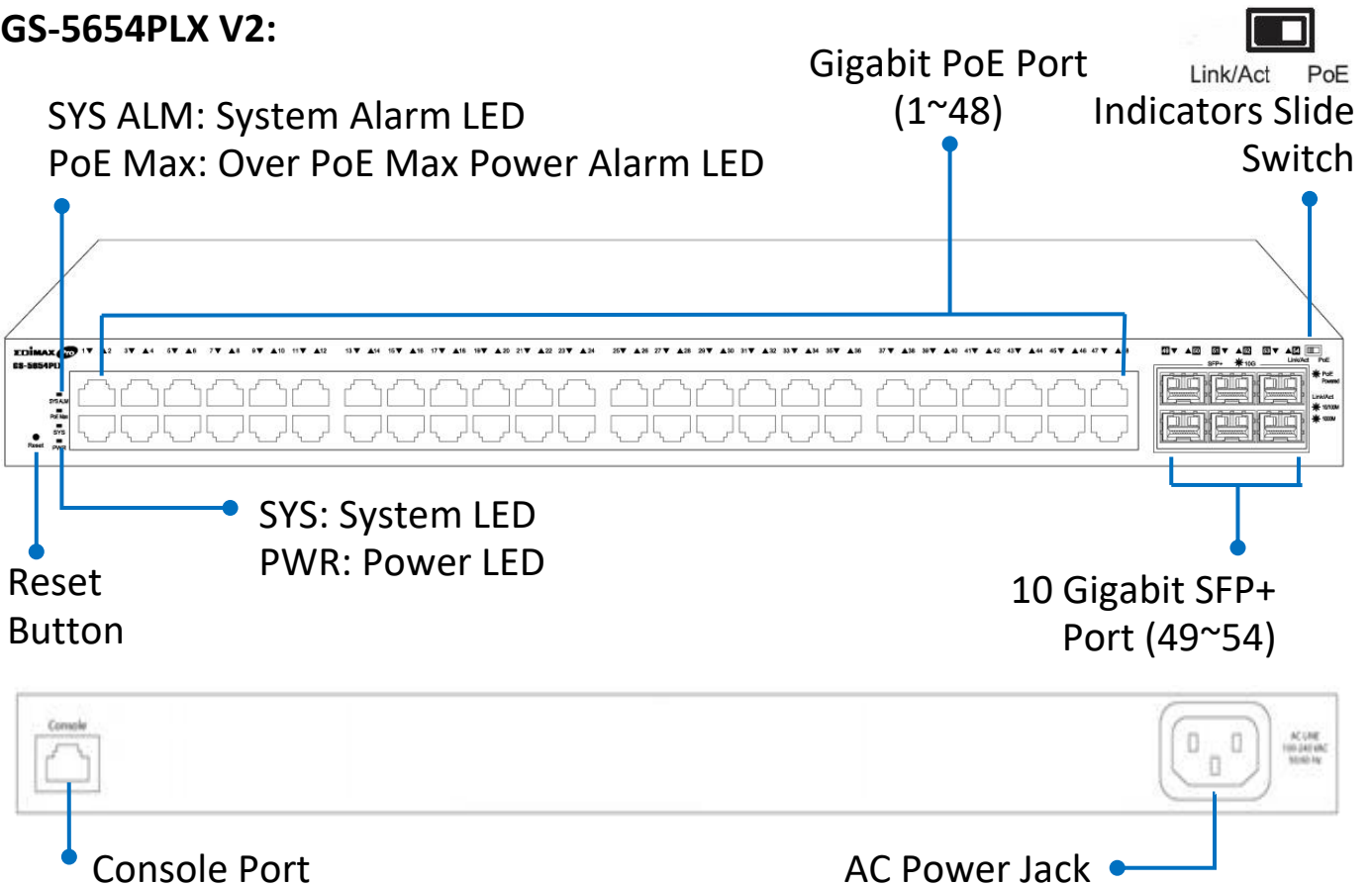



I-3. LED Status

GS-5654LX

Function	Color	Status	Description
PWR	Green	On	Power on
		Off	Power off
SYS	Green	On	Power on
		Blinking	System is booting up
		Off	Power off
SYS ALM	Red	On	System failure
		Off	Device in good condition
Link/Act (1~48 Port)	Green	On	Link at 1000Mbps
		Blinking	Sending or receiving data
		Off	Port disconnected or link fail
	Amber	On	Link at 10/100Mbps
		Blinking	Sending or receiving data
		Off	Port disconnected or link fail
10G SFP+ Port (49-54 Port)	Blue	On	Link at 10Gbps
		Blinking	Sending or receiving data
		Off	Port disconnected or link fail
	Green	On	Link at 1Gbps
		Blinking	Sending or receiving data
		Off	Port disconnected or link fail

GS-5654PLX V2

Function	Color	Status	Description
PWR	Green	On	Power on
		Off	Power off
SYS	Green	On	Power on
		Blinking	System is booting up
		Off	Power off
SYS ALM	Red	On	System failure (Overheat, wrong voltage)
		Off	Device in good condition
PoE Max	Green	On	Over PoE max. power
		Off	Not over PoE max power
10 G SFP+ Port (Port 49~54)	Blue	On	Link at 10Gbps
		Blinking	Sending or receiving data
		Off	Port disconnected or link fail
	Green	On	Link at 1000Mbps
		Blinking	Sending or receiving data
		Off	Port disconnected or link fail
Link/Act or PoE Indicators Slide Switch  Link/Act PoE	Link/Act (Left) 		Show Link/Act network connection status (Port 1 ~48)
	PoE (Right) 		Show PoE connection status (Port 1~48)
Link/Act (Left)	Green	On	Link at 1000Mbps
		Blinking	Sending or receiving data
		Off	Port disconnected or link fail
	Amber	On	Link at 10/100Mbps
		Blinking	Sending or receiving data
		off	Port disconnected or link fail
PoE (Right)	Green	On	Feeding power to PoE devices
		Off	PoE function is not active

II. Installation

Read the following topics and perform the procedures in the correct order. Incorrect installation may cause damage to the product.

II-1. Physically Setup

There are two ways to physically set up the switch. No matter how you installed the switch, please keep it with good ventilation.

1. **Desktop Placement:** Attach the supplied rubber feet to the recessed areas on the bottom of the switch. Place the switch on a flat surface and keep it with good ventilation.

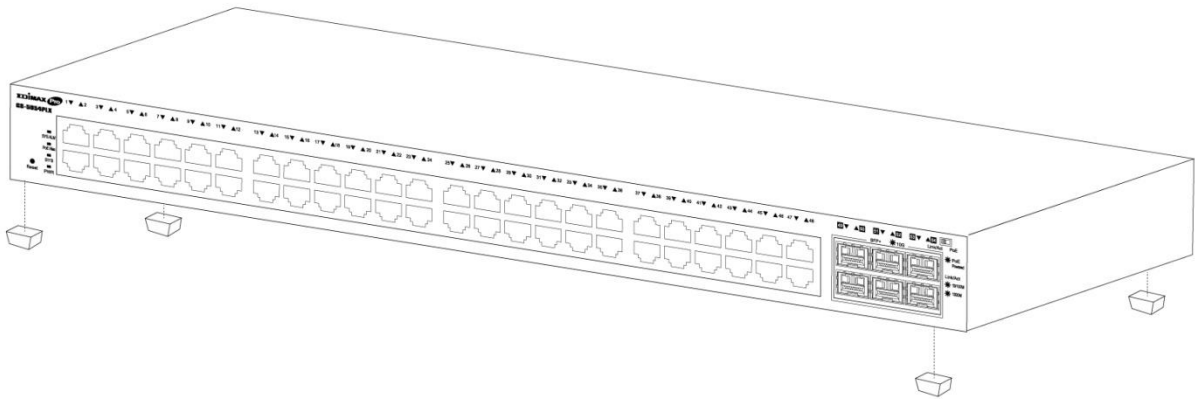

2. **Rack-Mount Installation:** You can mount the switch in any standard size, 19-inch (about 48 cm) wide rack with 1 Rack Unit (1U) of space, which is 1.75 inches (4.45 cm) high.

First, align the mounting brackets with the mounting holes on the switch's side panels and secure the brackets with the screws.

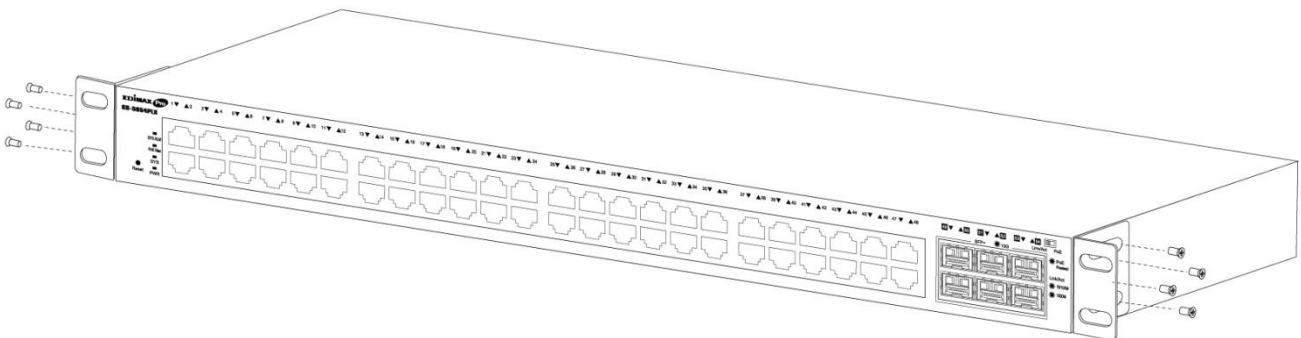

Then secure the switch on the equipment rack and keep it with good ventilation.

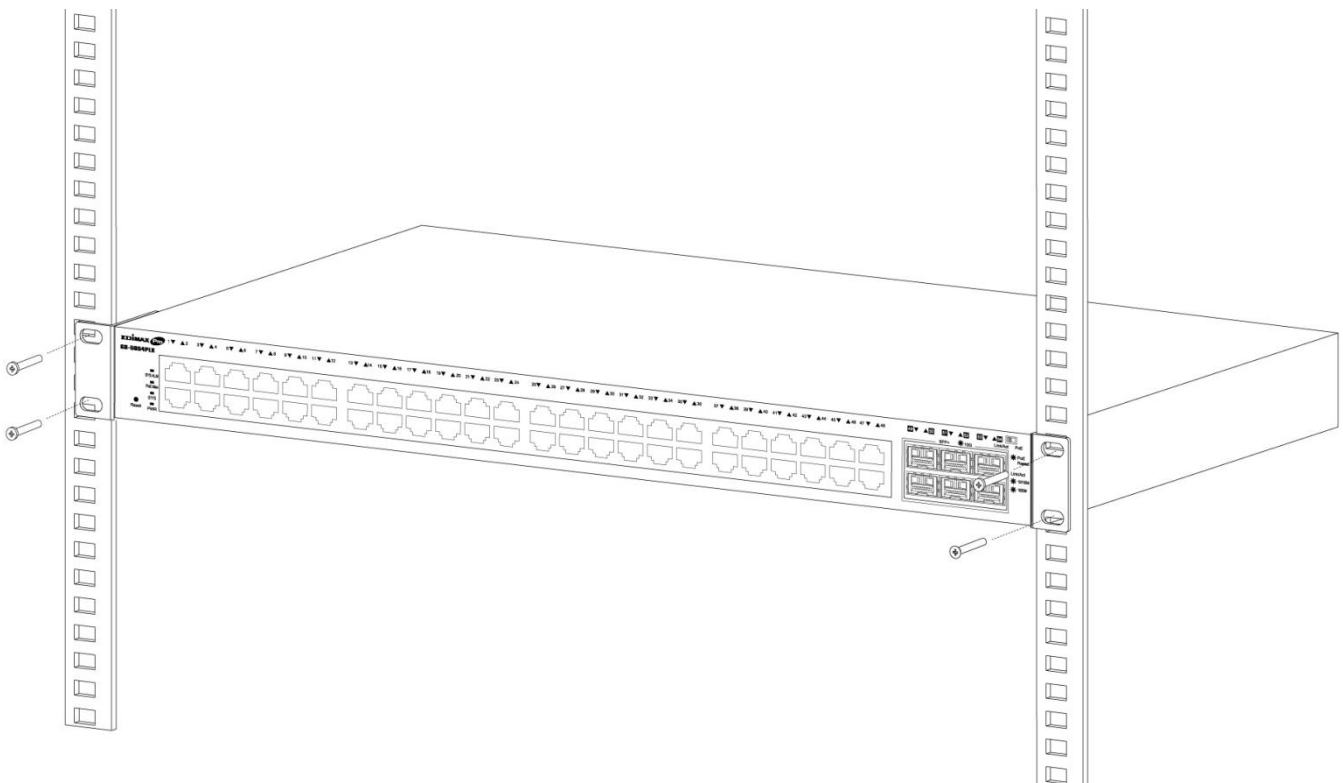

II-2. Connection

- 1. Power on:** Connect the power cord to the switch and the power outlet. The switch is powered by the 100-240VAC 50/60Hz external high-performance power supply. (Note: Make sure the PWR LED is green.)
- 2. Uplink:** Plug the SFP/SFP+ cable into the SFP/SFP+ slot (Note: Make sure that the LED is blue (SFP+), green or amber (SFP)) or plug the standard Cat5e or above Ethernet cable into the LAN port (Note: Make sure that the LED is green or amber) and connect it to another switch.
- 3. Connect devices:** Plug the standard Cat5e or above Ethernet cable into the LAN port and connect to any networking device with an Ethernet port. (Note: Make sure that the "LAN" Link/Act LED is green or amber.) The hardware installation is complete!

- 4. Connect a computer:** Connect your computer with the switch and get ready for web-based configuration with following “Section III Web-based Configuration Utility”.

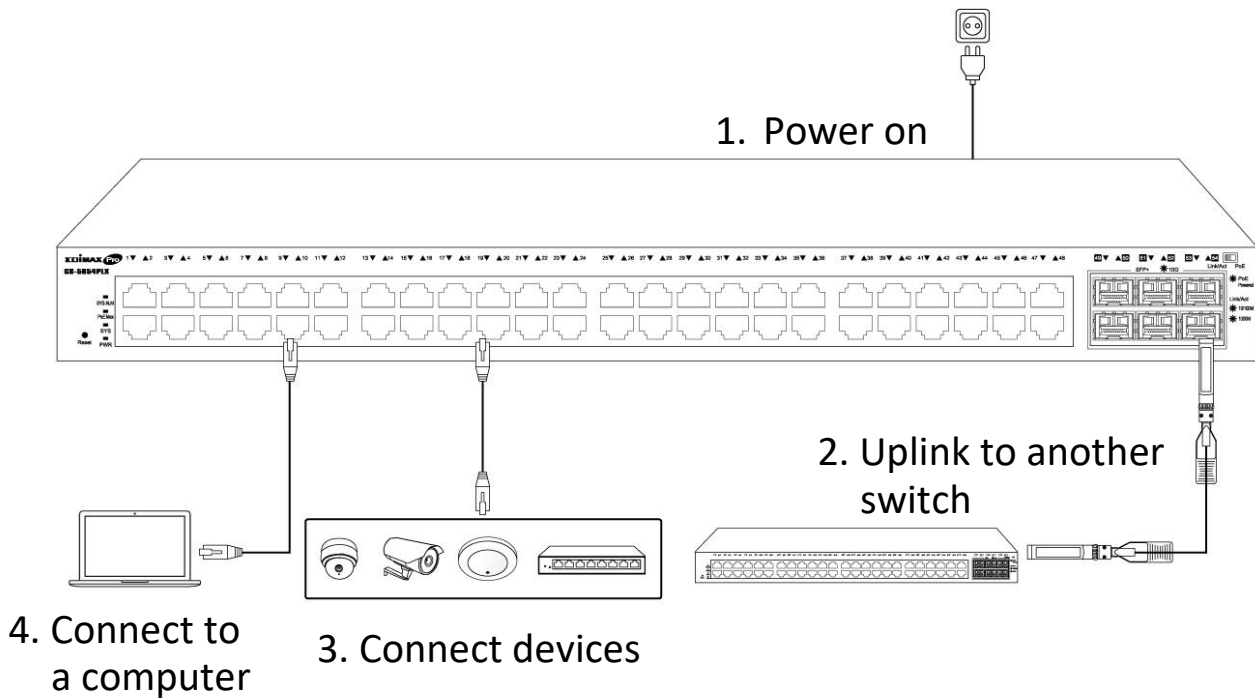

III. Web-based Configuration Utility

This section describes how to navigate the web-based switch configuration utility through web browser. **Be sure to disable any browser pop-up blocker.**

Browser Restrictions

- If you are using older versions of Internet Explorer, you cannot directly use an IPv6 address to access the device. You can, however, use the DNS (Domain Name System) server to create a domain name that contains the IPv6 address, and then use that domain name in the address bar in place of the IPv6 address.
- If you have multiple IPv6 interfaces on your management station, use the IPv6 global address instead of the IPv6 link local address to access the device from your browser.

Launching the Configuration Utility

1. Connect your computer with the switch then open a web browser.
2. Enter the IP address of the switch you are configuring in the address bar on the browser (factory default IP address is 192.168.2.1) and then press Enter. Please make sure that your computer's IP address is in the same subnet as this switch. The default IP address is an IP address in the range of 192.168.2.X (X=2-254). You can modify the IP address of your computer if you need.

Default IP	192.168.2.1
Default User Name	admin
Default Password	1234

3. The default username is “admin” and the default password is “1234”.

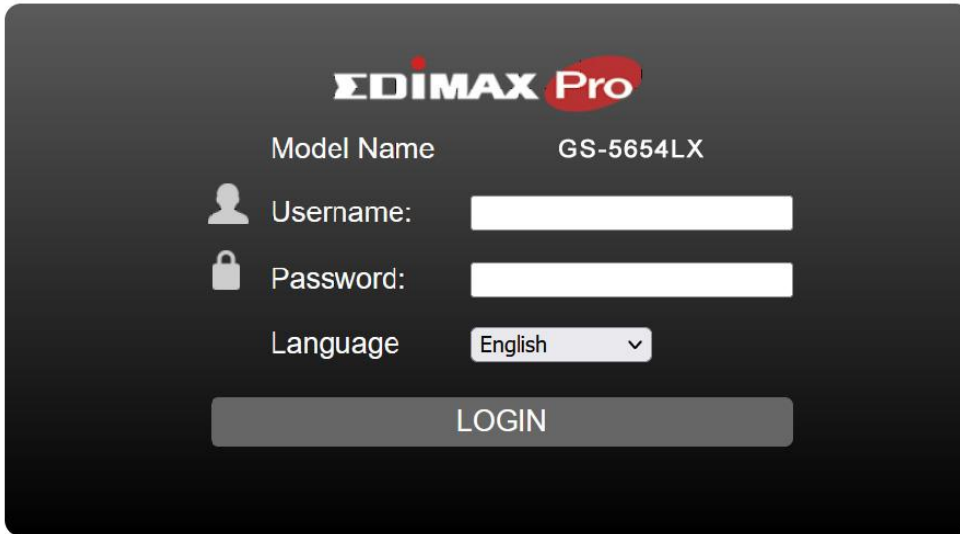

The image shows a login interface for EDIMAX Pro. At the top, the logo "EDIMAX Pro" is displayed. Below it, the "Model Name" is listed as "GS-5654LX". The login form includes a "Username:" field with a person icon, a "Password:" field with a lock icon, and a "Language" dropdown menu currently set to "English". A "LOGIN" button is positioned at the bottom of the form.

4. The first time that you log in with the default username and password, you are required to set a new password.

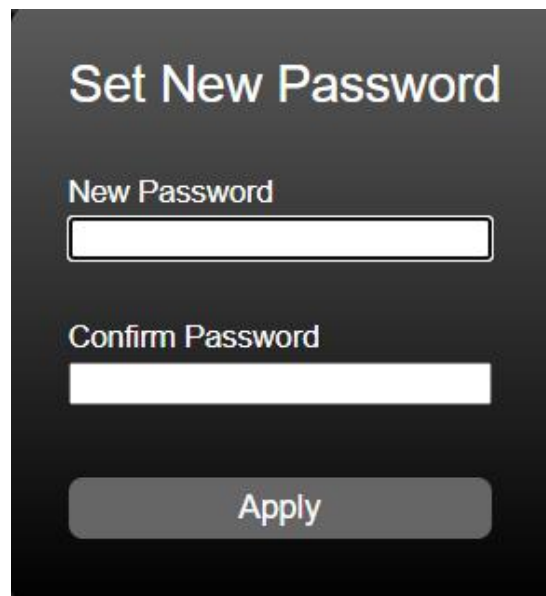

The image shows a "Set New Password" screen. It features two input fields: "New Password" and "Confirm Password". Below the input fields is an "Apply" button.

5. Following the next section for details of Web-based Configuration Utility.

IV. Web-based Switch Configuration

This chapter describes how to use the web-based management interface (Web UI) to configure the switch's features.

IV-1. Status

Use the Status pages to view system information and status.

IV-1-1. System Information

This page shows switch panel, CPU utilization, Memory utilization and other system current information. It also allows user to edit some system information.

To display the Device Information web page, click **Status > System Information**.

Status >> System Information

- Status
 - System Information**
 - Logging Message
- Port
 - Link Aggregation
 - MAC Address Table
- Network
 - Port
 - PoE
 - VLAN
 - MAC Address Table
 - Spanning Tree
 - Discovery
 - Multicast
 - Security
 - ACL
 - QoS
 - Diagnostics
 - Management

System Information		Edit
Model	GS-5654PLX	
System Name	Switch	
System Location	Default	
System Contact	Default	
MAC Address	FC:8F:C4:0D:1E:F7	
IPv4 Address	192.168.2.1	
IPv6 Address	fe80::fe8f:c4ff:fe0d:1ef7:64	
System Uptime	0 day, 1 hr, 27 min and 23 sec	
Current Time	1970-01-01 01:27:23 UTC+8	
Loader Version	3.6.1.1	
Loader Date	Mar 17 2021 - 16:13:47	
Firmware Version	1.0.3	
Firmware Date	Jul 21 2021 - 17:08:49	
Telnet	Disabled	
SSH	Disabled	
HTTP	Enabled	
HTTPS	Disabled	
SNMP	Enabled	

Item	Description
Model	Model name of the switch.
System Name	System name of the switch. This name will also use as CLI prefix of each line. ("Switch>" or "Switch#").
System Location	Location information of the switch.
System Contact	Contact information of the switch.
MAC Address	Base MAC address of the switch.
IPv4 Address	Current system IPv4 address.
IPv6 Address	Current system IPv6 address.
System Uptime	Total elapsed time from booting.
Current Time	Current system time.
Loader Version	Boot loader image version.
Loader Date	Boot loader image build date.
Firmware Version	Current running firmware image version.
Firmware Date	Current running firmware image build date.
Telnet	Current Telnet service enable/disable state.
SSH	Current SSH service enable/disable state.
HTTP	Current HTTP service enable/disable state.
HTTPS	Current HTTPS service enable/disable state.
SNMP	Current SNMP service enable/disable state.

Click "Edit" button on the table title to edit following system information.

Edit System Information

System Name	<input type="text" value="Switch"/>
System Location	<input type="text" value="Default"/>
System Contact	<input type="text" value="Default"/>

Status > System Information > Edit System Information

Item	Description
System Name	System name of the switch. This name will also use as CLI prefix of each line. ("Switch>" or "Switch#").
System Location	Location information of the switch.
System Contact	Contact information of the switch.

IV-1-2. Logging Message

To view the logging messages stored on the RAM and Flash, click **Status > Logging Message**.

Logging Message Table

Viewing **RAM** ▾

Showing **All** ▾ entries

Showing 1 to 4 of 4 entries

Log ID	Time	Severity	Description
1	Jan 01 2000 00:01:19	notice	New http connection for user admin, source 192.168.2.22 ACCEPTED
2	Jan 01 2000 00:01:01	notice	GigabitEthernet28 link up
3	Jan 01 2000 00:00:58	notice	RESTART: System restarted - Cold Start
4	Jan 01 2000 00:00:58	notice	Logging is enabled

First Previous **1** Next Last

Clear Refresh

Item	Description
Log ID	The log identifier.
Time	The time stamp for the logging message.
Severity	The severity for the logging message.
Description	The description of logging message.
Viewing	The logging view including: <ul style="list-style-type: none">● RAM: Show the logging messages stored on the RAM.● Flash: Show the logging messages stored on the Flash.
Clear	Clear the logging messages.
Refresh	Refresh the logging messages.

IV-1-3. Port

IV-1-3-1. Statistics

This page displays standard counters on network traffic from the Interfaces, Ethernet-like and RMONMIB. Interfaces and Ethernet-like counters display errors on the traffic passing through each port. RMON counters provide a total count of different frame types and sizes passing through each port. The “Clear” button will clear MIB counter of current selected port.

To display the Port Flow Chart web page, click **Status > Port > Statistics**.

Port	GE1 ▼
MIB Counter	<input checked="" type="radio"/> All <input type="radio"/> Interface <input type="radio"/> Etherlike <input type="radio"/> RMON
Refresh Rate	<input type="radio"/> None <input type="radio"/> 5 sec <input checked="" type="radio"/> 10 sec <input type="radio"/> 30 sec

Clear

Interface	
ifInOctets	0
ifInUcastPkts	0
ifInNUcastPkts	0
ifInDiscards	0
ifOutOctets	0
ifOutUcastPkts	0
ifOutNUcastPkts	0
ifOutDiscards	0
ifInMulticastPkts	0
ifInBroadcastPkts	0
ifOutMulticastPkts	0
ifOutBroadcastPkts	0
Etherlike	
dot3StatsAlignmentErrors	0
dot3StatsFCSErrors	0
dot3StatsSingleCollisionFrames	0
dot3StatsMultipleCollisionFrames	0
dot3StatsDeferredTransmissions	0
dot3StatsLateCollisions	0
dot3StatsExcessiveCollisions	0

dot3StatsSymbolErrors	0
dot3ControlInUnknownOpcodes	0
dot3InPauseFrames	0
dot3OutPauseFrames	0
RMON	
etherStatsDropEvents	0
etherStatsOctets	0
etherStatsPkts	0
etherStatsBroadcastPkts	0
etherStatsMulticastPkts	0
etherStatsCRCAlignErrors	0
etherStatsUnderSizePkts	0
etherStatsOverSizePkts	0
etherStatsFragments	0
etherStatsJabbers	0
etherStatsCollisions	0
etherStatsPkts64Octets	0
etherStatsPkts65to127Octets	0
etherStatsPkts128to255Octets	0
etherStatsPkts256to511Octets	0
etherStatsPkts512to1023Octets	0
etherStatsPkts1024to1518Octets	0

Item	Description
Port	Select one port to show counter statistics.
MIB Counter	Select the MIB counter to show different counter type <ul style="list-style-type: none"> ● All: All counters. ● Interface: Interface related MIB counters. ● Etherlike: Ethernet-like related MIB counters. ● RMON: RMON related MIB counters.
Refresh Rate	Refresh the web page every period of seconds to get new counter of specified port.

IV-1-3-2. Error Disabled

To display the Error Disabled web page, click **Status > Port > Error Disabled**.

Error Disabled Table

<input type="checkbox"/>	Port	Reason	Time Left (sec)
<input type="checkbox"/>	GE1	--	--
<input type="checkbox"/>	GE2	--	--
<input type="checkbox"/>	GE3	--	--
<input type="checkbox"/>	GE4	--	--
<input type="checkbox"/>	GE5	--	--
<input type="checkbox"/>	GE6	--	--
<input type="checkbox"/>	GE7	--	--
<input type="checkbox"/>	GE8	--	--
<input type="checkbox"/>	GE9	--	--
<input type="checkbox"/>	GE10	--	--
<input type="checkbox"/>	GE11	--	--
<input type="checkbox"/>	GE12	--	--
<input type="checkbox"/>	GE13	--	--
<input type="checkbox"/>	GE14	--	--
<input type="checkbox"/>	GE15	--	--
<input type="checkbox"/>	GE16	--	--
<input type="checkbox"/>	GE17	--	--
<input type="checkbox"/>	GE18	--	--
<input type="checkbox"/>	GE19	--	--
<input type="checkbox"/>	GE20	--	--
<input type="checkbox"/>	GE21	--	--
<input type="checkbox"/>	GE22	--	--
<input type="checkbox"/>	GE23	--	--
<input type="checkbox"/>	GE24	--	--
<input type="checkbox"/>	XGE1	--	--
<input type="checkbox"/>	XGE2	--	--
<input type="checkbox"/>	XGE3	--	--
<input type="checkbox"/>	XGE4	--	--
<input type="checkbox"/>	LAG1	--	--
<input type="checkbox"/>	LAG2	--	--
<input type="checkbox"/>	LAG3	--	--
<input type="checkbox"/>	LAG4	--	--
<input type="checkbox"/>	LAG5	--	--
<input type="checkbox"/>	LAG6	--	--
<input type="checkbox"/>	LAG7	--	--
<input type="checkbox"/>	LAG8	--	--

Refresh Recover

Item	Description
<input type="checkbox"/>	Select one or more port to operate.
Port	Interface or port number.
Reason	Port will be disabled by one of the following error reason: <ul style="list-style-type: none"> ● BPDU Guard ● UDLD ● Self Loop ● Broadcast Flood ● Unknown Multicast Flood ● Unicast Flood ● ACL ● Port Security Violation ● DHCP rate limit ● ARP rate limit
Time Left (sec)	The time left in second for the error recovery.
Refresh	Refresh the current page.
Recover	Recover the selected port status.

IV-1-3-3. Bandwidth Utilization

This page allow user to browse ports' bandwidth utilization in real time. This page will refresh automatically in every refresh period.

To display Bandwidth Utilization web page, click **Status > Port > Bandwidth Utilization**.

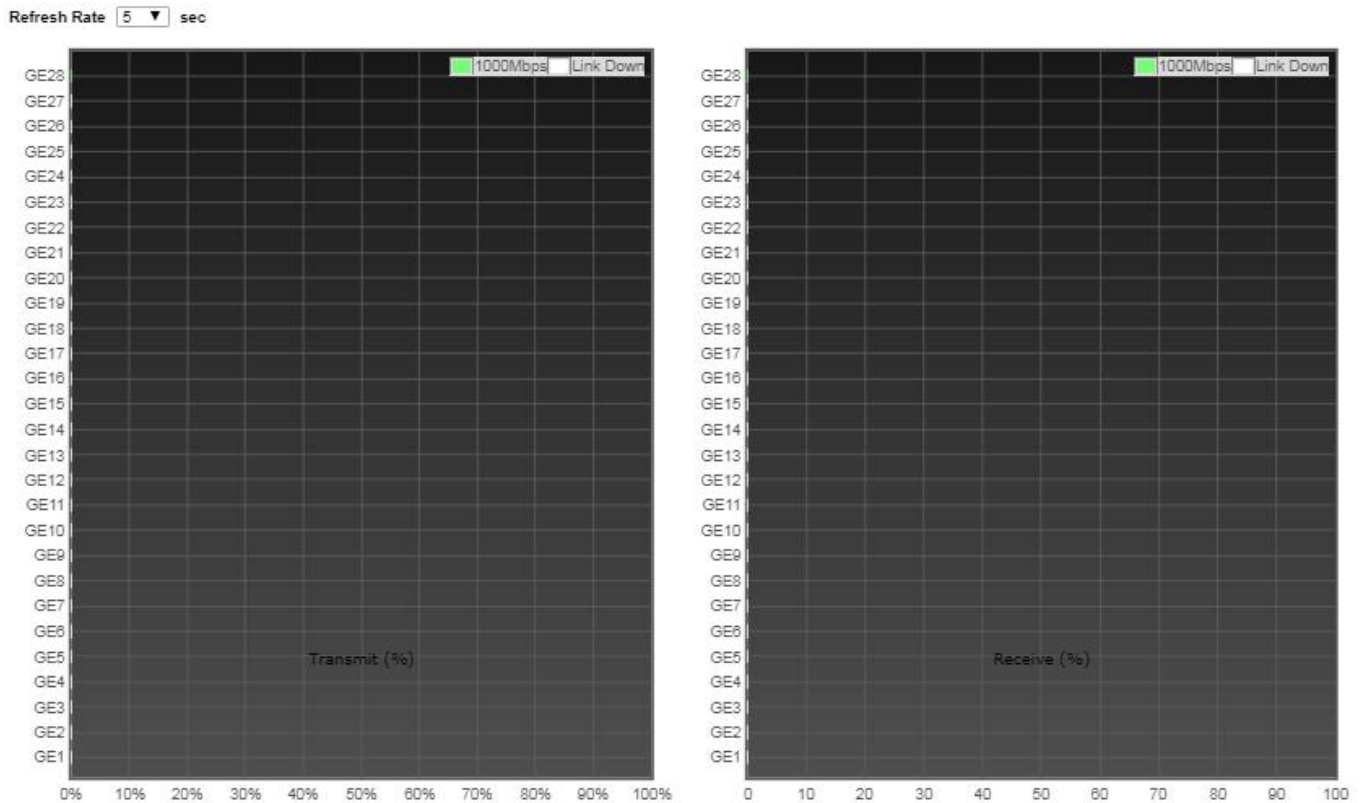

Item	Description
Refresh Rate	Refresh the web page every period of seconds to get new bandwidth utilization data.

IV-1-4. Link Aggregation

To display the Link Aggregation web page, click **Status > Link Aggregation**.

Link Aggregation Table

LAG	Name	Type	Link Status	Active Member	Inactive Member
LAG 1		---	---		
LAG 2		---	---		
LAG 3		---	---		
LAG 4		---	---		
LAG 5		---	---		
LAG 6		---	---		
LAG 7		---	---		
LAG 8		---	---		

Item	Description
LAG	LAG Name.
Name	LAG port description.
Type	<p>The type of the LAG.</p> <ul style="list-style-type: none"> ● Static: The group of ports assigned to a static LAG are always active members. ● LACP: The group of ports assigned to dynamic LAG are candidate ports. LACP determines which candidate ports are active member ports.
Link Status	LAG port link status.
Active Member	Active member ports of the LAG.
Inactive Member	Inactive member ports of the LAG.

IV-1-5. MAC Address Table

The MAC address table page displays all MAC address entries on the switch including static MAC address created by administrator or auto learned from hardware. The “Clear” button will clear all dynamic entries and “Refresh” button will retrieve latest MAC address entries and show them on page.

To display the MAC Address Table web page, click **Status > MAC Address Table**.

MAC Address Table

Showing entries Showing 1 to 2 of 2 entries

VLAN	MAC Address	Type	Port
1	FC:8F:C4:0D:1E:F7	Management	CPU
1	A4:1F:72:57:57:9E	Dynamic	GE48

Item	Description
VLAN	VLAN ID of the mac address.
MAC Address	MAC address.
Type	The type of MAC address <ul style="list-style-type: none"> ● Management: DUT's base mac address for management Purpose. ● Static: Manually configured by administrator ● Dynamic: Auto learned by hardware.
Port	The type of Port <ul style="list-style-type: none"> ● CPU: DUT's CPU port for management purpose. ● Other: Normal switch port.

IV-2. Network

Use the Network pages to configure settings for the switch network interface and how the switch connects to a remote server to get services.

IV-2-1. IP Address

This section allows you to edit the IP address, Netmask, Gateway and DNS server of the switch.

To view the IP Address menu, navigate to **Network > IP Address**.

The screenshot shows the 'IPv4 Address' configuration page. It features a sidebar on the left with labels for 'Address Type', 'IP Address', 'Subnet Mask', 'Default Gateway', 'DNS Server 1', and 'DNS Server 2'. The main area contains the following settings:

- Address Type:** Radio buttons for 'Static' (selected) and 'Dynamic'.
- IP Address:** Text input field containing '192.168.2.1'.
- Subnet Mask:** Text input field containing '255.255.255.0'.
- Default Gateway:** Text input field containing '192.168.2.254'.
- DNS Server 1:** Text input field containing '168.95.1.1'.
- DNS Server 2:** Text input field containing '168.95.192.1'.

IPv6 Address

Auto Configuration	<input checked="" type="checkbox"/> Enable
DHCPv6 Client	<input type="checkbox"/> Enable
IPv6 Address	<input style="width: 100%;" type="text"/>
Prefix Length	<input style="width: 80%;" type="text" value="0"/> (0 - 128)
IPv6 Gateway	<input style="width: 100%;" type="text"/>
DNS Server 1	<input style="width: 100%;" type="text"/>
DNS Server 2	<input style="width: 100%;" type="text"/>

Operational Status

IPv4 Address	192.168.2.1
IPv4 Default Gateway	192.168.2.254
IPv6 Address	fe80::76da:38ff:fe17:6e7a/64
IPv6 Gateway	::
Link Local Address	fe80::76da:38ff:fe17:6e7a/64

Item	Description
Address Type	The address type of switch IP configuration including <ul style="list-style-type: none"> ● Static: Static IP configured by users will be used. ● Dynamic: Enable the DHCP to obtain the IP address from a DHCP server.
IP Address	Specify the switch static IP address on the static configuration.
Subnet Mask	Specify the switch subnet mask on the static configuration.
Default Gateway	Specify the default gateway on the static configuration. The default gateway must be in the same subnet with switch IP address configuration.
DNS Server 1	Specify the primary user-defined IPv4 DNS server configuration.
DNS Server 2	Specify the secondary user-defined IPv4 DNS server configuration.
Table 3-2: IPv6 Address fields	
IPv4 Address	The operational IPv4 address of the switch.
IPv4 Gateway	The operational IPv4 gateway of the switch.
IPv6 Address v6	The operational IPv6 address of the switch.
IPv6 Gateway	The operational IPv6 gateway of the switch.
Link Local Address	The IPv6 link local address for the switch.

IV-2-2. System Time

This page allow user to set time source, static time, time zone and daylight saving settings. Time zone and daylight saving takes effect both static time or time from SNTP server.

To display System Time page, click **Network > System Time**.

Source	<input type="radio"/> SNTP <input type="radio"/> From Computer <input checked="" type="radio"/> Manual Time
Time Zone	UTC +8:00 ▾
SNTP	
Address Type	<input type="radio"/> Hostname <input type="radio"/> IPv4
Server Address	<input type="text"/>
Server Port	<input type="text" value="123"/> (1 - 65535, default 123)
Manual Time	
Date	<input type="text" value="2021-08-30"/> YYYY-MM-DD
Time	<input type="text" value="14:57:44"/> HH:MM:SS
Daylight Saving Time	
Type	<input checked="" type="radio"/> None <input type="radio"/> Recurring <input type="radio"/> Non-recurring <input type="radio"/> USA <input type="radio"/> European
Offset	<input type="text" value="60"/> Min (1 - 1440, default 60)
Recurring	From: Day <input type="text" value="Sun"/> ▾ Week <input type="text" value="First"/> ▾ Month <input type="text" value="Jan"/> ▾ Time <input type="text"/>
	To: Day <input type="text" value="Sun"/> ▾ Week <input type="text" value="First"/> ▾ Month <input type="text" value="Jan"/> ▾ Time <input type="text"/>
Non-recurring	From: <input type="text"/> YYYY-MM-DD <input type="text"/> HH:MM
	To: <input type="text"/> YYYY-MM-DD <input type="text"/> HH:MM
Operational Status	
Current Time	2021-08-30 14:57:44 UTC+8

Item	Description
Source	Select the time source. <ul style="list-style-type: none"> ● SNTP: Time sync from NTP server. ● From Computer: Time set from browser host. ● Manual Time: Time set by manually configure.
Time Zone	Select a time zone difference from listing district.
SNTP	
Address Type	Select the address type of NTP server. This is enabled when time source is SNTP.
Server Address	Input IPv4 address or hostname for NTP server. This is enabled when time source is SNTP.
Server Port	Input NTP port for NTP server. Default is 123. This is enabled when time source is SNTP.
Manual Time	
Date	Input manual date. This is enabled when time source is manual.
Time	Input manual time. This is enabled when time source is manual.
Daylight Saving Time	
Type	Select the mode of daylight saving time. <ul style="list-style-type: none"> ● Disable: Disable daylight saving time. ● Recurring: Using recurring mode of daylight saving time. ● Non-Recurring: Using non-recurring mode of daylight saving time. ● USA: Using daylight saving time in the United States that starts on the second Sunday of March and ends on the first Sunday of November. ● European: Using daylight saving time in the Europe that starts on the last Sunday in March and ending on the last Sunday in October.
Offset	Specify the adjust offset of daylight saving time.
Recurring From	Specify the starting time of recurring daylight saving time. This field available when selecting "Recurring" mode.
Recurring To	Specify the ending time of recurring daylight saving time. This field available when selecting "Recurring" mode.
Non-recurring From	Specify the starting time of non-recurring daylight saving time. This field available when selecting "Non-Recurring" mode.
Non-recurring To	Specify the ending time of recurring daylight saving time. This field available when selecting "Non-Recurring" mode.
Non-recurring From	Specify the starting time of non-recurring daylight saving time. This field available when selecting "Non-Recurring"

	mode.
Non recurring To	Specify the ending time of recurring daylight saving time. This field available when selecting “Non-Recurring” mode.

IV-3. Port

Use the Port pages to configure settings for switch port related features.

IV-3-1. Port Setting

This page shows port current status and allow user to edit port configurations. Select port entry and click “Edit” button to edit port configurations.

To display Port Setting web page, click **Port > Port Setting**.

Entry	Port	Type	Description	State	Link Status	Speed	Duplex	Flow Control
<input type="checkbox"/>	1	GE1	1000M Copper	Enabled	Down	Auto	Auto	Disabled
<input type="checkbox"/>	2	GE2	1000M Copper	Enabled	Down	Auto	Auto	Disabled
<input type="checkbox"/>	3	GE3	1000M Copper	Enabled	Down	Auto	Auto	Disabled
<input type="checkbox"/>	4	GE4	1000M Copper	Enabled	Down	Auto	Auto	Disabled
<input type="checkbox"/>	5	GE5	1000M Copper	Enabled	Down	Auto	Auto	Disabled
<input type="checkbox"/>	6	GE6	1000M Copper	Enabled	Down	Auto	Auto	Disabled
<input type="checkbox"/>	7	GE7	1000M Copper	Enabled	Down	Auto	Auto	Disabled
<input type="checkbox"/>	8	GE8	1000M Copper	Enabled	Down	Auto	Auto	Disabled
<input type="checkbox"/>	9	GE9	1000M Copper	Enabled	Down	Auto	Auto	Disabled
<input type="checkbox"/>	10	GE10	1000M Copper	Enabled	Down	Auto	Auto	Disabled
<input type="checkbox"/>	11	GE11	1000M Copper	Enabled	Down	Auto	Auto	Disabled
<input type="checkbox"/>	12	GE12	1000M Copper	Enabled	Down	Auto	Auto	Disabled
<input type="checkbox"/>	13	GE13	1000M Copper	Enabled	Down	Auto	Auto	Disabled
<input type="checkbox"/>	14	GE14	1000M Copper	Enabled	Down	Auto	Auto	Disabled
<input type="checkbox"/>	15	GE15	1000M Copper	Enabled	Down	Auto	Auto	Disabled
<input type="checkbox"/>	16	GE16	1000M Copper	Enabled	Down	Auto	Auto	Disabled
<input type="checkbox"/>	17	GE17	1000M Copper	Enabled	Down	Auto	Auto	Disabled
<input type="checkbox"/>	18	GE18	1000M Copper	Enabled	Down	Auto	Auto	Disabled
<input type="checkbox"/>	19	GE19	1000M Copper	Enabled	Down	Auto	Auto	Disabled
<input type="checkbox"/>	20	GE20	1000M Copper	Enabled	Down	Auto	Auto	Disabled
<input type="checkbox"/>	21	GE21	1000M Copper	Enabled	Down	Auto	Auto	Disabled
<input type="checkbox"/>	22	GE22	1000M Copper	Enabled	Down	Auto	Auto	Disabled
<input type="checkbox"/>	23	GE23	1000M Copper	Enabled	Down	Auto	Auto	Disabled
<input type="checkbox"/>	24	GE24	1000M Copper	Enabled	Down	Auto	Auto	Disabled
<input type="checkbox"/>	25	GE25	1000M Copper	Enabled	Down	Auto	Auto	Disabled
<input type="checkbox"/>	26	GE26	1000M Copper	Enabled	Down	Auto	Auto	Disabled
<input type="checkbox"/>	27	GE27	1000M Copper	Enabled	Down	Auto	Auto	Disabled
<input type="checkbox"/>	28	GE28	1000M Copper	Enabled	Down	Auto	Auto	Disabled
<input type="checkbox"/>	29	GE29	1000M Copper	Enabled	Down	Auto	Auto	Disabled
<input type="checkbox"/>	30	GE30	1000M Copper	Enabled	Down	Auto	Auto	Disabled
<input type="checkbox"/>	31	GE31	1000M Copper	Enabled	Down	Auto	Auto	Disabled
<input type="checkbox"/>	32	GE32	1000M Copper	Enabled	Down	Auto	Auto	Disabled
<input type="checkbox"/>	33	GE33	1000M Copper	Enabled	Down	Auto	Auto	Disabled
<input type="checkbox"/>	34	GE34	1000M Copper	Enabled	Down	Auto	Auto	Disabled
<input type="checkbox"/>	35	GE35	1000M Copper	Enabled	Down	Auto	Auto	Disabled
<input type="checkbox"/>	36	GE36	1000M Copper	Enabled	Down	Auto	Auto	Disabled
<input type="checkbox"/>	37	GE37	1000M Copper	Enabled	Down	Auto	Auto	Disabled
<input type="checkbox"/>	38	GE38	1000M Copper	Enabled	Down	Auto	Auto	Disabled
<input type="checkbox"/>	39	GE39	1000M Copper	Enabled	Down	Auto	Auto	Disabled
<input type="checkbox"/>	40	GE40	1000M Copper	Enabled	Down	Auto	Auto	Disabled
<input type="checkbox"/>	41	GE41	1000M Copper	Enabled	Down	Auto	Auto	Disabled
<input type="checkbox"/>	42	GE42	1000M Copper	Enabled	Down	Auto	Auto	Disabled
<input type="checkbox"/>	43	GE43	1000M Copper	Enabled	Down	Auto	Auto	Disabled
<input type="checkbox"/>	44	GE44	1000M Copper	Enabled	Down	Auto	Auto	Disabled
<input type="checkbox"/>	45	GE45	1000M Copper	Enabled	Down	Auto	Auto	Disabled
<input type="checkbox"/>	46	GE46	1000M Copper	Enabled	Down	Auto	Auto	Disabled
<input type="checkbox"/>	47	GE47	1000M Copper	Enabled	Down	Auto	Auto	Disabled
<input type="checkbox"/>	48	GE48	1000M Copper	Enabled	Up	Auto (1000M)	Auto (Full)	Disabled (Disabled)
<input type="checkbox"/>	49	10GE1	10G Fiber	Enabled	Down	Auto	Full	Disabled
<input type="checkbox"/>	50	10GE2	10G Fiber	Enabled	Down	Auto	Full	Disabled
<input type="checkbox"/>	51	10GE3	10G Fiber	Enabled	Down	Auto	Full	Disabled
<input type="checkbox"/>	52	10GE4	10G Fiber	Enabled	Down	Auto	Full	Disabled
<input type="checkbox"/>	53	10GE5	10G Fiber	Enabled	Down	Auto	Full	Disabled
<input type="checkbox"/>	54	10GE6	10G Fiber	Enabled	Down	Auto	Full	Disabled

Item	Description
Port	Port Name.

Type	Port media type.
Description	Port Description.
State	Port admin state <ul style="list-style-type: none"> ● Enabled: Enable the port. ● Disabled: Disable the port.
Link Status	Current port link status <ul style="list-style-type: none"> ● Up: Port is link up. ● Down: Port is link down.
Speed	Current port speed configuration and link speed status.
Duplex	Current port duplex configuration and link duplex status.
Flow Control	Current port flow control configuration and link flow control status.

Click **“Edit”** button to edit Port Setting menu

Edit Port Setting

Port	GE1
Description	<input style="width: 100%;" type="text"/>
State	<input checked="" type="checkbox"/> Enable
Speed	<input checked="" type="radio"/> Auto <input type="radio"/> 10M <input type="radio"/> Auto - 10M <input type="radio"/> 100M <input type="radio"/> Auto - 100M <input type="radio"/> 1000M <input type="radio"/> Auto - 1000M <input type="radio"/> Auto - 10M/100M
Duplex	<input checked="" type="radio"/> Auto <input type="radio"/> Full <input type="radio"/> Half
Flow Control	<input type="radio"/> Auto <input type="radio"/> Enable <input checked="" type="radio"/> Disable

Item	Description
Port	Selected Port list.
Description	Port media type.
State	Port admin state. <ul style="list-style-type: none"> ● Enabled: Enable the port. ● Disabled: Disable the port.

Speed	<p>Port speed capabilities.</p> <ul style="list-style-type: none"> ● Auto: Auto speed with all capabilities. ● Auto-10M: Auto speed with 10M ability only. ● Auto-100M: Auto speed with 100M ability only. ● Auto-1000M: Auto speed with 1000M ability only. ● Auto-10M/100M: Auto speed with 10M/100M abilities. ● 10M: Force speed with 10M ability. ● 100M: Force speed with 100M ability. ● 1000M: Force speed with 1000M ability.
Duplex	<p>Port duplex capabilities.</p> <ul style="list-style-type: none"> ● Auto: Auto duplex with all capabilities. ● Half: Auto speed with 10M and 100M ability only. ● Full: Auto speed with 10M/100M/1000M ability only.
Flow Control	<p>Port flow control.</p> <ul style="list-style-type: none"> ● Auto: Auto flow control by negotiation. ● Enabled: Enable flow control ability. ● Disabled: Disable flow control ability.

IV-3-2. Error Disable

To display Error Disabled web page, click **Port > Error Disabled**

Recovery Interval Sec (30 - 86400)

BPDU Guard	<input type="checkbox"/> Enable
UDLD	<input type="checkbox"/> Enable
Self Loop	<input type="checkbox"/> Enable
Broadcast Flood	<input type="checkbox"/> Enable
Unknown Multicast Flood	<input type="checkbox"/> Enable
Unicast Flood	<input type="checkbox"/> Enable
ACL	<input type="checkbox"/> Enable
Port Security	<input type="checkbox"/> Enable
DHCP Rate Limit	<input type="checkbox"/> Enable
ARP Rate Limit	<input type="checkbox"/> Enable

Item	Description
------	-------------

Recover Interval	Auto recovery after this interval for error disabled port.
BPDU Guard	Enabled to auto shutdown port when BPDU Guard reason occur. This reason caused by STP BPDU Guard mechanism.
UDLD	Enabled to auto shutdown port when UDLD violation occur.
Self Loop	Enabled to auto shutdown port when Self Loop reason occur.
Broadcast Flood	Enabled to auto shutdown port when Broadcast Flood reason occur. This reason caused by broadcast rate exceed broadcast storm control rate.
Unknown Multicast Flood	Enabled to auto shutdown port when Unknown Multicast Flood reason occur. This reason caused by unknown multicast rate exceed unknown multicast storm control rate.
Unicast Flood	Enabled to auto shutdown port when Unicast Flood reason occur. This reason caused by unicast rate exceed unicast storm control rate.
ACL	Enabled to auto shutdown port when ACL shutdown port reason occur. This reason caused packet match the ACL shutdown port action.
Port Security	Enabled to auto shutdown port when Port Security Violation reason occur. This reason caused by violation port security rules.
DHCP rate limit	Enabled to auto shutdown port when DHCP rate limit reason occur. This reason caused by DHCP packet rate exceed DHCP rate limit.
ARP rate limit	Enabled to auto shutdown port when ARP rate limit reason occur. This reason caused by DHCP packet rate exceed ARP rate limit.

IV-3-3. Link Aggregation

IV-3-3-1. Group

This page allow user to configure link aggregation group load balance algorithm and group member.

To view the Group menu, navigate to **Port > Link Aggregation > Group**.

Load Balance Algorithm
 MAC Address
 IP-MAC Address

Apply

Link Aggregation Table

Q

	LAG	Name	Type	Link Status	Active Member	Inactive Member
<input type="radio"/>	LAG 1		---	---		
<input type="radio"/>	LAG 2		---	---		
<input type="radio"/>	LAG 3		---	---		
<input type="radio"/>	LAG 4		---	---		
<input type="radio"/>	LAG 5		---	---		
<input type="radio"/>	LAG 6		---	---		
<input type="radio"/>	LAG 7		---	---		
<input type="radio"/>	LAG 8		---	---		

Edit

Item	Description
Load Balance Algorithm	LAG load balance distribution algorithm <ul style="list-style-type: none"> ● src-dst-mac: Based on MAC address. ● src-dst-mac-ip: Based on MAC address and IP address.
LAG	LAG Name.
Name	LAG port description.
Type	The type of the LAG <ul style="list-style-type: none"> ● Static: The group of ports assigned to a static LAG are always active members. ● LACP: The group of ports assigned to dynamic LAG are candidate ports. LACP determines which candidate ports are active member ports.
Link Status	LAG port link status
Active Member	Active member ports of the LAG.
Inactive Member	Inactive member ports of the LAG.

Click **“Edit”** to edit Link Aggregation Group menu.

Edit Link Aggregation Group

LAG	1						
Name	<input type="text"/>						
Type	<input checked="" type="radio"/> Static <input type="radio"/> LACP						
Member	<table border="0"> <tr> <td style="text-align: right;">Available Port</td> <td></td> <td style="text-align: left;">Selected Port</td> </tr> <tr> <td style="vertical-align: top;"> <div style="border: 1px solid gray; padding: 2px;"> GE1 GE2 GE3 GE4 GE5 GE6 GE7 GE8 </div> </td> <td style="text-align: center; vertical-align: middle;"> <input type="button" value="➤"/> <input type="button" value="➤"/> </td> <td style="vertical-align: top;"> <div style="border: 1px solid gray; padding: 2px; min-height: 100px;"> Selected Port </div> </td> </tr> </table>	Available Port		Selected Port	<div style="border: 1px solid gray; padding: 2px;"> GE1 GE2 GE3 GE4 GE5 GE6 GE7 GE8 </div>	<input type="button" value="➤"/> <input type="button" value="➤"/>	<div style="border: 1px solid gray; padding: 2px; min-height: 100px;"> Selected Port </div>
Available Port		Selected Port					
<div style="border: 1px solid gray; padding: 2px;"> GE1 GE2 GE3 GE4 GE5 GE6 GE7 GE8 </div>	<input type="button" value="➤"/> <input type="button" value="➤"/>	<div style="border: 1px solid gray; padding: 2px; min-height: 100px;"> Selected Port </div>					

Item	Description
LAG	Selected LAG group ID.
Name	LAG port description.
Type	The type of the LAG <ul style="list-style-type: none"> ● Static: The group of ports assigned to a static LAG are always active members. ● LACP: The group of ports assigned to dynamic LAG are candidate ports. LACP determines which candidate ports are active member ports.
Member	Select available port to be LAG group member port.

IV-3-3-2. Port Setting

This page shows LAG port current status and allow user to edit LAG port configurations. Select LAG entry and click “**Edit**” button to edit LAG port configurations.

To display LAG Port Setting web page, click **Port > Link Aggregation > Port Setting**.

Port Setting Table

<input type="checkbox"/>	LAG	Type	Description	State	Link Status	Speed	Duplex	Flow Control
<input type="checkbox"/>	LAG 1			Enabled	Down	Auto	Auto	Disabled
<input type="checkbox"/>	LAG 2			Enabled	Down	Auto	Auto	Disabled
<input type="checkbox"/>	LAG 3			Enabled	Down	Auto	Auto	Disabled
<input type="checkbox"/>	LAG 4			Enabled	Down	Auto	Auto	Disabled
<input type="checkbox"/>	LAG 5			Enabled	Down	Auto	Auto	Disabled
<input type="checkbox"/>	LAG 6			Enabled	Down	Auto	Auto	Disabled
<input type="checkbox"/>	LAG 7			Enabled	Down	Auto	Auto	Disabled
<input type="checkbox"/>	LAG 8			Enabled	Down	Auto	Auto	Disabled

Item	Description
LAG	LAG Port Name.
Type	LAG Port media type.
Description	LAG Port description.
State	LAG Port admin state <ul style="list-style-type: none"> ● Enabled: Enable the port. ● Disabled: Disable the port.
Link Status	Current LAG port link status <ul style="list-style-type: none"> ● Up: Port is link up. ● Down: Port is link down.
Speed	Current LAG port speed configuration and link speed status.
Duplex	Current LAG port duplex configuration and link duplex status.
Flow Control	Current LAG port flow control configuration and link flow control status.

Click “**Edit**” to view Edit Port Setting menu.

Edit Port Setting

Port	LAG1
Description	<input type="text"/>
State	<input checked="" type="checkbox"/> Enable
Speed	<input checked="" type="radio"/> Auto <input type="radio"/> Auto - 10M <input type="radio"/> Auto - 100M <input type="radio"/> Auto - 1000M <input type="radio"/> Auto - 10M/100M <input type="radio"/> 10M <input type="radio"/> 100M <input type="radio"/> 1000M
Flow Control	<input type="radio"/> Auto <input type="radio"/> Enable <input checked="" type="radio"/> Disable

Apply

Close

Item	Description
Port	Selected Port list.
Description	Port description.
State	Port admin state <ul style="list-style-type: none"> ● Enabled: Enable the port. ● Disabled: Disable the port.
Speed	Port speed capabilities <ul style="list-style-type: none"> ● Auto: Auto speed with all capabilities. ● Auto-10M: Auto speed with 10M ability only. ● Auto-100M: Auto speed with 100M ability only. ● Auto-1000M: Auto speed with 1000M ability only. ● Auto-10M/100M: Auto speed with 10M/100M abilities. ● 10M: Force speed with 10M ability. ● 100M: Force speed with 100M ability. ● 1000M: Force speed with 1000M ability.
Flow Control	Port flow control <ul style="list-style-type: none"> ● Auto: Auto flow control by negotiation. ● Enabled: Enable flow control ability. ● Disabled: Disable flow control ability.

IV-3-3-3. LACP

This page allow user to configure LACP global and port configurations. Select ports and click “**Edit**” button to edit port configuration.

To display the LACP Setting web page, click **Port > Link Aggregation > LACP**.

LACP Port Setting Table

Entry	Port	Port Priority	Timeout
<input type="checkbox"/>	1 GE1	1	Long
<input type="checkbox"/>	2 GE2	1	Long
<input type="checkbox"/>	3 GE3	1	Long
<input type="checkbox"/>	4 GE4	1	Long
<input type="checkbox"/>	5 GE5	1	Long
<input type="checkbox"/>	6 GE6	1	Long
<input type="checkbox"/>	7 GE7	1	Long
<input type="checkbox"/>	8 GE8	1	Long
<input type="checkbox"/>	9 GE9	1	Long
<input type="checkbox"/>	10 GE10	1	Long
<input type="checkbox"/>	11 GE11	1	Long
<input type="checkbox"/>	12 GE12	1	Long
<input type="checkbox"/>	13 GE13	1	Long
<input type="checkbox"/>	14 GE14	1	Long
<input type="checkbox"/>	15 GE15	1	Long
<input type="checkbox"/>	16 GE16	1	Long
<input type="checkbox"/>	17 GE17	1	Long
<input type="checkbox"/>	18 GE18	1	Long
<input type="checkbox"/>	19 GE19	1	Long
<input type="checkbox"/>	20 GE20	1	Long
<input type="checkbox"/>	21 GE21	1	Long
<input type="checkbox"/>	22 GE22	1	Long
<input type="checkbox"/>	23 GE23	1	Long
<input type="checkbox"/>	24 GE24	1	Long
<input type="checkbox"/>	25 GE25	1	Long
<input type="checkbox"/>	26 GE26	1	Long
<input type="checkbox"/>	27 GE27	1	Long
<input type="checkbox"/>	28 GE28	1	Long
<input type="checkbox"/>	29 GE29	1	Long
<input type="checkbox"/>	30 GE30	1	Long
<input type="checkbox"/>	32 GE32	1	Long
<input type="checkbox"/>	33 GE33	1	Long
<input type="checkbox"/>	34 GE34	1	Long
<input type="checkbox"/>	35 GE35	1	Long
<input type="checkbox"/>	36 GE36	1	Long
<input type="checkbox"/>	37 GE37	1	Long
<input type="checkbox"/>	38 GE38	1	Long
<input type="checkbox"/>	39 GE39	1	Long
<input type="checkbox"/>	40 GE40	1	Long
<input type="checkbox"/>	41 GE41	1	Long
<input type="checkbox"/>	42 GE42	1	Long
<input type="checkbox"/>	43 GE43	1	Long
<input type="checkbox"/>	44 GE44	1	Long
<input type="checkbox"/>	45 GE45	1	Long
<input type="checkbox"/>	46 GE46	1	Long
<input type="checkbox"/>	47 GE47	1	Long
<input type="checkbox"/>	48 GE48	1	Long
<input type="checkbox"/>	49 10GE1	1	Long
<input type="checkbox"/>	50 10GE2	1	Long
<input type="checkbox"/>	51 10GE3	1	Long
<input type="checkbox"/>	52 10GE4	1	Long
<input type="checkbox"/>	53 10GE5	1	Long
<input type="checkbox"/>	54 10GE6	1	Long

Item	Description
System Priority	Configure the system priority of LACP. This decides the system priority field in LACP PDU.
Port	Port Name.
Port Priority	LACP priority value of the port.
Timeout	The periodic transmissions type of LACP PDUs. <ul style="list-style-type: none"> ● Long: Transmit LACP PDU with slow periodic (30s). ● Short: Transmit LACPP DU with fast periodic (1s).

Click "Edit" button to view Edit LACP Port Setting menu.

Edit LACP Port Setting

Port	GE1
Port Priority	<input style="width: 100px;" type="text" value="1"/> (1 - 65535, default 1)
Timeout	<input checked="" type="radio"/> Long <input type="radio"/> Short

Item	Description
Port	Selected port list.
Port Priority	Enter the LACP priority value of the port
Timeout	The periodic transmissions type of LACP PDUs. <ul style="list-style-type: none"> ● Long: Transmit LACP PDU with slow periodic (30s). ● Short: Transmit LACPP DU with fast periodic (1s).

IV-3-3-4. EEE

This page allow user to configure Energy Efficient Ethernet settings.

To display the EEE web page, click **Port > EEE**.

Entry	Port	State	Operational Status
<input type="checkbox"/>	1 GE1	Disabled	Disabled
<input type="checkbox"/>	2 GE2	Disabled	Disabled
<input type="checkbox"/>	3 GE3	Disabled	Disabled
<input type="checkbox"/>	4 GE4	Disabled	Disabled
<input type="checkbox"/>	5 GE5	Disabled	Disabled
<input type="checkbox"/>	6 GE6	Disabled	Disabled
<input type="checkbox"/>	7 GE7	Disabled	Disabled
<input type="checkbox"/>	8 GE8	Disabled	Disabled
<input type="checkbox"/>	9 GE9	Disabled	Disabled
<input type="checkbox"/>	10 GE10	Disabled	Disabled
<input type="checkbox"/>	11 GE11	Disabled	Disabled
<input type="checkbox"/>	12 GE12	Disabled	Disabled
<input type="checkbox"/>	13 GE13	Disabled	Disabled
<input type="checkbox"/>	14 GE14	Disabled	Disabled
<input type="checkbox"/>	15 GE15	Disabled	Disabled
<input type="checkbox"/>	16 GE16	Disabled	Disabled
<input type="checkbox"/>	17 GE17	Disabled	Disabled
<input type="checkbox"/>	18 GE18	Disabled	Disabled
<input type="checkbox"/>	19 GE19	Disabled	Disabled
<input type="checkbox"/>	20 GE20	Disabled	Disabled
<input type="checkbox"/>	21 GE21	Disabled	Disabled
<input type="checkbox"/>	22 GE22	Disabled	Disabled
<input type="checkbox"/>	23 GE23	Disabled	Disabled
<input type="checkbox"/>	24 GE24	Disabled	Disabled
<input type="checkbox"/>	25 GE25	Disabled	Disabled
<input type="checkbox"/>	26 GE26	Disabled	Disabled
<input type="checkbox"/>	27 GE27	Disabled	Disabled
<input type="checkbox"/>	28 GE28	Disabled	Disabled
<input type="checkbox"/>	29 GE29	Disabled	Disabled
<input type="checkbox"/>	30 GE30	Disabled	Disabled
<input type="checkbox"/>	31 GE31	Disabled	Disabled
<input type="checkbox"/>	32 GE32	Disabled	Disabled
<input type="checkbox"/>	33 GE33	Disabled	Disabled

<input type="checkbox"/>	33	GE33	Disabled	Disabled
<input type="checkbox"/>	34	GE34	Disabled	Disabled
<input type="checkbox"/>	35	GE35	Disabled	Disabled
<input type="checkbox"/>	36	GE36	Disabled	Disabled
<input type="checkbox"/>	37	GE37	Disabled	Disabled
<input type="checkbox"/>	38	GE38	Disabled	Disabled
<input type="checkbox"/>	39	GE39	Disabled	Disabled
<input type="checkbox"/>	40	GE40	Disabled	Disabled
<input type="checkbox"/>	41	GE41	Disabled	Disabled
<input type="checkbox"/>	42	GE42	Disabled	Disabled
<input type="checkbox"/>	43	GE43	Disabled	Disabled
<input type="checkbox"/>	44	GE44	Disabled	Disabled
<input type="checkbox"/>	45	GE45	Disabled	Disabled
<input type="checkbox"/>	46	GE46	Disabled	Disabled
<input type="checkbox"/>	47	GE47	Disabled	Disabled
<input type="checkbox"/>	48	GE48	Disabled	Disabled

[Edit](#)

Item	Description
Port	Port Name.
State	Port EEE admin state <ul style="list-style-type: none"> ● Enabled: EEE is enabled. ● Disabled: EEE is disabled.
Operational Status	Port EEE operational status <ul style="list-style-type: none"> ● Enabled: EEE is operating. ● Disabled: EEE is no operating.

Click **“Edit”** to edit the EEE menu.

Edit EEE Setting

Port	GE1
State	<input type="checkbox"/> Enable

[Apply](#) [Close](#)

Item	Description
Port	Port Name
State	Port EEE admin state <ul style="list-style-type: none"> ● Enabled: EEE is enabled. ● Disabled: EEE is disabled.

IV-3-4. Jumbo Frame

This page allow user to configure switch jumbo frame size.

To display Jumbo Frame web page, click **Port > Jumbo Frame**.

Jumbo Frame	<input checked="" type="checkbox"/> Enable
	<input style="width: 150px;" type="text" value="1522"/> Byte (1518 - 10000, default 1522)

Apply

Item	Description
Jumbo Frame	Enable or disable jumbo frame. When jumbo frame is enabled, switch max frame size is allowed to configure. When jumbo frame is disabled, default frame size 1522 will be used.

IV-4. PoE

Port security can set port isolation and specific behavior.

NOTE: This section is only for GS-5654PLX V2.

IV-4-1. Global Setting

To display the Global web page, click **PoE > Global Setting**.

Nominal Power	400 W
Consuming Power	0 W
Remaining Power	400 W
Schedule Status	Disable ▾

Apply

PoE Schedule Table

Q

<input type="checkbox"/>	Index	Name	Port List	Schedule Status
<input type="checkbox"/>	1	Index_01		Disable
<input type="checkbox"/>	2	Index_02		Disable
<input type="checkbox"/>	3	Index_03		Disable
<input type="checkbox"/>	4	Index_04		Disable
<input type="checkbox"/>	5	Index_05		Disable
<input type="checkbox"/>	6	Index_06		Disable
<input type="checkbox"/>	7	Index_07		Disable
<input type="checkbox"/>	8	Index_08		Disable
<input type="checkbox"/>	9	Index_09		Disable
<input type="checkbox"/>	10	Index_10		Disable
<input type="checkbox"/>	11	Index_11		Disable
<input type="checkbox"/>	12	Index_12		Disable
<input type="checkbox"/>	13	Index_13		Disable
<input type="checkbox"/>	14	Index_14		Disable
<input type="checkbox"/>	15	Index_15		Disable
<input type="checkbox"/>	16	Index_16		Disable
<input type="checkbox"/>	17	Index_17		Disable
<input type="checkbox"/>	18	Index_18		Disable
<input type="checkbox"/>	19	Index_19		Disable
<input type="checkbox"/>	20	Index_20		Disable
<input type="checkbox"/>	21	Index_21		Disable
<input type="checkbox"/>	22	Index_22		Disable
<input type="checkbox"/>	23	Index_23		Disable
<input type="checkbox"/>	24	Index_24		Disable

Edit

Item	Description
Nominal Power	Maximum supply power.
Consuming Power	Current consumed power.
Remaining Power	Remaining available power.
Schedule Status	Schedule status global switch.
Name	PoE Schedule Name.
Port List	The ports provide power in designated schedule index.
Schedule Status	The current schedule status.

Click **“Edit”** to view PoE Schedule List menu.

PoE Schedule Edit

Index:

Schedule Status: Enable

Name:

Date: Mon Tue Wed Thu Fri Sat Sun
 From to

Port List

Item	Description
Index	The serial number of schedule list.
Schedule Status	Schedule Status <ul style="list-style-type: none"> ● Checked: Schedule status is enabled. ● Unchecked: Schedule status is disabled.
Name	Enter the PoE schedule name.
Date	Select a valid time for this schedule.
Port List	Select the port provide power.

IV-4-2. Priority Setting

There are 3 levels of priority you can choose for each port which are critical, high and low. Total power budget of the switch is 400W, if one of the ports selected Critical Priority then this port will get the power from the switch first if the total power exceeds 400W.

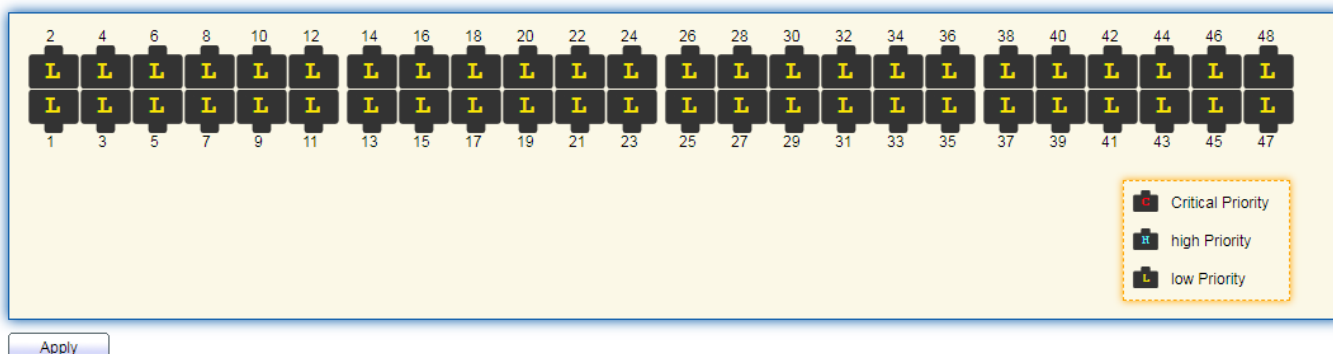

IV-4-3. Power Limit

This page shows the information of each ports, including power limit.

PD Alive Check Table

Entry	Port	Mode	ping PD IP Address	Interval Time	Retry Count	Action	Reboot Time	Connect Status	
<input type="checkbox"/>	1	GE1	Disable	0.0.0.0	30	2	None	90	Off
<input type="checkbox"/>	2	GE2	Disable	0.0.0.0	30	2	None	90	Off
<input type="checkbox"/>	3	GE3	Disable	0.0.0.0	30	2	None	90	Off
<input type="checkbox"/>	4	GE4	Disable	0.0.0.0	30	2	None	90	Off
<input type="checkbox"/>	5	GE5	Disable	0.0.0.0	30	2	None	90	Off
<input type="checkbox"/>	6	GE6	Disable	0.0.0.0	30	2	None	90	Off
<input type="checkbox"/>	7	GE7	Disable	0.0.0.0	30	2	None	90	Off
<input type="checkbox"/>	8	GE8	Disable	0.0.0.0	30	2	None	90	Off
<input type="checkbox"/>	9	GE9	Disable	0.0.0.0	30	2	None	90	Off
<input type="checkbox"/>	10	GE10	Disable	0.0.0.0	30	2	None	90	Off
<input type="checkbox"/>	11	GE11	Disable	0.0.0.0	30	2	None	90	Off
<input type="checkbox"/>	12	GE12	Disable	0.0.0.0	30	2	None	90	Off
<input type="checkbox"/>	13	GE13	Disable	0.0.0.0	30	2	None	90	Off
<input type="checkbox"/>	14	GE14	Disable	0.0.0.0	30	2	None	90	Off
<input type="checkbox"/>	15	GE15	Disable	0.0.0.0	30	2	None	90	Off
<input type="checkbox"/>	16	GE16	Disable	0.0.0.0	30	2	None	90	Off

To display port setting page, please click the “Edit” button.

Power Limit Setting Table

Port List	GE1
Power Limit	<input type="text" value="30000"/> mW (0 - 30000, default 30000)

Item	Description
Port list	Display the interface of port entry.
Power Limit	Specify the power limit (0-30000, default 30000)

IV-4-4. PoE Status

The interface displays 48 ports arranged in two rows of 24. The top row ports are numbered 2, 4, 6, 8, 10, 12, 14, 16, 18, 20, 22, 24, 26, 28, 30, 32, 34, 36, 38, 40, 42, 44, 46, 48. The bottom row ports are numbered 1, 3, 5, 7, 9, 11, 13, 15, 17, 19, 21, 23, 25, 27, 29, 31, 33, 35, 37, 39, 41, 43, 45, 47. Ports 1-24 have a yellow checkmark icon, indicating they are enabled. Ports 25-48 have a grey square icon, indicating they are disabled. Below the port grid are two buttons: 'Enable' (with a checkmark icon) and 'Disable' (with a square icon). A legend on the right shows a grey square for 'Disabled' and a yellow checkmark for 'Enabled'.

Port	Status	PD Class	Max Power	Consuming Power	Priority	
1	GE1	Off	N/A	0 mW	0 mW	Low
2	GE2	Off	N/A	0 mW	0 mW	Critical
3	GE3	Off	N/A	0 mW	0 mW	Low
4	GE4	Off	N/A	0 mW	0 mW	Low
5	GE5	Off	N/A	0 mW	0 mW	High
6	GE6	Off	N/A	0 mW	0 mW	Low
7	GE7	Off	N/A	0 mW	0 mW	Low
8	GE8	Off	N/A	0 mW	0 mW	Low
9	GE9	Off	N/A	0 mW	0 mW	Low
10	GE10	Off	N/A	0 mW	0 mW	Low
11	GE11	Off	N/A	0 mW	0 mW	Low
12	GE12	Off	N/A	0 mW	0 mW	Low
13	GE13	Off	N/A	0 mW	0 mW	Low
14	GE14	Off	N/A	0 mW	0 mW	Low
15	GE15	Off	N/A	0 mW	0 mW	Low
16	GE16	Off	N/A	0 mW	0 mW	Low
17	GE17	Off	N/A	0 mW	0 mW	Low
18	GE18	Off	N/A	0 mW	0 mW	Low
19	GE19	Off	N/A	0 mW	0 mW	Low
20	GE20	Off	N/A	0 mW	0 mW	Low
21	GE21	Off	N/A	0 mW	0 mW	Low
22	GE22	Off	N/A	0 mW	0 mW	Low
23	GE23	Off	N/A	0 mW	0 mW	Low
24	GE24	Off	N/A	0 mW	0 mW	Low
25	GE25	Off	N/A	0 mW	0 mW	Low
26	GE26	Off	N/A	0 mW	0 mW	Low
27	GE27	Off	N/A	0 mW	0 mW	Low
28	GE28	Off	N/A	0 mW	0 mW	Low
29	GE29	Off	N/A	0 mW	0 mW	Low
30	GE30	Off	N/A	0 mW	0 mW	Low

31	GE31	Off	N/A	0 mW	0 mW	Low
32	GE32	Off	N/A	0 mW	0 mW	Low
33	GE33	Off	N/A	0 mW	0 mW	Low
34	GE34	Off	N/A	0 mW	0 mW	Low
35	GE35	Off	N/A	0 mW	0 mW	Low
36	GE36	Off	N/A	0 mW	0 mW	Low
37	GE37	Off	N/A	0 mW	0 mW	Low
38	GE38	Off	N/A	0 mW	0 mW	Low
39	GE39	Off	N/A	0 mW	0 mW	Low
40	GE40	Off	N/A	0 mW	0 mW	Low
41	GE41	Off	N/A	0 mW	0 mW	Low
42	GE42	Off	N/A	0 mW	0 mW	Low
43	GE43	Off	N/A	0 mW	0 mW	Low
44	GE44	Off	N/A	0 mW	0 mW	Low
45	GE45	Off	N/A	0 mW	0 mW	Low
46	GE46	Off	N/A	0 mW	0 mW	Low
47	GE47	Off	N/A	0 mW	0 mW	Low
48	GE48	Off	N/A	0 mW	0 mW	Low

Refresh

Per Port PoE Status

Checked: Port PoE status is enabled.

Unchecked: Port PoE status is disabled.

IV-5. VLAN

A virtual local area network, virtual LAN or VLAN, is a group of hosts with a common set of requirements that communicate as if they were attached to the same broadcast domain, regardless of their physical location. A VLAN has the same attributes as a physical local area network (LAN), but it allows for end stations to be grouped together even if they are not located on the same network switch. VLAN membership can be configured through software instead of physically relocating devices or connections.

IV-5-1. VLAN

Use the VLAN pages to configure settings of VLAN.

IV-5-1-1. Create VLAN

This page allows user to add or delete VLAN ID entries and browser all VLAN entries that add statically or dynamic learned by GVRP. Each VLAN entry has a unique name, user can edit VLAN name in edit page.

To display Create VLAN page, click **VLAN > VLAN > Create VLAN**.

VLAN

Available VLAN

- VLAN 2
- VLAN 3
- VLAN 4
- VLAN 5
- VLAN 6
- VLAN 7
- VLAN 8
- VLAN 9

Created VLAN

- VLAN 1

VLAN Table

Showing All entries Showing 1 to 1 of 1 entries

<input type="checkbox"/>	VLAN	Name	Type
<input type="checkbox"/>	1	default	Default

Item	Description
Available VLAN	VLAN has not created yet. Select available VLANs from left box then move to right box to add.
Created VLAN	VLAN had been created. Select created VLANs from right box then move to left box to delete
VLAN	The VLAN ID.
Name	The VLAN Name.
Type	The VLAN Type. <ul style="list-style-type: none"> ● Static: Port base VLAN. ● Dynamic: 802.1q VLAN.

Click **“Edit”** button to view Edit VLAN Name menu.

Edit VLAN Name

Name

Item	Description
Name	Input VLAN name.

IV-5-1-2. VLAN Configuration

This page allow user to configure the membership for each port of selected VLAN.

To display VLAN Configuration page, click **VLAN > VLAN > VLAN Configuration**.

Entry	Port	Mode	Membership				PVID
1	GE1	Trunk	<input type="radio"/> Excluded	<input type="radio"/> Forbidden	<input type="radio"/> Tagged	<input checked="" type="radio"/> Untagged	<input checked="" type="checkbox"/>
2	GE2	Trunk	<input type="radio"/> Excluded	<input type="radio"/> Forbidden	<input type="radio"/> Tagged	<input checked="" type="radio"/> Untagged	<input checked="" type="checkbox"/>
3	GE3	Trunk	<input type="radio"/> Excluded	<input type="radio"/> Forbidden	<input type="radio"/> Tagged	<input checked="" type="radio"/> Untagged	<input checked="" type="checkbox"/>
4	GE4	Trunk	<input type="radio"/> Excluded	<input type="radio"/> Forbidden	<input type="radio"/> Tagged	<input checked="" type="radio"/> Untagged	<input checked="" type="checkbox"/>
5	GE5	Trunk	<input type="radio"/> Excluded	<input type="radio"/> Forbidden	<input type="radio"/> Tagged	<input checked="" type="radio"/> Untagged	<input checked="" type="checkbox"/>
6	GE6	Trunk	<input type="radio"/> Excluded	<input type="radio"/> Forbidden	<input type="radio"/> Tagged	<input checked="" type="radio"/> Untagged	<input checked="" type="checkbox"/>
7	GE7	Trunk	<input type="radio"/> Excluded	<input type="radio"/> Forbidden	<input type="radio"/> Tagged	<input checked="" type="radio"/> Untagged	<input checked="" type="checkbox"/>
8	GE8	Trunk	<input type="radio"/> Excluded	<input type="radio"/> Forbidden	<input type="radio"/> Tagged	<input checked="" type="radio"/> Untagged	<input checked="" type="checkbox"/>
9	GE9	Trunk	<input type="radio"/> Excluded	<input type="radio"/> Forbidden	<input type="radio"/> Tagged	<input checked="" type="radio"/> Untagged	<input checked="" type="checkbox"/>
10	GE10	Trunk	<input type="radio"/> Excluded	<input type="radio"/> Forbidden	<input type="radio"/> Tagged	<input checked="" type="radio"/> Untagged	<input checked="" type="checkbox"/>
11	GE11	Trunk	<input type="radio"/> Excluded	<input type="radio"/> Forbidden	<input type="radio"/> Tagged	<input checked="" type="radio"/> Untagged	<input checked="" type="checkbox"/>
12	GE12	Trunk	<input type="radio"/> Excluded	<input type="radio"/> Forbidden	<input type="radio"/> Tagged	<input checked="" type="radio"/> Untagged	<input checked="" type="checkbox"/>
13	GE13	Trunk	<input type="radio"/> Excluded	<input type="radio"/> Forbidden	<input type="radio"/> Tagged	<input checked="" type="radio"/> Untagged	<input checked="" type="checkbox"/>
14	GE14	Trunk	<input type="radio"/> Excluded	<input type="radio"/> Forbidden	<input type="radio"/> Tagged	<input checked="" type="radio"/> Untagged	<input checked="" type="checkbox"/>
15	GE15	Trunk	<input type="radio"/> Excluded	<input type="radio"/> Forbidden	<input type="radio"/> Tagged	<input checked="" type="radio"/> Untagged	<input checked="" type="checkbox"/>
16	GE16	Trunk	<input type="radio"/> Excluded	<input type="radio"/> Forbidden	<input type="radio"/> Tagged	<input checked="" type="radio"/> Untagged	<input checked="" type="checkbox"/>
17	GE17	Trunk	<input type="radio"/> Excluded	<input type="radio"/> Forbidden	<input type="radio"/> Tagged	<input checked="" type="radio"/> Untagged	<input checked="" type="checkbox"/>
18	GE18	Trunk	<input type="radio"/> Excluded	<input type="radio"/> Forbidden	<input type="radio"/> Tagged	<input checked="" type="radio"/> Untagged	<input checked="" type="checkbox"/>
19	GE19	Trunk	<input type="radio"/> Excluded	<input type="radio"/> Forbidden	<input type="radio"/> Tagged	<input checked="" type="radio"/> Untagged	<input checked="" type="checkbox"/>
20	GE20	Trunk	<input type="radio"/> Excluded	<input type="radio"/> Forbidden	<input type="radio"/> Tagged	<input checked="" type="radio"/> Untagged	<input checked="" type="checkbox"/>
21	GE21	Trunk	<input type="radio"/> Excluded	<input type="radio"/> Forbidden	<input type="radio"/> Tagged	<input checked="" type="radio"/> Untagged	<input checked="" type="checkbox"/>
22	GE22	Trunk	<input type="radio"/> Excluded	<input type="radio"/> Forbidden	<input type="radio"/> Tagged	<input checked="" type="radio"/> Untagged	<input checked="" type="checkbox"/>
23	GE23	Trunk	<input type="radio"/> Excluded	<input type="radio"/> Forbidden	<input type="radio"/> Tagged	<input checked="" type="radio"/> Untagged	<input checked="" type="checkbox"/>
24	GE24	Trunk	<input type="radio"/> Excluded	<input type="radio"/> Forbidden	<input type="radio"/> Tagged	<input checked="" type="radio"/> Untagged	<input checked="" type="checkbox"/>
25	GE25	Trunk	<input type="radio"/> Excluded	<input type="radio"/> Forbidden	<input type="radio"/> Tagged	<input checked="" type="radio"/> Untagged	<input checked="" type="checkbox"/>
26	GE26	Trunk	<input type="radio"/> Excluded	<input type="radio"/> Forbidden	<input type="radio"/> Tagged	<input checked="" type="radio"/> Untagged	<input checked="" type="checkbox"/>
27	GE27	Trunk	<input type="radio"/> Excluded	<input type="radio"/> Forbidden	<input type="radio"/> Tagged	<input checked="" type="radio"/> Untagged	<input checked="" type="checkbox"/>
28	GE28	Trunk	<input type="radio"/> Excluded	<input type="radio"/> Forbidden	<input type="radio"/> Tagged	<input checked="" type="radio"/> Untagged	<input checked="" type="checkbox"/>
29	GE29	Trunk	<input type="radio"/> Excluded	<input type="radio"/> Forbidden	<input type="radio"/> Tagged	<input checked="" type="radio"/> Untagged	<input checked="" type="checkbox"/>
30	GE30	Trunk	<input type="radio"/> Excluded	<input type="radio"/> Forbidden	<input type="radio"/> Tagged	<input checked="" type="radio"/> Untagged	<input checked="" type="checkbox"/>
31	GE31	Trunk	<input type="radio"/> Excluded	<input type="radio"/> Forbidden	<input type="radio"/> Tagged	<input checked="" type="radio"/> Untagged	<input checked="" type="checkbox"/>
32	GE32	Trunk	<input type="radio"/> Excluded	<input type="radio"/> Forbidden	<input type="radio"/> Tagged	<input checked="" type="radio"/> Untagged	<input checked="" type="checkbox"/>
33	GE33	Trunk	<input type="radio"/> Excluded	<input type="radio"/> Forbidden	<input type="radio"/> Tagged	<input checked="" type="radio"/> Untagged	<input checked="" type="checkbox"/>
34	GE34	Trunk	<input type="radio"/> Excluded	<input type="radio"/> Forbidden	<input type="radio"/> Tagged	<input checked="" type="radio"/> Untagged	<input checked="" type="checkbox"/>
35	GE35	Trunk	<input type="radio"/> Excluded	<input type="radio"/> Forbidden	<input type="radio"/> Tagged	<input checked="" type="radio"/> Untagged	<input checked="" type="checkbox"/>
36	GE36	Trunk	<input type="radio"/> Excluded	<input type="radio"/> Forbidden	<input type="radio"/> Tagged	<input checked="" type="radio"/> Untagged	<input checked="" type="checkbox"/>
37	GE37	Trunk	<input type="radio"/> Excluded	<input type="radio"/> Forbidden	<input type="radio"/> Tagged	<input checked="" type="radio"/> Untagged	<input checked="" type="checkbox"/>
38	GE38	Trunk	<input type="radio"/> Excluded	<input type="radio"/> Forbidden	<input type="radio"/> Tagged	<input checked="" type="radio"/> Untagged	<input checked="" type="checkbox"/>
39	GE39	Trunk	<input type="radio"/> Excluded	<input type="radio"/> Forbidden	<input type="radio"/> Tagged	<input checked="" type="radio"/> Untagged	<input checked="" type="checkbox"/>
40	GE40	Trunk	<input type="radio"/> Excluded	<input type="radio"/> Forbidden	<input type="radio"/> Tagged	<input checked="" type="radio"/> Untagged	<input checked="" type="checkbox"/>
41	GE41	Trunk	<input type="radio"/> Excluded	<input type="radio"/> Forbidden	<input type="radio"/> Tagged	<input checked="" type="radio"/> Untagged	<input checked="" type="checkbox"/>
42	GE42	Trunk	<input type="radio"/> Excluded	<input type="radio"/> Forbidden	<input type="radio"/> Tagged	<input checked="" type="radio"/> Untagged	<input checked="" type="checkbox"/>
43	GE43	Trunk	<input type="radio"/> Excluded	<input type="radio"/> Forbidden	<input type="radio"/> Tagged	<input checked="" type="radio"/> Untagged	<input checked="" type="checkbox"/>
44	GE44	Trunk	<input type="radio"/> Excluded	<input type="radio"/> Forbidden	<input type="radio"/> Tagged	<input checked="" type="radio"/> Untagged	<input checked="" type="checkbox"/>
45	GE45	Trunk	<input type="radio"/> Excluded	<input type="radio"/> Forbidden	<input type="radio"/> Tagged	<input checked="" type="radio"/> Untagged	<input checked="" type="checkbox"/>
46	GE46	Trunk	<input type="radio"/> Excluded	<input type="radio"/> Forbidden	<input type="radio"/> Tagged	<input checked="" type="radio"/> Untagged	<input checked="" type="checkbox"/>
47	GE47	Trunk	<input type="radio"/> Excluded	<input type="radio"/> Forbidden	<input type="radio"/> Tagged	<input checked="" type="radio"/> Untagged	<input checked="" type="checkbox"/>
48	GE48	Trunk	<input type="radio"/> Excluded	<input type="radio"/> Forbidden	<input type="radio"/> Tagged	<input checked="" type="radio"/> Untagged	<input checked="" type="checkbox"/>
49	10GE1	Trunk	<input type="radio"/> Excluded	<input type="radio"/> Forbidden	<input type="radio"/> Tagged	<input checked="" type="radio"/> Untagged	<input checked="" type="checkbox"/>
50	10GE2	Trunk	<input type="radio"/> Excluded	<input type="radio"/> Forbidden	<input type="radio"/> Tagged	<input checked="" type="radio"/> Untagged	<input checked="" type="checkbox"/>
51	10GE3	Trunk	<input type="radio"/> Excluded	<input type="radio"/> Forbidden	<input type="radio"/> Tagged	<input checked="" type="radio"/> Untagged	<input checked="" type="checkbox"/>
52	10GE4	Trunk	<input type="radio"/> Excluded	<input type="radio"/> Forbidden	<input type="radio"/> Tagged	<input checked="" type="radio"/> Untagged	<input checked="" type="checkbox"/>
53	10GE5	Trunk	<input type="radio"/> Excluded	<input type="radio"/> Forbidden	<input type="radio"/> Tagged	<input checked="" type="radio"/> Untagged	<input checked="" type="checkbox"/>
54	10GE6	Trunk	<input type="radio"/> Excluded	<input type="radio"/> Forbidden	<input type="radio"/> Tagged	<input checked="" type="radio"/> Untagged	<input checked="" type="checkbox"/>
55	LAG1	Trunk	<input type="radio"/> Excluded	<input type="radio"/> Forbidden	<input type="radio"/> Tagged	<input checked="" type="radio"/> Untagged	<input checked="" type="checkbox"/>
56	LAG2	Trunk	<input type="radio"/> Excluded	<input type="radio"/> Forbidden	<input type="radio"/> Tagged	<input checked="" type="radio"/> Untagged	<input checked="" type="checkbox"/>
57	LAG3	Trunk	<input type="radio"/> Excluded	<input type="radio"/> Forbidden	<input type="radio"/> Tagged	<input checked="" type="radio"/> Untagged	<input checked="" type="checkbox"/>
58	LAG4	Trunk	<input type="radio"/> Excluded	<input type="radio"/> Forbidden	<input type="radio"/> Tagged	<input checked="" type="radio"/> Untagged	<input checked="" type="checkbox"/>
59	LAG5	Trunk	<input type="radio"/> Excluded	<input type="radio"/> Forbidden	<input type="radio"/> Tagged	<input checked="" type="radio"/> Untagged	<input checked="" type="checkbox"/>
60	LAG6	Trunk	<input type="radio"/> Excluded	<input type="radio"/> Forbidden	<input type="radio"/> Tagged	<input checked="" type="radio"/> Untagged	<input checked="" type="checkbox"/>
61	LAG7	Trunk	<input type="radio"/> Excluded	<input type="radio"/> Forbidden	<input type="radio"/> Tagged	<input checked="" type="radio"/> Untagged	<input checked="" type="checkbox"/>

Item	Description
VLAN	Select specified VLAN ID to configure VLAN configuration.
Port	Display the interface of port entry.
Mode	Display the interface VLAN mode of port.
Membership	Select the membership for this port of the specified VLAN ID. <ul style="list-style-type: none"> ● Forbidden: Specify the port is forbidden in the VLAN. ● Excluded: Specify the port is excluded in the VLAN. ● Tagged: Specify the port is tagged member in the VLAN. ● Untagged: Specify the port is untagged member in the VLAN.
PVID	Display if it is PVID of interface.

IV-5-1-3. Membership

This page allow user to view membership information for each port and edit membership for specified interface.

To display Membership page, click **VLAN > VLAN > Membership**.

Membership Table

Entry	Port	Mode	Administrative VLAN	Operational VLAN
1	GE1	Trunk	1UP	1UP
2	GE2	Trunk	1UP	1UP
3	GE3	Trunk	1UP	1UP
4	GE4	Trunk	1UP	1UP
5	GE5	Trunk	1UP	1UP
6	GE6	Hybrid	1U, 3UP	1U, 3UP
7	GE7	Trunk	1UP	1UP
8	GE8	Hybrid	1UP	1UP
9	GE9	Trunk	1UP	1UP
10	GE10	Trunk	1UP	1UP
11	GE11	Trunk	1UP	1UP
12	GE12	Trunk	1UP	1UP
13	GE13	Trunk	1UP	1UP
14	GE14	Trunk	1UP	1UP
15	GE15	Trunk	1UP	1UP
16	GE16	Trunk	1UP	1UP
17	GE17	Trunk	1UP	1UP
18	GE18	Trunk	1UP	1UP
19	GE19	Trunk	1UP	1UP
20	GE20	Trunk	1UP	1UP
21	GE21	Trunk	1UP	1UP
22	GE22	Trunk	1UP	1UP

Item	Description
Port	Display the interface of port entry.
Mode	Display the interface VLAN mode of port.
Administrative VLAN	Display the administrative VLAN list of this port.
Operational VLAN	Display the operational VLAN list of this port. Operational VLAN means the VLAN status that really runs in device. It may different to administrative VLAN.

Click "**Edit**" button to view the Edit Port Setting menu

Edit Port Setting

The screenshot shows the 'Edit Port Setting' interface. The 'Port' field is set to 'GE1' and the 'Mode' is 'Trunk'. The 'Membership' section features two lists of VLANs: the left list contains '2' and the right list contains '1UP'. Between these lists are right and left arrow buttons for moving VLANs. Below the lists, there are radio buttons for membership types: 'Forbidden', 'Excluded', 'Tagged' (which is selected), and 'Untagged'. There is also a 'PVID' checkbox. At the bottom of the window are 'Apply' and 'Close' buttons.

Item	Description
Port	Display the interface.
Mode	Display the VLAN mode of interface.
Membership	<p>Select VLANs of left box and select one of following membership then move to right box to add membership. Select VLANs of right box then move to left box to remove membership. Tagging membership may not choose in differ VLAN port mode. Select the time source.</p> <ul style="list-style-type: none"> ● Forbidden: Set VLAN as forbidden VLAN. ● Excluded: This option is always disabled. ● Tagged: Set VLAN as tagged VLAN. ● Untagged: Set VLAN as untagged VLAN. ● PVID: Check this checkbox to select the VLAN ID to be the port-based VLAN ID for this port. PVID may auto select or can't select in differ settings.

IV-5-1-4. Port Setting

This page allow user to configure ports VLAN settings such as VLAN port mode, PVID etc...The attributes depend on different VLAN port mode.

To display Port Setting page, click **VLAN > VLAN > Port Setting**.

Entry	Port	Mode	PVID	Accept Frame Type	Ingress Filtering	Uplink	TPID	
<input type="checkbox"/>	1	GE1	Trunk	1	All	Enabled	Disabled	0x8100
<input type="checkbox"/>	2	GE2	Trunk	1	All	Enabled	Disabled	0x8100
<input type="checkbox"/>	3	GE3	Trunk	1	All	Enabled	Disabled	0x8100
<input type="checkbox"/>	4	GE4	Trunk	1	All	Enabled	Disabled	0x8100
<input type="checkbox"/>	5	GE5	Trunk	1	All	Enabled	Disabled	0x8100
<input type="checkbox"/>	6	GE6	Trunk	1	All	Enabled	Disabled	0x8100
<input type="checkbox"/>	7	GE7	Trunk	1	All	Enabled	Disabled	0x8100
<input type="checkbox"/>	8	GE8	Trunk	1	All	Enabled	Disabled	0x8100
<input type="checkbox"/>	9	GE9	Trunk	1	All	Enabled	Disabled	0x8100
<input type="checkbox"/>	10	GE10	Trunk	1	All	Enabled	Disabled	0x8100
<input type="checkbox"/>	11	GE11	Trunk	1	All	Enabled	Disabled	0x8100
<input type="checkbox"/>	12	GE12	Trunk	1	All	Enabled	Disabled	0x8100
<input type="checkbox"/>	13	GE13	Trunk	1	All	Enabled	Disabled	0x8100
<input type="checkbox"/>	14	GE14	Trunk	1	All	Enabled	Disabled	0x8100
<input type="checkbox"/>	15	GE15	Trunk	1	All	Enabled	Disabled	0x8100
<input type="checkbox"/>	16	GE16	Trunk	1	All	Enabled	Disabled	0x8100
<input type="checkbox"/>	17	GE17	Trunk	1	All	Enabled	Disabled	0x8100
<input type="checkbox"/>	18	GE18	Trunk	1	All	Enabled	Disabled	0x8100
<input type="checkbox"/>	19	GE19	Trunk	1	All	Enabled	Disabled	0x8100
<input type="checkbox"/>	20	GE20	Trunk	1	All	Enabled	Disabled	0x8100
<input type="checkbox"/>	21	GE21	Trunk	1	All	Enabled	Disabled	0x8100
<input type="checkbox"/>	22	GE22	Trunk	1	All	Enabled	Disabled	0x8100
<input type="checkbox"/>	23	GE23	Trunk	1	All	Enabled	Disabled	0x8100
<input type="checkbox"/>	24	GE24	Trunk	1	All	Enabled	Disabled	0x8100
<input type="checkbox"/>	25	GE25	Trunk	1	All	Enabled	Disabled	0x8100
<input type="checkbox"/>	26	GE26	Trunk	1	All	Enabled	Disabled	0x8100
<input type="checkbox"/>	27	GE27	Trunk	1	All	Enabled	Disabled	0x8100
<input type="checkbox"/>	28	GE28	Trunk	1	All	Enabled	Disabled	0x8100
<input type="checkbox"/>	29	GE29	Trunk	1	All	Enabled	Disabled	0x8100
<input type="checkbox"/>	30	GE30	Trunk	1	All	Enabled	Disabled	0x8100
<input type="checkbox"/>	31	GE31	Trunk	1	All	Enabled	Disabled	0x8100
<input type="checkbox"/>	32	GE32	Trunk	1	All	Enabled	Disabled	0x8100
<input type="checkbox"/>	33	GE33	Trunk	1	All	Enabled	Disabled	0x8100
<input type="checkbox"/>	34	GE34	Trunk	1	All	Enabled	Disabled	0x8100
<input type="checkbox"/>	35	GE35	Trunk	1	All	Enabled	Disabled	0x8100
<input type="checkbox"/>	36	GE36	Trunk	1	All	Enabled	Disabled	0x8100
<input type="checkbox"/>	37	GE37	Trunk	1	All	Enabled	Disabled	0x8100
<input type="checkbox"/>	38	GE38	Trunk	1	All	Enabled	Disabled	0x8100
<input type="checkbox"/>	39	GE39	Trunk	1	All	Enabled	Disabled	0x8100
<input type="checkbox"/>	40	GE40	Trunk	1	All	Enabled	Disabled	0x8100
<input type="checkbox"/>	41	GE41	Trunk	1	All	Enabled	Disabled	0x8100
<input type="checkbox"/>	42	GE42	Trunk	1	All	Enabled	Disabled	0x8100
<input type="checkbox"/>	43	GE43	Trunk	1	All	Enabled	Disabled	0x8100
<input type="checkbox"/>	44	GE44	Trunk	1	All	Enabled	Disabled	0x8100
<input type="checkbox"/>	45	GE45	Trunk	1	All	Enabled	Disabled	0x8100
<input type="checkbox"/>	46	GE46	Trunk	1	All	Enabled	Disabled	0x8100
<input type="checkbox"/>	47	GE47	Trunk	1	All	Enabled	Disabled	0x8100
<input type="checkbox"/>	48	GE48	Trunk	1	All	Enabled	Disabled	0x8100
<input type="checkbox"/>	49	10GE1	Trunk	1	All	Enabled	Disabled	0x8100
<input type="checkbox"/>	50	10GE2	Trunk	1	All	Enabled	Disabled	0x8100
<input type="checkbox"/>	51	10GE3	Trunk	1	All	Enabled	Disabled	0x8100
<input type="checkbox"/>	52	10GE4	Trunk	1	All	Enabled	Disabled	0x8100
<input type="checkbox"/>	53	10GE5	Trunk	1	All	Enabled	Disabled	0x8100
<input type="checkbox"/>	54	10GE6	Trunk	1	All	Enabled	Disabled	0x8100
<input type="checkbox"/>	55	LAG1	Trunk	1	All	Enabled	Disabled	0x8100
<input type="checkbox"/>	56	LAG2	Trunk	1	All	Enabled	Disabled	0x8100
<input type="checkbox"/>	57	LAG3	Trunk	1	All	Enabled	Disabled	0x8100
<input type="checkbox"/>	58	LAG4	Trunk	1	All	Enabled	Disabled	0x8100
<input type="checkbox"/>	59	LAG5	Trunk	1	All	Enabled	Disabled	0x8100
<input type="checkbox"/>	60	LAG6	Trunk	1	All	Enabled	Disabled	0x8100
<input type="checkbox"/>	61	LAG7	Trunk	1	All	Enabled	Disabled	0x8100
<input type="checkbox"/>	62	LAG8	Trunk	1	All	Enabled	Disabled	0x8100

Item	Description
Port	Display the interface.
Mode	Display the VLAN mode of interface.
PVID	Display the Port-based VLAN ID of port.
Accept Frame Type	Display accept frame type of port.
Ingress Filtering	Display ingress filter status of port.
Uplink	Display uplink status.
TPID	Display TPID used of interface.

Click **“Edit”** button to Edit Port Setting menu.

Edit Port Setting

Port	GE1
Mode	<input type="radio"/> Hybrid <input type="radio"/> Access <input checked="" type="radio"/> Trunk <input type="radio"/> Tunnel
PVID	<input type="text" value="1"/> (1 - 4094)
Accept Frame Type	<input checked="" type="radio"/> All <input type="radio"/> Tag Only <input type="radio"/> Untag Only
Ingress Filtering	<input checked="" type="checkbox"/> Enable
Uplink	<input type="checkbox"/> Enable
TPID	<input type="text" value="0x8100"/>

Item	Description
Port	Display selected port to be edited.
Mode	Select the VLAN mode of the interface. <ul style="list-style-type: none"> ● Forbidden: Set VLAN as forbidden VLAN. ● Hybrid: Support all functions as defined in IEEE 802.1Q specification. ● Access: Accepts only untagged frames and join an untagged VLAN. ● Trunk: An untagged member of one VLAN at most, and is a tagged member of zero or more VLANs.
PVID	Specify the port-based VLAN ID (1-4094). It's only available with Hybrid and Trunk mode.
Accepted Type	Specify the acceptable-frame-type of the specified interfaces. It's only available with Hybrid mode.
Ingress Filtering	Set checkbox to enable/disable ingress filtering. It's only available with Hybrid mode.
Uplink	Set checkbox to enable/disable uplink mode. It's only available with trunk mode.
TPID	Select TPID used of interface. It's only available with trunk mode.

IV-5-2. Voice VLAN

Use the Voice VLAN pages to configure settings of Voice VLAN.

IV-5-2-1. Property

This page allow user to configure global and per interface settings of voice VLAN.

To display Property Web page, click **VLAN> Voice VLAN> Property**.

Port Setting Table

Entry	Port	State	Mode	QoS Policy	
<input type="checkbox"/>	1	GE1	Disabled	Auto	Voice Packet
<input type="checkbox"/>	2	GE2	Disabled	Auto	Voice Packet
<input type="checkbox"/>	3	GE3	Disabled	Auto	Voice Packet
<input type="checkbox"/>	4	GE4	Disabled	Auto	Voice Packet
<input type="checkbox"/>	5	GE5	Disabled	Auto	Voice Packet
<input type="checkbox"/>	6	GE6	Disabled	Auto	Voice Packet
<input type="checkbox"/>	7	GE7	Disabled	Auto	Voice Packet
<input type="checkbox"/>	8	GE8	Disabled	Auto	Voice Packet
<input type="checkbox"/>	9	GE9	Disabled	Auto	Voice Packet
<input type="checkbox"/>	10	GE10	Disabled	Auto	Voice Packet
<input type="checkbox"/>	11	GE11	Disabled	Auto	Voice Packet
<input type="checkbox"/>	12	GE12	Disabled	Auto	Voice Packet
<input type="checkbox"/>	13	GE13	Disabled	Auto	Voice Packet
<input type="checkbox"/>	14	GE14	Disabled	Auto	Voice Packet
<input type="checkbox"/>	15	GE15	Disabled	Auto	Voice Packet
<input type="checkbox"/>	16	GE16	Disabled	Auto	Voice Packet
<input type="checkbox"/>	17	GE17	Disabled	Auto	Voice Packet
<input type="checkbox"/>	18	GE18	Disabled	Auto	Voice Packet
<input type="checkbox"/>	19	LAG1	Disabled	Auto	Voice Packet

Item	Description
State	Set checkbox to enable or disable voice VLAN function.
VLAN	Select Voice VLAN ID. Voice VLAN ID cannot be default VLAN.
Cos/802.1p	Select a value of VPT. Qualified packets will use this VPT value as inner priority.
Remarkings	Set checkbox to enable or disable 1p remarking. If enabled, qualified packets will be remark by this value.
Aging Time	Input value of aging time. Default is 1440 minutes. A voice VLAN entry will be age out after this time if without any packet pass through.
Port Setting Table	
Port	Display port entry.
State	Display enable/disabled status of interface.
Mode	Display voice VLAN mode.
QoS Policy	Display voice VLAN remark will effect which kind of packet.

Click **“Edit”** button to view Edit Port Setting menu.

Edit Port Setting

Port	GE1
State	<input type="checkbox"/> Enable
Mode	<input checked="" type="radio"/> Auto <input type="radio"/> Manual
QoS Policy	<input checked="" type="radio"/> Voice Packet <input type="radio"/> All

Item	Description
Port	Display selected port to be edited.
State	Set checkbox to enable/disabled voice VLAN function of interface.
Mode	Select port voice VLAN mode <ul style="list-style-type: none">● Auto: Voice VLAN auto detect packets that match OUI table and add received port into voice VLAN ID tagged member.● Manual: User need add interface to VLAN ID tagged member manually.
QoS Policy	Select port QoS Policy mode <ul style="list-style-type: none">● Voice Packet: QoS attributes are applied to packets with OUIs in the source MAC address.● All: QoS attributes are applied to packets that are classified to Voice VLAN.

IV-5-2-2. Voice OUI

This page allow user to add, edit or delete OUI MAC addresses. Default has 8 pre-defined OUI MAC.

To display the Voice OUI Web page, click **VLAN > Voice VLAN > Voice OUI**.

Voice OUI Table

Showing All entries

Showing 1 to 8 of 8 entries

<input type="checkbox"/>	OUI	Description
<input type="checkbox"/>	00:E0:BB	3COM
<input type="checkbox"/>	00:03:6B	Cisco
<input type="checkbox"/>	00:E0:75	Veritel
<input type="checkbox"/>	00:D0:1E	Pingtel
<input type="checkbox"/>	00:01:E3	Siemens
<input type="checkbox"/>	00:60:B9	NEC/Philips
<input type="checkbox"/>	00:0F:E2	H3C
<input type="checkbox"/>	00:09:6E	Avaya

Add

Edit

Delete

First

Previous

1

Next

Last

Item	Description
OUI	Display OUI MAC address.
Description	Display description of OUI entry.

Click “Add” or “Edit” button to Add/Edit Voice OUI menu.

Add Voice OUI

OUI	<input type="text"/> : <input type="text"/> : <input type="text"/>
Description	<input type="text"/>

Apply

Close

Edit Voice OUI

OUI	00:03:6B
Description	Cisco

Apply

Close

Item	Description
OUI	Input OUI MAC address. Can't be edited in edit dialog.
Description	Input description of the specified MAC address to the voice VLAN OUI table.

IV-5-3. Protocol VLAN

Use the Protocol VLAN pages to configure settings of Protocol VLAN.

IV-5-3-1. Protocol Group

This page allow user to add or edit groups settings of Protocol VLAN.

To display the Protocol page, click **VLAN > Protocol VLAN > Protocol Group**.

Protocol Group Table

Showing All entries Showing 0 to 0 of 0 entries

Group ID	Frame Type	Protocol Value
0 results found.		

Add Edit Delete

First Previous 1 Next Last

Item	Description
Group ID	Display group ID of entry.
Frame Type	This function maps packets to protocol-defined VLAN by examining the type octet within the packet header to discover the type of protocol associated with it.
Protocol Value	Display the Ether type of the target protocol.

Click **"Add"** button or **"Edit"** button to view Add/Edit MAC menu.

Add Protocol Group

Group ID 1

Frame Type Ethernet_II

Protocol Value 0x (0x600 ~ 0xFFFFE)

Apply Close

Item	Description
Group ID	Input group ID that is a unique ID of group entry. The range from 1 to8. Only available on Add Dialog.
Frame Type	Select a frame type (Ethernet_II, IEEE802.3_LL_C_Other, RFC_1042) for Group ID. - Ethernet_II: Packet type is Ethernet version 2. - IEEE802.3_LL_C_Other: packet type is 802.3 packet with LLC other header. - RFC_1042: This RFC specifies a standard method of encapsulating the Internet Protocol (IP) datagrams and Address Resolution Protocol (ARP) requests and replies on IEEE 802 Networks to allow compatible and interoperable implementations. This RFC specifies a protocol standard for the Internet community.
Protocol Value	Input the Ether type of the target protocol.

IV-5-3-2. Group Binding

This page allow user to bind VLAN group to each port with Group ID.

To display Group Binding page, click **VLAN> Protocol VLAN > Group Binding**.

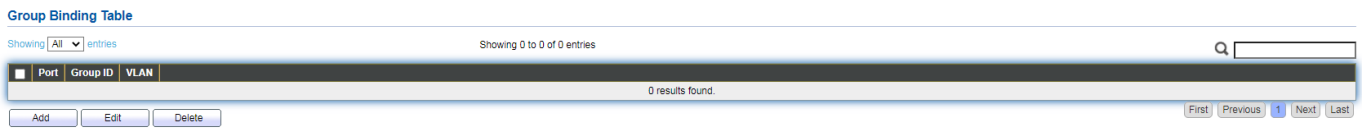

Item	Description
Port	Display port ID that binding with group entry.
Group ID	Display group ID that port binding with.
VLAN	Display VLAN ID that assign to packets which match group.

Click **“Add”** or **“Edit”** button to view the Add/Edit Group Binding menu.

Add Group Binding

Available Port Selected Port

Port

Note: Only VLAN Hybrid port can be set Protocol VLAN

Group ID None

VLAN (1 - 4094)

Apply Close

Item	Description
Port	Select ports in left box then move to right to binding with group. Or select ports in right box then move to left to unbind with group. Only interface has hybrid VLAN mode can be selected and bound with protocol group. Only available on Add dialog.
Group ID	Select a Group ID to associate with port. Only available on Add dialog.
VLAN	Input VLAN ID that will assign to packets which match group.

IV-5-4. MAC VLAN

Use the MAC VLAN pages to configure settings of MAC VLAN.

IV-5-4-1. MAC Group

This page allow user to add or edit groups settings of MAC VLAN.

To display the MAC page, click **VLAN > MAC VLAN > MAC Group**.

MAC Group Table

Showing All entries

Showing 0 to 0 of 0 entries

Group ID	MAC Address	Mask
0 results found.		
<input type="button" value="Add"/>	<input type="button" value="Edit"/>	<input type="button" value="Delete"/>
<input type="button" value="First"/>	<input type="button" value="Previous"/>	<input type="button" value="1"/>
<input type="button" value="Next"/>	<input type="button" value="Last"/>	

Item	Description
Group ID	Display group ID of entry.
MAC Address	Display mac address of entry.
Mask	Display mask of mac address for classified packet.

Click **"Add"** button or **"Edit"** button to view Add/Edit MAC menu.

Add MAC Group

Group ID	<input style="width: 80%;" type="text" value="(1 - 2147483647)"/>
MAC Address	<input style="width: 80%;" type="text"/>
Mask	<input style="width: 80%;" type="text" value="(9 - 48)"/>

Edit MAC Group

Group ID	undefined
MAC Address	<input style="width: 80%;" type="text"/>
Mask	<input style="width: 80%;" type="text" value="(9 - 48)"/>

Item	Description
Group ID	Input group ID that is a unique ID of mac group entry. The range from 1 to 2147483647. Only available on Add Dialog.
MAC Address	Input mac address for classifying packets.
Mask	Input mask of mac address.

Edit Group Binding

Port	
Group ID	
VLAN	<input type="text" value=""/> (1 - 4094)

Item	Description
Port	Select ports in left box then move to right to binding with MAC group. Or select ports in right box then move to left to unbind with MAC group. Only interface has hybrid VLAN mode can be selected and bound with protocol group. Only available on Add dialog.
Group ID	Select a Group ID to associate with port. Only available on Add dialog.
VLAN	Input VLAN ID that will assign to packets which match MAC group.

IV-5-5. Surveillance VLAN

Use the Surveillance VLAN pages to configure settings of Surveillance VLAN.

IV-5-5-1. Property

State	<input type="checkbox"/> Enable
VLAN	<input type="text" value="None"/> ▼
CoS / 802.1p Remarking	<input type="checkbox"/> Enable <input type="text" value="6"/> ▼
Port Aging Time	<input type="text" value="1440"/> Min (30 - 65536, default 1440) Note: Aging Time = Port Aging Time + OUI Aging Time(30 mins)

Entry	Port	State	Mode	QoS Policy	
<input type="checkbox"/>	1	GE1	Disabled	Auto	Video Packet
<input type="checkbox"/>	2	GE2	Disabled	Auto	Video Packet
<input type="checkbox"/>	3	GE3	Disabled	Auto	Video Packet
<input type="checkbox"/>	4	GE4	Disabled	Auto	Video Packet
<input type="checkbox"/>	5	GE5	Disabled	Auto	Video Packet
<input type="checkbox"/>	6	GE6	Disabled	Auto	Video Packet
<input type="checkbox"/>	7	GE7	Disabled	Auto	Video Packet
<input type="checkbox"/>	8	GE8	Disabled	Auto	Video Packet
<input type="checkbox"/>	9	GE9	Disabled	Auto	Video Packet
<input type="checkbox"/>	10	GE10	Disabled	Auto	Video Packet
<input type="checkbox"/>	11	GE11	Disabled	Auto	Video Packet
<input type="checkbox"/>	12	GE12	Disabled	Auto	Video Packet
<input type="checkbox"/>	13	GE13	Disabled	Auto	Video Packet
<input type="checkbox"/>	14	GE14	Disabled	Auto	Video Packet
<input type="checkbox"/>	15	GE15	Disabled	Auto	Video Packet
<input type="checkbox"/>	16	GE16	Disabled	Auto	Video Packet
<input type="checkbox"/>	17	GE17	Disabled	Auto	Video Packet
<input type="checkbox"/>	18	GE18	Disabled	Auto	Video Packet
<input type="checkbox"/>	19	GE19	Disabled	Auto	Video Packet
<input type="checkbox"/>	20	GE20	Disabled	Auto	Video Packet
<input type="checkbox"/>	21	GE21	Disabled	Auto	Video Packet
<input type="checkbox"/>	22	GE22	Disabled	Auto	Video Packet
<input type="checkbox"/>	23	GE23	Disabled	Auto	Video Packet
<input type="checkbox"/>	24	GE24	Disabled	Auto	Video Packet
<input type="checkbox"/>	25	GE25	Disabled	Auto	Video Packet
<input type="checkbox"/>	26	GE26	Disabled	Auto	Video Packet
<input type="checkbox"/>	27	GE27	Disabled	Auto	Video Packet
<input type="checkbox"/>	28	GE28	Disabled	Auto	Video Packet
<input type="checkbox"/>	29	GE29	Disabled	Auto	Video Packet
<input type="checkbox"/>	31	GE31	Disabled	Auto	Video Packet
<input type="checkbox"/>	32	GE32	Disabled	Auto	Video Packet
<input type="checkbox"/>	33	GE33	Disabled	Auto	Video Packet
<input type="checkbox"/>	34	GE34	Disabled	Auto	Video Packet
<input type="checkbox"/>	35	GE35	Disabled	Auto	Video Packet
<input type="checkbox"/>	36	GE36	Disabled	Auto	Video Packet
<input type="checkbox"/>	37	GE37	Disabled	Auto	Video Packet
<input type="checkbox"/>	38	GE38	Disabled	Auto	Video Packet
<input type="checkbox"/>	39	GE39	Disabled	Auto	Video Packet
<input type="checkbox"/>	40	GE40	Disabled	Auto	Video Packet
<input type="checkbox"/>	41	GE41	Disabled	Auto	Video Packet
<input type="checkbox"/>	42	GE42	Disabled	Auto	Video Packet
<input type="checkbox"/>	43	GE43	Disabled	Auto	Video Packet
<input type="checkbox"/>	44	GE44	Disabled	Auto	Video Packet
<input type="checkbox"/>	45	GE45	Disabled	Auto	Video Packet
<input type="checkbox"/>	46	GE46	Disabled	Auto	Video Packet
<input type="checkbox"/>	47	GE47	Disabled	Auto	Video Packet
<input type="checkbox"/>	48	GE48	Disabled	Auto	Video Packet
<input type="checkbox"/>	49	10GE1	Disabled	Auto	Video Packet
<input type="checkbox"/>	50	10GE2	Disabled	Auto	Video Packet
<input type="checkbox"/>	51	10GE3	Disabled	Auto	Video Packet
<input type="checkbox"/>	52	10GE4	Disabled	Auto	Video Packet
<input type="checkbox"/>	53	10GE5	Disabled	Auto	Video Packet
<input type="checkbox"/>	54	10GE6	Disabled	Auto	Video Packet
<input type="checkbox"/>	55	LAG1	Disabled	Auto	Video Packet
<input type="checkbox"/>	56	LAG2	Disabled	Auto	Video Packet
<input type="checkbox"/>	57	LAG3	Disabled	Auto	Video Packet
<input type="checkbox"/>	58	LAG4	Disabled	Auto	Video Packet
<input type="checkbox"/>	59	LAG5	Disabled	Auto	Video Packet
<input type="checkbox"/>	60	LAG6	Disabled	Auto	Video Packet
<input type="checkbox"/>	61	LAG7	Disabled	Auto	Video Packet
<input type="checkbox"/>	62	LAG8	Disabled	Auto	Video Packet

[Edit](#)

Item	Description
State	Enable/Disable
VLAN	Choose none or indicate VLAN
CoS/802.1P Remarking	The 802.1p standard defines seven levels of CoS from 0 through to 7 (highest priority). 802.1p is a sub-set of the 802.1q standard which added additional fields into the header of a standard Ethernet frame allowing it to contain VLAN identifiers as well as the priority values.
Port Aging Time	When aging is configured on an interface that's using port security, all the dynamically learned secure addresses age out when the aging time expire

To display Port Setting page, click the “Edit” button.

Edit Port Setting

Port	GE1
State	<input type="checkbox"/> Enable
Mode	<input checked="" type="radio"/> Auto <input type="radio"/> Manual
QoS Policy	<input checked="" type="radio"/> Video Packet <input type="radio"/> All

Item	Description
Port	Display port entry.
State	Display enable/disabled status of interface.
Mode	Display voice VLAN mode.
QoS Policy	Display voice VLAN remark will effect which kind of packet.

IV-5-5-2. Surveillance OUI

Surveillance OUI Table

Showing All entries Showing 1 to 2 of 2 entries

Description	OUI	OUI Mask
<input type="checkbox"/> DAhua	74:DA:38:00:00:00	FF-FF-FF-00-00-00
<input type="checkbox"/> DH IP cam	50:DE:19:00:00:00	FF-FF-FF-00-00-00

Item	Description
OUI	An organizationally unique identifier (OUI) is a 24-bit number that uniquely identifies a vendor, manufacturer, or other organization. ... In MAC addresses, the OUI is combined with a 24-bit number (assigned by the assignee of the OUI) to form the address.
OUI Mask	Specifies a set of MAC addresses using a bit mask to indicate the bits of the MAC addresses that must fit to the specified MAC address attribute.

To change the description of your IP camera, click the “Edit” button.

Edit Surveillance OUI

OUI	74:DA:38:00:00:00
Description	DAhua <input type="text"/>

Apply

Close

IV-6. MAC Address Table

Use the MAC Address Table pages to show dynamic MAC table and configure settings for static MAC entries.

IV-6-1. Dynamic Address

To display the Dynamic Address web page, click **MAC Address Table > Dynamic Address**.

Aging Time	<input type="text" value="300"/>	Sec (10 - 630, default 300)
------------	----------------------------------	-----------------------------

Apply

Dynamic Address Table

Showing All entries

Showing 1 to 1 of 1 entries



	VLAN	MAC Address	Port
<input type="checkbox"/>	1	B8:6B:23:6D:C1:14	GE28

First Previous 1 Next Last

Clear

Refresh

Add Static Address

Item	Description
Aging Time	The time in seconds that an entry remains in the MAC address table. Its valid range is from 10 to 630 seconds, and the default value is 300 seconds.

IV-6-2. Static Address

To display the Static Address web page, click **MAC Address Table > Static Address**.

Static Address Table

Showing All entries Showing 0 to 0 of 0 entries

<input type="checkbox"/>	VLAN	MAC Address	Port
0 results found.			

Item	Description
MAC Address	The MAC address to which packets will be statically forwarded.
VLAN	Specify the VLAN to show or clear MAC entries.
Port	Interface or port number.

IV-6-3. Filtering Address

To display the Filtering Address web page, click **MAC Address Table > Filtering Address**.

Filtering Address Table

Showing All entries Showing 0 to 0 of 0 entries

<input type="checkbox"/>	VLAN	MAC Address
0 results found.		

Item	Description
MAC Address	Specify unicast MAC address in the packets to be dropped.
VLAN	Specify the VLAN to show or clear MAC entries.

IV-7. Spanning Tree

The Spanning Tree Protocol (STP) is a network protocol that ensures a loop-free topology for any bridged Ethernet local area network.

IV-7-1. Property

To display the Property web page, click **Spanning Tree > Property**.

State	<input type="checkbox"/> Enable
Operation Mode	<input type="radio"/> STP <input checked="" type="radio"/> RSTP <input type="radio"/> MSTP
Path Cost	<input checked="" type="radio"/> Long <input type="radio"/> Short
BPDU Handling	<input type="radio"/> Filtering <input checked="" type="radio"/> Flooding
Priority	<input type="text" value="32768"/> (0 - 61440, default 32768)
Hello Time	<input type="text" value="2"/> Sec (1 - 10, default 2)
Max Age	<input type="text" value="20"/> Sec (6 - 40, default 20)
Forward Delay	<input type="text" value="15"/> Sec (4 - 30, default 15)
Tx Hold Count	<input type="text" value="6"/> (1 - 10, default 6)
Region Name	<input type="text" value="74:DA:38:17:6E:7A"/>
Revision	<input type="text" value="0"/> (0 - 65535, default 0)
Max Hop	<input type="text" value="20"/> (1 - 40, default 20)
Operational Status	
Bridge Identifier	32768-74:DA:38:17:6E:7A
Designated Root Bridge	0-00:00:00:00:00:00
Root Port	N/A
Root Path Cost	0
Topology Change Count	0
Last Topology Change	0D/0H/0M/0S

Item	Description
State	Enable/disable the STP on the switch.
Operation Mode	Specify the STP operation mode. <ul style="list-style-type: none"> ● STP: Enable the Spanning Tree (STP) operation.

	<ul style="list-style-type: none"> ● RSTP: Enable the Rapid Spanning Tree (RSTP) operation. ● MSTP: Enable the Multiple Spanning Tree (MSTP) operation.
Path Cost	<p>Specify the path cost method.</p> <ul style="list-style-type: none"> ● Long: Specifies that the default port path costs are within the range: 1-200,000,000. ● Short: Specifies that the default port path costs are within the range: 1-65,535.
BPDU Handling	<p>Specify the BPDU forward method when the STP is disabled.</p> <ul style="list-style-type: none"> ● Filtering: Filter the BPDU when STP is disabled. ● Flooding: Flood the BPDU when STP is disabled.
Priority	<p>Specify the bridge priority. The valid range is from 0 to 61440, and the value should be the multiple of 4096. It ensures the probability that the switch is selected as the root bridge, and the lower value has the higher priority for the switch to be selected as the root bridge of the topology.</p>
Hello Time	<p>Specify the STP hello time in second to broadcast its hello message to other bridges by Designated Ports. Its valid range is from 1 to 10 seconds.</p>
Max Age	<p>Specify the time interval in seconds for a switch to wait the configuration messages, without attempting to redefine its own configuration.</p>
Forward Delay	<p>Specify the STP forward delay time, which is the amount of time that a port remains in the Listening and Learning states before it enters the Forwarding state. Its valid range is from 4 to 10 seconds.</p>
TX Hold Count	<p>Specify the tx-hold-count used to limit the maximum numbers of packets transmission per second. The valid range is from 1 to 10.</p>
Region Name	<p>The MSTP instance name. Its maximum length is 32 characters. The default value is the MAC address of the switch.</p>
Revision	<p>The MSTP revision number. Its valid range is from 0 to 65535.</p>
Max Hop	<p>Specify the number of hops in an MSTP region before the BPDU is discarded. The valid range is 1 to 40.</p>
Operational Status	
Bridge Identifier	<p>Bridge identifier of the switch.</p>
Designated Root Identifier	<p>Bridge identifier of the designated root bridge.</p>
Root Port	<p>Operational root port of the switch.</p>
Root Path Cost	<p>Operational root path cost.</p>
Topology Change	<p>Numbers of the topology changes.</p>

Count	
Last Topology Change	The last time for the topology change.

IV-7-2. Port Setting

To configure and display the STP port settings, click **STP > Port Setting**.

Port Setting Table

Entry	Port	State	Path Cost	Priority	BPDU Filter	BPDU Guard	Operational Edge	Operational Point-to-Point	Port Role	Port State	Designated Bridge	Designated Port ID	Designated Cost	
<input type="checkbox"/>	1	GE1	Enabled	20000	128	Disabled	Disabled	Disabled	Enabled	Root	Forwarding	32768-2C:FA:A2:5C:2D:62	128-1	20000
<input type="checkbox"/>	2	GE2	Enabled	200000	128	Disabled	Disabled	Disabled	Enabled	Designated	Forwarding	32768-FC:8F:C4:0D:1A:B5	128-2	200000
<input type="checkbox"/>	3	GE3	Enabled	20000	128	Disabled	Disabled	Disabled	Disabled	Disabled	Disabled	0-00:00:00:00:00:00	128-3	20000
<input type="checkbox"/>	4	GE4	Enabled	20000	128	Disabled	Disabled	Disabled	Disabled	Disabled	Disabled	0-00:00:00:00:00:00	128-4	20000
<input type="checkbox"/>	5	GE5	Enabled	20000	128	Disabled	Disabled	Disabled	Disabled	Disabled	Disabled	0-00:00:00:00:00:00	128-5	20000
<input type="checkbox"/>	6	GE6	Enabled	20000	128	Disabled	Disabled	Disabled	Disabled	Disabled	Disabled	0-00:00:00:00:00:00	128-6	20000
<input type="checkbox"/>	7	GE7	Enabled	20000	128	Disabled	Disabled	Disabled	Disabled	Disabled	Disabled	0-00:00:00:00:00:00	128-7	20000
<input type="checkbox"/>	8	GE8	Enabled	20000	128	Disabled	Disabled	Disabled	Disabled	Disabled	Disabled	0-00:00:00:00:00:00	128-8	20000
<input type="checkbox"/>	9	GE9	Enabled	20000	128	Disabled	Disabled	Disabled	Disabled	Disabled	Disabled	0-00:00:00:00:00:00	128-9	20000
<input type="checkbox"/>	10	GE10	Enabled	20000	128	Disabled	Disabled	Disabled	Disabled	Disabled	Disabled	0-00:00:00:00:00:00	128-10	20000
<input type="checkbox"/>	11	GE11	Enabled	20000	128	Disabled	Disabled	Disabled	Disabled	Disabled	Disabled	0-00:00:00:00:00:00	128-11	20000
<input type="checkbox"/>	12	GE12	Enabled	20000	128	Disabled	Disabled	Disabled	Disabled	Disabled	Disabled	0-00:00:00:00:00:00	128-12	20000
<input type="checkbox"/>	13	GE13	Enabled	20000	128	Disabled	Disabled	Disabled	Disabled	Disabled	Disabled	0-00:00:00:00:00:00	128-13	20000
<input type="checkbox"/>	14	GE14	Enabled	20000	128	Disabled	Disabled	Disabled	Disabled	Disabled	Disabled	0-00:00:00:00:00:00	128-14	20000
<input type="checkbox"/>	15	GE15	Enabled	20000	128	Disabled	Disabled	Disabled	Disabled	Disabled	Disabled	0-00:00:00:00:00:00	128-15	20000
<input type="checkbox"/>	16	GE16	Enabled	200000	128	Disabled	Disabled	Disabled	Enabled	Designated	Forwarding	32768-FC:8F:C4:0D:1A:B5	128-16	200000
<input type="checkbox"/>	17	GE17	Enabled	20000	128	Disabled	Disabled	Disabled	Disabled	Disabled	Disabled	0-00:00:00:00:00:00	128-17	20000
<input type="checkbox"/>	18	GE18	Enabled	20000	128	Disabled	Disabled	Disabled	Disabled	Disabled	Disabled	0-00:00:00:00:00:00	128-18	20000
<input type="checkbox"/>	19	GE19	Enabled	20000	128	Disabled	Disabled	Disabled	Disabled	Disabled	Disabled	0-00:00:00:00:00:00	128-19	20000
<input type="checkbox"/>	20	GE20	Enabled	20000	128	Disabled	Disabled	Disabled	Disabled	Disabled	Disabled	0-00:00:00:00:00:00	128-20	20000
<input type="checkbox"/>	21	GE21	Enabled	20000	128	Disabled	Disabled	Disabled	Disabled	Disabled	Disabled	0-00:00:00:00:00:00	128-21	20000
<input type="checkbox"/>	22	GE22	Enabled	20000	128	Disabled	Disabled	Disabled	Disabled	Disabled	Disabled	0-00:00:00:00:00:00	128-22	20000

Item	Description
Port	Specify the interface ID or the list of interface IDs.
State	The operational state on the specified port.
Path Cost	STP path cost on the specified port.
Priority	STP priority on the specified port.
BPDU Filter	The states of BPDU filter on the specified port.
BPDU Guard	The states of BPDU guard on the specified port.
Operational Edge	The operational edge port status on the specified port.
Operational Point-to-Point	The operational point-to-point status on the specified port.
Port Role	The current port role on the specified port. The possible values are: "Disabled", "Master", "Root", "Designated", "Alternative", and "Backup".
Port State	The current port state on the specified port. The possible values are: "Disabled", "Discarding", "Learning", and "Forwarding".
Designated	The bridge ID of the designated bridge.

Bridge	
Designated Port ID	The designated port ID on the switch.
Designated Cost	The path cost of the designated port on the switch.
Protocol Migration Check	Restart the Spanning Tree Protocol (STP) migration process (re-negotiate with its neighborhood) on the specific interface.

Click "**Edit**" button to view Edit Port Setting menu.

Edit Port Setting

Port	GE1
State	<input checked="" type="checkbox"/> Enable
Path Cost	<input type="text" value="0"/> (0 - 200000000) (0 = Auto)
Priority	128 ▼
Edge Port	<input type="checkbox"/> Enable
BPDU Filter	<input type="checkbox"/> Enable
BPDU Guard	<input type="checkbox"/> Enable
Point-to-Point	<input checked="" type="radio"/> Auto <input type="radio"/> Enable <input type="radio"/> Disable
Port State	Disabled
Designated Bridge	0-00:00:00:00:00:00
Designated Port ID	128-1
Designated Cost	20000
Operational Edge	False
Operational Point-to-Point	False

Apply Close

Item	Description
Port	Selected port ID.
State	Enable/Disable the STP on the specified port.

Path Cost	Specify the STP path cost on the specified port.
Priority	Specify the STP path cost on the specified port.
Edge Port	<p>Specify the edge mode.</p> <ul style="list-style-type: none"> ● Enable: Force to true state (as link to a host). ● Disable: Force to false state (as link to a bridge). <p>In the edge mode, the interface would be put into the Forwarding state immediately upon link up. If the edge mode is enabled for the interface and there are BPDUs received on the interface, the loop might be occurred in the short time before the STP state change.</p>
BPDU Filter	<p>The BPDU Filter configuration avoids receiving / transmitting BPDU from the specified ports.</p> <ul style="list-style-type: none"> ● Enable: Enable BPDU filter function. ● Disable: Disable BPDU filter function.
BPDU Guard	<p>The BPDU Guard configuration to drop the received BPDU directly.</p> <ul style="list-style-type: none"> ● Enable: Enable BPDU guard function. ● Disable: Disable BPDU guard function.
Point-to-Point	<p>Specify the Point-to-Point port configuration:</p> <ul style="list-style-type: none"> ● Auto: The state is depended on the duplex setting of the port ● Enable: Force to true state. ● Disable: Force to false state

IV-7-3. MST Instance

To configure MST instance setting, click **STP > MST Instance**.

MST Instance Table

	MSTI	Priority	Bridge Identifier	Designated Root Bridge	Root Port	Root Path Cost	Remaining Hop	VLAN
<input type="radio"/>	0	32768	32768-74:DA:38:17:6E:7A	0-00:00:00:00:00:00	N/A	0	0	1-4094
<input type="radio"/>	1	32768	32768-74:DA:38:17:6E:7A	0-00:00:00:00:00:00	N/A	0	0	
<input type="radio"/>	2	32768	32768-74:DA:38:17:6E:7A	0-00:00:00:00:00:00	N/A	0	0	
<input type="radio"/>	3	32768	32768-74:DA:38:17:6E:7A	0-00:00:00:00:00:00	N/A	0	0	
<input type="radio"/>	4	32768	32768-74:DA:38:17:6E:7A	0-00:00:00:00:00:00	N/A	0	0	
<input type="radio"/>	5	32768	32768-74:DA:38:17:6E:7A	0-00:00:00:00:00:00	N/A	0	0	
<input type="radio"/>	6	32768	32768-74:DA:38:17:6E:7A	0-00:00:00:00:00:00	N/A	0	0	
<input type="radio"/>	7	32768	32768-74:DA:38:17:6E:7A	0-00:00:00:00:00:00	N/A	0	0	
<input type="radio"/>	8	32768	32768-74:DA:38:17:6E:7A	0-00:00:00:00:00:00	N/A	0	0	
<input type="radio"/>	9	32768	32768-74:DA:38:17:6E:7A	0-00:00:00:00:00:00	N/A	0	0	
<input type="radio"/>	10	32768	32768-74:DA:38:17:6E:7A	0-00:00:00:00:00:00	N/A	0	0	
<input type="radio"/>	11	32768	32768-74:DA:38:17:6E:7A	0-00:00:00:00:00:00	N/A	0	0	
<input type="radio"/>	12	32768	32768-74:DA:38:17:6E:7A	0-00:00:00:00:00:00	N/A	0	0	
<input type="radio"/>	13	32768	32768-74:DA:38:17:6E:7A	0-00:00:00:00:00:00	N/A	0	0	
<input type="radio"/>	14	32768	32768-74:DA:38:17:6E:7A	0-00:00:00:00:00:00	N/A	0	0	
<input type="radio"/>	15	32768	32768-74:DA:38:17:6E:7A	0-00:00:00:00:00:00	N/A	0	0	

[Edit](#)

Item	Description
MSTI	Designated port number.
Priority	The bridge priority on the specified MSTI.
Bridge Identifier	The bridge identifier on the specified MSTI.
Designated Root Bridge	The designated root bridge identifier on the specified MSTI.
Root Port	The designated root port on the specified MSTI.
Root Path Cost	The designated root path cost on the specified MSTI.
Remaining Hop	The configuration of remaining hop on the specified MSTI.
VLAN	The VLAN configuration on the specified MSTI.

Click "**Edit**" button to view Edit MST Instance menu.

Edit MST Instance Setting

MSTI	1	
VLAN	Available VLAN	Selected VLAN
	<ul style="list-style-type: none"> 1 2 3 4 5 6 7 8 	
Priority	<input type="text" value="32768"/> (0 - 61440, default 32768)	
Bridge Identifier	32768-74:DA:38:17:6E:7A	
Designated Root Bridge	0-00:00:00:00:00:00	
Root Port		
Root Path Cost	0	
Remaining Hop	0	

Item	Description
VLAN	Select the VLAN list for the specified MSTI.
Priority	Specify the bridge priority on the specified MSTI. The valid range is from 0 to 61440, and the value must be the multiple of 4096. It ensures the probability that the switch is selected as the root bridge, and the lower values has the higher priority for the switch to be selected as the root bridge of the STP topology.

IV-7-4. MST Port Setting

To configure and display MST port setting, click **STP > MST Port Setting**.

Entry	Port	Path Cost	Priority	Port Role	Port State	Mode	Type	Designated Bridge	Designated Port ID	Designated Cost	Remaining Hop
1	GE1	20000	128	Root	Forwarding	RSTP	Boundary	32768-2C-FA-A2-6C-2D-62	128-1	20000	20
2	GE2	200000	128	Designated	Forwarding	RSTP	Boundary	32768-FC-8F-C4-0D-1A-B5	128-2	200000	20
3	GE3	20000	128	Disabled	Disabled	RSTP	Boundary	0-00-00-00-00-00-00	128-3	20000	20
4	GE4	20000	128	Disabled	Disabled	RSTP	Boundary	0-00-00-00-00-00-00	128-4	20000	20
5	GE5	20000	128	Disabled	Disabled	RSTP	Boundary	0-00-00-00-00-00-00	128-5	20000	20
6	GE6	20000	128	Disabled	Disabled	RSTP	Boundary	0-00-00-00-00-00-00	128-6	20000	20
7	GE7	20000	128	Disabled	Disabled	RSTP	Boundary	0-00-00-00-00-00-00	128-7	20000	20
8	GE8	20000	128	Disabled	Disabled	RSTP	Boundary	0-00-00-00-00-00-00	128-8	20000	20
9	GE9	20000	128	Disabled	Disabled	RSTP	Boundary	0-00-00-00-00-00-00	128-9	20000	20
10	GE10	20000	128	Disabled	Disabled	RSTP	Boundary	0-00-00-00-00-00-00	128-10	20000	20
11	GE11	20000	128	Disabled	Disabled	RSTP	Boundary	0-00-00-00-00-00-00	128-11	20000	20
12	GE12	20000	128	Disabled	Disabled	RSTP	Boundary	0-00-00-00-00-00-00	128-12	20000	20
13	GE13	20000	128	Disabled	Disabled	RSTP	Boundary	0-00-00-00-00-00-00	128-13	20000	20
14	GE14	20000	128	Disabled	Disabled	RSTP	Boundary	0-00-00-00-00-00-00	128-14	20000	20
15	GE15	20000	128	Disabled	Disabled	RSTP	Boundary	0-00-00-00-00-00-00	128-15	20000	20
16	GE16	200000	128	Designated	Forwarding	RSTP	Boundary	32768-FC-8F-C4-0D-1A-B5	128-16	200000	20
17	GE17	20000	128	Disabled	Disabled	RSTP	Boundary	0-00-00-00-00-00-00	128-17	20000	20
18	GE18	20000	128	Disabled	Disabled	RSTP	Boundary	0-00-00-00-00-00-00	128-18	20000	20
19	GE19	20000	128	Disabled	Disabled	RSTP	Boundary	0-00-00-00-00-00-00	128-19	20000	20
20	GE20	20000	128	Disabled	Disabled	RSTP	Boundary	0-00-00-00-00-00-00	128-20	20000	20
21	GE21	20000	128	Disabled	Disabled	RSTP	Boundary	0-00-00-00-00-00-00	128-21	20000	20
22	GE22	20000	128	Disabled	Disabled	RSTP	Boundary	0-00-00-00-00-00-00	128-22	20000	20
23	GE23	20000	128	Disabled	Disabled	RSTP	Boundary	0-00-00-00-00-00-00	128-23	20000	20
24	GE24	20000	128	Disabled	Disabled	RSTP	Boundary	0-00-00-00-00-00-00	128-24	20000	20
25	XGE1	2000	128	Disabled	Disabled	RSTP	Boundary	0-00-00-00-00-00-00	128-25	2000	20
26	XGE2	2000	128	Disabled	Disabled	RSTP	Boundary	0-00-00-00-00-00-00	128-26	2000	20
27	XGE3	2000	128	Disabled	Disabled	RSTP	Boundary	0-00-00-00-00-00-00	128-27	2000	20
28	XGE4	2000	128	Disabled	Disabled	RSTP	Boundary	0-00-00-00-00-00-00	128-28	2000	20
29	LAG1	20000	128	Disabled	Disabled	RSTP	Boundary	0-00-00-00-00-00-00	128-29	20000	20
30	LAG2	20000	128	Disabled	Disabled	RSTP	Boundary	0-00-00-00-00-00-00	128-30	20000	20
31	LAG3	20000	128	Disabled	Disabled	RSTP	Boundary	0-00-00-00-00-00-00	128-31	20000	20
32	LAG4	20000	128	Disabled	Disabled	RSTP	Boundary	0-00-00-00-00-00-00	128-32	20000	20
33	LAG5	20000	128	Disabled	Disabled	RSTP	Boundary	0-00-00-00-00-00-00	128-33	20000	20
34	LAG6	20000	128	Disabled	Disabled	RSTP	Boundary	0-00-00-00-00-00-00	128-34	20000	20
35	LAG7	20000	128	Disabled	Disabled	RSTP	Boundary	0-00-00-00-00-00-00	128-35	20000	20
36	LAG8	20000	128	Disabled	Disabled	RSTP	Boundary	0-00-00-00-00-00-00	128-36	20000	20

Edit

Item	Description
MSTI	Specify the port setting on the specified MSTI.
Port	Specify the interface ID or the list of interface IDs.
Path Cost	The port path cost on the specified MSTI.
Priority	The port priority on the specified MSTI.
Port Role	The current port role on the specified port. The possible values are: "Disabled", "Master", "Root", "Designated", "Alternative", and "Backup".
Port State	The current port state on the specified port. The possible values are: "Disabled", "Discarding", "Learning", and "Forwarding".
Mode	The operational STP mode on the specified port.
Type	The possible value for the port type are: <ul style="list-style-type: none"> ● Boundary: The port attaching an MST Bridge to a LAN that is not in the same region. ● Internal: The port attaching an MST Bridge to a LAN that is not in the same region.
Designated Bridge	The bridge ID of the designated bridge.
Designated Port ID	The designated port ID on the switch.
Designated Cost	The path cost of the designated port on the switch.
Remaining Hop	The remaining hops count on the specified port.

Click "Edit" button to view Edit MST Port Setting menu.

Edit MST Port Setting

MSTI	0
Port	GE1
Path Cost	<input type="text" value="0"/> (0 - 200000000) (0 = Auto)
Priority	128 ▼
Port Role	Disabled
Port State	Disabled
Mode	RSTP
Type	Boundary
Designated Bridge	0-00:00:00:00:00:00
Designated Port ID	128-1
Designated Cost	20000
Remaining Hop	20

Item	Description
Path Cost	Specify the STP port path cost on the specified MSTI.
Priority	Specify the STP port priority on the specified MSTI.

IV-7-5. Statistics

To display the STP statistics, click **STP > Statistics**.

Entry	Port	Receive BPDU			Transmit BPDU		
		Config	TCN	MSTP	Config	TCN	MSTP
<input type="checkbox"/>	1 GE1	0	0	500479	0	0	36
<input type="checkbox"/>	2 GE2	0	0	0	0	0	500493
<input type="checkbox"/>	3 GE3	0	0	0	0	0	0
<input type="checkbox"/>	4 GE4	0	0	0	0	0	0
<input type="checkbox"/>	5 GE5	0	0	0	0	0	0
<input type="checkbox"/>	6 GE6	0	0	0	0	0	186
<input type="checkbox"/>	7 GE7	0	0	0	0	0	0
<input type="checkbox"/>	8 GE8	0	0	0	0	0	0
<input type="checkbox"/>	9 GE9	0	0	0	0	0	0
<input type="checkbox"/>	10 GE10	0	0	0	0	0	0
<input type="checkbox"/>	11 GE11	0	0	0	0	0	0
<input type="checkbox"/>	12 GE12	0	0	0	0	0	0
<input type="checkbox"/>	13 GE13	0	0	0	0	0	0
<input type="checkbox"/>	14 GE14	0	0	0	0	0	0
<input type="checkbox"/>	15 GE15	0	0	0	0	0	0
<input type="checkbox"/>	16 GE16	0	0	0	0	0	209658
<input type="checkbox"/>	17 GE17	0	0	0	0	0	0
<input type="checkbox"/>	18 GE18	0	0	0	0	0	0
<input type="checkbox"/>	19 GE19	0	0	0	0	0	0
<input type="checkbox"/>	20 GE20	0	0	0	0	0	0
<input type="checkbox"/>	21 GE21	0	0	0	0	0	0
<input type="checkbox"/>	22 GE22	0	0	0	0	0	0
<input type="checkbox"/>	23 GE23	0	0	0	0	0	0
<input type="checkbox"/>	24 GE24	0	0	0	0	0	0
<input type="checkbox"/>	25 XGE1	0	0	0	0	0	0
<input type="checkbox"/>	26 XGE2	0	0	0	0	0	0
<input type="checkbox"/>	27 XGE3	0	0	0	0	0	0
<input type="checkbox"/>	28 XGE4	0	0	0	0	0	0
<input type="checkbox"/>	29 LAG1	0	0	0	0	0	0
<input type="checkbox"/>	30 LAG2	0	0	0	0	0	0
<input type="checkbox"/>	31 LAG3	0	0	0	0	0	0
<input type="checkbox"/>	32 LAG4	0	0	0	0	0	0
<input type="checkbox"/>	33 LAG5	0	0	0	0	0	0
<input type="checkbox"/>	34 LAG6	0	0	0	0	0	0
<input type="checkbox"/>	35 LAG7	0	0	0	0	0	0
<input type="checkbox"/>	36 LAG8	0	0	0	0	0	0

Clear Refresh View

Item	Description
Refresh Rate	The option to refresh the statistics automatically.
Receive BPDU (Config)	The counts of the received CONFIG BPDU.
Receive BPDU (TCN)	The counts of the received TCN BPDU.
Receive BPDU (MSTP)	The counts of the received MSTP BPDU.
Transmit BPDU (Config)	The counts of the transmitted CONFIG BPDU.
Transmit BPDU (TCN)	The counts of the transmitted TCN BPDU.
Transmit BPDU (MSTP)	The counts of the transmitted MSTP BPDU.
Clear	Clear the statistics for the selected interfaces
View	View the statistics for the interface.

Click "**View**" button to view the STP Port Statistic menu.

STP Port Statistic

Port	GE1
Refresh Rate	<input checked="" type="radio"/> None <input type="radio"/> 5 sec <input type="radio"/> 10 sec <input type="radio"/> 30 sec
Receive BPDU	
Config	0
TCN	0
MSTP	0
Transmit BPDU	
Config	0
TCN	0
MSTP	0

Item	Description
Refresh Rate	The option to refresh the statistics automatically.
Clear	Clear the statistics for the selected interfaces.

IV-8. Discovery

Use this section to configure LLDP.

IV-8-1. LLDP

LLDP (Link Layer Discovery Protocol)is a one-way protocol; there are no request/response sequences. Information is advertised by stations implementing the transmit function, and is received and processed by stations implementing the receive function. The LLDP category contains LLDP and LLDP-MED (Link Layer Discovery Protocol-Media Endpoint Discovery)pages.

IV-8-1-1. Property

To display LLDP Property Setting web page, click **Discovery > LLDP > Property**.

LLDP

State	<input checked="" type="checkbox"/> Enable
LLDP Handling	<input type="radio"/> Filtering <input type="radio"/> Bridging <input checked="" type="radio"/> Flooding
TLV Advertise Interval	<input style="width: 100px;" type="text" value="30"/> Sec (5 - 32767, default 30)
Hold Multiplier	<input style="width: 100px;" type="text" value="4"/> (2 - 10, default 4)
Reinitializing Delay	<input style="width: 100px;" type="text" value="2"/> Sec (1 - 10, default 2)
Transmit Delay	<input style="width: 100px;" type="text" value="2"/> Sec (1 - 8191, default 2)

LLDP-MED

Fast Start Repeat Count	<input style="width: 100px;" type="text" value="3"/> (1 - 10, default 3)
--------------------------------	--

Item	Description
State	Enable/ Disable LLDP protocol on this switch.
LLDP Handling	Select LLDP PDU handling action to be filtered, bridging or flooded when LLDP is globally disabled. <ul style="list-style-type: none"> ● Filtering: Deletes the packet. ● Bridging: (VLAN-aware flooding) Forwards the packet to all VLAN members. ● Flooding: Forwards the packet to all ports
TLV Advertise Interval	Select the interval at which frames are transmitted. The default is 30 seconds, and the valid range is 5–32767 seconds.
Hold Multiplier	Select the multiplier on the transmit interval to assign to TTL (range 2–10, default = 4).
Reinitializing Delay	Select the delay before a re-initialization (range 1–10 seconds, default = 2).
Transmit Delay	Select the delay after an LLDP frame is sent (range 1–8191 seconds, default = 3).
Fast Start Repeat Count	Select fast start repeat count when port link up (range 1–10, default = 3).

IV-8-1-2. Port Setting

To display LLDP Port Setting, click **Discovery > LLDP > Port Setting**.



Entry	Port	Mode	Selected TLV	
<input type="checkbox"/>	1	GE1	Normal	802.1 PVID
<input type="checkbox"/>	2	GE2	Normal	802.1 PVID
<input type="checkbox"/>	3	GE3	Normal	802.1 PVID
<input type="checkbox"/>	4	GE4	Normal	802.1 PVID
<input type="checkbox"/>	5	GE5	Normal	802.1 PVID
<input type="checkbox"/>	6	GE6	Normal	802.1 PVID
<input type="checkbox"/>	7	GE7	Normal	802.1 PVID
<input type="checkbox"/>	8	GE8	Normal	802.1 PVID
<input type="checkbox"/>	9	GE9	Normal	802.1 PVID
<input type="checkbox"/>	10	GE10	Normal	802.1 PVID
<input type="checkbox"/>	11	GE11	Normal	802.1 PVID
<input type="checkbox"/>	12	GE12	Normal	802.1 PVID
<input type="checkbox"/>	13	GE13	Normal	802.1 PVID
<input type="checkbox"/>	14	GE14	Normal	802.1 PVID
<input type="checkbox"/>	15	GE15	Normal	802.1 PVID
<input type="checkbox"/>	16	GE16	Normal	802.1 PVID
<input type="checkbox"/>	17	GE17	Normal	802.1 PVID
<input type="checkbox"/>	18	GE18	Normal	
<input type="checkbox"/>	19	GE19	Normal	802.1 PVID
<input type="checkbox"/>	20	GE20	Normal	802.1 PVID
<input type="checkbox"/>	21	GE21	Normal	802.1 PVID
<input type="checkbox"/>	22	GE22	Normal	802.1 PVID
<input type="checkbox"/>	23	GE23	Normal	802.1 PVID
<input type="checkbox"/>	24	GE24	Normal	802.1 PVID
<input type="checkbox"/>	25	XGE1	Normal	802.1 PVID
<input type="checkbox"/>	26	XGE2	Normal	802.1 PVID
<input type="checkbox"/>	27	XGE3	Normal	802.1 PVID
<input type="checkbox"/>	28	XGE4	Normal	802.1 PVID

Item	Description
Port	Port Name.
Mode	The port LLDP mode.
Selected TLV	The Selected LLDP TLV.

Click "**Edit**" button to view Edit Port Setting menu.

Edit Port Setting

The screenshot shows the 'Edit Port Setting' configuration window. It is divided into four main sections:

- Port:** GE1
- Mode:** Radio buttons for Transmit, Receive, Normal (selected), and Disable.
- Optional TLV:** Two lists. 'Available TLV' includes Port Description, System Name, System Description, System Capabilities, and 802.3 MAC-PHY. 'Selected TLV' includes 802.1 PVID.
- 802.1 VLAN Name:** Two lists. 'Available VLAN' includes VLAN 1 and VLAN 2. 'Selected VLAN' is empty.

At the bottom of the window are two buttons: 'Apply' and 'Close'.

Item	Description
Port	Select specified port or all ports to configure LLDP state.
Mode	Select the transmission state of LLDP port interface. <ul style="list-style-type: none"> ● Disable: Disable the transmission of LLDP PDUs. ● RX Only: Receive LLDP PDUs only. ● TX Only: Transmit LLDP PDUs only. ● TX And RX: Transmit and receive LLDP PDUs both.
Optional TLV	Select the LLDP optional TLVs to be carried (multiple selection is allowed). <ul style="list-style-type: none"> ● System Name ● Port Description ● System Description ● System Capability ● 802.3 MAC-PHY ● 802.3 Link Aggregation ● 802.3 Maximum Frame Size ● Management Address ● 802.1 PVID.
802.1 VLAN Name	Select the VLAN Name ID to be carried (multiple selection is allowed).

IV-8-1-3. MED Network Policy

To display MED Network Policy Setting web page, click **Discovery > LLDP > MED Network Policy**.

Edit MED Network Policy

Policy ID	undefined
Application	Voice
VLAN	2 Range (1 - 4094)
VLAN Tag	<input type="radio"/> Tagged <input checked="" type="radio"/> Untagged
Priority	0
DSCP	0

Apply Close

Item	Description
Policy ID	Showing the MED Network is defined or undefined.
Application	Define an application for LLDP. <ul style="list-style-type: none"> ● Voice ● Voice Signaling ● Guest Voice ● Guest Voice Signaling ● Softphone Voice ● Video Conferencing ● Streaming Video ● Video Signaling
VLAN	Configure VLAN (Valid values are from 1 to 4094)
VLAN Tag	Define VLAN Tag (Tagged/Untagged). VLAN tagging is used to tell which packet belongs to which VLAN on the other side. To make recognition easier, a packet is tagged with a VLAN tag in the Ethernet frame.
Priority	Define the priority
DSCP	Enter a Differentiated Services Code Point (DSCP)

IV-8-1-4. MED Port Setting

To display MED Network Policy Setting web page, click **Discovery > LLDP > MED Port Setting**.

MED Port Setting Table

Entry	Port	State	Network Policy		Location	Inventory
			Active	Application		
<input type="checkbox"/>	1 GE1	Enabled	Yes		No	No
<input type="checkbox"/>	2 GE2	Enabled	Yes		No	No
<input type="checkbox"/>	3 GE3	Enabled	Yes		No	No
<input type="checkbox"/>	4 GE4	Enabled	Yes		No	No
<input type="checkbox"/>	5 GE5	Enabled	Yes		No	No
<input type="checkbox"/>	6 GE6	Enabled	Yes		No	No
<input type="checkbox"/>	7 GE7	Enabled	Yes		No	No
<input type="checkbox"/>	8 GE8	Enabled	Yes		No	No
<input type="checkbox"/>	9 GE9	Enabled	Yes		No	No
<input type="checkbox"/>	10 GE10	Enabled	Yes		No	No
<input type="checkbox"/>	11 GE11	Enabled	Yes		No	No
<input type="checkbox"/>	12 GE12	Enabled	Yes		No	No
<input type="checkbox"/>	13 GE13	Enabled	Yes		No	No
<input type="checkbox"/>	14 GE14	Enabled	Yes		No	No
<input type="checkbox"/>	15 GE15	Enabled	Yes		No	No
<input type="checkbox"/>	16 GE16	Enabled	Yes		No	No
<input type="checkbox"/>	17 GE17	Enabled	Yes		No	No
<input type="checkbox"/>	18 GE18	Enabled	Yes		No	No
<input type="checkbox"/>	19 GE19	Enabled	Yes		No	No
<input type="checkbox"/>	20 GE20	Enabled	Yes		No	No
<input type="checkbox"/>	21 GE21	Enabled	Yes		No	No
<input type="checkbox"/>	22 GE22	Enabled	Yes		No	No
<input type="checkbox"/>	23 GE23	Enabled	Yes		No	No
<input type="checkbox"/>	24 GE24	Enabled	Yes		No	No
<input type="checkbox"/>	25 GE25	Enabled	Yes		No	No
<input type="checkbox"/>	26 GE26	Enabled	Yes		No	No
<input type="checkbox"/>	27 GE27	Enabled	Yes		No	No
<input type="checkbox"/>	28 GE28	Enabled	Yes		No	No
<input type="checkbox"/>	29 GE29	Enabled	Yes		No	No
<input type="checkbox"/>	30 GE30	Enabled	Yes		No	No

Item	Description
Entry	Entry of number.
Port	Port Name.
State	Status of LLDP (Enabled or Disabled).
Network Policy	Display LLDP whether active.
Location	MED location.
Inventory	MED Inventory.

Click "**Edit**" button to view MED Port Setting menu.

Edit MED Port Setting

Port	GE1			
State	<input checked="" type="checkbox"/> Enable			
Optional TLV	<table style="width: 100%; border-collapse: collapse;"> <tr> <td style="width: 50%; border: 1px solid #ccc; padding: 5px;"> Available TLV Location Extended Power-via-MDI Inventory </td> <td style="width: 10%; text-align: center; padding: 5px;"> > < </td> <td style="width: 40%; border: 1px solid #ccc; padding: 5px;"> Selected TLV Network Policy </td> </tr> </table>	Available TLV Location Extended Power-via-MDI Inventory	> <	Selected TLV Network Policy
Available TLV Location Extended Power-via-MDI Inventory	> <	Selected TLV Network Policy		
Network policy	<table style="width: 100%; border-collapse: collapse;"> <tr> <td style="width: 50%; border: 1px solid #ccc; padding: 5px;"> Available Policy </td> <td style="width: 10%; text-align: center; padding: 5px;"> > < </td> <td style="width: 40%; border: 1px solid #ccc; padding: 5px;"> Selected Policy </td> </tr> </table>	Available Policy	> <	Selected Policy
Available Policy	> <	Selected Policy		

Location	
Coordinate	<input style="width: 90%;" type="text"/> (16 pairs of hexadecimal characters)
Civic	<input style="width: 90%;" type="text"/> (6-160 pairs of hexadecimal characters)
ECS ELIN	<input style="width: 90%;" type="text"/> (10-25 pairs of hexadecimal characters)

Item	Description
Port	Port Name.
State	Enable/ Disable MED Port on this switch.
Optional TLV	Select the LLDP optional TLVs to be carried (multiple selection is allowed). <ul style="list-style-type: none"> ● Location ● Extended Power-via-MDI ● Inventory ● Network Policy
Network Policy	Select the Network Policy to be carried
Coordinate	Configures a coordinate-based location for an endpoint device.
Civic	Configures a civic-address-based location for Link Layer Discovery Protocol-Media Endpoint Discovery (LLDP-MED)
ECS ELIN	Configures an Emergency Call Service (ECS) based location for Link Layer Discovery Protocol Media Endpoint Device (LLDP-MED)

IV-8-1-5. Packet View

To display LLDP Overloading, click **Discovery > LLDP > Packet View**.

Entry	Port	In-Use (Bytes)	Available (Bytes)	Operational Status
1	GE1	48	1440	Not Overloading
2	GE2	48	1440	Not Overloading
3	GE3	48	1440	Not Overloading
4	GE4	48	1440	Not Overloading
5	GE5	48	1440	Not Overloading
6	GE6	48	1440	Not Overloading
7	GE7	48	1440	Not Overloading
8	GE8	48	1440	Not Overloading
9	GE9	48	1440	Not Overloading
10	GE10	49	1439	Not Overloading
11	GE11	49	1439	Not Overloading
12	GE12	49	1439	Not Overloading
13	GE13	49	1439	Not Overloading
14	GE14	49	1439	Not Overloading
15	GE15	49	1439	Not Overloading
16	GE16	49	1439	Not Overloading
17	GE17	49	1439	Not Overloading
18	GE18	65	1423	Not Overloading
19	GE19	49	1439	Not Overloading
20	GE20	49	1439	Not Overloading
21	GE21	49	1439	Not Overloading
22	GE22	49	1439	Not Overloading
23	GE23	49	1439	Not Overloading
24	GE24	49	1439	Not Overloading
25	XGE1	49	1439	Not Overloading
26	XGE2	49	1439	Not Overloading
27	XGE3	49	1439	Not Overloading
28	XGE4	49	1439	Not Overloading

Item	Description
Port	Port Name.
In-Use (Bytes)	Total number of bytes of LLDP information in each packet.
Available (Bytes)	Total number of available bytes left for additional LLDP information in each packet.
Operational Status	Overloading or not.

Click "**Detail**" button to view Packet View Detail menu.

Packet View Detail

Port	GE1
Mandatory TLVs	
Size (Bytes)	21
Operational Status	Transmitted
MED Capabilities	
Size (Bytes)	9
Operational Status	Transmitted
MED Location	
Size (Bytes)	0
Operational Status	Transmitted
MED Network Policy	
Size (Bytes)	10
Operational Status	Transmitted
MED Inventory	
Size (Bytes)	0
Operational Status	Transmitted
MED Extended Power via MDI	
Size (Bytes)	0
Operational Status	Transmitted
802.3 TLVs	
Size (Bytes)	0
Operational Status	Transmitted

Optional TLVs	
Size (Bytes)	0
Operational Status	Transmitted
802.1 TLVs	
Size (Bytes)	8
Operational Status	Transmitted
Total	
In-Use (Bytes)	48
Available (Bytes)	1440

Item	Description
Port	Port Name.
Mandatory TLVs	Total mandatory TLV byte size. Status is sent or overloading.
MED Capabilities	Total MED Capabilities TLV byte size. Status is sent or overloading.
MED Location	Total MED Location byte size. Status is sent or overloading.
MED Network Policy	Total MED Network Policy byte size. Status is sent or overloading.
MED Inventory	Total MED Inventory byte size. Status is sent or overloading.
MED Extended Power via MDI	Total MED Extended Power via MDI byte size. Status is sent or overloading.
802.3 TLVs	Total 802.3 TLVs byte size. Status is sent or overloading.
Optional TLVs	Total Optional TLV byte size. Status is sent or overloading.
802.1 TLVs	Total 802.1 TLVs byte size. Status is sent or overloading.
Total	Total number of bytes of LLDP information in each packet.

IV-8-1-6. Local Information

Use the LLDP Local Information to view LLDP local device information.

To display LLDP Local Device, click **Discovery > LLDP > Local Information**.

Device Summary

Chassis ID Subtype	MAC address
Chassis ID	FC:8F:C4:0D:1D:EC
System Name	Switch
System Description	GS-5216PLC
Supported Capabilities	Bridge
Enabled Capabilities	Bridge
Port ID Subtype	Local

Entry	Port	LLDP State
<input type="radio"/>	1 GE1	Normal
<input type="radio"/>	2 GE2	Normal
<input type="radio"/>	3 GE3	Normal
<input type="radio"/>	4 GE4	Normal
<input type="radio"/>	5 GE5	Normal
<input type="radio"/>	6 GE6	Normal
<input type="radio"/>	7 GE7	Normal
<input type="radio"/>	8 GE8	Normal
<input type="radio"/>	9 GE9	Normal
<input type="radio"/>	10 GE10	Normal
<input type="radio"/>	11 GE11	Normal
<input type="radio"/>	12 GE12	Normal
<input type="radio"/>	13 GE13	Normal
<input type="radio"/>	14 GE14	Normal
<input type="radio"/>	15 GE15	Normal
<input type="radio"/>	16 GE16	Normal
<input type="radio"/>	17 GE17	Normal
<input type="radio"/>	18 GE18	Normal
<input type="radio"/>	19 GE19	Normal
<input type="radio"/>	20 GE20	Normal
<input type="radio"/>	21 GE21	Normal
<input type="radio"/>	22 GE22	Normal
<input type="radio"/>	23 GE23	Normal
<input type="radio"/>	24 GE24	Normal
<input type="radio"/>	25 XGE1	Normal
<input type="radio"/>	26 XGE2	Normal
<input type="radio"/>	27 XGE3	Normal
<input type="radio"/>	28 XGE4	Normal

Item	Description
Chassis ID Subtype	Type of chassis ID, such as the MAC address.
Chassis ID	Identifier of chassis. Where the chassis ID subtype is a MAC address, the MAC address of the switch is displayed.
System Name	Name of switch.
System Description	Description of the switch.
Capabilities Supported	Primary functions of the device, such as Bridge, WLAN AP, or Router.
Capabilities Enabled	Primary enabled functions of the device.
Port ID Subtype	Type of the port identifier that is shown.
LLDP Status	LLDP Tx and Rx abilities.
LLDP Med Status	LLDP MED enable state.

Click “**Detail**” button on the page to view detail information of the selected port.

Local Information Detail

Chassis ID Subtype	MAC address
Chassis ID	74:DA:38:17:6E:7A
System Name	Switch
System Description	24-Port Gigabit PoE+ Smart Managed Switch with 4 RJ45/SFP Combo Ports
Supported Capabilities	Bridge
Enabled Capabilities	Bridge
Port ID	GE1
Port ID Subtype	Local
Port Description	

Management Address Table			
Address Subtype	Address	Interface Subtype	Interface Number
0 results found.			

MAC/PHY Detail	
Auto-Negotiation Supported	N/A
Auto-Negotiation Enabled	N/A
Auto-Negotiation Advertised Capabilities	N/A
Operational MAU Type	N/A

802.3 Detail	
802.3 Maximum Frame Size	N/A

802.3 Link Aggregation	
Aggregation Capability	N/A
Aggregation Status	N/A
Aggregation Port ID	N/A

MED Detail

Capabilities Supported	Capabilities , Network policy
Current Capabilities	Capabilities , Network policy
Device Class	Network Connectivity
PoE Device Type	N/A
PoE Power Source	N/A
PoE Power Priority	N/A
PoE Power Value	N/A
Hardware Revision	N/A
Firmware Revision	N/A
Software Revision	N/A
Serial Number	N/A
Manufacturer Name	N/A
Model Name	N/A
Asset ID	N/A

Location Information

Civic	N/A
Coordinate	N/A
ECS ELIN	N/A

Network Policy Table

Application Type	VLAN	VLAN Type	Priority	DSCP
0 results found.				

Close

IV-8-1-7. Neighbor

Use the LLDP Neighbor page to view LLDP neighbors information.

To display LLDP Remote Device, click **Discovery > LLDP > Neighbor**.

Neighbor Table

Showing All entries Showing 0 to 0 of 0 entries 🔍

<input type="checkbox"/>	Local Port	Chassis ID Subtype	Chassis ID	Port ID Subtype	Port ID	System Name	Time to Live
0 results found.							

First Previous 1 Next Last

Clear Refresh Detail

Item	Description
Local Port	Number of the local port to which the neighbor is connected.
Chassis ID Subtype	Type of chassis ID (for example, MAC address).
Port ID Subtype	Type of the port identifier that is shown.
Port ID	Identifier of port.
System Name	Published name of the switch.
Time to Live	Time interval in seconds after which the information for this neighbor is deleted.

Click **“detail”** to view selected neighbor detail information.

Neighbor Information Detail

Local Port

Basic Detail

Chassis ID Subtype	Unknown
Chassis ID	
Port ID Subtype	Unknown
Port ID	
Port Description	
System Name	
System Description	
Supported Capabilities	N/A
Enabled Capabilities	N/A

Management Address Table

Address Subtype	Address	Interface Subtype	Interface Number
0 results found.			

MAC/PHY Detail

Auto-Negotiation Supported	N/A
Auto-Negotiation Enabled	N/A
Auto-Negotiation Advertised Capabilities	N/A
Operational MAU Type	N/A

802.3 Power via MDI	
MDI Power Support Port Class	N/A
PSE MDI Power Support	N/A
PSE MDI Power State	N/A
PSE Power Pair Control Ability	N/A
PSE Power Pair	N/A
PSE Power Class	N/A
Power Type	N/A
Power Source	N/A
Power Priority	N/A
PD Request Power Value	N/A
PSE Allocated Power Value	N/A
802.3 Detail	
802.3 Maximum Frame Size	N/A
802.3 Link Aggregation	
Aggregation Capability	N/A
Aggregation Status	N/A
Aggregation Port ID	N/A
802.1 VLAN and Protocol	
PVID	
VLAN Name	N/A
MED Detail	
Capabilities Supported	N/A
Current Capabilities	N/A
Device Class	N/A
PoE Device Type	N/A
PoE Power Source	N/A
PoE Power Priority	N/A
PoE Power Value	N/A
Hardware Revision	N/A
Firmware Revision	N/A
Software Revision	N/A
Serial Number	N/A
Manufacturer Name	N/A
Model Name	N/A
Asset ID	N/A

Location Information	
Civic	N/A
Coordinate	N/A
ECS ELIN	N/A

Network Policy Table				
Application Type	VLAN	VLAN Type	Priority	DSCP
0 results found.				

Close

IV-8-1-8. Statistics

The Link Layer Discovery Protocol (LLDP) Statistics page displays summary and per-port information for LLDP frames transmitted and received on the switch.

To display LLDP Statistics status, click **Discovery > LLDP > Statistics**.

Global Statistics

Insertions	4
Deletions	2
Drops	0
AgeOuts	0

Clear Refresh

Entry	Port	Transmit Frame		Receive Frame			Receive TLV		Neighbor Timeout
		Total	Total	Total	Discard	Error	Discard	Unrecognized	
<input type="checkbox"/>	1	GE1	112157	74775	0	0	0	0	0
<input type="checkbox"/>	2	GE2	112169	0	0	0	0	0	0
<input type="checkbox"/>	3	GE3	0	0	0	0	0	0	0
<input type="checkbox"/>	4	GE4	0	0	0	0	0	0	0
<input type="checkbox"/>	5	GE5	0	0	0	0	0	0	0
<input type="checkbox"/>	6	GE6	39	0	0	0	0	0	0
<input type="checkbox"/>	7	GE7	0	0	0	0	0	0	0
<input type="checkbox"/>	8	GE8	0	0	0	0	0	0	0
<input type="checkbox"/>	9	GE9	0	0	0	0	0	0	0
<input type="checkbox"/>	10	GE10	0	0	0	0	0	0	0
<input type="checkbox"/>	11	GE11	0	0	0	0	0	0	0
<input type="checkbox"/>	12	GE12	0	0	0	0	0	0	0
<input type="checkbox"/>	13	GE13	0	0	0	0	0	0	0
<input type="checkbox"/>	14	GE14	0	0	0	0	0	0	0
<input type="checkbox"/>	15	GE15	0	0	0	0	0	0	0
<input type="checkbox"/>	16	GE16	41974	0	0	0	0	0	0
<input type="checkbox"/>	17	GE17	0	0	0	0	0	0	0
<input type="checkbox"/>	18	GE18	0	0	0	0	0	0	0
<input type="checkbox"/>	19	GE19	0	0	0	0	0	0	0
<input type="checkbox"/>	20	GE20	0	0	0	0	0	0	0
<input type="checkbox"/>	21	GE21	0	0	0	0	0	0	0
<input type="checkbox"/>	22	GE22	0	0	0	0	0	0	0
<input type="checkbox"/>	23	GE23	0	0	0	0	0	0	0
<input type="checkbox"/>	24	GE24	0	0	0	0	0	0	0
<input type="checkbox"/>	25	XGE1	0	0	0	0	0	0	0
<input type="checkbox"/>	26	XGE2	0	0	0	0	0	0	0
<input type="checkbox"/>	27	XGE3	0	0	0	0	0	0	0
<input type="checkbox"/>	28	XGE4	0	0	0	0	0	0	0

Clear Refresh

Item	Description
Insertions	The number of times the complete set of information advertised by a particular MAC Service Access Point (MSAP) has been inserted into tables associated with the remote systems.
Deletions	The number of times the complete set of information advertised by MSAP has been deleted from tables associated with the remote systems.
Drops	The number of times the complete set of information advertised by MSAP could not be entered into tables associated with the remote systems because of insufficient resources.
Age Outs	The number of times the complete set of information advertised by MSAP has been deleted from tables associated with the remote systems because the information timeliness interval has expired.
Statistics Table	
Port	Interface or port number.
Transmit Frame Total	Number of LLDP frames transmitted on the corresponding port.
Receive Frame Total	Number of LLDP frames received by this LLDP agent on the corresponding port, while the LLDP agent is enabled.
Receive Frame Discard	Number of LLDP frames discarded for any reason by the LLDP agent on the corresponding port.
Receive Frame Error	Number of invalid LLDP frames received by the LLDP agent on the corresponding port, while the LLDP agent is enabled.
Receive TLV Discard	Number of TLVs of LLDP frames discarded for any reason by the LLDP agent on the corresponding port.
Receive TLV Unrecognized	Number of TLVs of LLDP frames that are unrecognized while the LLDP agent is enabled.
Neighbor Timeout	Number of age out LLDP frames.

IV-9. Multicast

Use this section to configure Multicast.

IV-9-1. General

Use the General pages to configure settings of IGMP and MLD common function.

IV-9-1-1. Property

To display multicast general property Setting web page, click **Multicast> General> Property**.

The screenshot shows a web interface for configuring multicast properties. It features three main sections:

- Unknown Multicast Action:** Contains three radio buttons. 'Flood' is selected, 'Drop' is unselected, and 'Forward to Router Port' is unselected.
- Multicast Forward Method:** A header section containing two sub-sections:
 - IPv4:** Contains two radio buttons. 'DMAC-VID' is selected, and 'DIP-VID' is unselected.
 - IPv6:** Contains two radio buttons. 'DMAC-VID' is selected, and 'DIP-VID' is unselected.
- Apply:** A button located at the bottom left of the configuration area.

Item	Description
Unknown Multicast Action	Set the unknown multicast action <ul style="list-style-type: none"> ● Flood: flood the unknown multicast data. ● Drop: drop the unknown multicast data. ● Router port: forward the unknown multicast data to router port.
IPv4	Set the ipv4 multicast forward method. <ul style="list-style-type: none"> ● MAC-VID: forward method dmac+vid. ● DIP-VID: forward method dip+vid.
IPv6	Set the ipv6 multicast forward method. <ul style="list-style-type: none"> ● MAC-VID: forward method dmac+vid. ● DIP-VID: forward method dip+vid(dip is ipv6 low 32 bit).

IV-9-1-2. Group Address

This page allow user to browse all multicast groups that dynamic learned or statically added.

To display Multicast General Group web page, click **Multicast> General > Group Address**.

Group Address Table

IP Version

Showing entries

Showing 0 to 0 of 0 entries

<input type="checkbox"/>	VLAN	Group Address	Member	Type	Life (Sec)
0 results found.					

Item	Description
IP Version	IP Version <ul style="list-style-type: none"> ● IPv4: ipv4 multicast group ● IPv6: ipv6 multicast group
VLAN	The VLAN ID of group.
Group Address	The group IP address.
Member	The member ports of group.
Type	The type of group. Static or Dynamic.
Life(Sec)	The life time of this dynamic group.

Click **“Add”** or **“Edit”** button to view Add or Edit Group Address menu.

Add Group Address

VLAN

IP Version

Group Address

Member

Available Port

- GE1
- GE2
- GE3
- GE4
- GE5
- GE6
- GE7
- GE8

Selected Port

-
-
-
-
-
-
-
-

Edit Group Address

VLAN	1
Group Address	225.0.0.1
Member	Available Port
	Selected Port
	GE2 GE3 GE4 GE5 GE6 GE7 GE8 GE9
	GE1

Apply Close

Item	Description
VLAN	The VLAN ID of group.
IP Version	IP Version <ul style="list-style-type: none">● IPv4: ipv4 multicast group● IPv6: ipv6 multicast group
Group Address	The group IP address.
Member	The member ports of group. <ul style="list-style-type: none">● Available Port: Optional port member● Selected Port: Selected port member

IV-9-1-3. Router Port

This page allow user to browse all router port information. The static and forbidden router port can set by user.

To display multicast router port table web page, click **Multicast > General > Router Port**.

Router Port Table

IP Version

Showing entries

Showing 0 to 0 of 0 entries

<input type="checkbox"/>	VLAN	Member	Static Port	Forbidden Port	Life (Sec)
0 results found.					

Item	Description
IP Version	IP Version <ul style="list-style-type: none">● IPv4: ipv4 multicast router● IPv6: ipv6 multicast router
VLAN	The VLAN ID router entry.
Member	Router Port member (include static and learned port member).
Static Port	Static router port member.
Forbidden	Forbidden router port member.
Life (Sec)	The expiry time of the router entry.

Click "**Add**" or "**Edit**" button to view Add/Edit Router Port menu.

Add Router Port

VLAN	Available VLAN	Selected VLAN
	1	
IP Version	IPv4 ▼	
Type	<input checked="" type="radio"/> Static <input type="radio"/> Forbidden	
Port	Available Port	Selected Port
	GE1 GE2 GE3 GE4 GE5 GE6 GE7 GE8	
<input type="button" value="Apply"/> <input type="button" value="Close"/>		

Edit Router Port

VLAN	1	
IP Version	IPv4	
Type	<input checked="" type="radio"/> Static <input type="radio"/> Forbidden	
Port	Available Port	Selected Port
	GE2 GE3 GE4 GE5 GE6 GE7 GE8 GE9	GE1
<input type="button" value="Apply"/> <input type="button" value="Close"/>		

Item	Description
VLAN	The VLAN ID for router entry <ul style="list-style-type: none"> ● Available VLAN: Optional VLAN member ● Selected VLAN: Selected VLAN member.
IP Version	IP Version <ul style="list-style-type: none"> ● IPv4: ipv4 multicast router ● IPv6: ipv6 multicast router
Type	The router port type <ul style="list-style-type: none"> ● Static: static router port ● Forbidden: forbidden router port, can't learn dynamic router port member
Port	The member ports of router entry. <ul style="list-style-type: none"> ● Available Port: Optional router port member ● Selected Port: Selected router port member

IV-9-1-4. Forward All

This page allow user to browse all forward port information.

Forward All Table

IP Version

Showing entries Showing 0 to 0 of 0 entries

<input type="checkbox"/>	VLAN	Static Port	Forbidden Port
0 results found.			

Item	Description
IP Version	IP Version <ul style="list-style-type: none"> ● IPv4 ● IPv6
VLAN	The VLAN ID entry.
Static Port	Static port member.
Forbidden	Forbidden port member.

Click "**Add**" or "**Edit**" button to view Add/Edit Forward All menu

Add Forward All

Item	Description
VLAN	The VLAN ID for forwarding entry <ul style="list-style-type: none"> ● Available VLAN: Optional VLAN member ● Selected VLAN: Selected VLAN member.
IP Version	IP Version <ul style="list-style-type: none"> ● IPv4 ● IPv6
Type	The router port type <ul style="list-style-type: none"> ● Static ● Forbidden
Port	The member ports of forward port entry. <ul style="list-style-type: none"> ● Available Port: Optional port member ● Selected Port: Selected port member

IV-9-1-5. Throttling

This page allow user to browse throttling port information.

Multicast throttling sets a maximum number of multicast groups that a port can join at the same time. When the maximum number of groups is reached on a port, the switch can take one of two actions; either “deny” or “replace”. If the action is set to deny, any new multicast join reports will be dropped. If the action is set to replace, the switch randomly removes an existing group and replaces it with the new multicast group.

Throttling Table

IP Version

<input type="checkbox"/>	Entry	Port	Max Group	Exceed Action
<input type="checkbox"/>	1	GE1	256	Deny
<input type="checkbox"/>	2	GE2	256	Deny
<input type="checkbox"/>	3	GE3	256	Deny
<input type="checkbox"/>	4	GE4	256	Deny
<input type="checkbox"/>	5	GE5	256	Deny
<input type="checkbox"/>	6	GE6	256	Deny
<input type="checkbox"/>	7	GE7	256	Deny
<input type="checkbox"/>	8	GE8	256	Deny
<input type="checkbox"/>	9	GE9	256	Deny
<input type="checkbox"/>	10	GE10	256	Deny
<input type="checkbox"/>	11	GE11	256	Deny
<input type="checkbox"/>	12	GE12	256	Deny
<input type="checkbox"/>	13	GE13	256	Deny
<input type="checkbox"/>	14	GE14	256	Deny
<input type="checkbox"/>	15	GE15	256	Deny
<input type="checkbox"/>	16	GE16	256	Deny
<input type="checkbox"/>	17	GE17	256	Deny
<input type="checkbox"/>	18	GE18	256	Deny
<input type="checkbox"/>	19	GE19	256	Deny
<input type="checkbox"/>	20	GE20	256	Deny
<input type="checkbox"/>	21	GE21	256	Deny
<input type="checkbox"/>	22	GE22	256	Deny
<input type="checkbox"/>	23	GE23	256	Deny
<input type="checkbox"/>	24	GE24	256	Deny
<input type="checkbox"/>	25	GE25	256	Deny
<input type="checkbox"/>	26	GE26	256	Deny
<input type="checkbox"/>	27	GE27	256	Deny
<input type="checkbox"/>	28	GE28	256	Deny
<input type="checkbox"/>	29	GE29	256	Deny

Item	Description
IP Version	IP Version <ul style="list-style-type: none"> ● IPv4 ● IPv6
Entry	Port number
Port	Port name
Max Group	Display the maximum number of multicast groups an interface can join at the same time.
Exceed action	Display the status of the action to take when the maximum number of multicast groups for the interface has been exceeded.

Click "**Add**" or "**Edit**" button to view Add/Edit Throttling Port menu

Edit Throttling

Port	GE1
IP Version	IPv4
Max Group	<input type="text" value="256"/> (0 - 256)
Exceed Action	<input checked="" type="radio"/> Deny <input type="radio"/> Replace

Item	Description
Port	Port name
IP Version	P Version <input checked="" type="radio"/> IPv4 <input checked="" type="radio"/> IPv6
Max Group	Sets the maximum number of multicast groups an interface can join at the same time. Range: 0-256 Default: 256
Exceed action	Sets the action to take when the maximum number of multicast groups for the interface has been exceeded. Deny: The new multicast group join report is dropped Replace: The new multicast group replaces an existing group

IV-9-1-6. Filtering Profile

This page allow user to browse filtering profile information.

Filtering Profile Table

IP Version

Showing entries Showing 0 to 0 of 0 entries

Profile ID	Start Address	End Address	Action
0 results found.			

Item	Description
IP Version	IP Version <ul style="list-style-type: none"> ● IPv4 ● IPv6
Profile ID	Display the current ID.
Start Address	Display the current Start Address.
End Address	Display the current End Address.
Action	Display the current action.

Click "**Add**" or "**Edit**" button to view Add/Edit Filtering Profile menu.

Add Profile

Profile ID	<input style="width: 80%;" type="text"/> (1 - 128)
IP Version	<input style="width: 80%;" type="text" value="IPv4"/>
Start Address	<input style="width: 80%;" type="text"/>
End Address	<input style="width: 80%;" type="text"/>
Action	<input checked="" type="radio"/> Allow <input type="radio"/> Deny

Item	Description
Profile ID	Enter the ID of this particular profile
IP Version	IP Version <ul style="list-style-type: none"> ● IPv4 ● IPv6
Start Address	Specify a multicast group range by entering a start IP address.
End Address	Specify a multicast group range by entering an end IP address.

Action	<p>Sets the access mode of the profile either Allow or Deny.</p> <p>Allow: Multicast join reports are processed when a multicast group falls within the controlled range.</p> <p>Deny: When the access mode is set to, multicast join reports are only processed when the multicast group is not in the controlled range.</p>
--------	---

IV-9-1-7. Filtering Binding

This page allow user to browse filtering binding information.

Filtering Binding Table

IP Version

Entry	Port	Profile ID
<input type="checkbox"/>	1	GE1
<input type="checkbox"/>	2	GE2
<input type="checkbox"/>	3	GE3
<input type="checkbox"/>	4	GE4
<input type="checkbox"/>	5	GE5
<input type="checkbox"/>	6	GE6
<input type="checkbox"/>	7	GE7
<input type="checkbox"/>	8	GE8
<input type="checkbox"/>	9	GE9
<input type="checkbox"/>	10	GE10
<input type="checkbox"/>	11	GE11
<input type="checkbox"/>	12	GE12
<input type="checkbox"/>	13	GE13
<input type="checkbox"/>	14	GE14
<input type="checkbox"/>	15	GE15
<input type="checkbox"/>	16	GE16
<input type="checkbox"/>	17	GE17
<input type="checkbox"/>	18	GE18
<input type="checkbox"/>	19	GE19
<input type="checkbox"/>	20	GE20
<input type="checkbox"/>	21	GE21
<input type="checkbox"/>	22	GE22
<input type="checkbox"/>	23	GE23
<input type="checkbox"/>	24	GE24
<input type="checkbox"/>	25	GE25
<input type="checkbox"/>	26	GE26
<input type="checkbox"/>	27	GE27
<input type="checkbox"/>	28	GE28
<input type="checkbox"/>	29	GE29

Item	Description
IP Version	IP Version <ul style="list-style-type: none"> ● IPv4 ● IPv6
Entry	Display the port number.
Port	Display the current port.
Profile ID	Display the current filter profile ID.

Click "**Add**" or "**Edit**" button to view Add/Edit Filtering Binding menu.

Edit Filtering Binding

Port	GE1
IP Version	IPv4
Profile ID	<input type="checkbox"/> Enable
	▼

Apply Close

Item	Description
Port	Display the current port.
IP Version	IP Version <ul style="list-style-type: none">● IPv4● IPv6
Profile ID	Enable/Disable Profile ID.

IV-9-2. IGMP Snooping

Use the IGMP Snooping pages to configure settings of IGMP snooping function.

IV-9-2-1. Property

This page allow user to configure global settings of IGMP snooping and configure specific VLAN settings of IGMP Snooping.

To display IGMP Snooping global setting and VLAN Setting web page, click **Multicast > IGMP Snooping > Property**.

State	<input checked="" type="checkbox"/> Enable
Version	<input checked="" type="radio"/> IGMPv2 <input type="radio"/> IGMPv3
Report Suppression	<input checked="" type="checkbox"/> Enable

Apply

VLAN Setting Table

VLAN	Operational Status	Router Port Auto Learn	Query Robustness	Query Interval	Query Max Response Interval	Last Member Query Counter	Last Member Query Interval	Immediate Leave
1	Disabled	Enabled	2	125	10	2	1	Disabled

Edit

Item	Description
State	Set the enabling status of IGMP Snooping functionality Enable: If Checked Enable IGMP Snooping, else is Disabled IGMP Snooping.
Version	Set the igmp snooping version <ul style="list-style-type: none"> ● IGMPv2: Only support process igmp v2 packet. ● IGMPv3: Support v3 basic and v2.
Report Suppression	Set the enabling status of IGMP v2 report suppression Enable: If Checked Enable IGMP Snooping v2 report suppression, else Disable the report suppression function.
VLAN	The IGMP entry VLAN ID.
Operation Status	The enable status of IGMP snooping VLAN functionality.
Router Port Auto Learn	The enabling status of IGMP snooping router port auto learning.
Query Robustness	The Query Robustness allows tuning for the expected packet loss on a subnet.
Query Interval	The interval of querier to send general query.
Query Max Response Interval	In Membership Query Messages, it specifies the maximum allowed time before sending a responding report in units of 1/10 second.
Last Member Query count	The count that Querier-switch sends Group-Specific Queries when it receives a Leave Group message for a group.
Last Member Query Interval	The interval that Querier-switch sends Group-Specific Queries when it receives a Leave Group message for a group.
Immediate leave	The immediate leave status of the group will immediate leave when receive IGMP Leave message.

Click "Edit" button to Edit VLAN Setting menu.

Edit VLAN Setting

VLAN	1
State	<input type="checkbox"/> Enable
Router Port Auto Learn	<input checked="" type="checkbox"/> Enable
Immediate leave	<input type="checkbox"/> Enable
Query Robustness	<input type="text" value="2"/> (1 - 7, default 2)
Query Interval	<input type="text" value="125"/> Sec (30 - 18000, default 125)
Query Max Response Interval	<input type="text" value="10"/> Sec (5 - 20, default 10)
Last Member Query Counter	<input type="text" value="2"/> (1 - 7, default 2)
Last Member Query Interval	<input type="text" value="1"/> Sec (1 - 25, default 1)
Operational Status	
Status	Disabled
Query Robustness	2
Query Interval	125 (Sec)
Query Max Response Interval	10 (Sec)
Last Member Query Counter	2
Last Member Query Interval	1 (Sec)

Item	Description
VLAN	The selected VLAN List.
State	Set the enabling status of IGMP Snooping VLAN functionality Enable: If Checked Enable IGMP Snooping VLAN, else is Disabled IGMP Snooping VLAN.
Router Port Auto Learn	Set the enabling status of IGMP Snooping router port learning Enable: If checked Enable learning router port by query and PIM, DVRMP, else Disable the learning router port.
Immediate leave	Immediate Leave the group when receive IGMP Leave message. Enable: If checked Enable immediate leave, else disable

	immediate leave.
Query Robustness	The Admin Query Robustness allows tuning for the expected packet loss on a subnet.
Query Interval	The Admin interval of querier to send general query.
Query Max Response Interval	The Admin query max response interval in Membership Query Messages, it specifies the maximum allowed time before sending a responding report in units of 1/10 second.
Last Member Query Counter	The Admin last member query count that Querier-switch sends Group-Specific Queries when it receives a Leave Group message for a group.
Last Member Query Interval	The Admin last member query interval that Querier-switch sends Group-Specific Queries when it receives a Leave Group message for a group.
Operational Status	
Status	Operational IGMP snooping status, must both IGMP snooping global and IGMP snooping enable the status will be enable.
Query Robustness	Operational Query Robustness.
Query Interval	Operational Query Interval.
Query Max Response Interval	Operational Query Max Response Interval
Last Member Query Counter	Operational Last Member Query Count.
Last Member Query Interval	Operational Last Member Query Interval.

IV-9-2-2. Querier

This page allow user to configure querier settings on specific VLAN of IGMP Snooping.

To display IGMP Snooping Querier Setting web page, click **Multicast > IGMP Snooping > Querier**.

Querier Table

<input type="checkbox"/>	VLAN	State	Operational Status	Version	Querier Address
<input type="checkbox"/>	1	Disabled	Disabled		

Item	Description
VLAN	IGMP Snooping querier entry VLAN ID.
State	The IGMP Snooping querier Admin State.
Operational Status	The IGMP Snooping querier operational status.
Querier	The IGMP Snooping querier operational version.
Querier IP	The operational Querier IP address on the VLAN.

Click "**Edit**" button to view Edit Querier menu.

Edit Querier

VLAN	1
State	<input type="checkbox"/> Enable
Version	<input checked="" type="radio"/> IGMPv2 <input type="radio"/> IGMPv3

Item	Description
VLAN	The Selected Edit IGMP Snooping querier VLAN List.
State	Set the enabling status of IGMP Querier Election on the chose VLANs Enabled: if checked Enable IGMP Querier else Disable IGMP Querier.
Version	Set the query version of IGMP Querier Election on the chose VLANs <ul style="list-style-type: none"> ● IGMPv2: Querier version 2. ● IGMPv3: Querier version 3. (IGMP Snooping version should be IGMPv3)

IV-9-2-3. Statistics

This page allow user to clear igmp snooping statics.

To display IGMP Snooping Statistics, click **Multicast > IGMP Snooping > Statistics**.

Receive Packet	
Total	91
Valid	8
InValid	83
Other	0
Leave	0
Report	0
General Query	0
Special Group Query	0
Source-specific Group Query	0
Transmit Packet	
Leave	0
Report	0
General Query	0
Special Group Query	0
Source-specific Group Query	0

Item	Description
Receive Packet	
Total	Total RX igmp packet, include ipv4 multicast data to CPU.
Valid	The valid igmp snooping process packet.
InValid	The invalid igmp snooping process packet.
Other	The ICMP protocol is not 2, and is not ipv4 multicast data packet.
Leave	IGMP leave packet.
Report	IGMP join and report packet.
General Query	IGMP General Query packet.
Special Group Query	IGMP Special Group General Query packet.

Source-specific Group Query	IGMP Special Source and Group General Query packet.
Transmit Packet	
Leave	IGMP leave packet
Report	IGMP join and report packet
General Query	IGMP general query packet include querier transmit general query packet.
Special Group Query	IGMP special group query packet include querier transmit special group query packet.
Source-specific Group Query	IGMP Special Source and Group General Query packet.

IV-9-3. AV Over IP

AV over IP (also known as AV/IP) refers to the use of standard network equipment to transmit and switch video and audio. AV-over-IP (Audio-Visual over Internet Protocol) is the transmission of audio, video and control signals over a network cable infrastructure for example WAN, LAN or the internet. In comparison to conventional analogue AV environments, AV over IP refers to the use of standard network equipment to switch and transmit video and audio signals. AV over IP supported high quality, low latency video distribution, reduced user costs, AV networks that are easier to create and modify, plus far more room for innovation.

IV-9-3-1. General Property

Unknown Multicast Action
 Flood
 Drop
 Forward to Router Port

Multicast Forward Method

IPv4
 DMAC-VID
 DIP-VID

IPv6
 DMAC-VID
 DIP-VID

Item	Description
Unknown Multicast	Set the unknown multicast action <ul style="list-style-type: none"> ● Flood: flood the unknown multicast data.

Action	<ul style="list-style-type: none"> ● Drop: drop the unknown multicast data. ● Forward to Router port: forward the unknown multicast data to router port.
IPv4	Set the ipv4 multicast forward method. <ul style="list-style-type: none"> ● MAC-VID: forward method dmac+vid. ● DIP-VID: forward method dip+vid.
IPv6	Set the ipv6 multicast forward method. <ul style="list-style-type: none"> ● MAC-VID: forward method dmac+vid. ● DIP-VID: forward method dip+vid(dip is ipv6 low 32 bit).

IV-9-3-2. IGMP Property

This page allow user to configure global settings of AV Over IP IGMP and configure specific VLAN settings of AV Over IP IGM.

State	<input checked="" type="checkbox"/> Enable
Version	<input checked="" type="radio"/> IGMPv2 <input type="radio"/> IGMPv3
Report Suppression	<input checked="" type="checkbox"/> Enable

Item	Description
State	Set the enabling status of IGMP Property functionality Enable: If Checked Enable IGMP Property, else is Disabled IGMP Snooping.
Version	Set the igmp snooping version <ul style="list-style-type: none"> ● IGMPv2: Only support process igmp v2 packet. ● IGMPv3: Support v3 basic and v2.
Report Suppression	Set the enabling status of IGMP v2 report suppression Enable: If Checked Enable IGMP Snooping v2 report suppression, else Disable the report suppression function.

VLAN Setting Table

VLAN	Operational Status	Router Port Auto Learn	Query Robustness	Query Interval	Query Max Response Interval	Last Member Query Counter	Last Member Query Interval	Immediate Leave
1	Enabled	Enabled	2	125	10	2	1	Enabled

Click "Add" or "Edit" button to view Add/Edit VLAN Setting menu.

Edit VLAN Setting

VLAN	1	
State	<input checked="" type="checkbox"/> Enable	
Router Port Auto Learn	<input checked="" type="checkbox"/> Enable	
Immediate leave	<input checked="" type="checkbox"/> Enable	
Query Robustness	<input type="text" value="2"/>	(1 - 7, default 2)
Query Interval	<input type="text" value="125"/>	Sec (30 - 18000, default 125)
Query Max Response Interval	<input type="text" value="10"/>	Sec (5 - 20, default 10)
Last Member Query Counter	<input type="text" value="2"/>	(1 - 7, default 2)
Last Member Query Interval	<input type="text" value="1"/>	Sec (1 - 25, default 1)
Operational Status		
Status	Enabled	
Query Robustness	2	
Query Interval	125 (Sec)	
Query Max Response Interval	10 (Sec)	
Last Member Query Counter	2	
Last Member Query Interval	1 (Sec)	

Item	Description
VLAN	The selected VLAN List.
State	Set the enabling status of IGMP Snooping VLAN functionality Enable: If Checked Enable IGMP Snooping VLAN, else is Disabled IGMP Snooping VLAN.
Router Port Auto Learn	Set the enabling status of IGMP Snooping router port learning Enable: If checked Enable learning router port by query and PIM, DVRMP, else Disable the learning router port.
Immediate leave	Immediate Leave the group when receive IGMP Leave message. Enable: If checked Enable immediate leave, else disable immediate leave.
Query Robustness	The Admin Query Robustness allows tuning for the expected packet loss on a subnet.
Query Interval	The Admin interval of querier to send general query.

Query Max Response Interval	The Admin query max response interval , In Membership Query Messages, it specifies the maximum allowed time before sending a responding report in units of 1/10 second.
Last Member Query Counter	The Admin last member query count that Querier-switch sends Group-Specific Queries when it receives a Leave Group message for a group.
Last Member Query Interval	The Admin last member query interval that Querier-switch sends Group-Specific Queries when it receives a Leave Group message for a group.
Operational Status	
Status	Operational IGMP snooping status , must both IGMP snooping global and IGMP snooping enable the status will be enable.
Query Robustness	Operational Query Robustness.
Query Interval	Operational Query Interval.
Query Max Response Interval	Operational Query Max Response Interval
Last Member Query Counter	Operational Last Member Query Count.
Last Member Query Interval	Operational Last Member Query Interval.

IV-9-3-3. Querier

This page provides IGMP Querier of AC Over IP Setting.

Querier Table

VLAN	State	Operational Status	Version	Querier Address
<input type="checkbox"/> 1	Disabled	Disabled		

Item	Description
VLAN	IGMP Snooping querier entry VLAN ID.
State	The IGMP Snooping querier Admin State.
Operational Status	The IGMP Snooping querier operational status.
Querier Version	The IGMP Snooping querier operational version.
Querier IP	The operational Querier IP address on the VLAN.

Click “**Edit**” button to edit parameter.

Edit Querier

VLAN	1
State	<input type="checkbox"/> Enable
Version	<input checked="" type="radio"/> IGMPv2 <input type="radio"/> IGMPv3

Item	Description
VLAN	The Selected Edit IGMP Snooping querier VLAN List.
State	Set the enabling status of IGMP Querier Election on the chose VLANs Enabled: if checked Enable IGMP Querier else Disable IGMP Querier.
Version	Set the query version of IGMP Querier Election on the chose VLANs <ul style="list-style-type: none"> ● IGMPv2: Querier version 2. ● IGMPv3: Querier version 3. (IGMP Snooping version should be IGMPv3)

IV-9-3-4. Statistics

Receive Packet	
Total	99
Valid	20
InValid	79
Other	0
Leave	0
Report	20
General Query	0
Special Group Query	0
Source-specific Group Query	0

Transmit Packet	
Leave	0
Report	0
General Query	0
Special Group Query	0
Source-specific Group Query	0

Clear

Refresh

IV-9-4. MLD Snooping

This page provides MLD Snooping related configuration. Most of the settings are global, whereas the Router Port configuration is related to the current unit, as reflected by the page header.

IV-9-4-1. Property

State	<input type="checkbox"/> Enable
Version	<input checked="" type="radio"/> MLDv1 <input type="radio"/> MLDv2
Report Suppression	<input checked="" type="checkbox"/> Enable

Apply

Item	Description
State	Set the enabling status of MLD Snooping functionality Enable: If Checked Enable MLD Snooping, else is Disabled MLD Snooping.
Version	Set the MLD Snooping version <ul style="list-style-type: none"> ● IGMPv2: Only support process igmp v2 packet. ● IGMPv3: Support v3 basic and v2.
Report Suppression	Limits the membership report traffic sent to multicast-capable routers. When you disable report suppression, all MLD reports are sent as is to multicast-capable routers.

VLAN Setting Table

<input type="checkbox"/>	VLAN	Operational Status	Router Port Auto Learn	Query Robustness	Query Interval	Query Max Response Interval	Last Member Query Counter	Last Member Query Interval	Immediate Leave
<input type="checkbox"/>	1	Disabled	Enabled	2	125	10	2	1	Disabled

Item	Description
VLAN	Display the current entry number
Operational Status	Display the current MLD snooping operation status
Router Port Auto Learn	Display the current router ports auto learning
Query Robustness	Display the current query robustness
Query Interval	Display the current query interval
Query Max Response Interval	Display the current query max response interval
Last Member Query Counter	Display the current last member query count
Last Member Query Interval	Display the current last member query interval
Immediate Leave	Display the current immediate leave

Click “**Edit**” button to edit parameter.

Edit VLAN Setting

VLAN	1
State	<input type="checkbox"/> Enable
Router Port Auto Learn	<input checked="" type="checkbox"/> Enable
Immediate leave	<input type="checkbox"/> Enable
Query Robustness	<input type="text" value="2"/> (1 - 7, default 2)
Query Interval	<input type="text" value="125"/> Sec (30 - 18000, default 125)
Query Max Response Interval	<input type="text" value="10"/> Sec (5 - 20, default 10)
Last Member Query Counter	<input type="text" value="2"/> (1 - 7, default 2)
Last Member Query Interval	<input type="text" value="1"/> Sec (1 - 25, default 1)
Operational Status	
Status	Disabled
Query Robustness	2
Query Interval	125 (Sec)
Query Max Response Interval	10 (Sec)
Last Member Query Counter	2
Last Member Query Interval	1 (Sec)

Item	Description
VLAN	The selected VLAN List.
State	Set the enabling status of MLD Snooping VLAN functionality Enable: If Checked Enable MLD Snooping VLAN, else is Disabled MLD Snooping VLAN.
Router Port Auto Learn	Set the enabling status of MLD Snooping router port learning Enable: If checked Enable learning router port by query and PIM, DVRMP, else Disable the learning router port.
Immediate leave	Immediate Leave the group when receive MLD Leave message. Enable: If checked Enable immediate leave, else disable immediate leave.
Query Robustness	The Admin Query Robustness allows tuning for the expected packet loss on a subnet.
Query Interval	The Admin interval of querier to send general query.
Query Max	The Admin query max response interval , In Membership

Response Interval	Query Messages, it specifies the maximum allowed time before sending a responding report in units of 1/10 second.
Last Member Query Counter	The Admin last member query count that Querier-switch sends Group-Specific Queries when it receives a Leave Group message for a group.
Last Member Query Interval	The Admin last member query interval that Querier-switch sends Group-Specific Queries when it receives a Leave Group message for a group.
Operational Status	
Status	Operational MLD snooping status , must both MLD snooping global and IGMP snooping enable the status will be enable.
Query Robustness	Operational Query Robustness.
Query Interval	Operational Query Interval.
Query Max Response Interval	Operational Query Max Response Interval
Last Member Query Counter	Operational Last Member Query Count.
Last Member Query Interval	Operational Last Member Query Interval.

IV-9-4-2. Statistics

Receive Packet	
Total	0
Valid	0
InValid	0
Other	0
Leave	0
Report	0
General Query	0
Special Group Query	0
Source-specific Group Query	0

Transmit Packet	
Leave	0
Report	0
General Query	0
Special Group Query	0
Source-specific Group Query	0

IV-9-5. MVR

Use the MVR pages to configure settings of MVR function.

IV-9-5-1. Property

To display multicast MVR property Setting web page, click **Multicast > MVR > Property**.

State	<input type="checkbox"/> Enable
VLAN	1 ▾
Mode	<input checked="" type="radio"/> Compatible <input type="radio"/> Dynamic
Group Start	0.0.0.0
Group Count	1 (1 - 128)
Query Time	1 Sec (1 - 10)
Operational Group	
Maximum	128
Current	0

Apply

Item	Description
State	Enable: if checked enable the MVR state, else disable the MVR state.
VLAN	The MVR VLAN ID.
Mode	Set the MVR mode <ul style="list-style-type: none"> ● Compatible: compatible mode. ● Dynamic: learn group member on source port.
Group Start	MVR group range start.
Group Count	MVR group continue count.
Query Time	MVR query time when receive MVR leave MVR group packet.
Maximum	The max number of MVR group database.
Current	The learned MVR group current time

IV-9-5-2. Port Setting

This page allow user to configure port role and port immediate leave.

To display MVR port role and immediate leave state setting web page, click **Multicast > MVR > Port Setting**.

Entry	Port	Role	Immediate Leave
1	GE1	None	Disabled
2	GE2	None	Disabled
3	GE3	None	Disabled
4	GE4	None	Disabled
5	GE5	None	Disabled
6	GE6	None	Disabled
7	GE7	None	Disabled
8	GE8	None	Disabled
9	GE9	None	Disabled
10	GE10	None	Disabled
11	GE11	None	Disabled
12	GE12	None	Disabled
13	GE13	None	Disabled
14	GE14	None	Disabled
15	GE15	None	Disabled
16	GE16	None	Disabled
17	GE17	None	Disabled
18	GE18	None	Disabled
19	GE19	None	Disabled
20	GE20	None	Disabled
21	GE21	None	Disabled
22	GE22	None	Disabled
23	GE23	None	Disabled
24	GE24	None	Disabled
25	XGE1	None	Disabled
26	XGE2	None	Disabled
27	XGE3	None	Disabled
28	XGE4	None	Disabled
29	LAG1	None	Disabled
30	LAG2	None	Disabled
31	LAG3	None	Disabled
32	LAG4	None	Disabled
33	LAG5	None	Disabled
34	LAG6	None	Disabled
35	LAG7	None	Disabled
36	LAG8	None	Disabled

Item	Description
Entry	Entry of number.
Port	Port Name.
Role	Port Role for MVR, the type is None/Receiver/Source.
Immediate Leave	Status of immediate leave.

Click "Edit" button to view Edit Port Setting menu.

Edit Port Setting

Port

GE1

Role

None
 Receiver
 Source

Immediate Leave

Enable

Item	Description
Port	Display the selected port list.
Role	MVR port role <ul style="list-style-type: none"> ● None: port role is none. ● Receiver: port role is receiver. ● Source: port role is source.
Immediate Leave	MVR Port immediate leave Enable: if checked is enable immediate leave, else disable immediate leave.

IV-9-5-3. Group Address

This page allow user to browse all multicast MVR groups that dynamic learned or statically added.

To display Multicast MVR Group web page, click **Multicast > MVR > Group Address**.

Group Address Table

Showing entries Showing 0 to 0 of 0 entries

<input type="checkbox"/>	VLAN	Group Address	Member	Type	Life (Sec)
0 results found.					

Item	Description
VLAN	The VLAN ID of MVR group.
Group Address	The MVR group IP address.
Member	The member ports of MVR group.
Type	The type of MVR group. Static or Dynamic.
Life(Sec)	The life time of this dynamic MVR group.

Click "**Add**" button to view Add/Edit Group Address Table menu.

Add Group Address

VLAN

Group Address (0.0.0.0 - 0.0.0.0)

Member

Available Port		Selected Port
<input style="width: 100%; height: 100px;" type="text"/>	<input type="button" value=">"/> <input type="button" value="<"/>	<input style="width: 100%; height: 100px;" type="text"/>

Item	Description
VLAN	The VLAN ID of MVR group.
Group Address	The MVR group IP address.
Member	<p>The member ports of MVR group.</p> <ul style="list-style-type: none"> ● Available Port: Optional port member, it is only receiver port when MVR mode is compatible, it include source port when mode is dynamic. ● Selected Port: Selected port member

IV-10. Security

Use the Security pages to configure settings for the switch security features.

IV-10-1. RADIUS

This page allow user to add, edit or delete RADIUS server settings and modify default parameter of RADIUS server.

To display RADIUS web page, click **Security > RADIUS**.

Use Default Parameter

Retry	<input type="text" value="3"/>	(1 - 10, default 3)
Timeout	<input type="text" value="3"/>	Sec (1 - 30, default 3)
Key String	<input type="text"/>	

RADIUS Table

Showing All entries

Showing 0 to 0 of 0 entries

	Server Address	Server Port	Priority	Retry	Timeout	Usage
0 results found.						

1

Item	Description
Retry	Set default retry number.
Timeout	Set default timeout value.
Key String	Set default RADIUS key string
RADIUS Table	
Server Address	RADIUS server address.
Server Port	RADIUS server port.
Priority	RADIUS server priority (smaller value has higher priority). RADIUS session will try to establish with the server setting which has highest priority. If failed, it will try to connect to the server with next higher priority.
Retry	RADIUS server retry value. If it is fail to connect to server, it will keep trying until timeout with retry times.
Timeout	RADIUS server timeout value. If it is fail to connect to server, it will keep trying until timeout.
Usage	RADIUS server usage type Login: For login authentication. 802.1x: For 802.1x authentication. All: For all types.

Click "**Add**" or "**Edit**" button to view Add/Edit RADIUS Server menu.

Add RADIUS Server

Address Type	<input checked="" type="radio"/> Hostname <input type="radio"/> IPv4 <input type="radio"/> IPv6
Server Address	<input type="text"/>
Server Port	<input type="text" value="1812"/> (0 - 65535, default 1812)
Priority	<input type="text"/> (0 - 65535)
Key String	<input checked="" type="checkbox"/> Use Default <input type="text"/>
Retry	<input checked="" type="checkbox"/> Use Default <input type="text" value="3"/> (1 - 10, default 3)
Timeout	<input checked="" type="checkbox"/> Use Default <input type="text" value="3"/> Sec (1 - 30, default 3)
Usage	<input type="radio"/> Login <input type="radio"/> 802.1X <input checked="" type="radio"/> All

Apply

Close

Edit RADIUS Server

Server Address	undefined
Server Port	<input type="text" value="0"/> (0 - 65535, default 1812)
Priority	<input type="text" value="-1"/> (0 - 65535)
Key String	<input type="checkbox"/> Use Default <input type="text"/>
Retry	<input type="checkbox"/> Use Default <input type="text" value="0"/> (1 - 10, default 3)
Timeout	<input type="checkbox"/> Use Default <input type="text" value="0"/> Sec (1 - 30, default 3)
Usage	<input checked="" type="radio"/> Login <input type="radio"/> 802.1X <input type="radio"/> All

Apply

Close

Item	Description
Address Type	In add dialog, user need to specify server Address Type <ul style="list-style-type: none"> ● Hostname: Use domain name as server address. ● IPv4: Use IPv4 as server address. ● IPv6: Use IPv6 as server address.
Server Address	In add dialog, user need to input server address based on address type. In edit dialog, it shows current edit server address.
Server Port	Set RADIUS server port.
Priority	Set RADIUS server priority (smaller value has higher priority). RADIUS session will try to establish with the server setting which has highest priority. If failed, it will try to connect to the server with next higher priority.
Retry	Set RADIUS server retry value. If it is fail to connect to server, it will keep trying until timeout with retry times.
Timeout	Set RADIUS server timeout value. If it is fail to connect to server, it will keep trying until timeout.
Usage	Set RADIUS server usage type <ul style="list-style-type: none"> ● Login: For login authentication. ● 802.1x: For 802.1x authentication. ● All: For all types.

IV-10-2. TACACS+

This page is to configure the RADIUS server connection session parameters.

Use Default Parameter

Timeout Sec (1 - 30, default 5)

Key String

Item	Description
Timeout	Set the timeout in the range 1 to 30, a TACACS+ request is retransmitted to a server that is not responding. If the server has not responded after the last retransmit it is considered to be dead.
Key String	Define the key between the TACACS+ server and the switch.

TACACS+ Table

Showing All entries

Showing 0 to 0 of 0 entries

Q

Server Address	Server Port	Priority	Timeout
0 results found.			

Click "Add" or "Edit" button to view Add/Edit TACACS+ Server menu.

Add TACACS+ Server

Address Type	<input checked="" type="radio"/> Hostname <input type="radio"/> IPv4 <input type="radio"/> IPv6
Server Address	<input type="text"/>
Server Port	<input type="text" value="49"/> (0 - 65535, default 49)
Priority	<input type="text"/> (0 - 65535)
Key String	<input checked="" type="checkbox"/> Use Default <input type="text"/>
Timeout	<input checked="" type="checkbox"/> Use Default <input type="text" value="5"/> Sec (1 - 30, default 5)

Item	Description
Address Type	In add dialog, user need to specify server Address Type <ul style="list-style-type: none"> ● Hostname: Use domain name as server address. ● IPv4: Use IPv4 as server address. ● IPv6: Use IPv6 as server address.
Server Address	In add dialog, user need to input server address based on address type. In edit dialog, it shows current edit server address.
Server Port	Set RADIUS server port.
Priority	Set RADIUS server priority (smaller value has higher priority). RADIUS session will try to establish with the server setting which has highest priority. If failed, it will try to connect to the server with next higher priority.
Retry	Set RADIUS server retry value. If it is fail to connect to server, it will keep trying until timeout with retry times.
Key String	Set the key- shared between the TACACS+ Authentication

	Server and the switch.
Timeout	Set RADIUS server timeout value. If it is fail to connect to server, it will keep trying until timeout.

IV-10-3. Method List

Indicates the host can define different methods from Empty/None/Local/Enable/RADIUS/TACACS+.

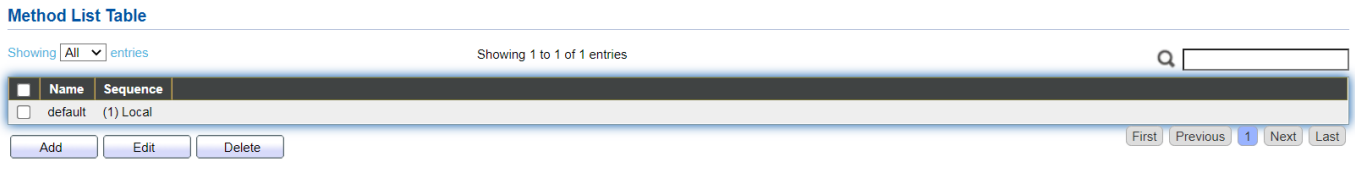

Click "Add" or "Edit" button to view Add/Edit Method List.

Add Method List

Name

Method 1

- Empty
- None
- Local
- Enable
- RADIUS
- TACACS+

Method 2

- Empty
- None
- Local
- Enable
- RADIUS
- TACACS+

Method 3

- Empty
- None
- Local
- Enable
- RADIUS
- TACACS+

Method 4

- Empty
- None
- Local
- Enable
- RADIUS
- TACACS+

Apply

Close

IV-10-4. Login Authentication

This section is to control the access of the Managed Switch, including the different access methods – Console, Telnet, SSH, HTTP and HTTPS.

Console	default	(1) Local
Telnet	default	(1) Local
SSH	default	(1) Local
HTTP	default	(1) Local
HTTPS	default	(1) Local

Apply

IV-10-5. Management Access

Use the Management Access pages to configure settings of management access.

IV-10-5-1. Management VLAN

Management VLAN	1 - default
-----------------	-------------

Note: Change Management VLAN may cause connection interrupted

Apply

Note: Change Management VLAN may cause connection interrupted

IV-10-5-2. Management Service

This page allow user to change management services related configurations.

To display Management Service click **Security > Management Access > Management Service**.

Management Service		
Telnet	<input type="checkbox"/>	Enable
SSH	<input type="checkbox"/>	Enable
HTTP	<input checked="" type="checkbox"/>	Enable
HTTPS	<input type="checkbox"/>	Enable
SNMP	<input checked="" type="checkbox"/>	Enable
Session Timeout		
Console	<input type="text" value="10"/>	Min (0 - 65535, default 10)
Telnet	<input type="text" value="10"/>	Min (0 - 65535, default 10)
SSH	<input type="text" value="10"/>	Min (0 - 65535, default 10)
HTTP	<input type="text" value="10"/>	Min (0 - 65535, default 10)
HTTPS	<input type="text" value="10"/>	Min (0 - 65535, default 10)
Password Retry Count		
Console	<input type="text" value="3"/>	(0 - 120, default 3)
Telnet	<input type="text" value="3"/>	(0 - 120, default 3)
SSH	<input type="text" value="3"/>	(0 - 120, default 3)
Silent Time		
Console	<input type="text" value="0"/>	Sec (0 - 65535, default 0)
Telnet	<input type="text" value="0"/>	Sec (0 - 65535, default 0)
SSH	<input type="text" value="0"/>	Sec (0 - 65535, default 0)

Apply

Item	Description
Management Service	Management service admin state. <ul style="list-style-type: none"> ● Telnet: Connect CLI through telnet. ● SSH: Connect CLI through SSH. ● HTTP: Connect WEBUI through HTTP. ● HTTPS: Connect WEBUI through HTTPS. ● SNMP: Manage switch trough SNMP.
Session Timeout	Set session timeout minutes for user access to user interface. 0 minutes means never timeout.
Password	Retry count is the number which CLI password input error

Retry Count	tolerance count. After input error password exceeds this count, the CLI will freeze after silent time.
Silent Time	After input error password exceeds password retry count, the CLI will freeze after silent time.

IV-10-5-3. Management ACL

This page allow user to add or delete management ACL rule. A rule cannot be deleted if under active.

To display Management ACL page, click **Security > Management Access > Management ACL**.

ACL Name

Management ACL Table

Showing All ▼ entries
Showing 0 to 0 of 0 entries

☐	ACL Name	State	Rule
0 results found.			

First
Previous
1
Next
Last

Item	Description
ACL Name	Input MAC ACL name.
Management ACL	
ACL Name	Display Management ACL name.
State	Display Management ACL whether active.
Rule	Display the number Management ACE rule of ACL.

IV-10-5-4. Management ACE

This page allow user to add, edit or delete ACE rule. An ACE rule cannot be edited or deleted if ACL under active. New ACE cannot be added if ACL under active

To display Management ACE page, click **Security > Management Access > Management ACE**.

Management ACE Table

ACL Name

Showing entries

Showing 0 to 0 of 0 entries

<input type="checkbox"/>	Priority	Action	Service	Port	Address / Mask
0 results found.					

Item	Description
ACL Name	Select the ACL name to which an ACE is being added.
Priority	Display the priority of ACE.
Action	Display the action of ACE.
Service	Display the service ACE
Port	Display the port list of ACE
Address / Mask	Display the source IP address and mask of ACE.

Click "**Add**" or "**Edit**" button to view Add/Edit Management ACE menu.

Add Management ACE

ACL Name	manage	
Priority	1 (1 - 65535)	
Service	<input type="radio"/> All <input type="radio"/> Http <input type="radio"/> Https <input checked="" type="radio"/> Snmp <input type="radio"/> SSH <input type="radio"/> Telnet	
Action	<input type="radio"/> Permit <input checked="" type="radio"/> Deny	
Port	Available Port	Selected Port
	GE1 GE2 GE3 GE4 GE5 GE6 GE7 GE8	
IP Version	<input checked="" type="radio"/> All <input type="radio"/> IPv4 <input type="radio"/> IPv6	
IPv4	/ 255.255.255.255	
IPv6	/ 128 (1 - 128)	

Apply

Close

Edit Management ACE

ACL Name	manage	
Priority	1	
Service	<input type="radio"/> All <input type="radio"/> Http <input type="radio"/> Https <input checked="" type="radio"/> Snmp <input type="radio"/> SSH <input type="radio"/> Telnet	
Action	<input type="radio"/> Permit <input checked="" type="radio"/> Deny	
Port	Available Port GE2 GE3 GE4 GE5 GE6 GE7 GE8 GE9	Selected Port GE1
IP Version	<input checked="" type="radio"/> All <input type="radio"/> IPv4 <input type="radio"/> IPv6	
IPv4	/ 255.255.255.255	
IPv6	/ 128 (1 - 128)	

Apply

Close

Item	Description
ACL Name	Display the ACL name to which an ACE is being added.
Priority	Specify the priority of the ACE. ACEs with higher sequence are processed first (1 is the highest priority). Only available on Add Dialog.
Service	Select the type service of rule. <ul style="list-style-type: none"> ● All: All services. ● HTTP: Only HTTP service. ● HTTPS: Only HTTPS service ● SNMP: Only SNMP service. ● SSH: Only SSH service. ● Telnet: Only Telnet service
Action	Select the action after ACE match packet. <ul style="list-style-type: none"> ● Permit: Forward packets that meet the ACE criteria. ● Deny: Drop packets that meet the ACE criteria.

Port	Select ports which will be matched.
IP Version	Select the type of source IP address. <ul style="list-style-type: none"> ● All: All IP addresses can access. ● IPv4: Specify IPv4 address ca access. ● IPv6: Specify IPv6 address ca access.
IPv4	Enter the source IPv4 address value and mask to which will be matched.
IPv6	Enter the source IPv6 address value and mask to which will be matched.

IV-10-6. Authentication Manager

IV-10-6-1. Property

This page allow user to edit authentication global settings and some port mods' configurations.

To display authentication manager Property web page, click **Security > Authentication Manager > Property**.

Authentication Type	<input checked="" type="checkbox"/> 802.1x
Guest VLAN	<input type="checkbox"/> Enable
MAC-Based User ID Format	<input type="text" value="1"/> <input type="text" value="XXXXXXXXXXXX"/>

Entry	Port	Authentication Type 802.1x	Host Mode	Method	Guest VLAN	VLAN Assign Mode	
<input type="checkbox"/>	1	GE1	Disabled	Multiple Authentication	RADIUS	Disabled	Static
<input type="checkbox"/>	2	GE2	Disabled	Multiple Authentication	RADIUS	Disabled	Static
<input type="checkbox"/>	3	GE3	Disabled	Multiple Authentication	RADIUS	Disabled	Static
<input type="checkbox"/>	4	GE4	Disabled	Multiple Authentication	RADIUS	Disabled	Static
<input type="checkbox"/>	5	GE5	Disabled	Multiple Authentication	RADIUS	Disabled	Static
<input type="checkbox"/>	6	GE6	Disabled	Multiple Authentication	RADIUS	Disabled	Static
<input type="checkbox"/>	7	GE7	Disabled	Multiple Authentication	RADIUS	Disabled	Static
<input type="checkbox"/>	8	GE8	Disabled	Multiple Authentication	RADIUS	Disabled	Static
<input type="checkbox"/>	9	GE9	Disabled	Multiple Authentication	RADIUS	Disabled	Static
<input type="checkbox"/>	10	GE10	Disabled	Multiple Authentication	RADIUS	Disabled	Static
<input type="checkbox"/>	11	GE11	Disabled	Multiple Authentication	RADIUS	Disabled	Static
<input type="checkbox"/>	12	GE12	Disabled	Multiple Authentication	RADIUS	Disabled	Static
<input type="checkbox"/>	13	GE13	Disabled	Multiple Authentication	RADIUS	Disabled	Static
<input type="checkbox"/>	14	GE14	Disabled	Multiple Authentication	RADIUS	Disabled	Static
<input type="checkbox"/>	15	GE15	Disabled	Multiple Authentication	RADIUS	Disabled	Static
<input type="checkbox"/>	16	GE16	Disabled	Multiple Authentication	RADIUS	Disabled	Static
<input type="checkbox"/>	17	GE17	Disabled	Multiple Authentication	RADIUS	Disabled	Static
<input type="checkbox"/>	18	GE18	Disabled	Multiple Authentication	RADIUS	Disabled	Static
<input type="checkbox"/>	19	GE19	Disabled	Multiple Authentication	RADIUS	Disabled	Static
<input type="checkbox"/>	20	GE20	Enabled	Multiple Authentication	RADIUS	Disabled	Static
<input type="checkbox"/>	21	GE21	Disabled	Multiple Authentication	RADIUS	Disabled	Static
<input type="checkbox"/>	22	GE22	Disabled	Multiple Authentication	RADIUS	Disabled	Static
<input type="checkbox"/>	23	GE23	Disabled	Multiple Authentication	RADIUS	Disabled	Static
<input type="checkbox"/>	24	GE24	Disabled	Multiple Authentication	RADIUS	Disabled	Static
<input type="checkbox"/>	25	XGE1	Disabled	Multiple Authentication	RADIUS	Disabled	Static
<input type="checkbox"/>	26	XGE2	Disabled	Multiple Authentication	RADIUS	Disabled	Static
<input type="checkbox"/>	27	XGE3	Disabled	Multiple Authentication	RADIUS	Disabled	Static
<input type="checkbox"/>	28	XGE4	Disabled	Multiple Authentication	RADIUS	Disabled	Static

Item	Description
Authentication Type	<p>Set checkbox to enable/disable following authentication types</p> <ul style="list-style-type: none"> ● 802.1x: Use IEEE 802.1x to do authentication ● MAC-Based: Use MAC address to do authentication ● WEB-Based: Prompt authentication web page for user to do authentication
Guest VLAN	<p>Set checkbox to enable/disable guest VLAN, if guest VLAN is enabled, you need to select one available VLAN ID to be guest VID.</p>
MAC-Based User ID Format	<p>Select mac-based authentication RADIUS username/password ID format.</p> <ul style="list-style-type: none"> ● XXXXXXXXXXXXX ● Xxxxxxxxxxxxxx ● XX:XX:XX:XX:XX:XX ● xx:xx:xx:xx:xx:xx ● XX-XX-XX-XX-XX-XX ● xx-xx-xx-xx-xx-xx ● XX.XX.XX.XX.XX.XX ● xx.xx.xx.xx.xx.xx ● XXXX:XXXX:XXXX ● xxxx:xxxx:xxxx ● XXXX-XXXX-XXXX ● XXXX-XXXX-XXXX ● XXXX.XXXX.XXXX ● XXXX.XXXX.XXXX ● XXXXXX:XXXXXX ● XXXXXX:XXXXXX ● XXXXXX-XXXXXX

	<ul style="list-style-type: none"> ● XXXXXX-XXXXXX
Port Mode Table	
Port	Port Name.
Authentication Type (802.1X)	802.1X authentication type state <ul style="list-style-type: none"> ● Enabled: 802.1X is enabled. ● Disabled: 802.1X is disabled.
Authentication Type (MAC-Based)	MAC-Based authentication type state <ul style="list-style-type: none"> ● Enabled: MAC-Based authentication is enabled ● Disabled: MAC-Based authentication is disabled
Authentication Type (WEB-Based)	WEB-Based authentication type state <ul style="list-style-type: none"> ● Enabled: WEB-Based authentication is enabled ● Disabled: WEB-Based authentication is disabled
Host Mode	Authenticating host mode <ul style="list-style-type: none"> ● Multiple Authentication: In this mode, every client need to pass authenticate procedure individually. ● Multiple Hosts: In this mode, only one client need to be authenticated and other clients will get the same access accessibility. Web-auth cannot be enabled in this mode. ● Single Host: In this mode, only one host is allowed to be authenticated. It is the same as Multi-auth mode with max hosts number configure to be 1.
Order	Support following authentication type order combinations. Web Authentication should always be the last type. The authentication manager will go to next type if current type is not enabled or authenticated fail. <ul style="list-style-type: none"> ● 802.1x ● MAC-Based ● WEB-Based ● 802.1x MAC-Based ● 802.1x WEB-Based ● MAC-Based 802.1x ● WEB-Based 802.1x ● 802.1x MAC-Based WEB-Based ● 802.1x WEB-Based MAC-Based
Method	Support following authentication method order combinations. These orders only available on MAC-Based authentication and WEB-Based authentication. 802.1x only support Radius method. <ul style="list-style-type: none"> ● Local: Use DUT's local database to do authentication ● Radius: Use remote RADIUS server to do authentication ● Local Radius ● Radius Local
Guest VLAN	Port guest VLAN enable state

	<ul style="list-style-type: none"> ● Enabled: Guest VLAN is enabled on port. ● Disabled: Guest VLAN is disabled on port.
VLAN Assign Mode	<p>Support following VLAN assign mode and only apply when source is RADIUS</p> <ul style="list-style-type: none"> ● Disable: Ignore the VLAN authorization result and keep original VLAN of host. ● Reject: If get VLAN authorized information, just use it. However, if there is no VLAN authorized information, reject the host and make it unauthorized. ● Static: If get VLAN authorized information, just use it. If there is no VLAN authorized information, keep original VLAN of host.

Click “**Edit**” button to view the Edit Port Mode menu.

Edit Port Mode

Port	GE1	
Authentication Type	<input type="checkbox"/> 802.1x <input type="checkbox"/> MAC-Based <input type="checkbox"/> WEB-Based	
Host Mode	<input checked="" type="radio"/> Multiple Authentication <input type="radio"/> Multiple Hosts <input type="radio"/> Single Host	
Order	Available Type MAC-Based WEB-Based	Select Type 802.1x
Method	Available Method Local	Select Method RADIUS
Guest VLAN	<input type="checkbox"/> Enable <input type="radio"/> Disable	
VLAN Assign Mode	<input type="radio"/> Disable <input type="radio"/> Reject <input checked="" type="radio"/> Static	

Apply Close

Item	Description
Port	Selected port list.
Authentication Type	Set checkbox to enable/disable authentication types.
Host Mode	<p>Select authenticating host mode</p> <ul style="list-style-type: none"> ● Multiple Authentication: In this mode, every client need to pass authenticate procedure individually. ● Multiple Hosts: In this mode, only one client need to be authenticated and other clients will get the same access accessibility. Web-auth cannot be enabled in this mode. ● Single Host: In this mode, only one host is allowed to be authenticated. It is the same as Multi-auth mode with max hosts number configure to be 1.
Order	<p>Support following authentication type order combinations. Web Authentication should always be the last type. The authentication manager will go to next type if current type is not enabled or authenticated fail.</p> <ul style="list-style-type: none"> ● 802.1x ● MAC-Based ● WEB-Based ● 802.1x MAC-Based ● 802.1x WEB-Based ● MAC-Based 802.1x ● WEB-Based 802.1x ● 802.1x MAC-Based WEB-Based ● 802.1x WEB-Based MAC-Based
Method	<p>Support following authentication method order combinations. These orders only available on MAC-Based authentication and WEB-Based authentication. 802.1x only support Radius method.</p> <ul style="list-style-type: none"> ● Local: Use DUT's local database to do authentication. ● Radius: Use remote RADIUS server to do authentication. ● Local Radius. ● Radius Local.
Guest VLAN	Set checkbox to enable/disable guest VLAN.
VLAN Assign Mode	<p>Support following VLAN assign mode and only apply when source is RADIUS</p> <ul style="list-style-type: none"> ● Disable: Ignore the VLAN authorization result and keep original VLAN of host. ● Reject: If get VLAN authorized information, just use it. However, if there is no VLAN authorized information, reject the host and make it unauthorized. ● Static: If get VLAN authorized information, just use it. If

there is no VLAN authorized information, keep original VLAN of host.

IV-10-6-2. Port Setting

This page allow user to configure authentication manger port settings

To display the authentication manager Port Setting web page, click **Security > Authentication Manager > Port Setting**.

Port Setting Table

Entry	Port	Port Control	Reauthentication	Max Hosts	Common Timer				802.1x Parameters			
					Reauthentication	Inactive	Quiet	TX Period	Supplicant Timeout	Server Timeout	Max Request	
<input type="checkbox"/>	1	GE1	Disabled	Disabled	256	3600	60	60	30	30	30	2
<input type="checkbox"/>	2	GE2	Disabled	Disabled	256	3600	60	60	30	30	30	2
<input type="checkbox"/>	3	GE3	Disabled	Disabled	256	3600	60	60	30	30	30	2
<input type="checkbox"/>	4	GE4	Disabled	Disabled	256	3600	60	60	30	30	30	2
<input type="checkbox"/>	5	GE5	Disabled	Disabled	256	3600	60	60	30	30	30	2
<input type="checkbox"/>	6	GE6	Disabled	Disabled	256	3600	60	60	30	30	30	2
<input type="checkbox"/>	7	GE7	Disabled	Disabled	256	3600	60	60	30	30	30	2
<input type="checkbox"/>	8	GE8	Disabled	Disabled	256	3600	60	60	30	30	30	2
<input type="checkbox"/>	9	GE9	Disabled	Disabled	256	3600	60	60	30	30	30	2
<input type="checkbox"/>	10	GE10	Disabled	Disabled	256	3600	60	60	30	30	30	2
<input type="checkbox"/>	11	GE11	Disabled	Disabled	256	3600	60	60	30	30	30	2
<input type="checkbox"/>	12	GE12	Disabled	Disabled	256	3600	60	60	30	30	30	2
<input type="checkbox"/>	13	GE13	Disabled	Disabled	256	3600	60	60	30	30	30	2
<input type="checkbox"/>	14	GE14	Disabled	Disabled	256	3600	60	60	30	30	30	2
<input type="checkbox"/>	15	GE15	Disabled	Disabled	256	3600	60	60	30	30	30	2
<input type="checkbox"/>	16	GE16	Disabled	Disabled	256	3600	60	60	30	30	30	2
<input type="checkbox"/>	17	GE17	Disabled	Disabled	256	3600	60	60	30	30	30	2
<input type="checkbox"/>	18	GE18	Disabled	Disabled	256	3600	60	60	30	30	30	2
<input type="checkbox"/>	19	GE19	Disabled	Disabled	256	3600	60	60	30	30	30	2
<input type="checkbox"/>	20	GE20	Force Authorized	Enabled	256	3600	60	60	30	30	30	2
<input type="checkbox"/>	21	GE21	Disabled	Disabled	256	3600	60	60	30	30	30	2
<input type="checkbox"/>	22	GE22	Disabled	Disabled	256	3600	60	60	30	30	30	2
<input type="checkbox"/>	23	GE23	Disabled	Disabled	256	3600	60	60	30	30	30	2
<input type="checkbox"/>	24	GE24	Disabled	Disabled	256	3600	60	60	30	30	30	2
<input type="checkbox"/>	25	XGE1	Disabled	Disabled	256	3600	60	60	30	30	30	2
<input type="checkbox"/>	26	XGE2	Disabled	Disabled	256	3600	60	60	30	30	30	2
<input type="checkbox"/>	27	XGE3	Disabled	Disabled	256	3600	60	60	30	30	30	2
<input type="checkbox"/>	28	XGE4	Disabled	Disabled	256	3600	60	60	30	30	30	2

Edit

Item	Description
Port	Port
Port Control	<p>Support following authentication port control types.</p> <ul style="list-style-type: none"> ● Disable: Disable authentication function and all clients have network accessibility. ● Force Authorized: Port is force authorized and all clients have network accessibility. ● Force Unauthorized: Port is force unauthorized and all clients have no network accessibility. ● Auto: Need passing authentication procedure to get network accessibility.
Reauthentication	<p>Reautheticate state</p> <ul style="list-style-type: none"> ● Enabled: Host will be reauthenticated after reauthentication period. ● Disabled: Host will not be reauthenticated after reauthentication period.

Max Hosts	In Multiple Authentication mode, total host number cannot exceed max hosts number.
Common Timer (Reauthentication)	After re-authenticate period, host will return to initial state and need to pass authentication procedure again.
Common Timer (Inactive)	If no packet from the authenticated host, the inactive timer will increase. After inactive timeout, the host will be unauthorized and corresponding session will be deleted. In multi-host mode, the packet is counting on the authorized host only.
Common Timer (Quiet)	When port is in Locked state after authenticating fail several times, the host will be locked in quiet period. After this quiet period, the host is allowed to authenticate again.
802.1X Params (TX Period)	Number of seconds that the device waits for a response to an Extensible Authentication Protocol (EAP) request/identity frame from the supplicant (client) before resending the request.
802.1X Params (Supplicant Timeout)	The maximum number of EAP requests that can be sent. If a response is not received after the defined period (supplicant timeout), the authentication process is restarted.
802.1X Params (Server Timeout)	Number of seconds that lapses before EAP requests are resent to the supplicant.
802.1X Params (Max Request)	Number of seconds that lapses before the device resends a request to the authentication server.
Web-Based Param (Max Login)	Allow user login fail number. After login fail number exceed, the host will enter Lock state and is not able to authenticate until quiet period exceed.

Click "**Edit**" button to view Edit Port Setting menu.

Edit Port Setting

Port	GE1	
Port Control	<input checked="" type="radio"/> Disabled <input type="radio"/> Force Authorized <input type="radio"/> Force Unauthorized <input type="radio"/> Auto	
Reauthentication	<input type="checkbox"/> Enable	
Max Hosts	<input type="text" value="256"/>	(1 - 256, default 256)
Common Timer		
Reauthentication	<input type="text" value="3600"/>	Sec (300 - 4294967294, default 3600)
Inactive	<input type="text" value="60"/>	Sec (60 - 65535, default 60)
Quiet	<input type="text" value="60"/>	Sec (0 - 65535, default 60)
802.1x Parameters		
TX Period	<input type="text" value="30"/>	Sec (1 - 65535, default 30)
Supplicant Timeout	<input type="text" value="30"/>	Sec (1 - 65535, default 30)
Server Timeout	<input type="text" value="30"/>	Sec (1 - 65535, default 30)
Max Request	<input type="text" value="2"/>	(1 - 10, default 2)
Web-Based Parameters		
Max Login	<input type="checkbox"/> Infinite <input type="text" value="3"/>	(3 - 10, default 3)

Apply

Close

Item	Description
Port	Port Name.
Port Control	Support following authentication port control types. <ul style="list-style-type: none"> ● Disable: Disable authentication function and all clients have network accessibility. ● Force Authorized: Port is force authorized and all clients have network accessibility. ● Force Unauthorized: Port is force unauthorized and all clients have no network accessibility. ● Auto: Need passing authentication procedure to get network accessibility.
Reauthentication	Set checkbox to enable/disable reauthentication.
Max Hosts	In Multiple Authentication mode, total host number cannot not exceed max hosts number.

Common Timer	
Reauthentication	After re-authenticate period, host will return to initial state and need to pass authentication procedure again.
Inactive	If no packet from the authenticated host, the inactive timer will increase. After inactive timeout, the host will be unauthorized and corresponding session will be deleted. In multi-host mode, the packet is counting on the authorized host only and not all packets on the port.
Quiet	When port is in Locked state after authenticating fail several times, the host will be locked in quiet period. After this quiet period, the host is allowed to authenticate again.
802.1X Params	
TX Period	Number of seconds that the device waits for a response to an Extensible Authentication Protocol (EAP) request/identity frame from the supplicant (client) before resending the request.
Supplicant Timeout	The maximum number of EAP requests that can be sent. If a response is not received after the defined period (supplicant timeout), the authentication process is restarted.
Server Timeout	Number of seconds that lapses before EAP requests are resent to the supplicant.
Max Request	Number of seconds that lapses before the device resends a request to the authentication server.
Web-Based Param	
Max Login	Set checkbox to set max login number to be infinite or specify max login number.

IV-10-6-3. MAC-Base Local Account

Click "Edit" or "ADD" button to view Edit MAC-Based Local Account menu.

MAC-Based Local Account Table

Showing All entries Showing 0 to 0 of 0 entries

MAC Address	Control	VLAN	Timeout (Sec)	
			Reauthentication	Inactive
0 results found.				

Add Edit Delete First Previous 1 Next Last

Add MAC-Based Local Account

MAC Address	<input type="text"/>
Port Control	<input type="radio"/> Force Authorized <input checked="" type="radio"/> Force Unauthorized
VLAN	<input type="checkbox"/> User Defined <input type="text" value="1"/> (1 - 4094)
Assigned Timer	
Reauthentication	<input type="checkbox"/> User Defined <input type="text" value="3600"/> Sec (300 - 4294967294)
Inactive	<input type="checkbox"/> User Defined <input type="text" value="60"/> Sec (60 - 65535)

Item	Description
MAC Address	Enter the MAC Address
Port Control	Support following authentication port control types. <ul style="list-style-type: none"> ● Disable: Disable authentication function and all clients have network accessibility. ● Force Authorized: Port is force authorized and all clients have network accessibility. ● Force Unauthorized: Port is force unauthorized and all clients have no network accessibility. ● Auto: Need passing authentication procedure to get network accessibility.
VLAN	Set the VLAN (1~4094)
Assigned Timer	
Reauthentication	After re-authenticate period, host will return to initial state and need to pass authentication procedure again.
Inactive	If no packet from the authenticated host, the inactive timer will increase. After inactive timeout, the host will be unauthorized and corresponding session will be deleted. In multi-host mode, the packet is counting on the authorized host only and not all packets on the port.

IV-10-6-4. WEB-Base Local Account

WEB-Based Local Account Table

Showing All entries Showing 0 to 0 of 0 entries

	Username	VLAN	Timeout (Sec)	
			Reauthentication	Inactive
0 results found.				

Click "Edit" or "ADD" button to view Edit MAC-Based Local Account menu.

Add WEB-Based Local Account

Username	<input type="text"/>
Password	<input type="text"/>
Confirm Password	<input type="text"/>
VLAN	<input type="checkbox"/> User Defined <input type="text" value="1"/> (1 - 4094)
Assigned Timer	
Reauthentication	<input type="checkbox"/> User Defined <input type="text" value="3600"/> Sec (300 - 4294967294)
Inactive	<input type="checkbox"/> User Defined <input type="text" value="60"/> Sec (60 - 65535)

Item	Description
Username	Enter the username.
Password	Enter the password.
Confirm Password	Re-enter the password.
VLAN	Set the VLAN (1~4094)
Assigned Timer	
Reauthentication	After re-authenticate period, host will return to initial state and need to pass authentication procedure again.
Inactive	If no packet from the authenticated host, the inactive timer will increase. After inactive timeout, the host will be unauthorized and corresponding session will be deleted. In multi-host mode, the packet is counting on the authorized host only and not all packets on the port.

IV-10-6-5. Sessions

This page show all detail information of authentication sessions and allow user to select specific session to delete by clicking “Clear ” button.

To display Sessions web page, click **Security > Authentication Manger > Sessions**.

Sessions Table

Showing All entries Showing 0 to 0 of 0 entries Q

Session ID	Port	MAC Address	Current Type	Status	Operational Information			Authorized Information		
					VLAN	Session Time	Inactived Time	Quiet Time	VLAN	Reauthentication Period
0 results found.										

First Previous 1 Next Last

Clear Refresh

Item	Description
Session ID	Session ID is unique of each session.
Port	Port name which the host located.
MAC Address	Host MAC address.
Current Type	Show current authenticating type <ul style="list-style-type: none"> ● 802.1x: Use IEEE 802.1X to do authenticating ● MAC-Based: Use MAC-Based authentication to do authenticating. ● WEB-Based: Use WEB-Based authentication to do authenticating.
Status	Show host authentication session status IP version (IPv4, IPv6) <ul style="list-style-type: none"> ● Disable: This session is ready to be deleted ● Running: Authentication process is running ● Authorized: Authentication is passed and getting network accessibility. ● Unauthorized: Authentication is not passed and not getting network accessibility. ● Locked: Host is locked and do not allow to do authenticating until quiet period. ● Guest: Host is in the guest VLAN.
Operational (VLAN)	Shows host operational VLAN ID.
Operational (Session Time)	In “Authorized” state, it shows total time after authorized.
Operational (Inactived)	In “Authorized” state, it shows how long the host do not send any packet.
Operational	In “Locked” state, it shows total time after locked.

(Quiet Time)	
Authorized (VLAN)	Shows VLAN ID given from authorized procedure.
Authorized (Reauthentication Period)	Shows reauthentication period given from authorized procedure.
Authorized (Inactive Timeouts)	Shows inactive timeout given from authorized procedure.

IV-10-7. Port Security

This page allow user to configure port security settings for each interface. When port security is enabled on interface, action will be perform once learned MAC address over limitation.

To display Port Security web page, click **Security > Port Security**.

Port Security Table

Entry	Port	State	MAC Address	Action
<input type="checkbox"/>	1 GE1	Disabled	1	Discard
<input type="checkbox"/>	2 GE2	Disabled	1	Discard
<input type="checkbox"/>	3 GE3	Disabled	1	Discard
<input type="checkbox"/>	4 GE4	Disabled	1	Discard
<input type="checkbox"/>	5 GE5	Disabled	1	Discard
<input type="checkbox"/>	6 GE6	Disabled	1	Discard
<input type="checkbox"/>	7 GE7	Disabled	1	Discard
<input type="checkbox"/>	8 GE8	Disabled	1	Discard
<input type="checkbox"/>	9 GE9	Disabled	1	Discard
<input type="checkbox"/>	10 GE10	Disabled	1	Discard
<input type="checkbox"/>	11 GE11	Disabled	1	Discard
<input type="checkbox"/>	12 GE12	Disabled	1	Discard
<input type="checkbox"/>	13 GE13	Disabled	1	Discard
<input type="checkbox"/>	14 GE14	Disabled	1	Discard
<input type="checkbox"/>	15 GE15	Disabled	1	Discard
<input type="checkbox"/>	16 GE16	Disabled	1	Discard
<input type="checkbox"/>	17 GE17	Disabled	1	Discard
<input type="checkbox"/>	18 GE18	Disabled	1	Discard
<input type="checkbox"/>	19 GE19	Disabled	1	Discard
<input type="checkbox"/>	20 GE20	Disabled	1	Discard
<input type="checkbox"/>	21 GE21	Disabled	1	Discard
<input type="checkbox"/>	22 GE22	Disabled	1	Discard
<input type="checkbox"/>	23 GE23	Disabled	1	Discard
<input type="checkbox"/>	24 GE24	Disabled	1	Discard
<input type="checkbox"/>	26 XGE1	Disabled	1	Discard
<input type="checkbox"/>	26 XGE2	Disabled	1	Discard
<input type="checkbox"/>	27 XGE3	Disabled	1	Discard
<input type="checkbox"/>	28 XGE4	Disabled	1	Discard
<input type="checkbox"/>	29 LAG1	Disabled	1	Discard
<input type="checkbox"/>	30 LAG2	Disabled	1	Discard
<input type="checkbox"/>	31 LAG3	Disabled	1	Discard
<input type="checkbox"/>	32 LAG4	Disabled	1	Discard
<input type="checkbox"/>	33 LAG5	Disabled	1	Discard
<input type="checkbox"/>	34 LAG6	Disabled	1	Discard
<input type="checkbox"/>	35 LAG7	Disabled	1	Discard
<input type="checkbox"/>	36 LAG8	Disabled	1	Discard

Edit

Item	Description
State	Enable/Disable the port security function.
Port	Select one or multiple ports to configure.
State	Select the status of port security <ul style="list-style-type: none"> ● Disable: Disable port security function. ● Enable: Enable port security function.
MAC Address	Specify the number of how many mac addresses can be learned.

Action	<p>Select the action if learned mac addresses</p> <ul style="list-style-type: none"> ● Forward: Forward this packet whose SMAC is new to system and exceed the learning-limit number. ● Discard: Discard this packet whose SMAC is new to system and exceed the learning-limit number. ● Shutdown: Shutdown this port when receives a packet whose SMAC is new to system and exceed the learning limit number.
--------	---

Click "**Edit**" button to view Edit Port Security menu.

Edit Port Security

Port	GE1
State	<input type="checkbox"/> Enable
MAC Address	<input style="width: 100px;" type="text" value="1"/> (0 - 255, default 1)
Action	<input type="radio"/> Forward <input checked="" type="radio"/> Discard <input type="radio"/> Shutdown

Item	Description
Port	Select one or multiple ports to configure.
State	Select the status of port security Disable: Disable port security function. Enable: Enable port security function.
MAC Address	Specify the number of how many mac addresses can be learned.
Action	Select the action if learned mac addresses <ul style="list-style-type: none"> ● Forward: Forward this packet whose SMAC is new to system and exceed the learning-limit number. ● Discard: Discard this packet whose SMAC is new to system and exceed the learning-limit number. ● Shutdown: Shutdown this port when receives a packet whose SMAC is new to system and exceed the learning limit number.

IV-10-8. Traffic Segmentation

Traffic Segmentation prohibits ports to communicate with each other directly, on other manufacturers' switches

Traffic Segmentation Settings

Port List (e.g. GE1,GE2-5,XGE1-2)	<input type="text"/>	<input type="checkbox"/> All Ports
Forward Port List (e.g. GE1,GE2-5,XGE1-2)	<input type="text"/>	<input type="checkbox"/> All Ports

Traffic Segmentation Table

Entry	Port	Forward Port List
1	GE1	GE21-24,XGE1-4
2	GE2	GE21-24,XGE1-4
3	GE3	GE21-24,XGE1-4
4	GE4	GE21-24,XGE1-4
5	GE5	GE21-24,XGE1-4
6	GE6	GE21-24,XGE1-4
7	GE7	GE21-24,XGE1-4
8	GE8	GE21-24,XGE1-4
9	GE9	GE21-24,XGE1-4
10	GE10	GE21-24,XGE1-4
11	GE11	GE21-24,XGE1-4
12	GE12	GE21-24,XGE1-4
13	GE13	GE21-24,XGE1-4
14	GE14	GE21-24,XGE1-4
15	GE15	GE21-24,XGE1-4
16	GE16	GE21-24,XGE1-4
17	GE17	GE21-24,XGE1-4
18	GE18	GE21-24,XGE1-4
19	GE19	GE21-24,XGE1-4
20	GE20	GE21-24,XGE1-4
21	GE21	GE1-20
22	GE22	GE1-20
23	GE23	GE1-20
24	GE24	GE1-20
25	XGE1	GE1-20
26	XGE2	GE1-20
27	XGE3	GE1-20
28	XGE4	GE1-20

IV-10-9. Storm Control

To display Storm Control global setting web page, click **Security > Storm Control**.

Mode
 Packet / Sec
 Kbits / Sec

IFG
 Exclude
 Include

Port Setting Table

Entry	Port	State	Broadcast		Unknown Multicast		Unknown Unicast		Action	
			State	Rate (Kbps)	State	Rate (Kbps)	State	Rate (Kbps)		
<input type="checkbox"/>	1	GE1	Disabled	Disabled	10000	Disabled	10000	Disabled	10000	Drop
<input type="checkbox"/>	2	GE2	Disabled	Disabled	10000	Disabled	10000	Disabled	10000	Drop
<input type="checkbox"/>	3	GE3	Disabled	Disabled	10000	Disabled	10000	Disabled	10000	Drop
<input type="checkbox"/>	4	GE4	Disabled	Disabled	10000	Disabled	10000	Disabled	10000	Drop
<input type="checkbox"/>	5	GE5	Disabled	Disabled	10000	Disabled	10000	Disabled	10000	Drop
<input type="checkbox"/>	6	GE6	Disabled	Disabled	10000	Disabled	10000	Disabled	10000	Drop
<input type="checkbox"/>	7	GE7	Disabled	Disabled	10000	Disabled	10000	Disabled	10000	Drop
<input type="checkbox"/>	8	GE8	Disabled	Disabled	10000	Disabled	10000	Disabled	10000	Drop
<input type="checkbox"/>	9	GE9	Disabled	Disabled	10000	Disabled	10000	Disabled	10000	Drop
<input type="checkbox"/>	10	GE10	Disabled	Disabled	10000	Disabled	10000	Disabled	10000	Drop
<input type="checkbox"/>	11	GE11	Disabled	Disabled	10000	Disabled	10000	Disabled	10000	Drop
<input type="checkbox"/>	12	GE12	Disabled	Disabled	10000	Disabled	10000	Disabled	10000	Drop
<input type="checkbox"/>	13	GE13	Disabled	Disabled	10000	Disabled	10000	Disabled	10000	Drop
<input type="checkbox"/>	14	GE14	Disabled	Disabled	10000	Disabled	10000	Disabled	10000	Drop
<input type="checkbox"/>	15	GE15	Disabled	Disabled	10000	Disabled	10000	Disabled	10000	Drop
<input type="checkbox"/>	16	GE16	Disabled	Disabled	10000	Disabled	10000	Disabled	10000	Drop
<input type="checkbox"/>	17	GE17	Disabled	Disabled	10000	Disabled	10000	Disabled	10000	Drop
<input type="checkbox"/>	18	GE18	Disabled	Disabled	10000	Disabled	10000	Disabled	10000	Drop
<input type="checkbox"/>	19	GE19	Disabled	Disabled	10000	Disabled	10000	Disabled	10000	Drop

Item	Description
Mode(Unit)	Select the unit of storm control <ul style="list-style-type: none"> ● Packet / Sec: storm control rate calculates by packet-based ● Kbits / Sec: storm control rate calculates by octet-based.
IFG	Select the rate calculates w/o preamble & IFG (20 bytes) <ul style="list-style-type: none"> ● Excluded: exclude preamble & IFG (20 bytes) when count ingress storm control rate. ● Included: include preamble & IFG (20 bytes) when count ingress storm control rate.

Click "Edit" button to view Edit Port Setting menu.

Edit Port Setting

Port	GE1
State	<input type="checkbox"/> Enable
Broadcast	<input type="checkbox"/> Enable <input type="text" value="10000"/> Kbps (16 - 1000000, default 10000)
Unknown Multicast	<input type="checkbox"/> Enable <input type="text" value="10000"/> Kbps (16 - 1000000, default 10000)
Unknown Unicast	<input type="checkbox"/> Enable <input type="text" value="10000"/> Kbps (16 - 1000000, default 10000)
Action	<input checked="" type="radio"/> Drop <input type="radio"/> Shutdown

Item	Description
Port	Select the setting ports.
State	Select the state of setting Enable: Enable the storm control function.
Broadcast	Enable: Enable the storm control function of Broadcast packet. Value of storm control rate, Unit: pps (packet per-second, range 1- 262143) or Kbps (Kbits per-second, range16 - 1000000) depends on global mode setting.
Unknown Multicast	Enable: Enable the storm control function of Unknown multicast packet. Value of storm control rate, Unit: pps (packet per-second, range 1- 262143) or Kbps (Kbits per-second, range16 - 1000000) depends on global mode setting.
Unknown Unicast	Enable: Enable the storm control function of Unknown unicast packet. Value of storm control rate, Unit: pps (packet per-second, range 1 - 262143) or Kbps (Kbits per-second, range16 - 1000000) depends on global mode setting.
Action	Select the state of setting <ul style="list-style-type: none"> ● Drop: Packets exceed storm control rate will be dropped. ● Shutdown: Port will be shut down when packets exceed storm control rate.

IV-10-10. DoS

A Denial of Service (DoS) attack is a hacker attempt to make a device unavailable to its users. DoS attacks saturate the device with external communication requests, so that it cannot respond to legitimate traffic. These attacks usually lead to a device CPU overload.

The DoS protection feature is a set of predefined rules that protect the network from malicious attacks. The DoS Security Suite Settings enables activating the security suite.

IV-10-10-1. Property

To display Dos Global Setting web page, click **Security > Dos > Property**.

POD	<input checked="" type="checkbox"/> Enable
Land	<input checked="" type="checkbox"/> Enable
UDP Blat	<input checked="" type="checkbox"/> Enable
TCP Blat	<input checked="" type="checkbox"/> Enable
DMAC = SMAC	<input checked="" type="checkbox"/> Enable
Null Scan Attack	<input checked="" type="checkbox"/> Enable
X-Mas Scan Attack	<input checked="" type="checkbox"/> Enable
TCP SYN-FIN Attack	<input checked="" type="checkbox"/> Enable
TCP SYN-RST Attack	<input checked="" type="checkbox"/> Enable
ICMP Fragment	<input checked="" type="checkbox"/> Enable
TCP-SYN	<input checked="" type="checkbox"/> Enable Note: Source Port < 1024
TCP Fragment	<input checked="" type="checkbox"/> Enable Note: Offset = 1
Ping Max Size	<input checked="" type="checkbox"/> Enable IPv4 <input checked="" type="checkbox"/> Enable IPv6 <input type="text" value="512"/> Byte (0 - 65535, default 512)
TCP Min Hdr size	<input checked="" type="checkbox"/> Enable <input type="text" value="20"/> Byte (0 - 31, default 20)
IPv6 Min Fragment	<input checked="" type="checkbox"/> Enable <input type="text" value="1240"/> Byte (0 - 65535, default 1240)
Smurf Attack	<input checked="" type="checkbox"/> Enable <input type="text" value="0"/> Netmask Length (0 - 32, default 0)

Apply

Item	Description
POD	Avoids ping of death attack.
Land	Drops the packets if the source IP address is equal to the destination IP address.
UDP Blat	Drops the packets if the UDP source port equals to the UDP destination port.
TCP Blat	Drops the packages if the TCP source port is equal to the TCP destination port.
DMAC = SMAC	Drops the packets if the destination MAC address is equal to

	the source MAC address.
Null Scan Attack	Drops the packets with NULL scan.
X-Mas Scan Attack	Drops the packets if the sequence number is zero, and the FIN, URG and PSH bits are set.
TCP SYN-FIN Attack	Drops the packets with SYN and FIN bits set.
TCP SYN-RST Attack	Drops the packets with SYN and RST bits set
ICMP Fragment	Drops the fragmented ICMP packets.
TCP SYN (SPORT<1024)	Drops SYN packets with sport less than 1024.
TCP Fragment (Offset = 1)	Drops the TCP fragment packets with offset equals to one.
Ping Max Size	Specify the maximum size of the ICMPv4/ICMPv6 ping packets. The valid range is from 0 to 65535 bytes, and the default value is 512 bytes.
IPv6 Min Fragment	Checks the minimum size of IPv6 fragments, and drops the packets smaller than the minimum size. The valid range is from 0 to 65535 bytes, and default value is 1240 bytes.
Smurf Attack	Avoids smurf attack. The length range of the netmask is from 0 to 323 bytes, and default length is 0 bytes.

IV-10-10-2. Port Setting

To configure and display the state of DoS protection for interfaces, click **Security > DoS > Port Setting**.



Entry	Port	State
<input type="checkbox"/>	1 GE1	Disabled
<input type="checkbox"/>	2 GE2	Disabled
<input type="checkbox"/>	3 GE3	Disabled
<input type="checkbox"/>	4 GE4	Disabled
<input type="checkbox"/>	5 GE5	Disabled
<input type="checkbox"/>	6 GE6	Disabled
<input type="checkbox"/>	7 GE7	Disabled
<input type="checkbox"/>	8 GE8	Disabled
<input type="checkbox"/>	9 GE9	Disabled
<input type="checkbox"/>	10 GE10	Disabled
<input type="checkbox"/>	11 GE11	Disabled
<input type="checkbox"/>	12 GE12	Disabled
<input type="checkbox"/>	13 GE13	Disabled
<input type="checkbox"/>	14 GE14	Disabled
<input type="checkbox"/>	15 GE15	Disabled
<input type="checkbox"/>	16 GE16	Disabled
<input type="checkbox"/>	17 GE17	Disabled
<input type="checkbox"/>	18 GE18	Disabled
<input type="checkbox"/>	19 GE19	Disabled
<input type="checkbox"/>	20 GE20	Disabled
<input type="checkbox"/>	21 GE21	Disabled
<input type="checkbox"/>	22 GE22	Disabled
<input type="checkbox"/>	23 GE23	Disabled
<input type="checkbox"/>	24 GE24	Disabled
<input type="checkbox"/>	25 XGE1	Disabled
<input type="checkbox"/>	26 XGE2	Disabled
<input type="checkbox"/>	27 XGE3	Disabled
<input type="checkbox"/>	28 XGE4	Disabled

Search:

Item	Description
Port	Interface or port number.
State	Enable/Disable the DoS protection on the interface.

IV-10-11. DHCP Snooping

Use the DHCP Snooping pages to configure settings of DHCP Snooping.

IV-10-11-1. Property

This page allow user to configure global and per interface settings of DHCP Snooping.

To display property page, click **Security > DHCP Snooping > Property**.

State

 Enable

VLAN

Available VLAN

VLAN 1

>

<

Selected VLAN

Port Setting Table



<input type="checkbox"/>	Entry	Port	Trust	Verify Chaddr	Rate Limit
<input type="checkbox"/>	1	GE1	Disabled	Disabled	Unlimited
<input type="checkbox"/>	2	GE2	Disabled	Disabled	Unlimited
<input type="checkbox"/>	3	GE3	Disabled	Disabled	Unlimited
<input type="checkbox"/>	4	GE4	Disabled	Disabled	Unlimited
<input type="checkbox"/>	5	GE5	Disabled	Disabled	Unlimited
<input type="checkbox"/>	6	GE6	Disabled	Disabled	Unlimited
<input type="checkbox"/>	7	GE7	Disabled	Disabled	Unlimited
<input type="checkbox"/>	8	GE8	Disabled	Disabled	Unlimited
<input type="checkbox"/>	9	GE9	Disabled	Disabled	Unlimited
<input type="checkbox"/>	10	GE10	Disabled	Disabled	Unlimited

Item	Description
------	-------------

State	Set checkbox to enable/disable DHCP Snooping function.
VLAN	Select VLANs in left box then move to right to enable DHCP Snooping. Or select VLANs in right box then move to left to disable DHCP Snooping.
Port Setting Table	
Port	Display port ID.
Trust	Display enable/disabled trust attribute of interface.
Verify Chaddr	Display enable/disabled chaddr validation attribute of interface.
Rate Limit	Display rate limitation value of interface.

Click "**Edit**" button to view Edit Port Setting menu.

Edit Port Setting

The screenshot shows a dialog box titled "Edit Port Setting" with a yellow background. It contains four rows of settings, each with a label on the left and a value or control on the right:

- Port:** GE1
- Trust:** Enable
- Verify Chaddr:** Enable
- Rate Limit:** 0 pps (0 - 300, default 0), 0 is Unlimited

At the bottom of the dialog are two buttons: "Apply" and "Close".

Item	Description
Port	Display selected port to be edited
Trust	Set checkbox to enable/disabled trust of interface. All DHCP packet will be forward directly if enable trust. Default is disabled.
Verify Chaddr	Set checkbox to enable or disable chaddr validation of interface. All DHCP packets will be checked whether client hardware mac address is same as source mac in Ethernet header if enable chaddr validation. Default is disabled.
Rate Limit	Input rate limitation of DHCP packets. The unit is pps. 0 means unlimited. Default is unlimited.

IV-10-11-2. Statistics

This page allow user to browse all statistics that recorded by DHCP snooping function.

To view the Statistics menu, navigate to **Security > DHCP Snooping > Statistics**.

Entry	Port	Forward	Chaddr Check Drop	Untrust Port Drop	Untrust Port with Option82 Drop	Invalid Drop
<input type="checkbox"/>	1 GE1	0	0	0	0	0
<input type="checkbox"/>	2 GE2	0	0	0	0	0
<input type="checkbox"/>	3 GE3	0	0	0	0	0
<input type="checkbox"/>	4 GE4	0	0	0	0	0
<input type="checkbox"/>	5 GE5	0	0	0	0	0
<input type="checkbox"/>	6 GE6	0	0	0	0	0
<input type="checkbox"/>	7 GE7	0	0	0	0	0
<input type="checkbox"/>	8 GE8	0	0	0	0	0
<input type="checkbox"/>	9 GE9	0	0	0	0	0
<input type="checkbox"/>	10 GE10	0	0	0	0	0
<input type="checkbox"/>	11 GE11	0	0	0	0	0
<input type="checkbox"/>	12 GE12	0	0	0	0	0
<input type="checkbox"/>	13 GE13	0	0	0	0	0
<input type="checkbox"/>	14 GE14	0	0	0	0	0
<input type="checkbox"/>	15 GE15	0	0	0	0	0
<input type="checkbox"/>	16 GE16	0	0	0	0	0
<input type="checkbox"/>	17 GE17	0	0	0	0	0
<input type="checkbox"/>	18 GE18	0	0	0	0	0
<input type="checkbox"/>	19 GE19	0	0	0	0	0
<input type="checkbox"/>	20 GE20	0	0	0	0	0
<input type="checkbox"/>	21 GE21	0	0	0	0	0
<input type="checkbox"/>	22 GE22	0	0	0	0	0
<input type="checkbox"/>	23 GE23	0	0	0	0	0
<input type="checkbox"/>	24 GE24	0	0	0	0	0
<input type="checkbox"/>	25 XGE1	0	0	0	0	0
<input type="checkbox"/>	26 XGE2	0	0	0	0	0
<input type="checkbox"/>	27 XGE3	0	0	0	0	0
<input type="checkbox"/>	28 XGE4	0	0	0	0	0
<input type="checkbox"/>	29 LAG1	0	0	0	0	0
<input type="checkbox"/>	30 LAG2	0	0	0	0	0
<input type="checkbox"/>	31 LAG3	0	0	0	0	0
<input type="checkbox"/>	32 LAG4	0	0	0	0	0
<input type="checkbox"/>	33 LAG5	0	0	0	0	0
<input type="checkbox"/>	34 LAG6	0	0	0	0	0
<input type="checkbox"/>	35 LAG7	0	0	0	0	0
<input type="checkbox"/>	36 LAG8	0	0	0	0	0

Clear Refresh

Item	Description
Port	Display port ID.
Forwarded	Display how many packets forwarded normally.
Chaddr Check Drop	Display how many packets dropped by chaddr validation.
Untrusted Port Drop	Display how many DHCP server packets that are received by untrusted port dropped.
Untrusted Port with Option82 Drop	Display how many packets dropped by untrusted port with option82 checking.
Invalid Drop	Display how many packets dropped by invalid checking.

IV-10-11-3. Option82 Property

This page allow user to set string of DHCP option82 remote ID filed. The string will attach in option82 if option inserted.

To display Option82 Property page, click **Security > DHCP Snooping > Option82 Property**.

Remote ID
 User Defined

Operational Status

Remote ID 74:da:38:17:6e:7a (Switch Mac in Byte Order)

Apply

Port Setting Table

<input type="checkbox"/>	Entry	Port	State	Allow Untrust
<input type="checkbox"/>	1	GE1	Disabled	Drop
<input type="checkbox"/>	2	GE2	Disabled	Drop
<input type="checkbox"/>	3	GE3	Disabled	Drop
<input type="checkbox"/>	4	GE4	Disabled	Drop
<input type="checkbox"/>	5	GE5	Disabled	Drop
<input type="checkbox"/>	6	GE6	Disabled	Drop
<input type="checkbox"/>	7	GE7	Disabled	Drop
<input type="checkbox"/>	8	GE8	Disabled	Drop
<input type="checkbox"/>	9	GE9	Disabled	Drop
<input type="checkbox"/>	10	GE10	Disabled	Drop
<input type="checkbox"/>	11	GE11	Disabled	Drop
<input type="checkbox"/>	12	GE12	Disabled	Drop
<input type="checkbox"/>	13	GE13	Disabled	Drop
<input type="checkbox"/>	14	GE14	Disabled	Drop
<input type="checkbox"/>	15	GE15	Disabled	Drop
<input type="checkbox"/>	16	GE16	Disabled	Drop
<input type="checkbox"/>	17	GE17	Disabled	Drop
<input type="checkbox"/>	18	GE18	Disabled	Drop
<input type="checkbox"/>	19	GE19	Disabled	Drop
<input type="checkbox"/>	20	GE20	Disabled	Drop
<input type="checkbox"/>	21	GE21	Disabled	Drop
<input type="checkbox"/>	22	GE22	Disabled	Drop

Item	Description
User Defined	Set checkbox to enable user-defined remote-ID. By default, remote ID is switch mac in byte order.
Remote ID	Input user-defined remote ID. Only available when enable user-define remote ID.
Port Setting Table	
Port	Display port ID.
State	Display option82 enable/disable status of interface.
Allow untrusted	Display allow untrusted action of interface.

Click "**Edit**" button to view Edit Port Setting menu.

Edit Port Setting

Port	GE1
State	<input type="checkbox"/> Enable
Allow Untrust	<input type="radio"/> Keep <input checked="" type="radio"/> Drop <input type="radio"/> Replace

Item	Description
Port	Display selected port to be edited
State	Set checkbox to enable/disable option82 function of interface.
Allow untrusted	Select the action perform when untrusted port receive DHCP packet has option82 filed. Default is drop. <ul style="list-style-type: none"> ● Keep: Keep original option82 content. ● Replace: Replace option82 content by switch setting ● Drop: Drop packets with option82

IV-10-11-4. Option82 Circuit ID

This page allow user to set string of DHCP option82 circuit ID filed. The string will attach in option82 if option inserted.

To display Option82 Circuit ID page, click **Security > DHCP Snooping > Option82 Circuit ID**.

Option82 Circuit ID Table

Showing entries Showing 0 to 0 of 0 entries

<input type="checkbox"/>	Port	VLAN	Circuit ID
0 results found.			

Item	Description
Port	Display port ID of entry.
VLAN	Display associate VLAN of entry.
Circuit ID	Display circuit ID string of entry.

Click “**Add**” button or “**Edit**” button to view the Add/Edit Option82 Circuit ID menu.

Add Option82 Circuit ID

Port	GE1 ▾
VLAN	<input type="text"/> (1 - 4094) (Keep empty to set without VLAN)
Circuit ID	<input type="text"/>

Apply Close

Edit Option82 Circuit ID

Port	
VLAN	
Circuit ID	<input type="text"/>

Apply Close

Item	Description
Port	Select port from list to associate to CID entry. Only available on Add dialog.
VLAN	Input VLAN ID to associate to circuit ID entry. VLAN ID is not mandatory. Only available on Add dialog.
Circuit ID	Input String as circuit ID. Packets match port and VLAN will be inserted circuit ID.

IV-10-12. IP Source Guard

Use the IP Source Guard pages to configure settings of IP Source Guard.

IV-10-12-1. Port Setting

Use the IP Source Guard pages to configure settings of IP Source Guard.

To display Port Setting page, click **Security > IP Source Guard > Port Setting**.

Entry	Port	State	Verify Source	Current Entry	Max Entry
1	GE1	Disabled	IP	0	1
2	GE2	Disabled	IP	0	Unlimited
3	GE3	Disabled	IP	0	Unlimited
4	GE4	Disabled	IP	0	Unlimited
5	GE5	Disabled	IP	0	Unlimited
6	GE6	Disabled	IP	0	Unlimited
7	GE7	Disabled	IP	0	Unlimited
8	GE8	Disabled	IP	0	Unlimited
9	GE9	Disabled	IP	0	Unlimited
10	GE10	Disabled	IP	0	Unlimited
11	GE11	Disabled	IP	0	Unlimited
12	GE12	Disabled	IP	0	Unlimited
13	GE13	Disabled	IP	0	Unlimited
14	GE14	Disabled	IP	0	Unlimited
15	GE15	Disabled	IP	0	Unlimited
16	GE16	Disabled	IP	0	Unlimited
17	GE17	Disabled	IP	0	Unlimited
18	GE18	Disabled	IP	0	Unlimited
19	GE19	Disabled	IP	0	Unlimited
20	GE20	Disabled	IP	0	Unlimited
21	GE21	Disabled	IP	0	Unlimited
22	GE22	Disabled	IP	0	Unlimited
23	GE23	Disabled	IP	0	Unlimited
24	GE24	Disabled	IP	0	Unlimited
25	XGE1	Disabled	IP	0	Unlimited
26	XGE2	Disabled	IP	0	Unlimited
27	XGE3	Disabled	IP	0	Unlimited
28	XGE4	Disabled	IP	0	Unlimited
29	LAG1	Disabled	IP	0	Unlimited
30	LAG2	Disabled	IP	0	Unlimited
31	LAG3	Disabled	IP	0	Unlimited
32	LAG4	Disabled	IP	0	Unlimited
33	LAG5	Disabled	IP	0	Unlimited
34	LAG6	Disabled	IP	0	Unlimited
35	LAG7	Disabled	IP	0	Unlimited
36	LAG8	Disabled	IP	0	Unlimited

Edit

Item	Description
Port	Display port ID.
State	Display IP Source Guard enable/disable status of interface.
Verify Source	Display mode of IP Source Guard verification
Current Binding Entry	Display current binding entries of a interface.
Max Binding Entry	Display the number of maximum binding entry of interface.

Click "**Edit**" button to view the Edit Port Setting menu.

Edit Port Setting

Port	GE1
State	<input type="checkbox"/> Enable
Verify Source	<input checked="" type="radio"/> IP <input type="radio"/> IP-MAC
Max Entry	<input style="width: 100px;" type="text" value="0"/> (0 - 50, default 0), 0 is Unlimited

Item	Description
Port	Display selected port to be edited.
Status	Set checkbox to enable or disable IP Source Guard function. Default is disabled.
Verify Source	Select the mode of IP Source Guard verification <input checked="" type="radio"/> IP: Only verify source IP address of packet.

	<ul style="list-style-type: none"> ● IP-MAC: Verify source IP and source MAC address of packet.
Max Entry	Input the maximum number of entries that a port can be bounded. Default is un-limited on all ports. No entry will be bound if limitation reached.

IV-10-12-2. IMPV Binding

This page allow user to add static IP source guard entry and browse all IP source guard entries that learned by DHCP snooping or statically create by user.

To display IPMV Binding page, click **Security > IP Source Guard > IMPV Binding**.

IP-MAC-Port-VLAN Binding Table

Showing All entries Showing 0 to 0 of 0 entries

<input type="checkbox"/>	Port	VLAN	MAC Address	IP Address	Binding	Type	Lease Time
0 results found.							

Item	Description
Port	Display port ID of entry.
VLAN	Display VLAN ID of entry.
MAC Address	Display MAC address of entry. Only available of IP-MAC binding entry.
IP Address	Display IP address of entry. Mask always to be 255.255.255.255 for IP-MAC binding. IP binding entry display user input.
Binding	Display binding type of entry.
Type	Type of existing binding entry <ul style="list-style-type: none"> ● Static: Entry added by user. ● Dynamic: Entry learned by DHCP snooping.
Lease Time	Lease time of DHCP Snooping learned entry. After lease time entry will be deleted. Only available of dynamic entry.

Click "**Add**" or "**Edit**" button to view the Add/Edit IP-MAC-Port-VLAN Binding menu.

Add IP-MAC-Port-VLAN Binding

Port	GE1 ▼
VLAN	<input type="text"/> (1 - 4094)
Binding	<input checked="" type="radio"/> IP-MAC-Port-VLAN <input type="radio"/> IP-Port-VLAN
MAC Address	<input type="text"/>
IP Address	<input type="text"/> / <input type="text"/> 255.255.255.255

Edit IP-MAC-Port-VLAN Binding

Port	GE1 ▼
VLAN	20
Binding	IP-MAC-Port-VLAN
MAC Address	00:11:22:33:44:55
IP Address	<input type="text"/> 192.168.2.33 / <input type="text"/> 255.255.255.255

Item	Description
Port	Select port from list of a binding entry.
VLAN	Specify a VLAN ID of a binding entry.
Binding	Select matching mode of binding entry IP-MAC-Port-VLAN: packet must match IP address 、 MAC address 、 Port and VLAN ID. IP-Port-VLAN: packet must match IP address or subnet 、 Port and VLAN ID.
MAC Address	Input MAC address. Only available on IP-MAC-Port-VLAN mode.
IP Address	Input IP address and mask. Mask only available on IP-MAC-Port mode.

IV-10-12-3. Save Database

This page allow user to configure DHCP snooping database which can backup and restore dynamic DHCP snooping entries.

To display Save Database page, click **Security > DHCP Snooping > Save Database**.

Item	Description
Type	Select the type of database agent. <ul style="list-style-type: none"> ● None: Disable database agent service. ● Flash: Save DHCP dynamic binding entries to flash. ● TFTP: Save DHCP dynamic binding entries to remote TFTP server.
Filename	Input filename for backup file. Only available when selecting type "flash" and "TFTP".
Address Type	Select the type of TFTP server. <ul style="list-style-type: none"> ● Hostname: TFTP server address is hostname. ● IPv4: TFTP server address is IPv4 address
Server Address	Input remote TFTP server hostname or IP address. Only available when selecting type "TFTP"
Write Delay	Input delay timer for doing backup after change happened. Default is 300 seconds.
Timeout	Input aborts timeout for doing backup failure. Default is 300 seconds.

IV-11. ACL

Use the ACL pages to configure settings for the switch ACL features..

IV-11-1. MAC ACL

This page allow user to add or delete ACL rule. A rule cannot be deleted if under binding.

To display MAC ACL page, click **ACL > MAC ACL**.

ACL Table

Showing All entries Showing 0 to 0 of 0 entries

<input type="checkbox"/>	ACL Name	Rule	Port
0 results found.			

Item	Description
ACL Name	Input MAC ACL name.
ACL Name	Display MAC ACL name.
Rule	Display the number ACE rule of ACL.
Port	Display the port list that bind this ACL.

IV-11-2. MAC ACE

This page allow user to add, edit or delete ACE rule. An ACE rule cannot be edited or deleted if ACL under binding. New ACE cannot be added if ACL under binding.

To display MAC ACE page, click **ACL > MAC ACE**.

ACE Table

ACL Name

Showing entries

Showing 0 to 0 of 0 entries

Sequence	Action	Source MAC		Destination MAC		Ethertype	VLAN	802.1p	
		Address	Mask	Address	Mask			Value	Mask
0 results found.									

Item	Description
ACL Name	Select the ACL name to which an ACE is being added.
Sequence	Display the sequence of ACE.
Action	Display the action of ACE.
Source MAC	Display the source MAC address and mask of ACE.
Destination MAC	Display the destination MAC address and mask of ACE.
Ethertype	Display the Ethernet frame type of ACE.
VLAN ID	Display the VLAN ID of ACE.
802.1p Value	Display the 802.1p value of ACE.
802.1p Mask	Display the 802.1p mask of ACE.

Click “**Edit**” button to view the Edit ACE menu.

Edit ACE

ACL Name	666
Sequence	555
Action	<input checked="" type="radio"/> Permit <input type="radio"/> Deny <input type="radio"/> Shutdown
Source MAC	<input checked="" type="checkbox"/> Any <input type="text"/> / <input type="text"/> (Address / Mask)
Destination MAC	<input checked="" type="checkbox"/> Any <input type="text"/> / <input type="text"/> (Address / Mask)
Ethertype	<input checked="" type="checkbox"/> Any 0x <input type="text"/> (0x600 ~ 0xFFFF)
VLAN	<input checked="" type="checkbox"/> Any <input type="text"/> (1 - 4094)
802.1p	<input checked="" type="checkbox"/> Any <input type="text"/> / <input type="text"/> (Value / Mask) (0 - 7)

Item	Description
ACL Name	Display the ACL name to which an ACE is being added..
Sequence	Specify the sequence of the ACE. ACEs with higher sequence are processed first (1 is the highest priority). Only available on Add Dialog.
Action	Select the action after ACE match packet. <ul style="list-style-type: none"> ● Permit: Forward packets that meet the ACE criteria. ● Deny: Drop packets that meet the ACE criteria. ● Shutdown: Drop packets that meet the ACE criteria, and disable the port from where the packets were received. Such ports can be reactivated from the Port Settings page.
Source MAC	Select the type for source MAC address. <ul style="list-style-type: none"> ● Any: All source addresses are acceptable. ● User Defined: Only a source address or a range of source addresses which users define are acceptable. Enter the source MAC address and mask to which will be matched.
Destination	Select the type for Destination MAC address.

MAC	<ul style="list-style-type: none"> ● Any: All destination addresses are acceptable. ● User Defined: Only a destination address or a range of destination addresses which users define are acceptable. Enter the destination MAC address and mask to which will be matched.
Ethertype	<p>Select the type for Ethernet frame type.</p> <ul style="list-style-type: none"> ● Any: All Ethernet frame type is acceptable. ● User Defined: Only an Ethernet frame type which users define is acceptable. Enter the Ethernet frame type value to which will be matched.
VLAN	<p>Select the type for VLAN ID.</p> <ul style="list-style-type: none"> ● Any: All VLAN ID is acceptable. ● User Defined: Only a VLAN ID which users define is acceptable. Enter the VLAN ID to which will be matched.
802.1p	<p>Select the type for 802.1p value.</p> <ul style="list-style-type: none"> ● Any: All 802.1p value is acceptable. ● User Defined: Only an 802.1p value or a range of 802.1p value which users define is acceptable. Enter the 802.1p value and mask to which will be matched.

IV-11-3. IPv4 ACL

This page allow user to add or delete IPv4 ACL rule. A rule cannot be deleted if under binding.

To display IPv4 ACL page, click **ACL > IPv4 ACL**.

ACL Name

ACL Table

Showing All ▼ entries Showing 0 to 0 of 0 entries Q

<input type="checkbox"/>	ACL Name	Rule	Port
0 results found.			

Item	Description
------	-------------

ACL Name	Input IPv4 ACL name.
ACL Name	Display IPv4 ACL name.
Rule	Display the number ACE rule of ACL.
Port	Display the port list that bind this ACL.

IV-11-4. IPv4 ACE

This page allow user to add, edit or delete ACE rule. An ACE rule cannot be edited or deleted if ACL under binding. New ACE cannot be added if ACL under binding.

To display IPv4 ACE page, click **ACL > IPv4 ACE**.

ACE Table

ACL Name

Showing entries

Showing 0 to 0 of 0 entries

Sequence	Action	Protocol	Source IP		Destination IP		Source Port	Destination Port	TCP Flags	Type of Service		ICMP			
			Address	Mask	Address	Mask				DSCP	IP Precedence	Type	Code		
0 results found.															
											First	Previous	1	Next	Last

Item	Description
ACL Name	Select the ACL name to which an ACE is being added.
Sequence	Display the sequence of ACE.
Action	Display the action of ACE.
Protocol	Display the protocol value of ACE.
Source IP	Display the source IP address and mask of ACE.
Destination IP	Display the destination IP address and mask of ACE.
Source Port	Display single source port or a range of source ports of ACE. Only available when protocol is TCP or UDP.
Destination Port	Display single destination port or a range of destination ports of ACE. Only available when protocol is TCP or UDP.
TCP Flags	Display the TCP flag value if ACE. Only available when protocol is TCP.
Type of Service	Display the ToS value of ACE which could be DSCP or IP Precedence.
ICMP	Display the ICMP type and code of ACE. Only available when protocol is ICMP.

Click "**Add**" or "**Edit**" button to view the Add/Edit ACE menu.

Edit ACE

ACL Name	777
Sequence	888
Action	<input checked="" type="radio"/> Permit <input type="radio"/> Deny <input type="radio"/> Shutdown
Protocol	<input checked="" type="radio"/> Any <input type="radio"/> Select <input type="text" value="ICMP"/> <input type="button" value="v"/> <input type="radio"/> Define <input type="text" value=""/> (0 - 255)
Source IP	<input checked="" type="checkbox"/> Any <input type="text" value=""/> / <input type="text" value=""/> (Address / Mask)
Destination IP	<input checked="" type="checkbox"/> Any <input type="text" value=""/> / <input type="text" value=""/> (Address / Mask)
Type of Service	<input checked="" type="radio"/> Any <input type="radio"/> DSCP <input type="text" value=""/> (0 - 63) <input type="radio"/> IP Precedence <input type="text" value=""/> (0 - 7)
Source Port	<input checked="" type="radio"/> Any <input type="radio"/> Single <input type="text" value=""/> (0 - 65535) <input type="radio"/> Range <input type="text" value=""/> - <input type="text" value=""/> (0 - 65535)
Destination Port	<input checked="" type="radio"/> Any <input type="radio"/> Single <input type="text" value=""/> (0 - 65535) <input type="radio"/> Range <input type="text" value=""/> - <input type="text" value=""/> (0 - 65535)
TCP Flags	Urg: <input type="radio"/> Set <input type="radio"/> Unset <input checked="" type="radio"/> Don't care Ack: <input type="radio"/> Set <input type="radio"/> Unset <input checked="" type="radio"/> Don't care Psh: <input type="radio"/> Set <input type="radio"/> Unset <input checked="" type="radio"/> Don't care Rst: <input type="radio"/> Set <input type="radio"/> Unset <input checked="" type="radio"/> Don't care Syn: <input type="radio"/> Set <input type="radio"/> Unset <input checked="" type="radio"/> Don't care Fin: <input type="radio"/> Set <input type="radio"/> Unset <input checked="" type="radio"/> Don't care
ICMP Type	<input checked="" type="radio"/> Any <input type="radio"/> Select <input type="text" value="Echo Reply"/> <input type="button" value="v"/> <input type="radio"/> Define <input type="text" value=""/> (0 - 255)
ICMP Code	<input checked="" type="radio"/> Any <input type="radio"/> Define <input type="text" value=""/> (0 - 255)

Apply

Close

Item	Description
ACL Name	Display the ACL name to which an ACE is being added.
Sequence	Specify the sequence of the ACE. ACEs with higher sequence are processed first (1 is the highest sequence). Only available on Add dialog.
Action	Select the action for a match. <ul style="list-style-type: none"> ● Permit: Forward packets that meet the ACE criteria. ● Deny: Drop packets that meet the ACE criteria. ● Shutdown: Drop packets that meet the ACE criteria, and disable the port from where the packets were received. Such ports can be reactivated from the Port Settings page.
Protocol	Select the type of protocol for a match. <ul style="list-style-type: none"> ● Any (IP): All IP protocols are acceptable. ● Select from list: Select one of the following protocols from the drop-down list. ICMP/IPinIP/TCP/EGP/IGP/UDP/HMP/RDP/IPV6/IPV6:ROUT/IPV6:F RAG/ RSVP/IPV6:ICMP/OSPF/PIM/L2TP ● Protocol ID to match: Enter the protocol ID.
Source IP	Select the type for source IP address. <ul style="list-style-type: none"> ● Any: All source addresses are acceptable. ● User Defined: Only a source address or a range of source addresses which users define are acceptable. Enter the source IP address value and mask to which will be matched.
Destination IP	Select the type for destination IP address. <ul style="list-style-type: none"> ● Any: All destination addresses are acceptable. ● User Defined: Only a destination address or a range of destination addresses which users define are acceptable. Enter the destination IP address value and mask to which will be matched.
Source Port	Select the type of protocol for a match. Only available when protocol is TCP or UDP. <ul style="list-style-type: none"> ● Any: All source ports are acceptable. ● Single: Enter a single TCP/UDP source port to which packets are matched. ● Range: Select a range of TCP/UDP source ports to which the packet is matched. There are eight different port ranges that can be configured (shared between source and destination ports). TCP and UDP protocols each have eight port ranges.
Destination Port	Select the type of protocol for a match. Only available when protocol is TCP or UDP. <ul style="list-style-type: none"> ● Any: All source ports are acceptable. ● Single: Enter a single TCP/UDP source port to which packets are

	<p>matched.</p> <ul style="list-style-type: none"> ● Range: Select a range of TCP/UDP source ports to which the packet is matched. There are eight different port ranges that can be configured (shared between source and destination ports). TCP and UDP protocols each have eight port ranges.
TCP Flags	<p>Select one or more TCP flags with which to filter packets. Filtered packets are either forwarded or dropped. Filtering packets by TCP flags increases packet control, which increases network security. Only available when protocol is TCP.</p>
Type of Service	<p>Select the type of service for a match.</p> <ul style="list-style-type: none"> ● Any: All types of service are acceptable. ● DSCP to match: Enter a Differentiated Services Code Point (DSCP) to match. ● IP Precedence to match: Enter a IP Precedence to match.
ICMP Type	<p>Either select the message type by name or enter the message type number. Only available when protocol is ICMP.</p> <ul style="list-style-type: none"> ● Any: All message types are acceptable. ● Select from list: Select message type by name. ● Protocol ID to match: Enter the number of message type.
ICMP Code	<p>Select the type for ICMP code. Only available when protocol is ICMP.</p> <ul style="list-style-type: none"> ● Any: All codes are acceptable. ● User Defined: Enter an ICMP code to match.

IV-11-5. ACL Binding

This page allow user to bind or unbind ACL rule to or from interface. IPv4 and Ipv6 ACL cannot be bound to the same port simultaneously.

To display ACL Binding page, click **ACL > ACL Binding**.

Entry	Port	MAC ACL	IPv4 ACL
1	GE1		
2	GE2		
3	GE3		
4	GE4		
5	GE5		
6	GE6		
7	GE7		
8	GE8		
9	GE9		
10	GE10		
11	GE11		
12	GE12		
13	GE13		
14	GE14		
15	GE15		
16	GE16		
17	GE17		
18	GE18		
19	GE19		
20	GE20		
21	GE21		
22	GE22		
23	GE23		
24	GE24		
25	XGE1		
26	XGE2		
27	XGE3		
28	XGE4		
29	LAG1		
30	LAG2		
31	LAG3		
32	LAG4		
33	LAG5		
34	LAG6		
35	LAG7		
36	LAG8		

Buttons: Bind, Unbind, Edit

Item	Description
Port	Display port entry ID.
MAC ACL	Display mac ACL name that bound of interface. Empty means no rule bound.
IPv4 ACL	Display ipv4 ACL name that bound of interface. Empty means no rule bound.
IPv6 ACL	Display ipv6 ACL name that bound of interface. Empty means no rule bound.

Click **“Edit”** button to view the Edit ACL Binding menu.

Add ACL Binding

Port: GE1
 Note: ACL without any rules cannot be bound

MAC ACL:

IPv4 ACL:

IPv6 ACL:

Buttons: Apply, Close

Item	Description
Port	Display port entry ID.
MAC ACL	Select mac ACL name from list to bind.
IPv4 ACL	Select IPv4 ACL name from list to bind.
IPv6 ACL	Select IPv6 ACL name from list to bind.

IV-12. QoS

Use the QoS pages to configure settings for the switch QoS interface.

IV-12-1. General

Use the QoS general pages to configure settings for general purpose.

IV-12-1-1. Property

To display Property web page, click **QoS > General > Property**.

The screenshot shows the configuration interface for QoS. It includes a 'State' section with an 'Enable' checkbox and a 'Trust Mode' section with radio buttons for 'CoS' (selected) and 'IP Precedence'. Below these is an 'Apply' button. A table lists 36 entries with columns for Entry, Port, CoS, Trust, and Remarkings (CoS, IP Precedence).

Entry	Port	CoS	Trust	Remarkings	
				CoS	IP Precedence
1	GE1	0	Enabled	Disabled	Disabled
2	GE2	0	Enabled	Disabled	Disabled
3	GE3	0	Enabled	Disabled	Disabled
4	GE4	0	Enabled	Disabled	Disabled
5	GE5	0	Enabled	Disabled	Disabled
6	GE6	0	Enabled	Disabled	Disabled
7	GE7	0	Enabled	Disabled	Disabled
8	GE8	0	Enabled	Disabled	Disabled
9	GE9	0	Enabled	Disabled	Disabled
10	GE10	0	Enabled	Disabled	Disabled
11	GE11	0	Enabled	Disabled	Disabled
12	GE12	0	Enabled	Disabled	Disabled
13	GE13	0	Enabled	Disabled	Disabled
14	GE14	0	Enabled	Disabled	Disabled
15	GE15	0	Enabled	Disabled	Disabled
16	GE16	0	Enabled	Disabled	Disabled
17	GE17	0	Enabled	Disabled	Disabled
18	GE18	0	Enabled	Disabled	Disabled
19	GE19	0	Enabled	Disabled	Disabled
20	GE20	0	Enabled	Disabled	Disabled
21	GE21	0	Enabled	Disabled	Disabled
22	GE22	0	Enabled	Disabled	Disabled
23	GE23	0	Enabled	Disabled	Disabled
24	GE24	0	Enabled	Disabled	Disabled
25	XGE1	0	Enabled	Disabled	Disabled
26	XGE2	0	Enabled	Disabled	Disabled
27	XGE3	0	Enabled	Disabled	Disabled
28	XGE4	0	Enabled	Disabled	Disabled
29	LAG1	0	Enabled	Disabled	Disabled
30	LAG2	0	Enabled	Disabled	Disabled
31	LAG3	0	Enabled	Disabled	Disabled
32	LAG4	0	Enabled	Disabled	Disabled
33	LAG5	0	Enabled	Disabled	Disabled
34	LAG6	0	Enabled	Disabled	Disabled
35	LAG7	0	Enabled	Disabled	Disabled
36	LAG8	0	Enabled	Disabled	Disabled

Item	Description
State	Set checkbox to enable/disable QoS.
Trust	Select QoS trust mode <ul style="list-style-type: none">● CoS: Traffic is mapped to queues based on the CoS field in the VLAN tag, or based on the per-port default CoS value (if there is no VLAN tag on the incoming packet), the actual mapping of the CoS to queue can be configured on port setting dialog.

	<ul style="list-style-type: none"> ● CoS-DSCP: Uses the trust CoS mode for non-IP traffic and trust DSCP mode for IP traffic. ● IP Precedence: Traffic is mapped to queues based on the IP precedence. The actual mapping of the IP precedence to queue can be configured on the IP Precedence mapping page.
Port Setting Table	
Port	Port name
CoS	Port default CoS priority value for the selected ports.
Trust	Port trust state <ul style="list-style-type: none"> ● Enabled: Traffic will follow trust mode in global setting ● Disabled: Traffic will always use best efforts
Remarking (CoS)	Set checkbox to enable/disable port CoS remarking. <ul style="list-style-type: none"> ● Enabled: CoS remarking is enabled ● Disabled: CoS remarking is disabled
Remarking (IP Precedence)	Set checkbox to enable/disable port IP Precedence remarking. <ul style="list-style-type: none"> ● Enabled: DSCP remarking is enabled ● Disabled: DSCP remarking is disabled

Click "**Edit**" button to view the Edit Port Setting menu.

Edit Port Setting

Port	GE1
CoS	<input style="width: 60px;" type="text" value="0"/> (0 - 7)
Trust	<input checked="" type="checkbox"/> Enable

Remarking

CoS	<input type="checkbox"/> Enable
DSCP	<input type="checkbox"/> Enable
IP Precedence	<input type="checkbox"/> Enable

Item	Description
Port	Selected port list.
CoS	Set default CoS/802.1p priority value for the selected ports.
Trust	Set checkbox to enable/disable port trust state.
Remarking (CoS)	Set checkbox to enable/disable port CoS remarking.
Remarking (IP Precedence)	Set checkbox to enable/disable port IP Precedence remarking.

IV-12-1-2. Queue Scheduling

The switch supports eight queues for each interface. Queue number 8 is the highest priority queue.

Queue number 1 is the lowest priority queue. There are two ways of determining how traffic in queues is handled, Strict Priority (SP) and Weighted Round Robin (WRR).

- Strict Priority (SP)—Egress traffic from the highest priority queue is transmitted first. Traffic from the lower queues is processed only after the highest queue has been transmitted, which provide the highest level of priority of traffic to the highest numbered queue.
- Weighted Round Robin (WRR)—In WRR mode the number of packets sent from the queue is proportional to the weight of the queue (the higher the weight, the more frames are sent).

The queuing modes can be selected on the Queue page. When the queuing mode is by Strict Priority, the priority sets the order in which queues are serviced, starting with queue_8 (the highest priority queue) and going to the next lower queue when each queue is completed.

When the queuing mode is Weighted Round Robin, queues are serviced until their quota has been used up and then another queue is serviced. It is also possible to assign some of the lower queues to WRR, while keeping some of the higher queues in Strict Priority. In this case traffic for the SP queues is always sent before traffic from the WRR queues. After the SP queues have been emptied, traffic from the WRR queues is forwarded. (The relative portion from each WRR queue depends on its weight).

To display Queue Scheduling web page, click **QoS > General > Queue Scheduling**

Queue Scheduling Table

Queue	Method			WRR Bandwidth (%)
	Strict Priority	WRR	Weight	
1	<input checked="" type="radio"/>	<input type="radio"/>	1	
2	<input checked="" type="radio"/>	<input type="radio"/>	2	
3	<input checked="" type="radio"/>	<input type="radio"/>	3	
4	<input checked="" type="radio"/>	<input type="radio"/>	4	
5	<input checked="" type="radio"/>	<input type="radio"/>	5	
6	<input checked="" type="radio"/>	<input type="radio"/>	9	
7	<input checked="" type="radio"/>	<input type="radio"/>	13	
8	<input checked="" type="radio"/>	<input type="radio"/>	15	

Apply

Item	Description
Queue	Queue ID to configure.
Strict Priority	Set queue to strict priority type.
WRR	Set queue to Weight round robin type.
Weight	If the queue type is WRR, set the queue weight for the queue.
WRR Bandwidth	Percentage of WRR queue bandwidth.

IV-12-1-3. CoS Mapping

The CoS to Queue table determines the egress queues of the incoming packets based on the 802.1p priority in their VLAN tags. For incoming untagged packets, the 802.1p priority will be the default CoS/802.1p priority assigned to the ingress ports. Use the Queues to CoS table to remark the CoS/802.1p priority for egress traffic from each queue.

To display CoS Mapping web page, click **QoS > General > CoS Mapping**.

CoS to Queue Mapping

CoS	Queue
0	2 ▼
1	1 ▼
2	3 ▼
3	4 ▼
4	5 ▼
5	6 ▼
6	7 ▼
7	8 ▼

Apply

Queue to CoS Mapping

Queue	CoS
1	1 ▼
2	0 ▼
3	2 ▼
4	3 ▼
5	4 ▼
6	5 ▼
7	6 ▼
8	7 ▼

Apply

Item	Description
CoS to Queue Mapping	
CoS	CoS value.
Queue	Select queue id for the CoS value.
Queue to CoS Mapping	
Queue	Queue ID
CoS	Select CoS value for the queue id.

IV-12-1-4. DSCP Mapping

DSCP to Queue Mapping

DSCP	Queue	DSCP	Queue	DSCP	Queue	DSCP	Queue
0 [CS0]	1	16 [CS2]	3	32 [CS4]	5	48 [CS6]	7
1	1	17	3	33	5	49	7
2	1	18 [AF21]	3	34 [AF41]	5	50	7
3	1	19	3	35	5	51	7
4	1	20 [AF22]	3	36 [AF42]	5	52	7
5	1	21	3	37	5	53	7
6	1	22 [AF23]	3	38 [AF43]	5	54	7
7	1	23	3	39	5	55	7
8 [CS1]	2	24 [CS3]	4	40 [CS5]	6	56 [CS7]	8
9	2	25	4	41	6	57	8
10 [AF11]	2	26 [AF31]	4	42	6	58	8
11	2	27	4	43	6	59	8
12 [AF12]	2	28 [AF32]	4	44	6	60	8
13	2	29	4	45	6	61	8
14 [AF13]	2	30 [AF33]	4	46 [EF]	6	62	8
15	2	31	4	47	6	63	8

Apply

IV-12-1-5. IP Precedence Mapping

This page allow user to configure IP Precedence to Queue mapping and Queue to IP Precedence mapping.

To display IP Precedence Mapping web page, click **QoS > General > IP Precedence Mapping**.

IP Precedence to Queue Mapping

IP Precedence	Queue
0	1 ▼
1	2 ▼
2	3 ▼
3	4 ▼
4	5 ▼
5	6 ▼
6	7 ▼
7	8 ▼

Apply

Queue to IP Precedence Mapping

Queue	IP Precedence
1	0 ▼
2	1 ▼
3	2 ▼
4	3 ▼
5	4 ▼
6	5 ▼
7	6 ▼
8	7 ▼

Apply

Item	Description
IP Precedence to Queue Mapping	
IP Precedence	IP Precedence value.
Queue	Queue value which IP Precedence is mapped.
Queue to IP Precedence Mapping	
Queue	Queue ID.
IP Precedence	IP Precedence value which queue is mapped.

IV-12-2. Rate Limit

Use the Rate Limit pages to define values that determine how much traffic the switch can receive and send on specific port or queue.

III-12-2-1. Ingress/Egress Port

This page allow user to configure ingress port rate limit and egress port rate limit. The ingress rate limit is the number of bits per second that can be received from the ingress interface. Excess bandwidth above this limit is discarded.

To display Ingress / Egress Port web page, click **QoS > Rate Limit > Ingress / Egress Port**.

Entry	Port	Ingress		Egress	
		State	Rate (Kbps)	State	Rate (Kbps)
<input type="checkbox"/>	1 GE1	Enabled	10000	Enabled	10000
<input type="checkbox"/>	2 GE2	Disabled		Disabled	
<input type="checkbox"/>	3 GE3	Disabled		Disabled	
<input type="checkbox"/>	4 GE4	Disabled		Disabled	
<input type="checkbox"/>	5 GE5	Disabled		Disabled	
<input type="checkbox"/>	6 GE6	Disabled		Disabled	
<input type="checkbox"/>	7 GE7	Disabled		Disabled	
<input type="checkbox"/>	8 GE8	Disabled		Disabled	
<input type="checkbox"/>	9 GE9	Disabled		Disabled	
<input type="checkbox"/>	10 GE10	Disabled		Disabled	
<input type="checkbox"/>	11 GE11	Disabled		Disabled	
<input type="checkbox"/>	12 GE12	Disabled		Disabled	
<input type="checkbox"/>	13 GE13	Disabled		Disabled	
<input type="checkbox"/>	14 GE14	Disabled		Disabled	
<input type="checkbox"/>	15 GE15	Disabled		Disabled	
<input type="checkbox"/>	16 GE16	Disabled		Disabled	
<input type="checkbox"/>	17 GE17	Disabled		Disabled	
<input type="checkbox"/>	18 GE18	Disabled		Disabled	
<input type="checkbox"/>	19 GE19	Disabled		Disabled	
<input type="checkbox"/>	20 GE20	Disabled		Disabled	
<input type="checkbox"/>	21 GE21	Disabled		Disabled	
<input type="checkbox"/>	22 GE22	Disabled		Disabled	
<input type="checkbox"/>	23 GE23	Disabled		Disabled	
<input type="checkbox"/>	24 GE24	Disabled		Disabled	
<input type="checkbox"/>	25 XGE1	Disabled		Disabled	
<input type="checkbox"/>	26 XGE2	Disabled		Disabled	
<input type="checkbox"/>	27 XGE3	Disabled		Disabled	
<input type="checkbox"/>	28 XGE4	Disabled		Disabled	

Item	Description
Port	Port name.
Ingress (State)	Port ingress rate limit state <ul style="list-style-type: none"> ● Enabled: Ingress rate limit is enabled ● Disabled: Ingress rate limit is disabled
Ingress (Rate)	Port ingress rate limit value if ingress rate state is enabled.
IP Precedence	IP Precedence value which queue is mapped.
Egress (State)	Port egress rate limit state <ul style="list-style-type: none"> ● Enabled: Egress rate limit is enabled ● Disabled: Egress rate limit is disabled
Egress (Rate)	Port egress rate limit value if egress rate state is enabled.

Click "**Edit**" button to view the Ingress / Egress Port menu.

Edit Ingress / Egress Port

Port	GE1
Ingress	<input type="checkbox"/> Enable 1000000 Kbps (16 - 1000000)
Egress	<input type="checkbox"/> Enable 1000000 Kbps (16 - 1000000)

Item	Description
Port	Select port list.
Ingress	Set checkbox to enable/disable ingress rate limit. If ingress rate limit is enabled, rate limit value need to be assigned.
Egress	Set checkbox to enable/disable egress rate limit. If egress rate limit is enabled, rate limit value need to be assigned.

IV-13. Diagnostics

Use the Diagnostics pages to configure settings for the switch diagnostics feature or operating diagnostic utilities.

IV-13-1. Logging

IV-13-1-1. Property

To enable/disable the logging service, click **Diagnostic > Logging > Property**.

State Enable

Console Logging

State Enable

Minimum Severity Notice ▼
 Note: Emergency, Alert, Critical, Error, Warning, Notice

RAM Logging

State Enable

Minimum Severity Notice ▼
 Note: Emergency, Alert, Critical, Error, Warning, Notice

Flash Logging

State Enable

Minimum Severity Notice ▼
 Note: Emergency, Alert, Critical, Error, Warning, Notice

Apply

Item	Description
State	Enable/Disable the global logging services. When the logging service is enabled, logging configuration of each destination rule can be individually configured. If the logging service is disabled, no messages will be sent to these destinations.
Console Logging	
State	Enable/Disable the console logging service
Minimum Severity	The minimum severity for the console logging.
RAM Logging	
State	Enable/Disable the RAM logging service.
Minimum Severity	The minimum severity for the RAM logging.
Flash Logging	
State	Enable/Disable the flash logging service.
Minimum Severity	The minimum severity for the flash logging.

IV-13-1-2. Remote Server

To configure the remote logging server, click **Diagnostic > Logging > Remote Server**.

Remote Server Table

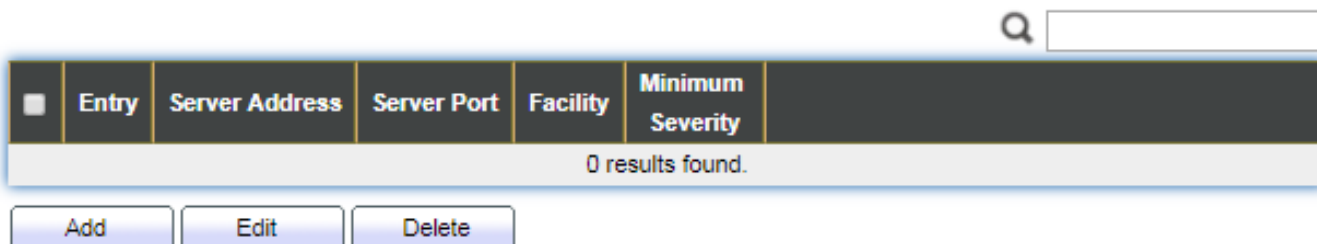

0 results found.

Add Edit Delete

Item	Description
Server Address	The IP address of the remote logging server.
Server Ports	The port number of the remote logging server.
Facility	The facility of the logging messages. It can be one of the following values: local0, local1, local2, local3, local4, local5, local6, and local7.
Minimum Severity	<ul style="list-style-type: none">● Emergence: System is not usable.● Alert: Immediate action is needed.● Critical: System is in the critical condition.● Error: System is in error condition● Warning: System warning has occurred● Notice: System is functioning properly, but a system notice has occurred.● Informational: Device information.● Debug: Provides detailed information about an event.

IV-13-2. Mirroring

To display Port Mirroring web page, click **Diagnostics > Mirroring**.

Mirroring Table

Q

	Session ID	State	Monitor Port	Ingress Port	Egress Port
<input type="radio"/>	1	Disabled	---	---	---
<input type="radio"/>	2	Disabled	---	---	---
<input type="radio"/>	3	Disabled	---	---	---
<input type="radio"/>	4	Disabled	---	---	---

*** Allow the monitor port to send or receive normal packets

Item	Description
Session ID	Select mirror session ID.
State	Select mirror session state : port-base mirror or disable <ul style="list-style-type: none"> ● Enabled: Enable port based mirror ● Disabled: Disable mirror.
Monitor Port	Select mirror session monitor port, and select whether normal packet could be sent or received by monitor port.
Ingress port	Select mirror session source rx ports.
Egress port	Select mirror session source tx ports.

Click "**Edit**" button to view the Edit Mirroring menu.

Edit Mirroring

Session ID	1				
State	<input type="checkbox"/> Enable				
Monitor Port	GE1 ▾ <input type="checkbox"/> Send or Receive Normal Packet				
Ingress Port	<table border="1"> <tr> <th>Available Port</th> <th>Selected Port</th> </tr> <tr> <td>GE1 GE2 GE3 GE4 GE5 GE6 GE7 GE8</td> <td></td> </tr> </table>	Available Port	Selected Port	GE1 GE2 GE3 GE4 GE5 GE6 GE7 GE8	
Available Port	Selected Port				
GE1 GE2 GE3 GE4 GE5 GE6 GE7 GE8					
Egress Port	<table border="1"> <tr> <th>Available Port</th> <th>Selected Port</th> </tr> <tr> <td>GE1 GE2 GE3 GE4 GE5 GE6 GE7 GE8</td> <td></td> </tr> </table>	Available Port	Selected Port	GE1 GE2 GE3 GE4 GE5 GE6 GE7 GE8	
Available Port	Selected Port				
GE1 GE2 GE3 GE4 GE5 GE6 GE7 GE8					

Apply Close

Item	Description
Session ID	Selected mirror session ID.
State	Select mirror session state : port-base mirror or disable <ul style="list-style-type: none"> ● Enabled: Enable port based mirror ● Disabled: Disable mirror.
Monitor Port	Select mirror session monitor port, and select whether normal packet could be sent or received by monitor port.
Ingress port	Select mirror session source rx ports.
Egress port	Select mirror session source tx ports.

IV-13-3. Ping

For the ping functionality, click **Diagnostic > Ping**.

Address Type	<input checked="" type="radio"/> Hostname <input type="radio"/> IPv4 <input type="radio"/> IPv6
Server Address	<input type="text"/>
Count	<input type="checkbox"/> User Defined <input type="text" value="4"/> Sec (1 - 65535)

Ping Result

Packet Status	
Status	N/A
Transmit Packet	0
Receive Packet	0
Packet Lost	0%
Round Trip Time	
Min	0.0 ms
Max	0.0 ms
Average	0.0 ms

Item	Description
Address Type	Specify the address type to "Hostname" or "IPv4".
Server Address	Specify the Hostname/IPv4 address for the remote logging server.
Count	Specify the numbers of each ICMP ping request.

IV-13-4. Traceroute

For trace route functionality, click **Diagnostic > Traceroute**.

Address Type	<input checked="" type="radio"/> Hostname <input type="radio"/> IPv4
Server Address	<input type="text"/>
Time to Live	<input type="checkbox"/> User Defined <input type="text" value="30"/> (2 - 255, default 30)

Traceroute Result

Item	Description
Address Type	Specify the address type to “Hostname” or “IPv4”.
Server Address	Specify the Hostname/IPv4 address for the remote logging server.
Time to Live	Specify the max hops of hosts for traceroute.

IV-13-5. Copper Test

For copper length diagnostic, click **Diagnostic > Copper Test**.

Port GE1 ▼

Copper Test

Copper Test Result

Cable Status	
Port	N/A
Result	N/A
Length	N/A

Item	Description
Port	Specify the interface for the copper test.
Copper Test Result	
Port	The interface for the copper test.
Result	The status of copper test. It include: <ul style="list-style-type: none">● OK: Correctly terminated pair.● Short Cable: Shorted pair.● Open Cable: Open pair, no link partner.● Impedance Mismatch: Terminating impedance is not in the reference range.
Length	Distance in meter from the port to the location on the cable where the fault was discovered.

IV-13-6. Fiber Module

The Optical Module Status page displays the operational information reported by the Small Form-factor Pluggable (SFP) transceiver. Some information may not be available for SFPs without the supports of digital diagnostic monitoring standard SFF-8472.

To display the Optical Module Diagnostic page, click **Diagnostic > Fiber Module**.

Fiber Module Table

	Port	Temperature (C)	Voltage (V)	Current (mA)	Output Power (mW)	Input Power (mW)	OE Present	Loss of Signal
<input type="radio"/>	GE25	N/A	N/A	N/A	N/A	N/A	Remove	Loss
<input type="radio"/>	GE26	N/A	N/A	N/A	N/A	N/A	Remove	Loss
<input type="radio"/>	GE27	N/A	N/A	N/A	N/A	N/A	Remove	Loss
<input type="radio"/>	GE28	N/A	N/A	N/A	N/A	N/A	Remove	Loss

Item	Description
Port	Interface or port number.
Temperature	Internally measured transceiver temperature.
Voltage	Internally measured supply voltage.
Current	Measured TX bias current.
Output Power	Measured TX output power in milliwatts.
Input Power	Measured RX received power in milliwatts.
Transmitter Fault	State of TX fault.
OE Present	Indicate transceiver has achieved power up and data is ready.
Loss of Signal	Loss of signal.
Refresh	Refresh the page.
Detail	The detail information on the specified port.

Click "**Detail**" button to view the Fiber Module Status menu.

Fiber Module Status

Port	GE25
OE Present	N/A
Loss of Signal	N/A
Transceiver Type	N/A
Connector Type	N/A
Ethernet Compliance Code	N/A
Transmission Media	N/A
Wavelength	N/A
Bitrate	N/A
Vendor OUI	N/A
Vendor Name	N/A
Vendor PN	N/A
Vendor Revision	N/A
Vendor SN	N/A
Date Code	N/A
Temperature (C)	N/A
Voltage (V)	N/A
Current (mA)	N/A
Output Power (mW)	N/A
Input Power (mW)	N/A

Refresh

Close

IV-13-7. UDLD

Use the UDLD pages to configure settings of UDLD function.

IV-13-7-1. Property

This page allow user to configure global and per interface settings of UDLD.

To display Property page, click **Diagnostics > UDLD > Property.**

Message Time Sec (1 - 90, default 15)

Apply

Entry	Port	Mode	Bidirectional State	Operational Status	Neighbor	
<input type="checkbox"/>	1	GE1	Disabled	Unknown	0	
<input type="checkbox"/>	2	GE2	Disabled	Unknown	0	
<input type="checkbox"/>	3	GE3	Disabled	Unknown	0	
<input type="checkbox"/>	4	GE4	Disabled	Unknown	0	
<input type="checkbox"/>	5	GE5	Disabled	Unknown	0	
<input type="checkbox"/>	6	GE6	Disabled	Unknown	0	
<input type="checkbox"/>	7	GE7	Disabled	Unknown	0	
<input type="checkbox"/>	8	GE8	Disabled	Unknown	0	
<input type="checkbox"/>	9	GE9	Disabled	Unknown	0	
<input type="checkbox"/>	10	GE10	Disabled	Unknown	0	
<input type="checkbox"/>	11	GE11	Disabled	Unknown	0	
<input type="checkbox"/>	12	GE12	Disabled	Unknown	0	
<input type="checkbox"/>	13	GE13	Disabled	Unknown	0	
<input type="checkbox"/>	14	GE14	Disabled	Unknown	0	
<input type="checkbox"/>	15	GE15	Disabled	Unknown	0	
<input type="checkbox"/>	16	GE16	Disabled	Unknown	0	
<input type="checkbox"/>	17	GE17	Disabled	Unknown	0	
<input type="checkbox"/>	18	GE18	Disabled	Unknown	0	
<input type="checkbox"/>	19	GE19	Normal	Unknown	Link down	0
<input type="checkbox"/>	20	GE20	Normal	Unknown	Link down	0
<input type="checkbox"/>	21	GE21	Disabled	Unknown	0	
<input type="checkbox"/>	22	GE22	Disabled	Unknown	0	
<input type="checkbox"/>	23	GE23	Disabled	Unknown	0	
<input type="checkbox"/>	24	GE24	Disabled	Unknown	0	
<input type="checkbox"/>	25	XGE1	Disabled	Unknown	0	
<input type="checkbox"/>	26	XGE2	Disabled	Unknown	0	
<input type="checkbox"/>	27	XGE3	Disabled	Unknown	0	
<input type="checkbox"/>	28	XGE4	Disabled	Unknown	0	

Edit

Item	Description
Message Time	Input the interval for sending message. Range is 1 -90 seconds.
Port	Display port ID of entry.
Mode	Display UDLD running mode of interface.
Bidirectional State	Display bidirectional state of interface.
Operational Status	Display operational status of interface.
Neighbor	Display the number of neighbor of interface.

Click "**Edit**" button to view the Fiber Module Status menu.

Edit Port Setting

Port GE1

Mode

- Disabled
- Normal
- Aggressive

Apply

Close

Item	Description
Port	Display selected port to be edited.
Mode	Select UDLD running mode of interface. <ul style="list-style-type: none"> ● Disabled: Disable UDLD function. ● Normal: Running on normal mode that port goes to Link Up One phase after last neighbor ages out. ● Aggressive: Running on aggressive mode that port goes to Re-Establish phase after last neighbor ages out.

IV-13-7-2. Neighbor

To display Neighbor page, click **Diagnostics > UDLD > Neighbor**.

Neighbor Table

Entry	Expiration Time	Current Neighbor State	Device ID	Device Name	Port ID	Message Interval	Timeout Interval
0 results found.							

Item	Description
Entry	Display entry index.
Expiration Time	Display expiration time before age out.
Current Neighbor State	Display neighbor current state.
Device ID	Display neighbor device ID.
Device Name	Display neighbor device name.
Port ID	Display neighbor port ID that connected.
Message Interval	Display neighbor message interval.
Timeout Interval	Display neighbor timeout interval.

IV-14. Management

Use the Management pages to configure settings for the switch management features.

IV-14-1. User Account

The default username/password is admin/admin. And default account is not able to be deleted.

Use this page to add additional users that are permitted to manage the switch or to change the passwords of existing users.

To display User Account web page, click **Management > User Account**.

User Account

Showing entries Showing 1 to 1 of 1 entries

<input type="checkbox"/>	Username	Privilege
<input type="checkbox"/>	admin	Admin

Item	Description
Username	User name of the account.
Privilege	Select privilege level for new account. <ul style="list-style-type: none">● Admin: Allow to change switch settings. Privilege value equals to 15.● User: See switch settings only. Not allow to change it. Privilege level equals to 1.

Click "**Add**" or "**Edit**" button to view the Add/Edit User Account menu.

Add User Account

Username	<input type="text"/>
Password	<input type="password"/>
Confirm Password	<input type="password"/>
Privilege	<input checked="" type="radio"/> Admin <input type="radio"/> User

Edit User Account

Username	admin
Password	<input type="password"/>
Confirm Password	<input type="password"/>
Privilege	<input checked="" type="radio"/> Admin <input type="radio"/> User

Item	Description
Username	User name of the account.
Password	Set password of the account.
Confirm Password	Set the same password of the account as in "Password" field.
Privilege	Select privilege level for new account. <ul style="list-style-type: none">● Admin: Allow to change switch settings. Privilege value equals to 15.● User: See switch settings only. Not allow to change it. Privilege level equals to 1.

IV-14-2. Firewall

IV-14-2-1. Upgrade / Backup

This page allow user to upgrade or backup firmware image through HTTP or TFTP server.

To display firmware upgrade or backup web page, click **Management > Firmware > Upgrade/Backup**.

The screenshot shows a web form for configuring firmware operations. It is divided into three sections: Action, Method, and Filename. The Action section has radio buttons for 'Upgrade' (selected) and 'Backup'. The Method section has radio buttons for 'TFTP' and 'HTTP' (selected). The Filename section contains a 'Choose File' button and a text box displaying 'No file chosen'. Below the form is an 'Apply' button.

Item	Description
Action	Firmware operations <ul style="list-style-type: none">● Upgrade: Upgrade firmware from remote host to DUT.● Backup: Backup firmware image from DUT to remote host.
Method	Firmware upgrade / backup method. <ul style="list-style-type: none">● TFTP: Using TFTP to upgrade/backup firmware.● HTTP: Using WEB browser to upgrade/backup firmware.
Filename	Use browser to upgrade firmware, you should select firmware image file on your host PC.

To display firmware upgrade or backup web page, click **Management > Firmware > Upgrade/Backup**.

Active Image

Image0
 Image1

Note: the image was selected for the next boot

Active Image

Firmware	Image1
Version	1.00.07
Name	Edimax_PG28CB_V1.00.07_r380_vmlinux_web.bix
Size	6417775 Bytes
Created	2017-11-21 14:54:59

Backup Image

Firmware	Image0
Version	1.00.06
Name	Edimax_PG28CB_V1.00.06_r373_vmlinux_web.bix
Size	6413996 Bytes
Created	2017-11-08 20:00:06

Item	Description
Action	Firmware operations <ul style="list-style-type: none"> ● Upgrade: Upgrade firmware from remote host to DUT ● Backup: Backup firmware image from DUT to remote host
Method	Firmware upgrade / backup method <ul style="list-style-type: none"> ● TFTP: Using TFTP to upgrade/backup firmware. ● HTTP: Using WEB browser to upgrade/backup firmware.
Address Type	Specify TFTP server address type <ul style="list-style-type: none"> ● Hostname: Use domain name as server address ● IPv4: Use IPv4 as server address ● IPv6: Use IPv6 as server address
Server Address	Specify TFTP server address.
Filename	Firmware image file name on remote TFTP server

To display firmware upgrade or backup web page, click **Management > Firmware > Upgrade/Backup**.

The screenshot shows a configuration panel with three sections: Action, Method, and Firmware. Each section has a label and two radio button options. Below the sections is an 'Apply' button.

Action	<input type="radio"/> Upgrade <input checked="" type="radio"/> Backup
Method	<input type="radio"/> TFTP <input checked="" type="radio"/> HTTP
Firmware	<input checked="" type="radio"/> Image0 <input type="radio"/> Image1

Apply

Item	Description
Action	Firmware operations <ul style="list-style-type: none"> ● Upgrade: Upgrade firmware from remote host to DUT ● Backup: Backup firmware image from DUT to remote host
Method	Firmware upgrade / backup method <ul style="list-style-type: none"> ● TFTP: Using TFTP to upgrade/backup firmware. ● HTTP: Using WEB browser to upgrade/backup firmware.
Firmware	Firmware partition need to backup <ul style="list-style-type: none"> ● Image0: Firmware image in flash partition 0 ● Image1: Firmware image in flash partition 1

To display the Firmware Upgrade/Backup web page, click **Management > Firmware > Upgrade/Backup**.

The screenshot shows a configuration panel with six sections: Action, Method, Firmware, Address Type, Server Address, and Filename. Each section has a label and radio button options, except for Server Address and Filename which are text input fields. Below the sections is an 'Apply' button.

Action	<input type="radio"/> Upgrade <input checked="" type="radio"/> Backup
Method	<input checked="" type="radio"/> TFTP <input type="radio"/> HTTP
Firmware	<input checked="" type="radio"/> Image0 <input type="radio"/> Image1
Address Type	<input checked="" type="radio"/> Hostname <input type="radio"/> IPv4 <input type="radio"/> IPv6
Server Address	<input type="text"/>
Filename	<input type="text"/>

Apply

Item	Description
Action	Firmware operations <ul style="list-style-type: none"> ● Upgrade: Upgrade firmware from remote host to DUT ● Backup: Backup firmware image from DUT to remote host
Method	Firmware upgrade / backup method <ul style="list-style-type: none"> ● TFTP: Using TFTP to upgrade/backup firmware. ● HTTP: Using WEB browser to upgrade/backup firmware.
Firmware	Firmware partition need to backup <ul style="list-style-type: none"> ● Image0: Firmware image in flash partition 0. ● Image1: Firmware image in flash partition 1.
Address Type	Specify TFTP server address type <ul style="list-style-type: none"> ● Hostname: Use domain name as server address. ● IPv4: Use IPv4 as server address. ● IPv6: Use IPv6 as server address.
Server Address	Specify TFTP server address address.
Filename	File name saved on remote TFTP server.

IV-14-2-2. Active Image

This page allow user to select firmware image on next booting and show firmware information on both flash partitions.

To display the Active Image web page, click **Management > Firmware > Active Image**.

Active Image

Image0
 Image1

Note: the image was selected for the next boot

Active Image

Firmware	Image1
Version	1.00.07
Name	Edimax_PG28CB_V1.00.07_r380_vmlinux_web.bix
Size	6417775 Bytes
Created	2017-11-21 14:54:59

Backup Image

Firmware	Image0
Version	1.00.06
Name	Edimax_PG28CB_V1.00.06_r373_vmlinux_web.bix
Size	6413996 Bytes
Created	2017-11-08 20:00:06

Item	Description
Active Image	Select firmware image to use on next booting
Firmware	Firmware flash partition name.
Version	Firmware version.
Name	Firmware name.
Size	Firmware image size.
Created	Firmware image created date.

IV-14-3. Configuration

IV-14-3-1. Upgrade / Backup

This page allow user to upgrade or backup configuration file through HTTP or TFTP server.

To display firmware upgrade or backup web page, click **Management > Configuration > Upgrade/Backup**.

The screenshot shows a web form for configuration operations. It is divided into four sections by dashed lines:

- Action:** Radio buttons for 'Upgrade' (selected) and 'Backup'.
- Method:** Radio buttons for 'TFTP' and 'HTTP' (selected).
- Configuration:** Radio buttons for 'Running Configuration' (selected), 'Startup Configuration', 'Backup Configuration', 'RAM Log', and 'Flash Log'.
- Filename:** A 'Choose File' button and a text box containing 'No file chosen'.

Below the form is an 'Apply' button.

Item	Description
Action	Configuration operations <ul style="list-style-type: none"> ● Upgrade: Upgrade firmware from remote host to DUT ● Backup: Backup firmware image from DUT to remote host
Method	Configuration upgrade / backup method <ul style="list-style-type: none"> ● TFTP: Using TFTP to upgrade/backup firmware ● HTTP: Using WEB browser to upgrade/backup firmware
Configuration	Configuration types <ul style="list-style-type: none"> ● Running Configuration: Merge to current running configuration file ● Startup Configuration: Replace startup configuration file ● Backup Configuration: Replace backup configuration file
Filename	Use browser to upgrade configuration, you should select configuration file on your host PC.

To display firmware upgrade or backup web page, click **Management > Configuration > Upgrade/Backup**.

Item	Description
Action	Configuration operations <ul style="list-style-type: none"> ● Upgrade: Upgrade firmware from remote host to DUT ● Backup: Backup firmware image from DUT to remote host
Method	Configuration upgrade / backup method <ul style="list-style-type: none"> ● TFTP: Using TFTP to upgrade/backup firmware ● HTTP: Using WEB browser to upgrade/backup firmware
Configuration	Configuration types <ul style="list-style-type: none"> ● Running Configuration: Merge to current running configuration file ● Startup Configuration: Replace startup configuration file ● Backup Configuration: Replace backup configuration file
Address Type	Specify TFTP server address type <ul style="list-style-type: none"> ● Hostname: Use domain name as server address ● IPv4: Use IPv4 as server address ● IPv6: Use IPv6 as server address
Server Address	Specify TFTP server address address
Filename	File name saved on remote TFTP server

To display firmware upgrade or backup web page, click **Management > Configuration > Upgrade/Backup**.

The screenshot shows a configuration interface with three sections: Action, Method, and Configuration. Each section contains radio button options. The 'Action' section has 'Upgrade' and 'Backup' (selected). The 'Method' section has 'TFTP' and 'HTTP' (selected). The 'Configuration' section has 'Running Configuration', 'Startup Configuration', 'Backup Configuration', 'RAM Log', and 'Flash Log' (with 'Running Configuration' selected). An 'Apply' button is positioned below the configuration options.

Item	Description
Action	Configuration operations <ul style="list-style-type: none"> ● Upgrade: Upgrade firmware from remote host to DUT ● Backup: Backup firmware image from DUT to remote host
Method	Configuration upgrade / backup method <ul style="list-style-type: none"> ● TFTP: Using TFTP to upgrade/backup firmware ● HTTP: Using WEB browser to upgrade/backup firmware
Configuration	Configuration types <ul style="list-style-type: none"> ● Running Configuration: Backup running configuration file. ● Startup Configuration: Backup start configuration file. ● Backup Configuration: Backup backup configuration file. ● RAM Log: Backup log file stored in RAM. ● Flash Log: Backup log files store in Flash.

To display firmware upgrade or backup web page, click **Management > Configuration > Upgrade/Backup**

The screenshot shows a configuration interface for firmware upgrade or backup. It features several sections with radio button options and text input fields:

- Action:** Radio buttons for Upgrade (selected) and Backup.
- Method:** Radio buttons for TFTP (selected) and HTTP.
- Configuration:** Radio buttons for Running Configuration (selected), Startup Configuration, Backup Configuration, RAM Log, and Flash Log.
- Address Type:** Radio buttons for Hostname (selected), IPv4, and IPv6.
- Server Address:** A text input field.
- Filename:** A text input field.

An **Apply** button is located below the configuration fields.

Item	Description
Action	Configuration operations <ul style="list-style-type: none"> ● Upgrade: Upgrade firmware from remote host to DUT ● Backup: Backup firmware image from DUT to remote host
Method	Configuration upgrade / backup method <ul style="list-style-type: none"> ● TFTP: Using TFTP to upgrade/backup firmware ● HTTP: Using WEB browser to upgrade/backup firmware
Configuration	Configuration types <ul style="list-style-type: none"> ● Running Configuration: Backup running configuration file. ● Startup Configuration: Backup start configuration file. ● Backup Configuration: Backup backup configuration file. ● RAM Log: Backup log file stored in RAM. ● Flash Log: Backup log files store in Flash.
Address Type	Specify TFTP server address type <ul style="list-style-type: none"> ● Hostname: Use domain name as server address ● IPv4: Use IPv4 as server address ● IPv6: Use IPv6 as server address
Server Address	Specify TFTP server address address.
Filename	File name saved on remote TFTP server.

IV-14-3-2. Save Configuration

This page allow user to manage configuration file saved on DUT and click “**Restore Factory Default**” button to restore factory defaults.

To display the Save Configuration web page, click **Management > Configuration > Save Configuration**.

The screenshot shows a web interface for saving configuration. It is divided into two main sections: 'Source File' and 'Destination File'. The 'Source File' section has three radio button options: 'Running Configuration' (which is selected), 'Startup Configuration', and 'Backup Configuration'. The 'Destination File' section has two radio button options: 'Startup Configuration' (which is selected) and 'Backup Configuration'. Below these sections are two buttons: 'Apply' and 'Restore Factory Default'.

Item	Description
Source File	Source file types <ul style="list-style-type: none">● Running Configuration: Copy running configuration file to destination.● Startup Configuration: Copy startup configuration file to destination.● Backup Configuration: Copy backup configuration file to destination
Destination File	Destination file <ul style="list-style-type: none">● Startup Configuration: Save file as startup configuration.● Backup Configuration: Save file as backup configuration.

IV-14-4. SNMP

IV-14-4-1. View

To configure and display the SNMP view table, click **Management > SNMP > View**.

View Table

Showing entries Showing 1 to 1 of 1 entries

<input type="checkbox"/>	View	OID Subtree	Type
<input type="checkbox"/>	all	.1	Included

Item	Description
View	The SNMP view name. Its maximum length is 30 characters
OID Subtree	Specify the ASN.1 subtree object identifier (OID) to be included or excluded from the SNMP view
Type	Include or exclude the selected MIBs in the view

IV-14-4-2. Group

To configure and display the SNMP group settings, click **Management > SNMP > Group**.

Group Table

Showing entries Showing 0 to 0 of 0 entries

<input type="checkbox"/>	Group	Version	Security Level	View		
				Read	Write	Notify
0 results found.						

Configure [SNMP View](#) to associate a non-default view with a group.

Item	Description
Group	Specify SNMP group name, and the maximum length is 30 characters.
Version	Specify SNMP version <ul style="list-style-type: none"> ● SNMPv1: SNMP Version 1. ● SNMPv2: Community-based SNMP Version 2. ● SNMPv3: User security model SNMP version 3.
Security Level	Specify SNMP security level <ul style="list-style-type: none"> ● No Security: Specify that no packet authentication is performed. ● Authentication: Specify that no packet authentication without encryption is performed.

	<ul style="list-style-type: none">● Authentication and Privacy: Specify that no packet authentication with encryption is performed.
View	
Read	Group read view name.
Write	Group write view name.
Notify	The view name that sends only traps with contents that is included in SNMP view selected for notification.

Click "**Add**" or "**Edit**" button to view the Add/Edit Group menu.

Add Group

Group	<input type="text"/>
Version	<input checked="" type="radio"/> SNMPv1 <input type="radio"/> SNMPv2 <input type="radio"/> SNMPv3
Security Level	<input checked="" type="radio"/> No Security <input type="radio"/> Authentication <input type="radio"/> Authentication and Privacy
View	<input checked="" type="checkbox"/> Read
	<input type="text" value="all"/> ▼
	<input type="checkbox"/> Write
	<input type="text" value="all"/> ▼
	<input type="checkbox"/> Notify
	<input type="text" value="all"/> ▼

Apply

Close

Edit Group

Group	1
Version	<input checked="" type="radio"/> SNMPv1 <input type="radio"/> SNMPv2 <input type="radio"/> SNMPv3
Security Level	<input checked="" type="radio"/> No Security <input type="radio"/> Authentication <input type="radio"/> Authentication and Privacy
View	<input checked="" type="checkbox"/> Read
	<input type="text" value="all"/> ▼
	<input type="checkbox"/> Write
	<input type="text" value="all"/> ▼
	<input type="checkbox"/> Notify
	<input type="text" value="all"/> ▼

Apply

Close

Item	Description
Group	Specify SNMP group name, and the maximum length is 30 characters.
Version	Specify SNMP version <ul style="list-style-type: none"> ● SNMPv1: SNMP Version 1. ● SNMPv2: Community-based SNMP Version 2.

	<ul style="list-style-type: none"> ● SNMPv3: User security model SNMP version 3.
Security Level	Specify SNMP security level <ul style="list-style-type: none"> ● No Security: Specify that no packet authentication is performed. ● Authentication: Specify that no packet authentication without encryption is performed. ● Authentication and Privacy: Specify that no packet authentication with encryption is performed.
View	
Read	Select read view name if Read is checked.
Write	Select write view name, if Write is checked.
Notify	Select notify view name, if Notify is checked.

IV-14-4-3. Community

To configure and display the SNMP community settings, click **Management > SNMP > Community**.

Community Table

Showing entries Showing 1 to 1 of 1 entries

<input type="checkbox"/>	Community	Group	View	Access
<input type="checkbox"/>	public		all	Read-Write

The access right of a community is defined by a group under advanced mode.
Configure [SNMP Group](#) to associate a group with a community.

Item	Description
Community	The SNMP community name. Its maximum length is 20 characters.
Group	Specify the SNMP group configured by the command snmp group to define the object available to the community.
View	Specify the SNMP view to define the object available to the community.
Access	SNMP access mode <ul style="list-style-type: none"> ● Read-Only: Read only. ● Read-Write: Read and write.

Click "**Add**" or "**Edit**" button to view the Add/Edit Community menu.

Add Community

Community	<input type="text"/>
Type	<input checked="" type="radio"/> Basic <input type="radio"/> Advanced
View	<input type="text" value="all"/> ▼
Access	<input checked="" type="radio"/> Read-Only <input type="radio"/> Read-Write
Group	<input type="text" value="1"/> ▼

Edit Community

Community	public
Type	<input checked="" type="radio"/> Basic <input type="radio"/> Advanced
View	<input type="text" value="all"/> ▼
Access	<input type="radio"/> Read-Only <input checked="" type="radio"/> Read-Write
Group	<input type="text" value="1"/> ▼

Item	Description
Community	The SNMP community name. Its maximum length is 20 characters.
Type	SNMP Community mode <ul style="list-style-type: none"> ● Basic: SNMP community specifies view and access right. ● Advanced: SNMP community specifies group.
View	Specify the SNMP view to define the object available to the community.
Access	SNMP access mode <ul style="list-style-type: none"> ● Read-Only: Read only. ● Read-Write: Read and write.
Group	Specify the SNMP group configured by the command snmp group to define the object available to the community.

IV-14-4-4. User

To configure and display the SNMP users, click **Management > SNMP > User**.

User Table

Showing All entries Showing 0 to 0 of 0 entries

<input type="checkbox"/>	User	Group	Security Level	Authentication Method	Privacy Method
0 results found.					

Configure [SNMP Group](#) to associate an SNMPv3 group with an SNMPv3 user.

Item	Description
User	Specify the SNMP user name on the host that connects to the SNMP agent. The max character is 30 characters. For the SNMP v1 or v2c, the user name must match the community name.
Group	Specify the SNMP group to which the SNMP user belongs.
Security Level	SNMP privilege mode <ul style="list-style-type: none"> ● No Security: Specify that no packet authentication is performed. ● Authentication: Specify that no packet authentication without encryption is performed. ● Authentication and Privacy: Specify that no packet authentication with encryption is performed.
Authentication Method	Authentication Protocol which is available when Privilege Mode is Authentication or Authentication and Privacy. <ul style="list-style-type: none"> ● None: No authentication required. ● MD5: Specify the HMAC-MD5-96 authentication protocol. ● SHA: Specify the HMAC-SHA-96 authentication protocol
Privacy Method	Encryption Protocol <ul style="list-style-type: none"> ● None: No privacy required. ● DES: DES algorithm

Click "**Add**" or "**Edit**" button to view Add/Edit User menu.

Add User

User	<input type="text"/>
Group	11 ▼
Security Level	<input checked="" type="radio"/> No Security <input type="radio"/> Authentication <input type="radio"/> Authentication and Privacy
Authentication	
Method	<input checked="" type="radio"/> None <input type="radio"/> MD5 <input type="radio"/> SHA
Password	<input type="password"/>
Privacy	
Method	<input checked="" type="radio"/> None <input type="radio"/> DES
Password	<input type="password"/>

Edit User

User	22
Group	11 ▼
Security Level	<input checked="" type="radio"/> No Security <input type="radio"/> Authentication <input type="radio"/> Authentication and Privacy
Authentication	
Method	<input checked="" type="radio"/> None <input type="radio"/> MD5 <input type="radio"/> SHA
Password	<input type="password"/>
Privacy	
Method	<input checked="" type="radio"/> None <input type="radio"/> DES
Password	<input type="password"/>

Item	Description
User	Specify the SNMP user name on the host that connects to the SNMP agent. The max character is 30 characters.
Group	Specify the SNMP group to which the SNMP user belongs.
Security Level	SNMP privilege mode <ul style="list-style-type: none"> ● No Security: Specify that no packet authentication is performed. ● Authentication: Specify that no packet authentication without encryption is performed. ● Authentication and Privacy: Specify that no packet authentication with encryption is performed.
Authentication	
Method	Authentication Protocol which is available when Privilege Mode is Authentication or Authentication and Privacy. <ul style="list-style-type: none"> ● None: No authentication required. ● MD5: Specify the HMAC-MD5-96 authentication protocol. ● SHA: Specify the HMAC-SHA-96 authentication protocol.
Password	The authentication password, The number of character range is 8 to 32 characters.
Privacy	
Method	Encryption Protocol <ul style="list-style-type: none"> ● None: No privacy required. ● DES: DES algorithm
Password	The privacy password, The number of character range is 8 to 64 characters.

IV-14-4-5. Engine ID

To configure and display SNMP local and remote engine ID, click **Management > SNMP > Engine ID**.

Local Engine ID

User Defined

Engine ID: (10 - 64 Hexadecimal Characters)

Apply

Remote Engine ID Table

Showing **All** entries

Showing 0 to 0 of 0 entries

Server Address	Engine ID
0 results found.	

Item	Description
Local Engine ID	
Engine ID	<p>If checked "User Defined", the local engine ID is configure by user, else use the default Engine ID which is made up of MAC and Enterprise ID.</p> <p>The user defined engine ID is range 10 to 64 hexadecimal characters, and the hexadecimal number must be divided by 2.</p>
Remote Engine ID Table	
Table	
Server Address	Remote host.
Engine ID	Specify Remote SNMP engine ID. The engine ID is range10 to 64 hexadecimal characters, and the hexadecimal number must be divided by 2.

Click "**Add**" button to view Add Remote Engine ID menu.

Add Remote Engine ID

Item	Description
Address Type	Remote host address type for Hostname/IPv4/IPv6.
Server Address	Remote host.
Engine ID	Specify Remote SNMP engine ID. The engine ID is range10 to 64 hexadecimal characters, and the hexadecimal number must be divided by 2.

Click "**Edit**" button to view Edit Remote Engine ID menu.

Edit Remote Engine ID

Item	Description
Server Address	Edit Remote host address
Engine ID	Specify Remote SNMP engine ID. The engine ID is range10 to 64 hexadecimal characters, and the hexadecimal number must be divided by 2.

IV-14-4-6. Trap Event

To configure and display SNMP trap event, click **Management > SNMP > Trap Event**.

Authentication Failure	<input checked="" type="checkbox"/> Enable
Link Up / Down	<input checked="" type="checkbox"/> Enable
Cold Start	<input checked="" type="checkbox"/> Enable
Warm Start	<input checked="" type="checkbox"/> Enable

Apply

Item	Description
Authentication Failure	SNMP authentication failure trap, when community not match or user authentication password not match.
Link Up/Down	Port link up or down trap.
Cold Start	Device reboot configure by user trap.
Warm Start	Device reboot by power down trap.

IV-14-4-7. Notification

To configure the hosts to receive SNMPv1/v2/v3 notification, click **Management > SNMP > Notification**.

Notification Table

Showing **All** entries

Showing 0 to 0 of 0 entries

<input type="checkbox"/>	Server Address	Server Port	Timeout	Retry	Version	Type	Community / User	Security Level
0 results found.								

First Previous 1 Next Last

For SNMPv1,2 Notification, [SNMP Community](#) needs to be defined.
For SNMPv3 Notification, [SNMP User](#) must be created.

Item	Description
Server Address	IP address or the hostname of the SNMP trap recipients.
Server Port	Recipients server UDP port number.
Timeout	Specify the SNMP informs timeout.
Retry	Specify the retry counter of the SNMP informs.

Version	Specify SNMP notification version <ul style="list-style-type: none"> ● SNMPv1: SNMP Version 1 notification. ● SNMPv2: SNMP Version 2 notification. ● SNMPv3: SNMP Version 3 notification.
Type	Notification Type <ul style="list-style-type: none"> ● Trap: Send SNMP traps to the host. ● Inform: Send SNMP informs to the host.
Community/User	SNMP community/user name for notification. If version is SNMPv3 the name is user name, else is community name.
UDP Port	Specify the UDP port number.
Timeout	Specify the SNMP informs timeout.
Security Level	SNMP trap packet security level <ul style="list-style-type: none"> ● No Security: Specify that no packet authentication is performed. ● Authentication: Specify that no packet authentication without encryption is performed. ● Authentication and Privacy: Specify that no packet authentication with encryption is performed.

Click "**Add**" button to view the Notification menu.

Add Notification

Address Type	<input checked="" type="radio"/> Hostname <input type="radio"/> IPv4 <input type="radio"/> IPv6
Server Address	<input type="text"/>
Version	<input checked="" type="radio"/> SNMPv1 <input type="radio"/> SNMPv2 <input type="radio"/> SNMPv3
Type	<input checked="" type="radio"/> Trap <input type="radio"/> Inform
Community / User	<input type="text" value="public"/>
Security Level	<input checked="" type="radio"/> No Security <input type="radio"/> Authentication <input type="radio"/> Authentication and Privacy
Server Port	<input checked="" type="checkbox"/> Use Default <input type="text" value="162"/> (1 - 65535, default 162)
Timeout	<input checked="" type="checkbox"/> Use Default <input type="text" value="15"/> Sec (1 - 300, default 15)
Retry	<input checked="" type="checkbox"/> Use Default <input type="text" value="3"/> (1 - 255, default 3)

Apply

Close

Item	Description
Address Type	Notify recipients host address type.
Server Address	IP address or the hostname of the SNMP trap recipients.
Version	Specify SNMP notification version <ul style="list-style-type: none"> ● SNMPv1: SNMP Version 1 notification. ● SNMPv2: SNMP Version 2 notification. ● SNMPv3: SNMP Version 3 notification.
Type	Notification Type <ul style="list-style-type: none"> ● Trap: Send SNMP traps to the host. ● Inform: Send SNMP informs to the host.(version 1 have no inform)
Community/User	SNMP community/user name for notification. If version is SNMPv3 the name is user name, else is community name.
Security Level	SNMP notification packet security level, the security level must less than or equal to the community/user name <ul style="list-style-type: none"> ● No Security: Specify that no packet authentication is performed. ● Authentication: Specify that no packet authentication

	<p>without encryption is performed.</p> <ul style="list-style-type: none"> ● Authentication and Privacy: Specify that no packet authentication with encryption is performed.
Server Port	Recipients server UDP port number, if “use default” checked the value is 162, else user configure.
Timeout	Specify the SNMP informs timeout, if “use default” checked the value is 15, else user configure.
Retry	Specify the SNMP informs retry count, if “use default” checked the value is 3, else user configure.

Click "Edit" button to view the Edit Notification menu.

Edit Notification

Server Address	123.4.5.6
Version	<input checked="" type="radio"/> SNMPv1 <input type="radio"/> SNMPv2 <input type="radio"/> SNMPv3
Type	<input checked="" type="radio"/> Trap <input type="radio"/> Inform
Community / User	public ▼
Security Level	<input checked="" type="radio"/> No Security <input type="radio"/> Authentication <input type="radio"/> Authentication and Privacy
Server Port	<input checked="" type="checkbox"/> Use Default <input type="text" value="162"/> (1 - 65535, default 162)
Timeout	<input checked="" type="checkbox"/> Use Default <input type="text" value="15"/> Sec (1 - 300, default 15)
Retry	<input checked="" type="checkbox"/> Use Default <input type="text" value="3"/> (1 - 255, default 3)

Apply Close

Item	Description
Server Address	Edit SNMP notify recipients address
Version	Specify SNMP notification version <ul style="list-style-type: none"> ● SNMPv1: SNMP Version 1 notification. ● SNMPv2: SNMP Version 2 notification. ● SNMPv3: SNMP Version 3 notification.
Type	Notification Type <ul style="list-style-type: none"> ● Trap: Send SNMP traps to the host. ● Inform: Send SNMP informs to the host.(version 1 have no inform)
Community/User	SNMP community/user name for notification. If version is SNMPv3 the name is user name, else is community name.
Community Level	SNMP notification packet security level, the security level must less than or equal to the community/user name <ul style="list-style-type: none"> ● No Security: Specify that no packet authentication is performed. ● Authentication: Specify that no packet authentication without encryption is performed. ● Authentication and Privacy: Specify that no packet

	authentication with encryption is performed.
Server Port	Recipients server UDP port number, if “use default” checked the value is 162, else user configure.
Timeout	Specify the SNMP informs timeout, if “use default” checked the value is 15, else user configure.
Retry	Specify the SNMP informs retry count, if “use default” checked the value is 3, else user configure.

IV-14-5. Time Range

This page shows the information of days, start time and end time of the time range.

Time Range

Range Name	Days	Start Time	End Time
<input type="checkbox"/> time-1	Mon, Tue, Wed, Thu, Fri, Sat, Sun	01:00	11:30

To view the Time Range Edit page, please click the ‘Edit’ button.

Time Range Edit

Range Name	<input type="text" value="time-1"/>
Date	<input checked="" type="checkbox"/> Mon <input checked="" type="checkbox"/> Tue <input checked="" type="checkbox"/> Wed <input checked="" type="checkbox"/> Thu <input checked="" type="checkbox"/> Fri <input checked="" type="checkbox"/> Sat <input checked="" type="checkbox"/> Sun
	From <input type="text" value="01:00"/> to <input type="text" value="11:30"/>

V. More Information

For detailed instructions, you can find user manual and all supporting documents from the link below or via the QR code:

<https://www.edimax.com/download/>



Please search the model number to enter the referred page.

Download

To select your product and find related download materials, enter the model number into the search box on the right side or follow the simple steps below:

*Feel free to contact us anytime if you need help or if you can't find your product.

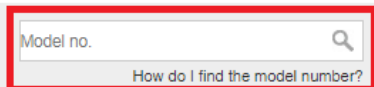

VI. Safety Instructions

The following general safety guidelines are provided to help ensure your own personal safety and protect your product from potential damage. Remember to consult the product user instructions for more details.

- This product is designed for indoor use only.
- Static electricity can be harmful to electronic components. Discharge static electricity from your body (i.e. touching grounded bare metal) before touching the product.
- The device contains no user serviceable parts. Do not attempt to service the product and never disassemble the product.
- Do not spill food or liquid on your product and never push any objects into the openings of your product.
- Do not use this product near water, areas with high humidity, or condensation.
- Keep the product away from radiators and other heat sources.
- This device is not designed to be operated by children.
- Always unplug the product from mains power before cleaning and use a dry lint free cloth only.

COPYRIGHT

Copyright © Edimax Technology Co., Ltd. all rights reserved. No part of this publication may be reproduced, transmitted, transcribed, stored in a retrieval system, or translated into any language or computer language, in any form or by any means, electronic, mechanical, magnetic, optical, chemical, manual or otherwise, without the prior written permission from Edimax Technology Co., Ltd.

Edimax Technology Co., Ltd. makes no representations or warranties, either expressed or implied, with respect to the contents hereof and specifically disclaims any warranties, merchantability, or fitness for any particular purpose. Any software described in this manual is sold or licensed as is. Should the programs prove defective following their purchase, the buyer (and not this company, its distributor, or its dealer) assumes the entire cost of all necessary servicing, repair, and any incidental or consequential damages resulting from any defect in the software. Edimax Technology Co., Ltd. reserves the right to revise this publication and to make changes from time to time in the contents hereof without the obligation to notify any person of such revision or changes.

The product you have purchased and the setup screen may appear slightly different from those shown in this QIG. The software and specifications are subject to change without notice. Please visit our website www.edimax.com for updates. All brand and product names mentioned in this manual are trademarks and/or registered trademarks of their respective holders.

Federal Communication Commission Interference Statement

This equipment has been tested and found to comply with the limits for a Class A digital device, pursuant to Part 15 of the FCC Rules. These limits are designed to provide reasonable protection against harmful interference when the equipment is operated in a commercial environment. This equipment generates, uses, and can radiate radio frequency energy and, if not installed and used in accordance with the instruction manual, may cause harmful interference to radio communications. Operation of this equipment in a residential area is likely to cause harmful interference in which case the user will be required to correct the interference at his own expense.

FCC Radiation Exposure Statement

This device complies with FCC radiation exposure limits set forth for an uncontrolled environment and it also complies with Part 15 of the FCC RF Rules. This equipment must be installed and operated in accordance with provided instructions and the antenna(s) used for this transmitter must be installed to provide a separation distance of at least 20 cm from all persons and must not be co-located or operating in conjunction with any other antenna or transmitter. End-users and installers must be provided with antenna installation instructions and consider removing the no-collocation statement.

This device complies with Part 15 of the FCC Rules. Operation is subject to the following two conditions:

- (1) this device may not cause harmful interference, and
- (2) this device must accept any interference received, including interference that may cause undesired operation.

Caution!

Any changes or modifications not expressly approved by the party responsible for compliance could void the user's authority to operate the equipment.

R&TTE Compliance Statement

This equipment complies with all the requirements of DIRECTIVE 2014/30/EU OF THE EUROPEAN PARLIAMENT AND THE COUNCIL of March 9, 1999 on radio equipment and telecommunication terminal equipment and the mutual recognition of their conformity (R&TTE). The R&TTE Directive repeals and replaces in the directive 98/13/EEC (Telecommunications Terminal Equipment and Satellite Earth Station Equipment) As of April 8, 2000.

Safety

This equipment is designed with the utmost care for the safety of those who install and use it. However, special attention must be paid to the dangers of electric shock and static electricity when working with electrical equipment. All guidelines of this and of the computer manufacture must therefore be allowed at all times to ensure the safe use of the equipment.

EU Countries Intended for Use

The ETSI version of this device is intended for home and office use in Austria, Belgium, Bulgaria, Croatia, Cyprus, Czech, Denmark, Estonia, Finland, France, Germany, Greece, Hungary, Ireland, Italy, Latvia, Lithuania, Luxembourg, Malta, Netherlands, Poland, Portugal, Romania, Slovakia, Slovenia, Spain, Sweden, Turkey, and United Kingdom. The ETSI version of this device is also authorized for use in EFTA member states: Iceland, Liechtenstein, Norway, and Switzerland.

EU Countries Not Intended for Use

None

EU Declaration of Conformity

- English:** This equipment is in compliance with the essential requirements and other relevant provisions of Directive 2014/30/EU.
- Français:** Cet équipement est conforme aux exigences essentielles et autres dispositions de la directive 2014/30/EU.
- Čeština:** Toto zařízení je v souladu se základními požadavky a ostatními příslušnými ustanoveními směrnic 2014/30/EU.
- Polški:** Urządzenie jest zgodne z ogólnymi wymaganiami oraz szczególnymi warunkami określonymi Dyrektywą UE 2014/30/EU.
- Română:** Acest echipament este în conformitate cu cerințele esențiale și alte prevederi relevante ale Directivei 2014/30/EU.
- Русский:** Это оборудование соответствует основным требованиям и положениям Директивы 2014/30/EU.
- Magyar:** Ez a berendezés megfelel az alapvető követelményeknek és más vonatkozó irányelveknek (2014/30/EU).
- Türkçe:** Bu cihaz 2014/30/EU. direktifleri zorunlu istekler ve diğer hükümlerle ile uyumludur.
- Українська:** Обладнання відповідає вимогам і умовам директиви 2014/30/EU.
- Slovenčina:** Toto zariadenie spĺňa základné požiadavky a ďalšie príslušné ustanovenia smerníc 2014/30/EU.
- Deutsch:** Dieses Gerät erfüllt die Voraussetzungen gemäß den Richtlinien 2014/30/EU.
- Español:** El presente equipo cumple los requisitos esenciales de la Directiva 2014/30/EU.
- Italiano:** Questo apparecchio è conforme ai requisiti essenziali e alle altre disposizioni applicabili della Direttiva 2014/30/EU.
- Nederlands:** Dit apparaat voldoet aan de essentiële eisen en andere van toepassing zijnde bepalingen van richtlijn 2014/30/EU.
- Português:** Este equipamento cumpre os requisitos essenciais da Directiva 2014/30/EU.
- Norsk:** Dette utstyret er i samsvar med de viktigste kravene og andre relevante regler i Direktiv 2014/30/EU.
- Svenska:** Denna utrustning är i överensstämmelse med de väsentliga kraven och övriga relevanta bestämmelser i direktiv 2014/30/EU.
- Dansk:** Dette udstyr er i overensstemmelse med de væsentligste krav og andre relevante forordninger i direktiv 2014/30/EU.
- suomen kieli:** Tämä laite täyttää direktiivien 2014/30/EU. oleelliset vaatimukset ja muut asiaankuuluvat määräykset.

FOR USE IN

AT	BE	BG	CZ	DK	DE				
EE	IE	EL	ES	FR	HR	IT	CY	LV	LT
LU	HU	MT	NL	PL	PT	RO	SI	SK	FI
SE	UK	UK(NI)	TR	IS	LI	NO	CH	RU	UA



WEEE Directive & Product Disposal



At the end of its serviceable life, this product should not be treated as household or general waste. It should be handed over to the applicable collection point for the recycling of electrical and electronic equipment, or returned to the supplier for disposal.

Declaration of Conformity

We, Edimax Technology Co., Ltd., declare under our sole responsibility, that the equipment described below complies with the requirements of the European R&TTE directives.

**Equipment: 54 Gigabit ports Web-Smart Switch with 6 SFP+ 10 Gigabit
Model No.: GS-5654LX**

The following European standards for essential requirements have been followed:

Directives 2014/30/EU

EMC : EN 55032:2015+AC:2016
EN 61000-3-2:2014
N 61000-3-3:2013
EN 55035:2017

Directives 2014/35/EU

Safety (LVD) : IEC 62368-1:2014 (2nd Edition) and/or EN 62368-1:2014+A11:2017

Edimax Technology Europe B.V.
Fijenhof 2,
5652 AE Eindhoven,
The Netherlands

Date & Place of Issue: 30/Nov./2022, Eindhoven

Signature: 

Printed Name: David Huang

Title: Director

a company of:

Edimax Technology Co., Ltd.
No. 278, Xinhua 1st Rd., Neihu Dist.,
Taipei City, Taiwan

Date & Place of Issue: 30/Nov./2022, Taipei

Signature: 

Printed Name: Hunter Chen

Title: Director



Declaration of Conformity

We, Edimax Technology Co., Ltd., declare under our sole responsibility, that the equipment described below complies with the requirements of the European R&TTE directives.

**Equipment: 54 Gigabit PoE ports Web-Smart Switch with 6 SFP+ 10 Gigabit
Model No.: GS-5654PLX V2**

The following European standards for essential requirements have been followed:

Directives 2014/30/EU

EMC : EN 55032:2015+A11:2020
EN IEC 61000-3-2:2019
EN 61000-3-3:2013+A1:2019
EN 55035:2017+A11:2020

Directives 2014/35/EU

Safety (LVD) : IEC 62368-1:2014 (2nd Edition) and/or EN 62368-1:2014+A11:2017

Edimax Technology Europe B.V.
Fijenhof 2,
5652 AE Eindhoven,
The Netherlands

Date & Place of Issue: 30/Nov./2022, Eindhoven

Signature: 

Printed Name: David Huang

Title: Director

a company of:

Edimax Technology Co., Ltd.
No. 278, Xinhua 1st Rd., Neihu Dist.,
Taipei City, Taiwan

Date & Place of Issue: 30/Nov./2022, Taipei

Signature: 

Printed Name: Hunter Chen

Title: Director



Declaration of Conformity

We, Edimax Technology Co., Ltd., declare under our sole responsibility, that the equipment described below complies with the requirements of the United Kingdom EMC and Safety directives.

**Equipment: 54 Gigabit ports Web-Smart Switch with 6 SFP+ 10 Gigabit
Model No.: GS-5654LX**

The following European standards for essential requirements have been followed:

Electromagnetic Compatibility Regulations 2016 (S.I. 2016/1091)

EMC : EN 55032:2015+AC:2016
EN 61000-3-2:2014
EN 61000-3-3:2013
EN 55035:2017

Electrical Equipment (Safety) Regulations 2016 (S.I. 2016/1101)

Safety (LVD) : IEC 62368-1:2014 (2nd Edition) and/or EN 62368-1:2014+A11:2017

Edimax Technology Europe B.V.
Fijenhof 2,
5652 AE Eindhoven,
The Netherlands

Date & Place of Issue: 30/Nov./2022, Eindhoven

Signature: 

Printed Name: David Huang

Title: Director

a company of:

Edimax Technology Co., Ltd.
No. 278, Xinhua 1st Rd., Neihu Dist.,
Taipei City, Taiwan

Date & Place of Issue: 30/Nov./2022, Taipei

Signature: 

Printed Name: Hunter Chen

Title: Director



Declaration of Conformity

We, Edimax Technology Co., Ltd., declare under our sole responsibility, that the equipment described below complies with the requirements of the United Kingdom EMC and Safety directives.

**Equipment: 54 Gigabit PoE ports Web-Smart Switch with 6 SFP+ 10 Gigabit
Model No.: GS-5654PLX V2**

The following European standards for essential requirements have been followed:

Electromagnetic Compatibility Regulations 2016 (S.I. 2016/1091)

EMC : EN 55032:2015+A11:2020
EN IEC 61000-3-2:2019
EN 61000-3-3:2013+A1:2019
EN 55035:2017+A11:2020

Electrical Equipment (Safety) Regulations 2016 (S.I. 2016/1101)

Safety (LVD) : IEC 62368-1:2014 (2nd Edition) and/or EN 62368-1:2014+A11:2017

Edimax Technology Europe B.V.
Fijenhof 2,
5652 AE Eindhoven,
The Netherlands

Date & Place of Issue: 30/Nov./2022, Eindhoven

Signature: 

Printed Name: David Huang

Title: Director

a company of:

Edimax Technology Co., Ltd.
No. 278, Xinhua 1st Rd., Neihu Dist.,
Taipei City, Taiwan

Date & Place of Issue: 30/Nov./2022, Taipei

Signature: 

Printed Name: Hunter Chen

Title: Director

