



HOZELOCK

Technical Hose - 2025 

DECLAIR AL Ø 13x20/Ø 12

SAINTS PHIBL

Technical Hose - for industrial use

Pond Hose

Spiral hose for use under water

- Suitable for use with ponds
- Not suitable for domestic waterworks and irrigation pumps
- Vacuum for 2m water column

*Our recycled PVC contains less than 0.1% of harmful phthalates (Reach regulation n°1907/2006)

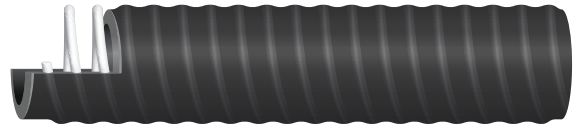

Spiral Dosto

For irrigation and drainage

- White impact-resistant spiral PVC
- Dimensionally stable wall made of soft PVC
- Vacuum for 6m water column

*Our recycled PVC contains less than 0.1% of harmful phthalates (Reach regulation n°1907/2006)

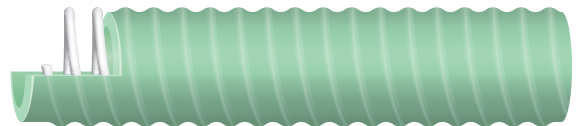

Aquarium

Water hose for use in aquariums, ponds or aqua-terrariums

- Single layer, flexible PVC construction
- Can be used with all the standard filter units
- Translucent green colour for discreet use

*Our recycled PVC contains less than 0.1% of harmful phthalates (Reach regulation n°1907/2006)



Cristal

Crystal clear PVC hose for pressure-less transport of liquids

- Single layer hose without reinforcement
- Food grade transparent PVC
- Suitable for carrying non fatty foodstuffs or light alcohols

*Our recycled PVC contains less than 0.1% of harmful phthalates (Reach regulation n°1907/2006)



Prisme

Compressed air suitable and food safe

- Clear multi-purpose hose
- With braided reinforcement
- Food grade transparent PVC

*Our recycled PVC contains less than 0.1% of harmful phthalates (Reach regulation n°1907/2006)

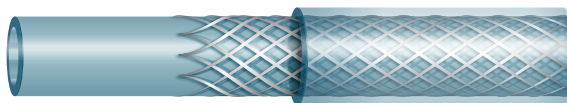

Sim. A, B, C, D1



(EU) - 10/2011



+60°C
-15°C



13 bar



40 bar

Drinking Water Hose

For the transfer of chemical and food liquids

- Compatible with a wide range of chemical products, plus drink water safe
- 5-layer hose with braided reinforcement
- Flexible and robust

*Our recycled PVC contains less than 0.1% of harmful phthalates (Reach regulation n°1907/2006)

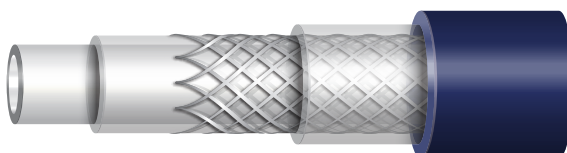

Sim. A, B, C, D1, D2
(EU) - 10/2011



+60°C
-15°C



16 bar



48 bar

Evergreen

Designed for garden watering

- Multi-purpose garden watering hose
- 3-layer hose with braided reinforcement
- Kink-resistant and flexible

*Our recycled PVC contains less than 0.1% of harmful phthalates (Reach regulation n°1907/2006)

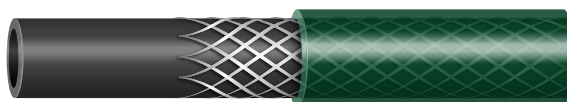

Anti-UV



+60°C
-15°C



ø12.5mm = 6 bar
ø25mm = 6 bar

ø19mm = 6 bar



ø12.5mm = 15 bar
ø25mm = 15 bar

ø19mm = 15 bar

Aquaease

A multi-purpose garden watering hose

- Flexible 5 layered hose for everyday use
- Re-enforced with TNT knitted anti-twist technology
- Soft and Flex layer providing a lightweight hose

*Our recycled PVC contains less than 0.1% of harmful phthalates (Reach regulation n°1907/2006)

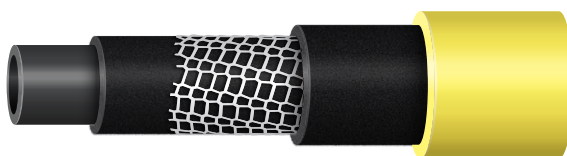

Anti-UV



+60°C
-15°C



ø12.5mm = 8 bar
ø19mm = 6 bar

ø15mm = 8 bar
ø25mm = 6 bar



ø12.5mm = 20 bar
ø19mm = 16 bar

ø15mm = 20 bar
ø25mm = 16 bar

Technical Hose - for industrial use

Aquamax

A flexible irrigation watering hose

- Flexible 5 layered hose for everyday use
- Re-enforced with TNT knitted anti-twist technology
- Soft and Flex layers with a smooth inner layer

*Our recycled PVC contains less than 0.1% of harmful phthalates (Reach regulation n°1907/2006)

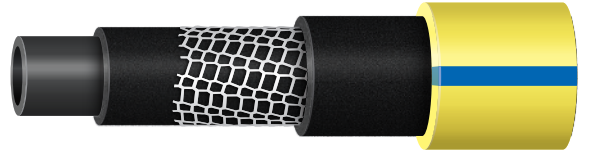

Anti-UV



+60°C
-15°C



ø12.5mm = 9 bar
ø19mm = 8 bar

ø15mm = 9 bar
ø25mm = 8 bar



ø12.5mm = 23 bar
ø19mm = 20 bar
ø15mm = 23 bar
ø25mm = 20 bar

Work Site Hose

For domestic and professional usage

- Highly UV Resistant
- PVC outer coating
- 3 layers with knitted re-enforcement

*Our recycled PVC contains less than 0.1% of harmful phthalates (Reach regulation n°1907/2006)

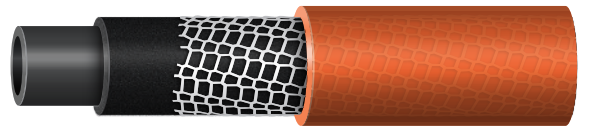

Anti-UV



+60°C
-15°C



ø13mm = 8 bar
ø19mm = 8 bar



ø13mm = 22 bar
ø19mm = 22 bar

Porous Soaker Hose

Targeted watering for young plants, hedges, and vegetable plots

- Reduces your water waste by watering the soil
- Increased plant health by keeping the soil moist
- Timmer compatible



+60°C
0°C



1-1.5 bar



>5 bar

Fuel Hose

Suitable for all fuel types

- Unique composition for hydrocarbon transfer
- Durable flexibility
- Allows visual control of fluids

*Our recycled PVC contains less than 0.1% of harmful phthalates (Reach regulation n°1907/2006)

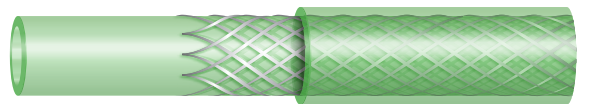

+60°C
-15°C





ø8mm = 13 bar
ø10mm = 10 bar





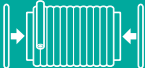



ø8mm = 40 bar
ø10mm = 30 bar



Technical Hose - for industrial use

Product	20cm Bobbin 	40cm Bobbin 	Coil 
---------	--	--	---

Pond Hose

100-101-094	 50m ø 12mm	-	-
100-101-096	 18m ø 20mm	-	-
100-101-100	-	 45m ø 20mm	-
100-101-098	 13m ø 25mm	-	-
100-101-102	-	 33m ø 25mm	-
100-101-104	-	 18m ø 32mm	-
100-101-106	-	 16m ø 40mm	-

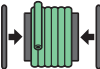
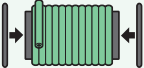
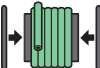
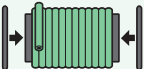
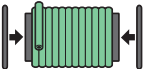









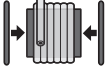

Spiral Hose

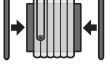
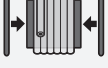
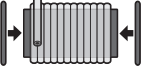
100-101-108	 20m ø 20mm	-	-
100-101-112	-	 50m ø 20mm	-
100-101-110	 12m ø 25mm	-	-
100-101-114	-	 27m ø 25mm	-
100-101-116	-	 18m ø 32mm	-
100-101-118	-	-	 25m ø 40mm

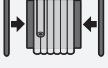
Aquarium Hose

100-101-121	 390m ø 4 x 6mm	-	-
-------------	---	---	---



Technical Hose - for industrial use

Product	20cm Bobbin 	40cm Bobbin 	Coil 
Cristal Hose			
100-101-133	 390m ø 4 x 6mm	-	-
100-101-135	 170m ø 6 x 9mm	-	-
100-101-137	 110m ø 8 x 11mm	-	-
100-101-139	 75m ø 10 x 13mm	-	-
100-101-147	-	 180m ø 10 x 13mm	-
100-101-141	 60m ø 12 x 15mm	-	-
100-101-149	-	 140m ø 12 x 15mm	-
100-101-143	 35m ø 15 x 19mm	-	-
100-101-151	-	 90m ø 15 x 19mm	-
100-101-145	 15m ø 20 x 26mm	-	-
100-101-153	-	 45m ø 20 x 26mm	-
100-101-155	-	 30m ø 25 x 31mm	-
100-101-157	-	-	 25m ø 40 x 49mm

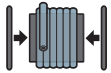
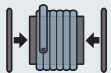
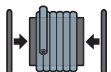
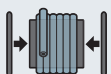
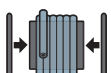
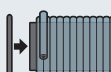
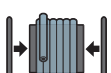

Technical Hose - for industrial use

Product	20cm Bobbin	40cm Bobbin	Coil
---------	-------------	-------------	------



Prisme Hose

100-101-159	 110m ø 6,3 x 11mm	-	-
100-101-161	 75m ø 8 x 13mm	-	-
100-101-163	 60m ø 10 x 15mm	-	-
100-101-165	 35m ø 12,5 x 18mm	-	-
100-101-167	 25m ø 16 x 22mm	-	-
100-101-171	-	 60m ø 16 x 22mm	-
100-101-169	 15m ø 19 x 26mm	-	-
100-101-173	-	 45m ø 19 x 26mm	-





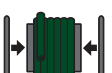

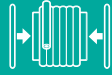
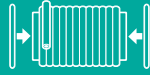

Drinking Hose

100-101-175	 35m ø 13 x 19mm	-	-
100-101-179	-	 90m ø 13 x 19mm	-
100-101-183	-	-	 25m ø 25 x 33,5mm

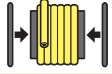
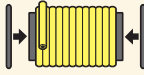
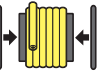
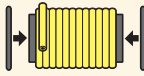
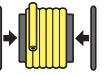
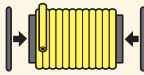
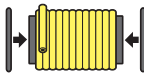
Evergreen Hose

100-101-185	 60m ø 12,1 x 14,9mm	-	-
100-101-189	-	 140m ø 12,1 x 14,9mm	-
100-101-194	-	 30m ø 24,5 x 29,6mm	-

Technical Hose - for industrial use

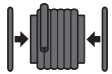
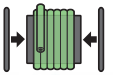
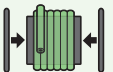
Product	20cm Bobbin 	40cm Bobbin 	Coil 
Aquaease Hose			
100-101-196	 45m ø 12,5 x 17mm	-	-
100-101-202	-	 110m ø 12,5 x 17mm	-
100-101-198	 35m ø 14,5 x 18,6mm	-	-
100-101-204	-	 90m ø 14,5 x 18,6mm	-
100-101-200	 25m ø 18,7 x 23,5mm	-	-
100-101-206	-	 60m ø 18,7 x 23,5mm	-
100-101-208	-	 30m ø 25 x 31mm	-
Aquamax Hose			
100-101-224	-	-	 50m ø 30 x 39mm
100-101-226	-	-	 50m ø 40 x 51mm
100-101-238	-	-	 50m ø 50 x 63mm
Work Site Hose			
100-101-236	-	-	 40m ø 13 x 18mm
100-101-238	-	-	 40m ø 19 x 25mm
Porous Hose			
100-101-242	 45m ø 12,5 x 16mm	-	-
Fueling Hose			
100-101-244	 70m ø 8 x 14mm	-	-
100-101-246	 55m ø 10 x 16mm	-	-

Pond Hose

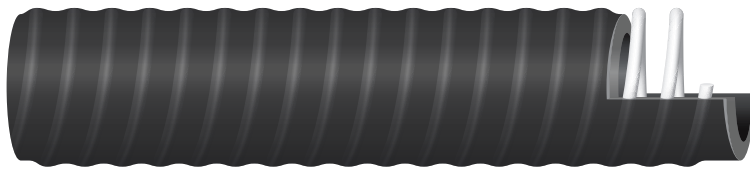

Spiral hose for use under water

- Suitable for use with ponds
- Not suitable for domestic waterworks and irrigation pumps
- Vacuum for 2m water column

Create your ideal pond system with the pond hose, designed for seamless connections between pumps, filters, UVCs, fountains, and waterfalls.

Engineered from high-quality plastics, ensuring durability and longevity. It offers a bend radius three times its diameter, minimising kinks and splits for uninterrupted water flow

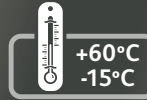

	ø 12 mm	ø 20 mm	
SAP Code	100-101-094	100-101-096	100-101-100
Product	Pond Hose	Pond Hose	Pond Hose
Bobbin/Coil	20cm	20cm	40cm
Length	50m	18m	45m
Coils on Euro Pallet	42	42	18
PC Barcode			
CAR Barcode			

	ø 25 mm	ø 32 mm	ø 40 mm	
SAP Code	100-101-098	100-101-102	100-101-104	100-101-106
Product	Pond Hose	Pond Hose	Pond Hose	Pond Hose
Bobbin/Coil	20cm	40cm	40cm	40cm
Length	13m	33m	18m	16m
Coils on Euro Pallet	42	18	18	18
PC Barcode				
CAR Barcode				

mm	mm	mm	mm	g/m	mbar	mm
12	+/- 1,0	1	2,5	105	350	30
20	+/- 1,0	1	2,5	160	350	35
25	+/- 1,0	1	2,7	217	350	40
32	+/- 1,0	1	3,1	260	350	45
40	+/- 1,0	1	3,2	337	300	50

Key:

Only available as a Bobbin

Only available as a Coil

Spiral Hose

For irrigation and drainage

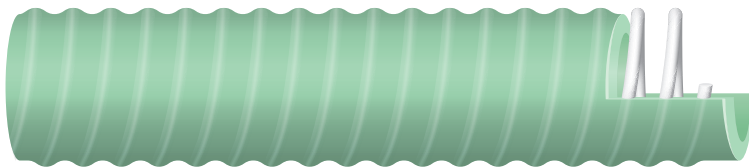

- White impact-resistant spiral PVC
- Dimensionally stable wall made of soft PVC
- Vacuum for 6m water column

Spiral hose is a lightweight and flexible hose. The inner wall is smooth to reduce flow losses while the transparent flexible pvc allows visual checks of the transferred material. Shock proof PVC is used in the spiral ridge to ensure durability and performance.



	ø 20 mm		ø 25 mm	
SAP Code	100-101-108	100-101-112	100-101-110	100-101-114
Product	Spiral Hose		Spiral Hose	
Bobbin/Coil	20cm	40cm	20cm	40cm
Length	20m	50m	12m	27m
Coils on Euro Pallet	42	42	42	42
PC Barcode				
CAR Barcode				

	ø 32 mm	ø 40 mm
SAP Code	100-101-116	100-101-118
Product	Spiral Hose	
Bobbin/Coil	40cm	
Length	18m	25m
Coils on Euro Pallet	42	42
PC Barcode		
CAR Barcode		

mm	mm	mm	mm	bar	bar	mm	mm
20	+/- 1,0	2,4	220	6	18	600	80
25	+/- 1,0	2,4	270	5	15	600	105
32	+/- 1,0	2,5	350	5	15	600	135
40	+/- 0,6	2,9	500	5	15	600	180

Key:

Only available as a Bobbin

Only available as a Coil

Aquarium Hose

Water hose for use in aquariums, ponds or aqua-terrariums









- Single layer, flexible PVC construction
- Can be used with all the standard filter units
- Translucent green colour for discreet use

Aquarium hose is versatile and flexible single layer hose, compatible with all standard filtration units. The translucent PVC allows for visual checks on the water flow while being discreet in all ponds, aqua terrariums and Aquariums.



ø 4 x 6 mm

SAP Code	100-101-121
Product	Aquarium Hose
Bobbin/Coil	20cm 
Length	390m 
Coils on Euro Pallet	42
PC Barcode	 5 010646 065726 >
CAR Barcode	 5 010646 995658 >

								
mm	mm	mm	mm	mm	g/m	bar	bar	mm
4	+/- 0,20	6	+/- 0,20	1	34	13	40	72

Key:



Only available as a Bobbin



Only available as a Coil

Cristal Hose

Crystal clear PVC hose for pressure-less transport of liquids



- Single layer hose without reinforcement
- Food grade transparent PVC
- Suitable for carrying non fatty foodstuffs or light alcohols

Cristal hose with its food grade transparent PVC (EU 10/2011) (SIM A,B,C) is flexible and designed for the transfer of non fatty food substances such as sugars, honey, vegetable juices and light alcohol. The clear PVC allows for visual checks of the transferred substances.



Sim. A, B, C
(EU) - 10/2011

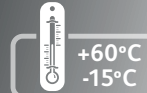

	ø 4 x 6 mm	ø 6 x 9 mm	ø 8 x 11 mm	ø 10 x 13 mm	
SAP Code	100-101-133	100-101-135	100-101-137	100-101-139	100-101-147
Product	Cristal Hose				
Bobbin/Coil	20cm	20cm	20cm	20cm	40cm
Length	390m	170m	110m	75m	180m
Coils on Euro Pallet	42	42	42	42	18
PC Barcode					
CAR Barcode					

	ø 12 x 15 mm		ø 15 x 19 mm	
SAP Code	100-101-141	100-101-149	100-101-143	100-101-151
Product	Cristalr Hose			
Bobbin/Coil	20cm	40cm	20cm	40cm
Length	60m	140m	35m	90m
Coils on Euro Pallet	42	18	42	18
PC Barcode				
CAR Barcode				

mm	+/-	mm	mm	+/-	g/m
4	+/- 0,2	6	1,0	+/- 0,2	19
6	+/- 0,3	9	1,5	+/- 0,2	43
8	+/- 0,4	11	1,5	+/- 0,2	54
10	+/- 0,5	13	1,5	+/- 0,2	66
12	+/- 0,5	15	1,5	+/- 0,3	77
15	+/- 0,8	19	2,0	+/- 0,3	130

Key:



Only available as a Bobbin



Only available as a Coil

Crystal clear PVC hose for pressure-less transport of liquids



- Single layer hose without reinforcement
- Food grade transparent PVC
- Suitable for carrying non fatty foodstuffs or light alcohols

Cristal hose with its food grade transparent PVC (EU 10/2011) (SIM A,B,C) is flexible and designed for the transfer of non fatty food substances such as sugars, honey, vegetable juices and light alcohol. The clear PVC allows for visual checks of the transferred substances.



Sim. A, B, C
(EU) - 10/2011



+60°C
-15°C

	ø 20 x 26 mm		ø 25 x 31 mm	ø 40 x 49 mm
SAP Code	100-101-145	100-101-153	100-101-155	100-101-157
Product	Cristal Hose		Cristal Hose	Cristal Hose
Bobbin/Coil	20cm	40cm	40cm	
Length	15m	45m	30m	25m
Coils on Euro Pallet	42	18	18	-
PC Barcode				
CAR Barcode				

mm	+/-	mm	mm	mm	g/m
20	+/- 0,5	26	3,0	+/- 0,3	260
25	+/- 1,0	31	3,0	+/- 0,3	317
40	+/- 1,0	49	4,5	+/- 0,5	764

Key:

Only available as a Bobbin

Only available as a Coil

Prisme Hose

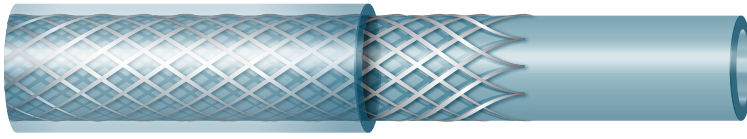

Compressed air suitable and food safe

- Clear multi-purpose hose
- With braided reinforcement
- Food grade transparent PVC

A multipurpose hose suitable for various applications such as the supply of compressed air to pneumatic tools. The flexible PVC and polyester reinforcement provide resistance to pressure deformation even at low pressures. Prisme hose is also suitable for food and liquid transfer (SIM A,B,C,D1) examples being fruit juice, milk, wines and some alcohols <50% volume.

Sim. A, B, C, D1 (EU) 10/2011
 +60°C -15°C
 13 bar
 40 bar

	ø 6,3 x 11 mm	ø 8 x 13 mm	ø 10 x 15mm	ø 12,5 x 18 mm
SAP Code	100-101-159	100-101-161	100-101-163	100-101-165
Product	Prisme Hose	Prisme Hose	Prisme Hose	Prisme Hose
Bobbin/Coil	20cm	20cm	20cm	20cm
Length	110m	75m	60m	35m
Coils on Euro Pallet	42	42	42	42
PC Barcode				
CAR Barcode				

	ø 16 x 22 mm		ø 19 x 26 mm	
SAP Code	100-101-167	100-101-171	100-101-169	100-101-173
Product	Prisme Hose	Prisme Hose	Prisme Hose	Prisme Hose
Bobbin/Coil	20cm	40cm	20cm	40cm
Length	25m	60m	15m	45m
Coils on Euro Pallet	42	42	42	42
PC Barcode				
CAR Barcode				

mm	mm	mm	mm	mm	g/m	bar	bar	mm
6,3	+/- 0,5	11	+/- 0,5	2,35	77	13	40	50
8	+/- 0,5	13	+/- 0,6	2,50	100	13	40	65
10	+/- 0,5	15	+/- 0,6	2,50	120	13	40	80
12,5	+/- 0,5	18	+/- 0,7	2,75	160	13	40	110
16	+/- 0,5	22	+/- 0,8	3,00	217	13	40	145
19	+/- 0,5	26	+/- 0,8	3,50	300	13	40	174

Key:

Only available as a Bobbin
 Only available as a Coil

Drinking Hose

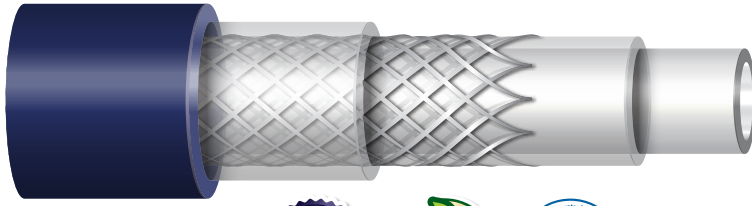

For the transfer of chemical and food liquids

- Compatible with a wide range of chemical products, plus drink water safe
- 5-layer hose with braided reinforcement
- Flexible and robust

A 5 layered hose for the transfer of food liquids and drinking water (SIM A,B,C,D1, D2). Certified in 2021 by IWA-21-DW-10090 meaning it is drinking water safe as well as passing a microbacteriological test on the end product. The structure provides flexibility, durability and performance within its inner layers and also soft comfort on the external blue layer.



Sim. A, B, C, D1,D2
(EU) - 10/2011



+60°C
-15°C



16
bar



48
bar

	ø 13 x 19 mm		ø 25 x 33,5 mm
SAP Code	100-101-175	100-101-179	100-101-183
Product	Drinking Hose		Drinking Hose
Bobbin/Coil	20cm	40cm	
Length	35m	90m	25m
Coils on Euro Pallet	42	18	-
PC Barcode			
CAR Barcode			

mm	mm	mm	mm	mm	g/m	bar	bar	mm
13	+/- 0,6	19	+/- 0,6	3	134	16	48	125
25	+/- 0,8	33,5	+/- 0,8	4,25	348	16	48	230

Key:

Only available as a Bobbin

Only available as a Coil

Evergreen Hose

Designed for garden watering

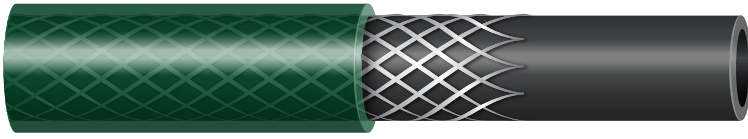









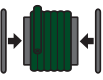
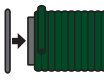
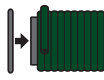









- Multi-purpose garden watering hose
- 3-layer hose with braided reinforcement
- Kink-resistant and flexible

Evergreen hose is the introduction to your garden watering. With anti-uv coating and a smooth inner layer for even water flow so your garden can flourish. The braided reinforcement ensures kink resistance whilst remaining flexible.

*Our recycled PVC contains less than 0.1% of harmful phthalates (Reach regulation n°1907/2006)



	ø 12,1 x 14,9 mm		ø 24,5 x 29,6 mm
SAP Code	100-101-185	100-101-189	100-101-194
Product	Evergreen Hose		Evergreen Hose
Bobbin/Coil	20cm 	40cm 	40cm 
Length	60m 	140m 	30m 
Coils on Euro Pallet	42	18	18
PC Barcode	 5 010646 066044 >	 5 010646 066068 >	 5 010646 066082 >
CAR Barcode	 5 010646 995979 >	 5 010646 995993 >	 5 010646 996013 >

								
mm	mm	mm	mm	g/m	bar	bar	bar	mm
12,1	+/- 0,5	14,9	+/- 0,5	1,4	77	6	15	160
24,5	+/- 0,9	29,6	+/- 0,9	2,55	282	6	15	300

Key:



Only available as a Bobbin



Only available as a Coil



Aquaease Hose



A multi-purpose garden watering hose

- Flexible 5 layered hose for everyday use
- Re-enforced with TNT knitted anti-twist technology
- Soft and Flex layer providing a lightweight hose

A 5 layer hose with enhanced technical performance. Soft and flex layers of PVC inside the hose add crush protection while TNT knitting provides anti kink and twist prevention. Flexible with UV protection make the hose a multipurpose gardening hose for all needs.

*Our recycled PVC contains less than 0.1% of harmful phthalates (Reach regulation n°1907/2006)



	ø 12,5 x 17 mm		ø 14,5 x 18,6 mm	
SAP Code	100-101-196	100-101-202	100-101-198	100-101-204
Product	Aquaease Hose	Aquaease Hose	Aquaease Hose	Aquaease Hose
Bobbin/Coil	20cm	40cm	20cm	40cm
Length	45m	110m	35m	90m
Coils on Euro Pallet	42	18	42	18
PC Barcode				
CAR Barcode				

	ø 18,7 x 23,5 mm		ø 25 x 31 mm
SAP Code	100-101-200	100-101-206	100-101-208
Product	Aquaease Hose	Aquaease Hose	Aquaease Hose
Bobbin/Coil	20cm	40cm	40cm
Length	25m	60m	30m
Coils on Euro Pallet	42	18	-
PC Barcode			
CAR Barcode			

mm	mm	mm	mm	mm	g/m	bar	bar	mm
12,5	+/- 0,7	17	+/- 0,7	2,25	116	8	20	140
14,5	+/- 0,8	18,6	+/- 0,8	2,05	127	8	20	160
18,7	+/- 0,9	23,5	+/- 0,9	2,40	194	6	16	200
25		31		3,00	306	6	16	255

Key:

Only available as a Bobbin

Only available as a Coil

Aquamax Hose

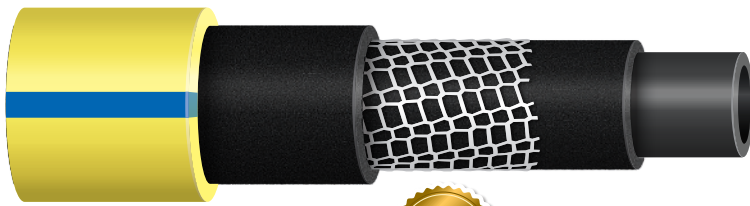

A flexible irrigation watering hose

- Flexible 5 layered hose for everyday use
- Re-enforced with TNT knitted anti-twist technology
- Soft and Flex layers with a smooth inner layer

A 5 layer hose with enhanced technical performance. Soft and flex layers of PVC inside the hose add crush protection while TNT knitting provides anti kink and twist prevention. Flexible and soft inner layers make the hose durable while remaining lightweight, and with UV protection creates an all year round robust hose for all garden and watering.

*Our recycled PVC contains less than 0.1% of harmful phthalates (Reach regulation n°1907/2006)



	ø 30 x 39mm	ø 40 x 51mm	ø 50 x 63mm
SAP Code	100-101-224	100-101-226	100-101-228
Product	Aquamax Hose	Aquamax Hose	Aquamax Hose
Bobbin/Coil			
Length	50m	50m	50m
Coils on Euro Pallet	-	-	-
PC Barcode			
CAR Barcode			

mm	mm	mm	mm	mm	g/m	bar	bar	mm
30	+/- 1,1	39	+/- 1,1	4,5	571	8	20	300
40	+/- 1,2	51	+/- 1,5	5,5	1009	8	20	350
50	+/- 1,2	63	+/- 1,5	6,5	1486	8	20	400

Key:

Only available as a Bobbin

Only available as a Coil



Work Site Hose



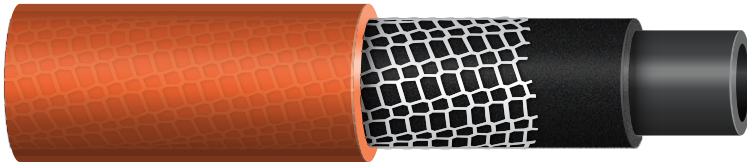





For domestic and professional usage











- Highly UV Resistant
- PVC outer coating
- 3 layers with knitted re-inforcement

A highly resistant hose to UV due to the nature of this hose being exposed to weather elements or long periods of time. A thick inner and outer PVC wall add to the robust nature of the hose with the 3 layers including a knitted re-inforcement to reduce kinks and twists.



	ø 13 x 18 mm	ø 19 x 25 mm
SAP Code	100-101-236	100-101-238
Product	Work Site Hose	Work Site Hose
Bobbin/Coil		
Length	40m 	40m 
Coils on Euro Pallet	42	42
PC Barcode	 5 010646 066297 >	 5 010646 066303 >
CAR Barcode	 5 010646 996228 >	 5 010646 996235 >

								
mm	mm	mm	mm	mm	g/m	bar	bar	mm
13	+/- 0,7	18	+/- 0,7	2,5	152	8	22	140
19	+/- 0,9	25	+/- 0,9	3,0	255	8	22	185

Key:



Only available as a Bobbin



Only available as a Coil

Porous Hose





Targeted watering for young plants, hedges, and vegetable plots





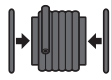

- Reduces your water waste by watering the soil
- Increased plant health by keeping the soil moist
- Timmer compatible

Made with upto 40% recycled rubber the structure of the hose is ideally designed for specific nderground irrigation. Preventing evaporation and delivering the water directly ito the soil there is reduced water waste.



ø 12,5 x 16 mm	
SAP Code	100-101-242
Product	Porous Hose
Bobbin/Coil	20cm 
Length	45m 
Coils on Euro Pallet	42
PC Barcode	 5 010646 066327 >
CAR Barcode	 5 010646 996259 >

				
mm	mm	mm	bar	bar
12,5	+/- 0,5	16	1-1,5	>5

Key:



Only available as a Bobbin



Only available as a Coil



Fueling Hose

Suitable for all fuel types

- Unique composition for hydrocarbon transfer
- Durable flexibility
- Allows visual control of fluids

The unique composition of PVC material in this hose is designed specifically for hydrocarbon transfer. It remains flexible and bending even after repeated use. This clear core and braided reinforcement make it ideal for visual checking of transfer material.

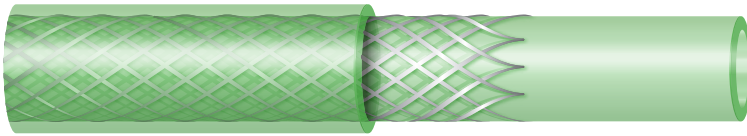

	ø 8 x 14 mm	ø 10 x 16 mm
SAP Code	100-101-244	100-101-246
Product	Fueling Hose	Fueling Hose
Bobbin/Coil	20cm	20cm
Length	70m	55m
Coils on Euro Pallet	42	42
PC Barcode	5 010646 066334 >	5 010646 066341 >
CAR Barcode	5 010646 996266 >	5 010646 996273 >

mm	mm	mm	mm	mm	g/m	bar	bar	mm
8	+/- 0,5	14	+/- 0,5	3	129	13	40	56
10	+/- 0,5	16	+/- 0,5	3	152	10	30	70

Key:



Only available as a Bobbin

Only available as a Coil





POS Solutions



Code	900-100-556
Product	Technical Hose Stand
	
Description	<ul style="list-style-type: none"> • The large unit allows for the an organised, strong and stand out structure for your Technical Hose Display. • The stand design is adaptable to each customer requirements of Technical Hose ranges. • Included within are 3 bars to hold the garages in place as well as the 1m cutter guide with increments of 10cm.
Display Dimensions	Height: 2225 mm Width: 1245 mm Depth: 610 mm
Packaging Dimensions	Height: 280 mm Width: 1250 mm Depth: 590 mm
Quantity	x1
Outer EAN	

Code	900-100-558
Product	Technical Hose Mobile Stand 1m
	
Description	<ul style="list-style-type: none"> • The smaller mobile unit allows for the same organised structure to your Technical Hose Display. • The included wheels provide manouverability throughout the store while maintaining product information support for informed purchasing. • Included within are 3 bars to hold the garages in place as well as the 1m cutter guide with increments of 10cm.
Display Dimensions	Height: 2350 mm Width: 1040 mm Depth: 565 mm
Packaging Dimensions	Height: 170 mm Width: 1200 mm Depth: 650 mm
Quantity	x1
Outer EAN	

Code	900-100-548
Product	Adjustable Bars and 1m Measure Guide Pack
	
Description	<ul style="list-style-type: none"> • Additional 1m measuring bar with incremental 10cm guide. Also 3 x Bars with adjustable brackets (1m – 1.33m).
Display Dimensions	Height: 100 mm Width: 1020 mm Depth: 570 mm
Packaging Dimensions	Height: 120 mm Width: 1050 mm Depth: 590 mm
Quantity	x1
Outer EAN	

Code	900-100-550
Product	Bobbin Side Discs
	
Description	<ul style="list-style-type: none"> • Side disks allow the Technical Hose bobbin to rotate within the garage and avoid the hose coming into contact with the display ensuring easy and effortless unwind.
Display Dimensions	Height: 400 mm Width: 400 mm Depth: 100 mm
Packaging Dimensions	Height: 410 mm Width: 410 mm Depth: 200 mm
Quantity	x2
Outer EAN	

Code	900-100-540	900-100-543
Product	20cm Garage	40cm Garage
		
Description	<ul style="list-style-type: none"> • The 20cm garage will enable a quick and effortless unwind of your 20cm technical hose bobbins while keeping the display tidy. • The included extrusion allows for labels to be added to share product information. • An added Thumb Screw allows for the tear off barcode strip to be attached. 	<ul style="list-style-type: none"> • The 40cm garage will enable a quick and effortless unwind of your larger technical hose bobbins while keeping the display tidy. • The included extrusion allows for labels to be added to share product information. • An added Thumb Screw allows for the tear off barcode strip to be attached.
Display Dimensions	Height: 217 mm Width: 178 mm Depth: 479 mm	Height: 217 mm Width: 372 mm Depth: 479 mm
Packaging Dimensions	Height: 330 mm Width: 520 mm Depth: 210 mm	Height: 330 mm Width: 520 mm Depth: 390 mm
Quantity	x2	x2
Outer EAN	 5 010646 996365 >	 5 010646 996372 >

Code	900-100-552	900-100-???
Product	Label Set	Tear off Checkout Set
		
Description	<ul style="list-style-type: none"> • Labels for each variant of Technical Hose detailing the features, benefits and applications for each hose. 	<ul style="list-style-type: none"> • Each tear off strip is printed with the product description, diameters (inner and outer where applicable) and space to detail the length purchased by the customer. This can be torn at the fixture for convenience and taken to the checkout
Display Dimensions	Height: 100 mm Width: 1020 mm Depth: 570 mm	Height: 400 mm Width: 400 mm Depth: 100 mm
Packaging Dimensions	Height: 120 mm Width: 1050 mm Depth: 590 mm	Height: 410 mm Width: 410 mm Depth: 200 mm
Quantity	x1	x2
Outer EAN	 5 010646 996419 >	

1

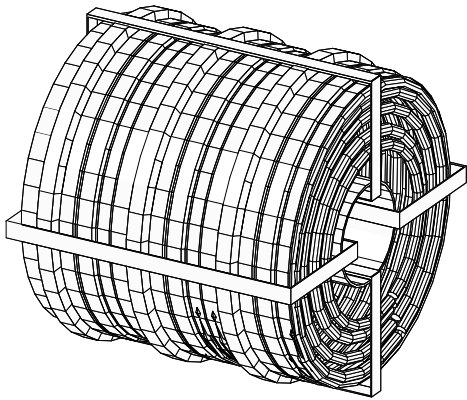

2

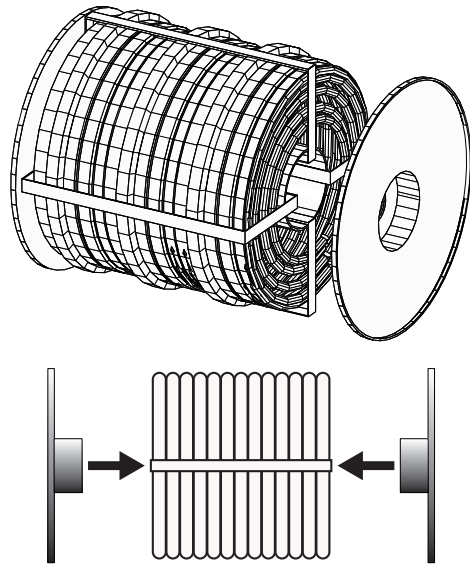

3

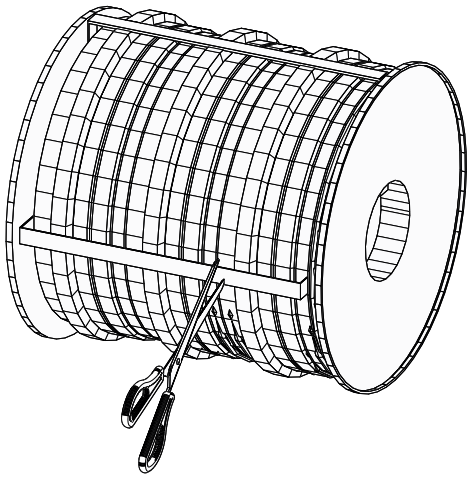

4

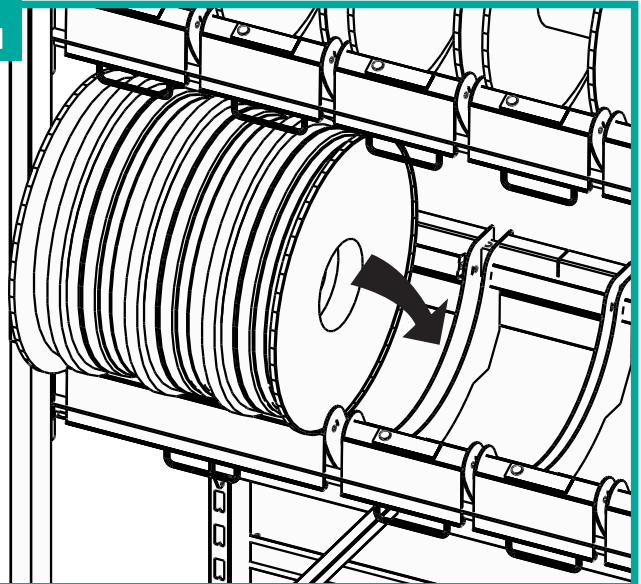

5

