

---

EC685 EC695 EC785

COFFEE MAKER



---

**DeLonghi**



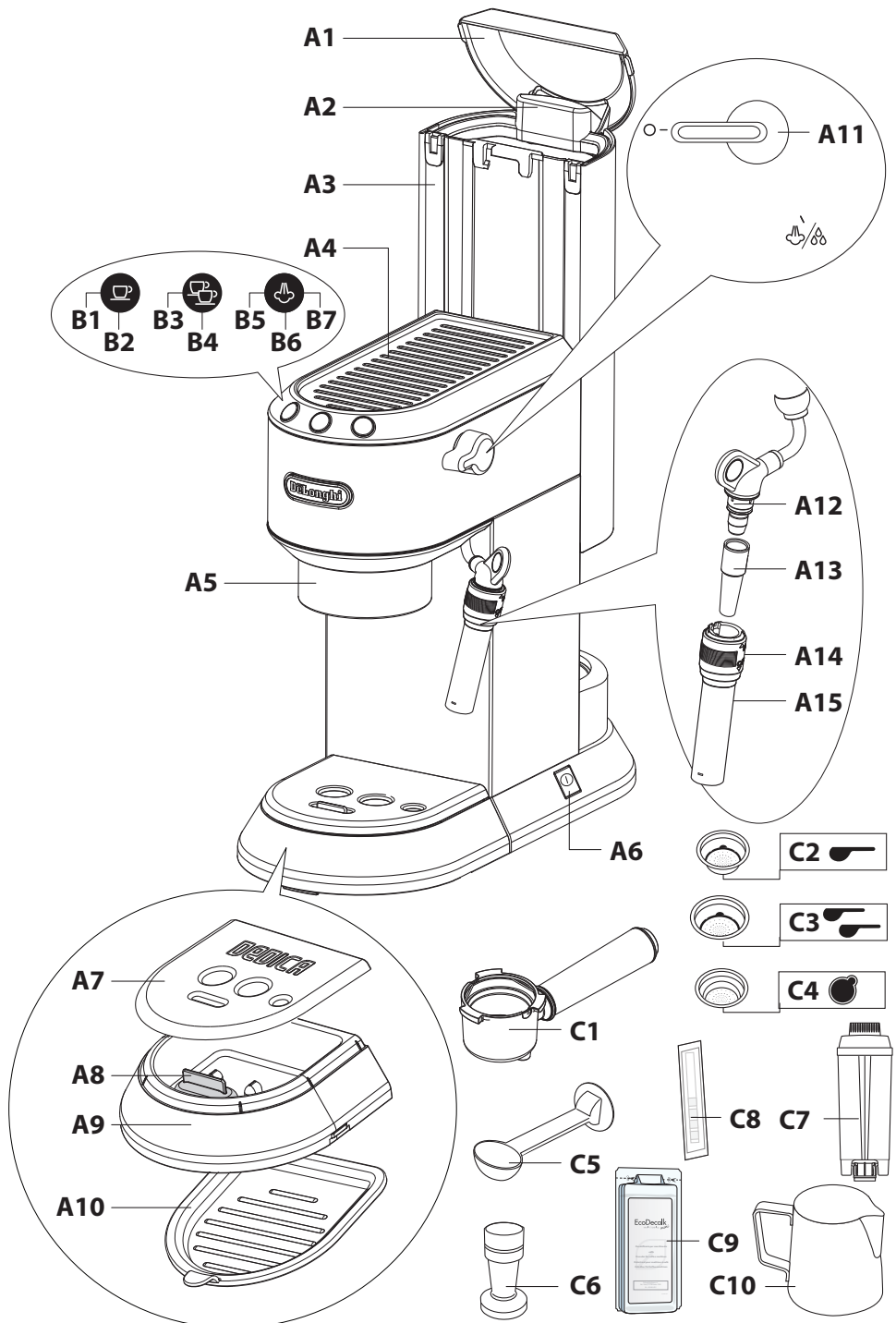

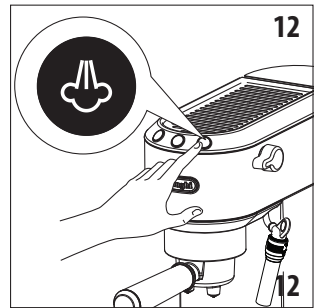
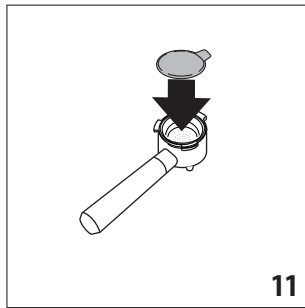
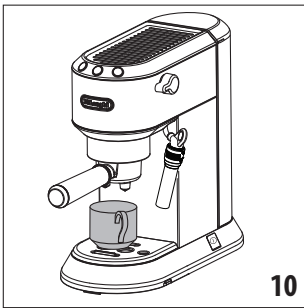
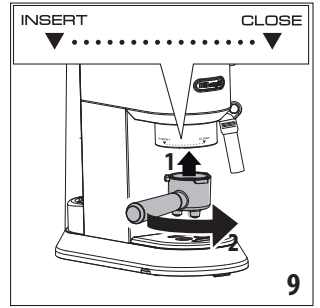
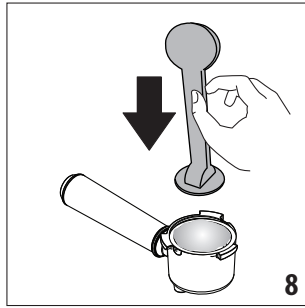
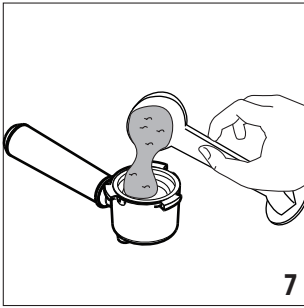
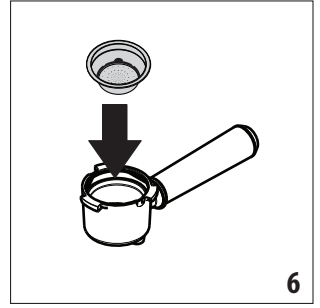
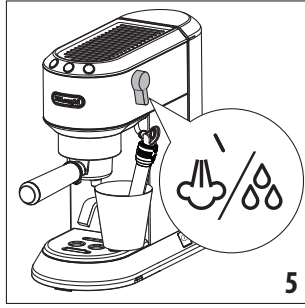
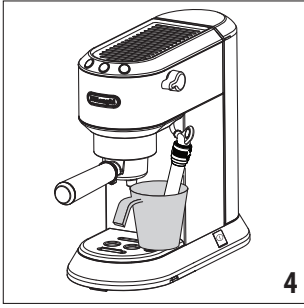
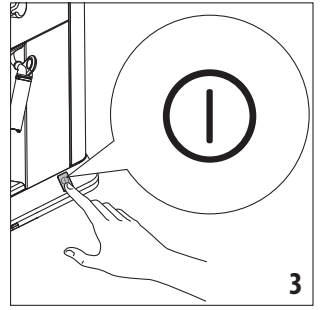
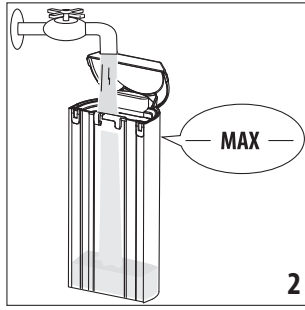
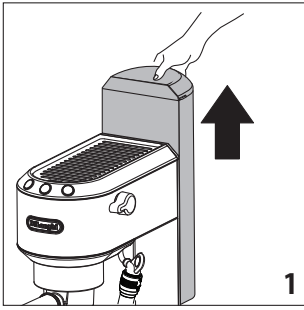

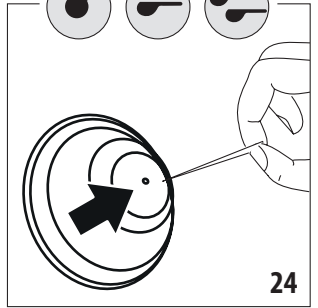
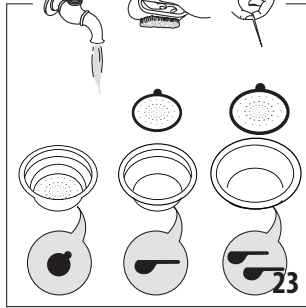
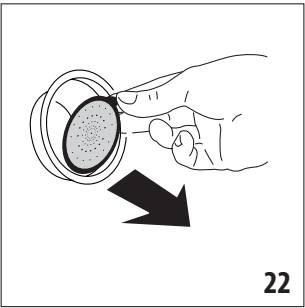
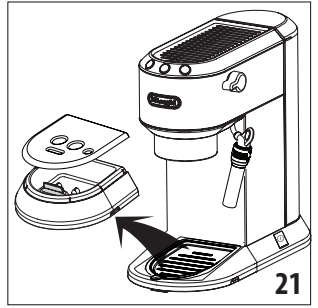
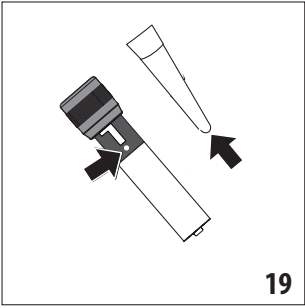
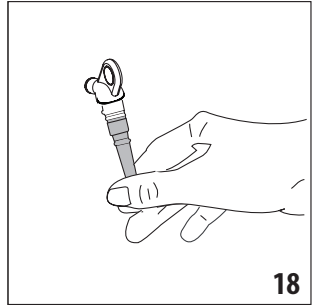
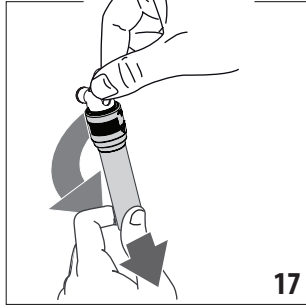
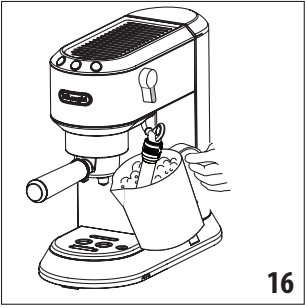
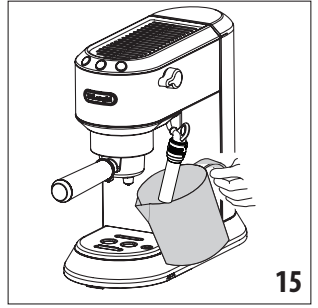
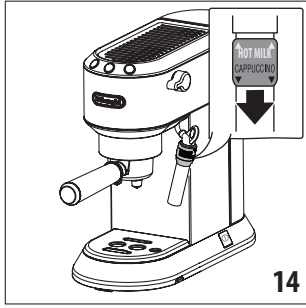
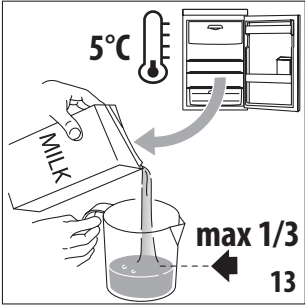

Before using the appliance, always read the safety warnings.

## 1. DESCRIPTION



### 1.1 Description of appliance - A

- A1. Water tank lid
- A2. Water tank extraction handle
- A3. Water tank
- A4. Cup warmer
- A5. Coffee spouts
- A6. Main switch (ON/OFF)
- A7. Cup grille
- A8. Water level indicator in drip tray
- A9. Drip tray
- A10. Mug or glass tray (Only in certain models)
- A11. Steam dial
- A12. Hot water/steam dispenser
- A13. Hot water/steam nozzle
- A14. Frother dial
- A15. Hot water/steam wand

### 1.2 Description of control panel - B

- B1. 1 cup button
- B2. "ON" light (white) in the button
- B3. 2 cup button
- B4. "ON" light (white) in the button
- B5. Steam button
- B6. "ON" light (white) in the button
- B7. "Descal light" (orange)

### 1.3 Description of accessories - C

- C1. Filter holder
- C2. 1-cup filter ( symbol under filter)
- C3. 2-cup filter ( symbol under filter)
- C4. Pod filter ( symbol under filter) (Only in certain models)
- C5. Scoop/Tamper (Only in certain models)
- C6. Tamper (Only in certain models)
- C7. Water softener filter (not included, available for purchase at authorised service centres)
- C8. Water hardness test
- C9. Descaler (Only in certain models)
- C10. Milk jug (Only in certain models)

**Please note:** to identify your model, see the nameplate located on the bottom of the appliance.

### 1.4 Optional cleaning accessories recommended by the manufacturer

For more information, visit [www.delonghi.com](http://www.delonghi.com).

 **WaterFilter** **Water softener filter**  
EAN: 8004399327252

## 2. PREPARING THE APPLIANCE

Wash all accessories with warm water and washing-up liquid, then proceed as follows:











1. Extract the water tank (A3) (fig. 1) and fill it with fresh clean water, taking care not to exceed the MAX level (fig. 2).
2. Reinsert the tank, pressing lightly to open the valves located on the bottom of the tank itself.

**Important:** *Never operate the appliance without water in the tank or without the tank.*

**Please note:** *You should customise water hardness as soon as possible following the instructions in section "9. Settings menu".*

## 3. SETTING UP THE APPLIANCE

When used for the first time, the internal circuits of the appliance must be rinsed as follows:



1. Plug into the mains socket. Press the main switch (A6) (fig. 3).
2. The appliance runs a self-diagnosis cycle, indicated by the sequential flashing of the three keys   
3. The lights  and  flash, indicating that the appliance is heating up: when the lights are steadily lit, the appliance is ready to perform a rinse cycle.
4. Attach the filter holder to the appliance; align the filter holder handle with "INSERT", then rotate to the right until the handle is aligned with "CLOSE" (fig. 9).
5. Place a container with a capacity of at least 0.5 litres under the coffee spout (A5) and the hot water/steam dispenser (fig. 4).
6. Press the button . Repeat this procedure 5 times.
7. Turn the steam dial (A11) to position  (fig. 5) and dispense hot water: the appliance automatically stops dispensing and the lights  and  flash. Turn the knob back to position . The purpose of this procedure is to purge any water from the circuit before using steam to prepare a beverage.

The appliance is ready for use.

**Please note:** *It is normal for there to be water in the space under the tank. This should therefore be dried regularly with a clean sponge.*

## 4. MAKING COFFEE

1. Place the ground coffee filter (C2) or (C3) in the filter holder (C1) (fig. 6).
2. Fill the filter with ground coffee (fig. 7). Make sure to use finely ground coffee specifically for espresso.
3. Distribute the ground coffee evenly and press down gently with the tamper (C5) or (C6) (fig. 8). Make sure the coffee is at the right level after tamping. You may need to add more coffee.

4. Remove any excess coffee from the rim of the filter holder and attach it to the appliance (fig. 9).
5. Place the cup or cups under the filter holder spouts
6. Make sure the lights corresponding to the coffee buttons are on, then press the coffee button  (B1) or  (B3).
7. The appliance proceeds to make the coffee and delivery stops automatically.
8. To remove the filter holder, turn the handle from right to left.

**Please note:**

- For correct operation, before filling with ground coffee, check that the filter has no coffee powder residue from the previous brew.
- While the appliance is making coffee, delivery can be interrupted at any moment by pressing the coffee button pressed previously.
- At the end of delivery (within 3 seconds), to increase the amount of coffee in the cup, press and hold the coffee button pressed previously. Delivery stops automatically after a few seconds.
- To avoid splashes, never remove the filter holder while the appliance is delivering coffee. Always wait for a few seconds after delivery.

#### 4.1 Pressing the coffee:

Correct pressing of the ground coffee is essential to obtain a good espresso.

- If you press too firmly, the coffee will be delivered slowly and will be strong.
- If you press too lightly, the coffee will be delivered quickly and will be weak.

#### 4.2 Tips for a hotter coffee

- Before making the coffee, warm the cups by rinsing them with a little hot water.
- Attach the filter holder (C1) with the filter (C2) or (C3) to the appliance, **but without adding coffee**. Using the same cup as will later be used to make the coffee, press the 1 cup button and deliver hot water into the cup to heat it.
- Increase the coffee temperature in the settings menu (see "9. Settings menu").
- Stand the cups you will be using on the cup warmer (A4) which becomes hot during operation.

### 5. HOW TO MAKE ESPRESSO COFFEE USING PODS

1. Insert the coffee pod filter (C4) in the filter holder (C1).
2. Insert the pod, centring it as much as possible on the filter (fig. 11). Always follow the instructions on the pod pack to position the pod on the filter correctly.
3. Attach the filter holder to the appliance (fig. 9).

4. Place the cup under the filter holder spouts.
5. Make sure the lights corresponding to the coffee buttons are on, then press the coffee button  (B1).
6. The appliance proceeds to make the coffee and delivery stops automatically.
7. To remove the filter holder, turn the handle from right to left.

#### 5.1 Choosing the pod

use pods conforming to the ESE standard, indicated on the pack by the symbol.



The ESE standard is a system accepted by leading pod producers and enables espresso coffee to be prepared simply and cleanly.



**Please note:**

- **When using pods, you can only make one coffee at a time.**
- While the appliance is making coffee, delivery can be interrupted at any moment by pressing the coffee button pressed previously.
- At the end of delivery (within 3 seconds), to increase the amount of coffee in the cup, press and hold the coffee button pressed previously. Delivery stops automatically after a few seconds.
- To avoid splashes, never remove the filter holder while the appliance is delivering coffee. Always wait for a few seconds after delivery.
- See section "4.2 Tips for a hotter coffee".





### 6. PROGRAMMING THE QUANTITIES OF COFFEE IN THE CUP

The appliance is set by default to automatically deliver standard quantities. To change these quantities, proceed as follows:





1. Place one or two cups under the filter holder spouts (C1).
2. Press and hold the button you want to programme ( or ).
3. The coffee maker starts delivering coffee and the other coffee button flashes to indicate that the appliance is in programming mode.
4. Once the required quantity of coffee has been delivered into the cup, release the button. Delivery stops and the light flashes to indicate that the quantity has been saved correctly.

	Default quantity	Programmable quantity
	35 ml	from $\approx 15$ to $\approx 90$ ml
	70 ml	from $\approx 30$ to $\approx 180$ ml

## 7. HOW TO MAKE CAPPUCCINO COFFEE

1. Prepare the espresso coffee as described above, using sufficiently large cups. To use tall glasses, remove the drip tray and stand the glasses on the mug and glass tray (A10);
2. Press  (fig. 12): the light flashes;
3. In the meantime, fill a container with about 100 grams of milk for each cappuccino that will be prepared. For dense and consistent froth, skim or semi-skimmed refrigerated milk (about 5°C) should be used. When choosing the size of the container, consider that the milk will increase in volume two- or three-fold (fig. 13).
4. Check that the frother dial (A14) is set to "CAPPUCCINO" (fig. 14);
5. Wait for the  key to light up steadily, indicating that the boiler has reached the ideal temperature to produce steam.
6. Place an empty container under the frother and open the dial for a few seconds to purge any water in the circuit. Close the dial again.
7. Place the container with the milk under the frother.
8. Immerse the frother in the milk container, taking care never to immerse the black-coloured ring (fig. 15). Turn the dial to position . The frother dispenses steam that gives the milk a creamy appearance and increases its volume (fig. 16). For creamier steam, immerse the frother into the milk and move the container slowly in circular motions, from the bottom up.
9. When the temperature (ideally 60°C) and desired cream density have been reached, stop the steam supply by turning the steam dial to position .
10. Pour the frothed milk into the cups containing the espresso coffee prepared previously. The cappuccino is ready: add sugar to taste and, if desired, sprinkle some cocoa powder over the froth.

### Please note:

- to prepare more than one cappuccino, make all the coffees first, then prepare the frothed milk for all the cappuccinos at the end;
- To exit the steam function, press any of the keys. The  and  lights flash to indicate that the steam dial must be closed again ( symbol). If the  and  lights flash simultaneously to indicate that the temperature is too high to dispense coffee, see section '7.3 Cooling cycle'.

You should not deliver steam for more than 60 seconds.

## 7.1 Preparing hot milk

To prepare hot, unfrothed milk, follow the instructions above, making sure the frother dial (A14) is positioned upwards, set to "HOT MILK".

## 7.2 Cleaning the frother after each use



### Important:



For hygiene reasons, the frother should be cleaned after each use.

Proceed as follows:





1. Release any trapped steam for a few seconds (points 2, 5 and 6 above), rotating the steam dial. This procedure will drain any milk trapped inside the frother. Turn off the appliance from the ON/OFF button.
2. Wait a few minutes for the frother to cool: with one hand, hold the frother wand still and with the other, release the frother itself by twisting it counter-clockwise, then pull it downwards (fig. 17).
3. Remove the rubber steam nozzle from the wand, pulling it downwards (fig. 18).
4. Push the ring upwards and check that the holes indicated by the arrow in fig. 19 are not blocked. If necessary, clean with the help of a pin;
5. Re-fit the nozzle, moving the ring downwards, then reinsert the frother on the nozzle, turning and pushing it upwards until it clicks in.

## 7.3 Cooling cycle

If after using the steam function, the two  and  lights flash simultaneously, indicating that the boiler needs to cool down to reach the correct espresso temperature, proceed as follows:









- place a container under the cappuccino maker;
- open the steam dial to dispense steam and hot water: the light  flashes;
- when the lights ( and ) flash, the boiler has cooled: close the steam dial (when the boiler has cooled, dispensing stops). The appliance is now ready for use.

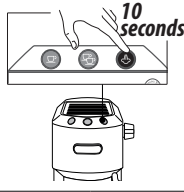
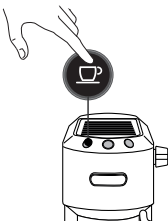

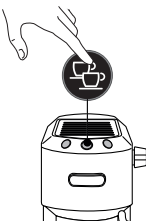

## 8. HEATING WATER

1. Place a container under the hot water/steam dispenser.
2. Wait for the coffee dispensing lights  and  to turn on.
3. Turn the steam (A11) dial to . Hot water will come out of the hot water/steam dispenser.
4. To stop the flow of hot water, turn the dial to .

You should not deliver hot water for more than 60 seconds.

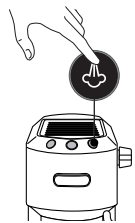
## 9. SETTINGS MENU

1. Access the menu:		
Press and hold the  button for 10 seconds until the three buttons flash in sequence:		
2. Select the setting to be adjusted		
Corresponding setting	Press to select the setting	Press to change the setting
<b>Brewing temperature</b>	 <i>This is the temperature of the water in the thermoblock. It is therefore not the temperature of the beverage in the cup or the temperature of the beverage at the moment of release from the outlets of the filter holder.</i>	Press  to select <b>Low</b> temperature
		Press  to select <b>Medium</b> temperature
		Press  to select <b>High</b> temperature
<b>Water hardness</b>		Press  to select <b>Low</b> hardness
		Press  to select <b>Medium</b> hardness
		Press  to select <b>High</b> hardness
→		

<b>Auto-off</b>		Press  to select <b>9 minutes</b> (* 5 min)
		Press  to select <b>30 minutes</b> (* 90 min)
		Press  to select <b>3 hours</b>
3. Exit the menu		
After 15 seconds of inactivity, the machine automatically exits the settings menu.		

(\* ) Only for models EC685 EX4, EC685 EX4, EC785 EX4





### Please note:

- The light corresponding to the changed setting flashes quickly to confirm the change.
- After 15 seconds of inactivity, the machine automatically exits the settings menu and is ready for use.

## 10. DEFAULT VALUES (RESET)

This resets the machine to the default values.

Proceed as follows:

1. Position the hot water/steam dispenser on the drip tray (A9);
2. Access the settings menu.
3. Turn the steam dial (A11) to ;
4. Press the button . The three lights flash simultaneously to confirm that the original settings have been restored.
5. The  and  lights flash to indicate that the steam dial must be closed again (○ symbol).

When the steam dial has been closed, the appliance is ready for use.

## 11. CLEANING THE MACHINE

The following parts of the machine must be cleaned regularly:

- drip tray (A9)
- coffee filters (C2), (C3) and (C4);
- coffee spout (A5);
- water tank (A3);
- the hot water/steam dispenser as indicated in chapter "7.2 Cleaning the frother after each use";

### **Important!**

- None of the components or accessories is dishwasher safe.
- Do not use solvents, abrasive detergents or alcohol to clean the coffee machine.
- Do not use metal objects to remove encrustations or coffee deposits as they could scratch metal or plastic surfaces.
- If the appliance is not used for more than a week, before using it again, we recommend performing a rinse cycle as described in chapter "3. Setting up the appliance".

### **Danger!**

- Never immerse the coffee maker in water when cleaning: it is an electrical appliance.
- Before commencing any cleaning operation on the outside of the machine, turn it off, unplug it from the mains socket and wait for it to cool down.

## **11.1 Cleaning the drip tray**

### **Important!**

The drip tray is fitted with a level indicator (red) showing the level of water it contains. Before the indicator starts to protrude from the cup tray (fig. 20), the tray must be emptied and cleaned, otherwise the water may spill over the edge and damage the appliance, the support surface or the surrounding area.

1. Remove the tray (A9) (fig. 21).
2. Remove the cup grille (A7), eliminate the water and clean the tray with a cloth, then reassemble the drip tray. Extract the mug or glass tray (A10), clean with water, dry and put back in the machine;
3. Put the drip tray back in place.

## **11.2 Cleaning the coffee filters**

The coffee filters are designed to achieve the best possible coffee froth. To keep them efficient, they must always be kept clean and free of any coffee residue.

- After each use, rinse the filter under plenty of running water (fig. 23), then press on the perforated filter to check that it is properly seated.
- Check that the hole on the back of the filter (see fig. 24) is free of any residue.

If the filter is still dirty, or in any case at least once a month, clean the coffee filters as follows:

1. Extract the perforated filter by pulling the tab (fig. 22).
2. Rinse the filters under running water (fig. 23).
3. Make sure the holes are not blocked. If necessary, clean with a pin (fig. 24).
4. Wipe dry with a cloth.
5. Reinsert the perforated filter in its seat and press it down all the way.

## **Pod filter**

Rinse with running water. Make sure the holes are not blocked. If necessary, clean with a pin (fig. 23-24).

## **11.3 Cleaning the coffee spouts**

After every 200 coffees, rinse by delivering about 0.5 litres of water from the spouts (press the coffee button without using ground coffee).

## **11.4 Other cleaning operations**

1. Do not use solvents or abrasive detergents to clean the coffee maker. Use a soft damp cloth only.
2. Clean the filter holder cup.

## **11.5 Cleaning the water tank**

1. Clean the water tank regularly (about once a month) and whenever you replace the water softener filter (if present) with a damp cloth and a little mild washing up liquid;
2. Remove the filter (if present) and rinse with running water;
3. Put the filter (if present) back in the appliance, fill the tank with fresh water and put back in the machine;
4. Deliver 100ml of water (models with water softener filter only).

## **12. DESCALING**

When the orange  key light flashes, run a descaling cycle.

### **Important!**

- Before using the descaler (C9), read the instructions and the labelling on the pack.
- Use De'Longhi descaler only. Using unsuitable descaler and/or performing descaling incorrectly may result in faults not covered by the manufacturer's guarantee.
- Descaler can cause damage to delicate surfaces. If the product is accidentally spilt, dry immediately.

<b>To descale</b>	
Descaler	De'Longhi descaler
Container	Capacity 1 L
Time	~25min

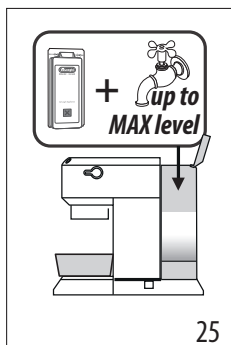

1. Check that the filter holder is not attached and place a container under the hot water dispenser and under the boiler outlet.
2. Pour the descaler solution into the tank, diluting the supplied descaler with water (fill the tank up to the MAX level) (fig. 25)

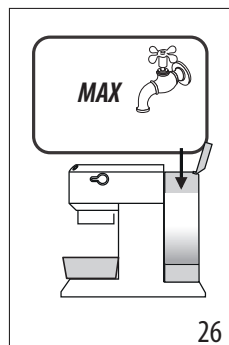

25



26

3. Press and hold the  button for 10 seconds until the three buttons flash in sequence.
4. Turn the steam dial to .
5. Press the  button to start descaling.
6. The descaling programme starts and the descaler solution comes out from the hot water/steam dispenser. The descaling programme automatically runs a series of rinse cycles at set intervals, removing any limescale deposits from inside the coffee machine until the tank is emptied.





**Please note:**

During descaling, **close the steam dial** from time to time to deliver small quantities of descaler to clean the coffee circuit.

Delivery stops and the orange  light continues to flash to indicate the descaling cycle is still underway.

You now need to rinse the appliance.

7. Empty the container used to collect the descaler solution and reposition it under the spouts.

8. The machine is ready for rinsing with fresh, clean water. Extract the water tank, empty and rinse it under running water, fill it with fresh water (fig. 26) and put it back in the appliance.
9. Make sure the steam dial is in position , then press the  button to start rinsing. During descaling, **close the steam dial from time to time** to deliver small quantities of water from the coffee spouts to clean the coffee circuit.
10. Perform a second rinse cycle from points 7 to 9 with the filter inserted (if present previously).
11. When the water tank is empty, the orange light goes off and descaling is complete. The  and  lights flash.
12. Close the steam dial, setting it to .
13. Fill the tank with fresh water.

The machine is now ready for use.

**Please note:**







- If the descaling cycle is not correctly completed (e.g. electrical power failure), it is recommended to repeat the cycle.

**Only for models EC685 EX4, EC685 EX4, EC785 EX4:**

If the descaling function is accidentally activated, it can be stopped by pressing the  button for at least 10 seconds.

If the descaling cycle is not completed due to a power failure, when the power is restored, the appliance will still be in descaling mode; therefore, wait for the descaling cycle to end and then the machine will be "ready for use".

### 13. EXPLANATION OF INDICATOR LIGHTS

Lights	Operation	Meaning
	The ON/OFF button is turned on	The appliance performs a self-diagnosis cycle, indicated by sequential flashing of the lights
	When the appliance is turned on	Flashing lights: the appliance is heating up to make coffee Lights on steadily: the appliance is ready to make coffee
	Steam dial open	Lights flashing: close the steam dial
	Cooling cycle required	Proceed as described in sect. "7.3 Cooling cycle".
	The water tank is empty or the machine does not make coffee	The lights flash rapidly. See section "3. Setting up the appliance"
	The steam function is required	Flashing light: the appliance is heating up to deliver steam Light on steadily: the appliance is ready to deliver steam
 <p><i>orange flashing</i></p>	The appliance needs descaling	Descal the appliance, the operation is complete when the  light goes off.

## 14. TROUBLESHOOTING

<b>Problem</b>	<b>Cause</b>	<b>Solution</b>
Espresso coffee is not delivered any more	No water in the tank	Fill the tank
	The holes in the filter holder are blocked	Clean the filter holder spout holes
	The filter is blocked, or the perforated filter is missing	Clean as described in section "11.2 Cleaning the coffee filters"
	The tank has been inserted incorrectly and the valves on the bottom are not open	Press the tank down lightly to open the valves on the bottom
	Limescale in the water circuit	Descale as described in section "12. Descaling"
The espresso coffee drips from the edges of the filter holder rather than the holes	The filter holder has been inserted incorrectly or is dirty	Attach the filter holder correctly and rotate firmly as far as it will go
	The espresso boiler gasket has lost elasticity or is dirty	Have the espresso boiler gasket replaced by Customer Services
	The holes in the filter holder spouts are blocked	Clean the filter holder spout holes
	The filter is blocked, or the perforated filter is missing	Clean as described in section "11.2 Cleaning the coffee filters"
The filter holder cannot be attached to the appliance	Too much coffee has been placed in the filter	Use the measure supplied and make sure you are using the correct filter for the type of preparation
The espresso froth is too light (delivered from the spout too fast)	The pre-ground coffee is not pressed down firmly enough	Press the pre-ground coffee more firmly
	There is not enough pre-ground coffee	Increase the quantity of pre-ground coffee
	The pre-ground coffee is too coarse	Use only pre-ground coffee for espresso coffee makers
	The wrong type of pre-ground coffee is being used	Change the type of pre-ground coffee
The espresso froth is too dark (delivered from the spout too slowly)	The pre-ground coffee is pressed down too firmly	Press the coffee down less firmly
	The quantity of ground coffee is too high	Reduce the quantity of ground coffee
	The espresso boiler outlet is blocked	Clean as described in section "11.3 Cleaning the coffee spouts"
	The filter is blocked	Clean as described in section "11.2 Cleaning the coffee filters"
	The pre-ground coffee is too fine	Use only pre-ground coffee for espresso coffee makers
	The ground coffee is too fine or damp	Use pre-ground coffee for espresso coffee makers only and make sure it is not too damp
	Limescale in the water circuit	Descale as described in section "12. Descaling"
→		

<b>Problem</b>	<b>Cause</b>	<b>Solution</b>
After delivering coffee, the filter remains attached to the boiler outlet		Insert the filter holder again, deliver coffee, then remove the filter holder
The appliance does not make any beverage and the lights flash for a few seconds	No water in the tank	Fill the tank with water
	The tank has been inserted incorrectly and the valves on the bottom are not open	Press the tank down lightly to open the valves on the bottom
	The espresso boiler outlet is blocked	Clean as described in section "11.3 Cleaning the coffee spouts"
	The filter is blocked	Clean as described in section "11.2 Cleaning the coffee filters"
	Limescale in the water circuit	Descale as described in section "12. Descaling"
The appliance does not function and all the lights flash		Disconnect the appliance immediately and contact authorised Customer Services.
No milk froth is formed when making cappuccino	The dial is set to "HOT MILK"	Move the dial to "CAPPUCCINO"
	Milk not cold enough	Always use milk at refrigerator temperature
	Cappuccino maker dirty	Clean the cappuccino maker as described in section "7.2 Cleaning the frother after each use"
	Limescale in the water circuit	Descale as described in section "12. Descaling"



**Register Now**   
[www.delonghi.com/register](http://www.delonghi.com/register)