

Fiche technique | Numéro d'article: 750-468
Entrée analogique à 4 canaux; DC 0 ... 10 V; Single-Ended

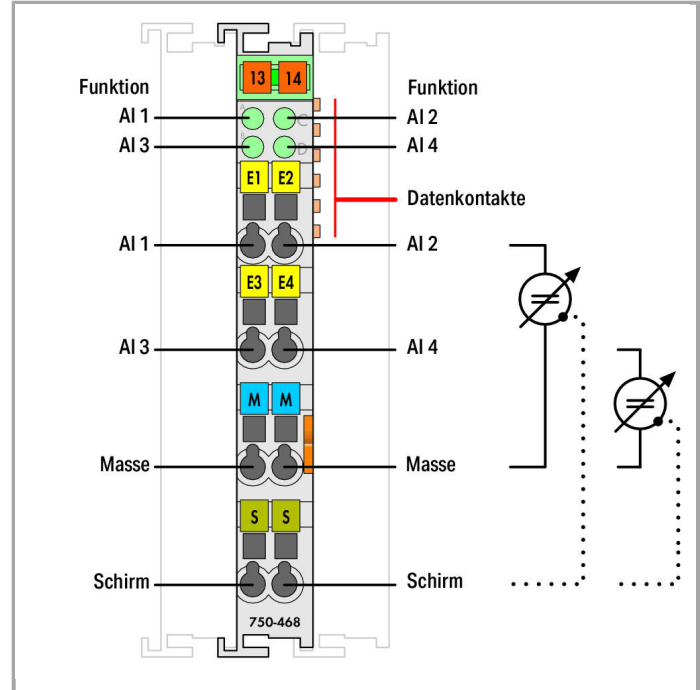

www.wago.com/750-468



RoHS Compliant

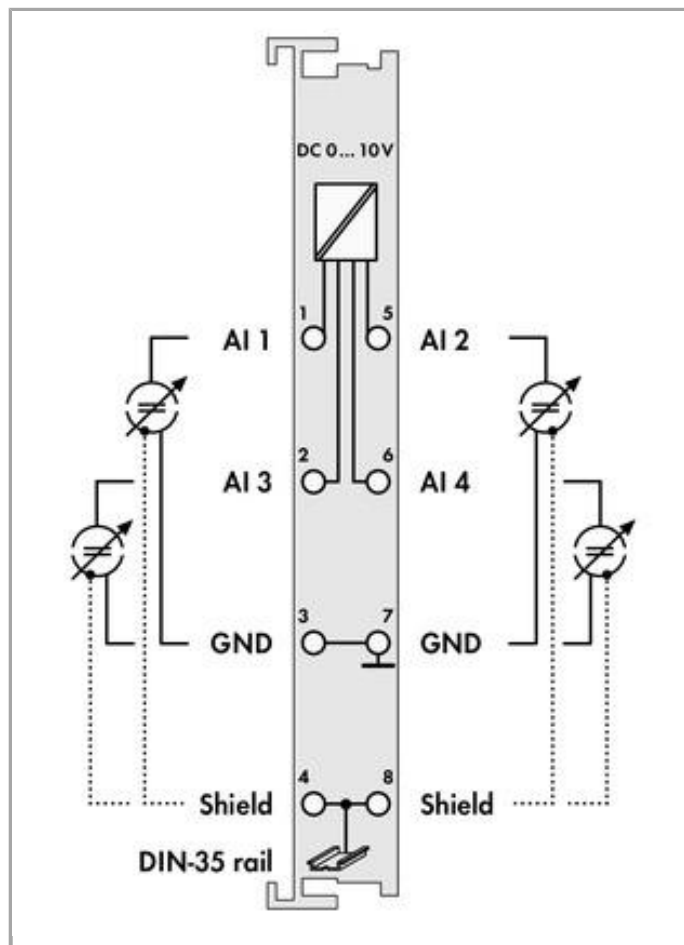
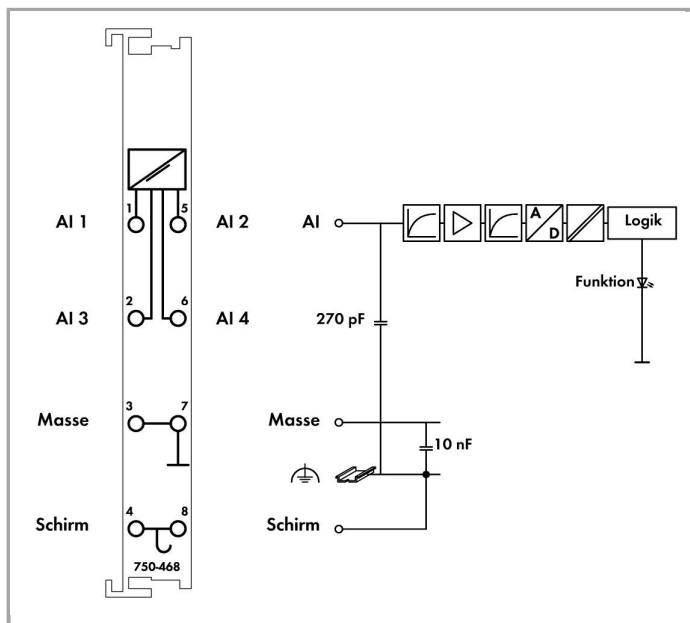

Description du produit :

Cette borne d'entrées analogiques traite des signaux sur une plage standardisée de 0-10 V.

Le signal d'entrée est séparé galvaniquement et le transfert à l'unité centrale se fait avec une résolution de 12 bits.

La borne est alimentée par la tension interne du coupleur du bus de terrain au moyen d'un convertisseur DC/DC.

Les canaux d'entrées du module possèdent un potentiel de masse commun.

Le blindage est directement connecté au rail.

Données

Données techniques

Nombre d'entrées analogiques	4
Nombre de canaux au total (module)	4
Type de signal	Voltage
Type of signal voltage	DC 0 ... 10 V
Raccordement capteur	4 x (2 conducteurs)
Tension d'entrée max.	35 V
Caractéristique du signal	Single-Ended

Résolution [Bit]	12 Bit
Unité d'adressage	4 x 16 bits données ; 4 x 8 bits contrôle/état (optionnel)
Résistance interne Mesure de tension	133 k Ω
Temps de conversion typ.	4 ms
Erreur de mesure/sortie, température de référence	25 °C
Erreur de mesure/sortie, écart de la pleine échelle	0.2 %
Coefficient de température	0.01 %/K
Tension d'alimentation système	DC 5 V; via data contacts
Consommation de courant alimentation système (5 V)	60 mA
Séparation galvanique	500 V (système/alimentation)

Données de raccordement

Anschlussstechnik: Ein-/Ausgänge	8 x CAGE CLAMP®
Type de connexion 1	Inputs/Outputs
Conducteur rigide	0,08 ... 2,5 mm ² / 28 ... 14 AWG
Conducteur souple	0,08 ... 2,5 mm ² / 28 ... 14 AWG
Longueur de dénudage	8 ... 9 mm / 0.31 ... 0.35 inch

Données géométriques

Largeur	12 mm / 0.472 inch
Hauteur	69,8 mm / 2.748 inch
Profondeur à partir du niveau supérieur du rail	62,6 mm / 2.465 inch
Profondeur	100 mm / 3.937 inch

Données mécaniques

Type de montage	Rail 35
-----------------	---------

Données du matériau

Couleur	gris clair
Matériel de l'enveloppe	Polycarbonate, polyamide 6.6
Charge calorifique	0.943 MJ
Poids	50 g
Marquage de conformité	CE

Conditions d'environnement

Température ambiante (fonctionnement)	0 ... 55 °C
Température ambiante (stockage)	-40 ... 85 °C
Indice de protection	IP20
Degré de pollution 5	2 selon CEI 61131-2



Altitude de fonctionnement	0 ... 2000 m
Position de montage	horizontal, vertical
Humidité relative (sans condensation)	95 %
Résistance aux vibrations	4g per IEC 60068-2-6
Résistance aux chocs	15g per IEC 60068-2-27
CEM - Susceptibilité en réception	selon EN 61000-6-2, construction navale
CEM : en émission	selon EN 61000-6-4, construction navale
Contrainte par matières polluantes	Per IEC 60068-2-42 and IEC 60068-2-43
Concentration maximale en matière polluante H2S admise à une humidité relative < 75 %	10 ppm
Concentration maximale en matière polluante SO2 admise à une humidité relative < 75 %	25 ppm

Dates commerciales

Country of origin	DE
GTIN	4045454393045
Customs Tariff No.	85389099990
Product Group	15 (Remote I/O)

Autorisations / certificats

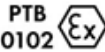
Ex-approbations



Logo	Approbation	Nom du certificat
	ATEX TUEV Nord Cert GmbH	TÜV 07 ATEX 554086 X en.
	TUEV Nord TUEV Nord Cert GmbH	IECEX TUN 09.0001 X
	UL Underwriters Laboratories Inc. (HAZARDOUS LOCATIONS)	E198726 Sec.1 (HAZARDOUS LOCATIONS)

Approbations spécifiques au pays

Logo	Approbation	Nom du certificat
	KC National Radio Research Agency	MSIP-REM-W43-AIM750
	KC National Radio Research Agency	MSIP-REM-W43-AIM750



Approbations de navire

Logo	Approbation	Nom du certificat
	ABS American Bureau of Shipping	16-HG1554285-PDA
	BV Bureau Veritas S.A.	13453/DO BV
	DNV GL Det Norske Veritas, Germanischer Lloyd	TAA0000194
	DNV GL Det Norske Veritas, Germanischer Lloyd	TAA0000194
	DNV DNV Germany GmbH	A-14093
	LR Lloyds Register	02/20026 (E5)
	PRS Polski Rejestr Statkow	TE/1989/880590/13
	RINA RINA Germany GmbH	ELE134212XG

Approbations UL









Logo	Approbation	Nom du certificat
	UL UL International Netherlands B.V. (ORDINARY LOCATIONS)	E175199 Sec.1 (ORDINARY LOCATIONS)

















Produits correspondants





shield connection

	N° art.: 790-108 Etrier de serrage de blindage; Largeur 11 mm; Diamètre de blindage; jusqu'à 8 mm	www.wago.com/790-108
	N° art.: 790-116 Etrier de serrage de blindage; Largeur 19 mm; Diamètre de blindage; 7 mm à 16 mm	www.wago.com/790-116
	N° art.: 790-124 Etrier de serrage de blindage; Largeur 27 mm; Diamètre de blindage; 6 mm à 24 mm	www.wago.com/790-124
	N° art.: 790-140 Etrier de serrage de blindage; Largeur 43 mm; Diamètre de blindage; 22 mm à 40 mm	www.wago.com/790-140
	N° art.: 790-208 Etrier de serrage de blindage; Diamètre 3 - 8 mm; Largeur 12,4 mm	www.wago.com/790-208
	N° art.: 790-216 Etrier de serrage de blindage; Diamètre 6 - 16 mm; Largeur 21,8 mm	www.wago.com/790-216
	N° art.: 790-220 Etrier de serrage de blindage; Diamètre 6 - 20 mm; Largeur de 30 mm	www.wago.com/790-220











system box

	N° art.: 850-804 Boîtier avec indice de protection IP65; Acier inoxydable; LxHxProf.(400x123x200 mm); Presse-étoupes 4 x M20, 6 x M16, 10 x M12	www.wago.com/850-804
	N° art.: 850-804/000-001 Boîtier avec indice de protection IP65; Acier inoxydable; LxHxProf.(400x123x200 mm); Presse-étoupes 2 x M20, 13 x M16, 32 x M12	www.wago.com/850-804/000-001
	N° art.: 850-805 Boîtier avec indice de protection IP65; Acier inoxydable; LxHxProf.(600x123x200 mm); Presse-étoupes 4 x M20, 19 x M16, 67 x M12	www.wago.com/850-805
	N° art.: 850-814/002-000 Boîtier avec indice de protection IP65; tôle d'acier (RAL 7035); LxHxProf.(200x120x200 mm); sans plaque pour presse-étoupes	www.wago.com/850-814/002-000
	N° art.: 850-815/002-000 Boîtier avec indice de protection IP65; tôle d'acier (RAL 7035); LxHxProf.(300x120x200 mm); sans plaque pour presse-étoupes	www.wago.com/850-815/002-000
	N° art.: 850-816/002-000 Boîtier avec indice de protection IP65; tôle d'acier (RAL 7035); LxHxProf.(400x120x200 mm); sans plaque pour presse-étoupes	www.wago.com/850-816/002-000
	N° art.: 850-817/002-000 Boîtier avec indice de protection IP65; tôle d'acier (RAL 7035); LxHxProf.(600x120x200 mm); sans plaque pour presse-étoupes	www.wago.com/850-817/002-000
	N° art.: 850-825 Boîtier avec indice de protection IP65; Aluminium (RAL 7032); LxHxProf.(160x100x160 mm); 9 x M12, 4 x M20	www.wago.com/850-825
	N° art.: 850-826	

	Boîtier avec indice de protection IP65; Aluminium (RAL 7032); LxHxProf.(240x100x160 mm); Presse-étoupes 4 x M20, 4 x M16, 14 x M12	www.wago.com/850-826
	N° art.: 850-826/002-000 Boîtier avec indice de protection IP65; Aluminium (RAL 7035); LxHxProf.(240x100x160 mm); Presse-étoupes 4 x M20, 4 x M16, 14 x M12	www.wago.com/850-826/002-000
	N° art.: 850-827 Boîtier avec indice de protection IP65; Aluminium (RAL 7032); LxHxProf.(320x100x160 mm); Presse-étoupes 4 x M20, 8 x M16, 17 x M12	www.wago.com/850-827
	N° art.: 850-827/002-000 Boîtier avec indice de protection IP65; Aluminium (RAL 7035); LxHxProf.(320x100x160 mm); Presse-étoupes 4 x M20, 8 x M16, 17 x M12	www.wago.com/850-827/002-000
	N° art.: 850-828 Boîtier avec indice de protection IP65; Aluminium (RAL 7032); LxHxProf.(480x100x160 mm); Presse-étoupes 4 x M20, 10 x M16, 35 x M12	www.wago.com/850-828
	N° art.: 850-828/002-000 Boîtier avec indice de protection IP65; Aluminium (RAL 7035); LxHxProf.(480x100x160 mm); Presse-étoupes 4 x M20, 10 x M16, 35 x M12	www.wago.com/850-828/002-000
	N° art.: 850-834 Boîtier avec indice de protection IP65; Polyester (RAL 7032); LxHxProf.(164x100x164 mm); 9 x M12, 4 x M20	www.wago.com/850-834
	N° art.: 850-835 Boîtier avec indice de protection IP65; Polyester (RAL 7032); LxHxProf.(244x100x164 mm); Presse-étoupes 4 x M20, 4 x M16, 14 x M12	www.wago.com/850-835
	N° art.: 850-836 Boîtier avec indice de protection IP65; Polyester (RAL 7032); LxHxProf.(324x100x164 mm); Presse-étoupes 4 x M20, 8 x M16, 17 x M12	www.wago.com/850-836
Carrier rail		
	N° art.: 210-112 Rail acier; 35 x 7,5; épaisseur 1 mm; longueur 2 m; perforé; d'après EN 60715; Largeur de trou 25 mm; pas des trous 36 mm	www.wago.com/210-112
	N° art.: 210-113 Rail acier; 35 x 7,5; épaisseur 1 mm; longueur 2 m; non perforé; d'après EN 60715	www.wago.com/210-113
	N° art.: 210-114 Rail acier; 35 x 15; épaisseur 1,5 mm; longueur 2 m; non perforé; d'après EN 60715	www.wago.com/210-114
	N° art.: 210-115 Rail acier; 35 x 7,5; épaisseur 1 mm; longueur 2 m; perforé; d'après EN 60715; Largeur de trou 18 mm; pas des trous 25 mm	www.wago.com/210-115
	N° art.: 210-118 Rail acier; 35 x 15; épaisseur 2,3 mm; longueur 2 m; non perforé; d'après EN 60715	www.wago.com/210-118
	N° art.: 210-196 Rail aluminium; 35 x 8,2; épaisseur 1,6 mm; longueur 2 m; non perforé; d'après EN 60715	www.wago.com/210-196
	N° art.: 210-197 Rail acier; 35 x 15; épaisseur 1,5 mm; longueur 2 m; perforé; d'après EN 60715	www.wago.com/210-197
	N° art.: 210-198 Rail en cuivre; 35 x 15; épaisseur 2,3 mm; longueur 2 m; non perforé; d'après EN 60715	www.wago.com/210-198

	N° art.: 210-504 Rail acier; 35 x 7,5; épaisseur 1 mm; longueur 2 m; perforé; galvanisation de bandes; d'après EN 60715	www.wago.com/210-504
	N° art.: 210-505 Rail acier; 35 x 7,5; épaisseur 1 mm; longueur 2 m; non perforé; galvanisation de bandes; d'après EN 60715	www.wago.com/210-505
	N° art.: 210-506 Rail acier; 35 x 15; épaisseur 1,5 mm; longueur 2 m; non perforé; galvanisation de bandes; d'après EN 60715	www.wago.com/210-506
	N° art.: 210-508 Rail acier; 35 x 15; épaisseur 1,5 mm; longueur 2 m; perforé; galvanisation de bandes; d'après EN 60715	www.wago.com/210-508

Marking accessories

	N° art.: 2009-145 Mini-WSB Inline; pour smartPRINTER; sur rouleau; extensible 5 - 5,2 MM; vierge; encliquetable	www.wago.com/2009-145
	N° art.: 2009-145/000-002 Mini-WSB Inline; sur rouleau; extensible 5 - 5,2 MM; vierge; encliquetable	www.wago.com/2009-145/000-002
	N° art.: 2009-145/000-005 Mini-WSB Inline; vierge; 1700 étiquettes Mini-WSB (5 mm) sur rouleau; extensible 5 - 5,2 MM	www.wago.com/2009-145/000-005
	N° art.: 2009-145/000-006 Mini-WSB Inline; pour smartPRINTER; sur rouleau; extensible 5 - 5,2 MM; vierge; encliquetable	www.wago.com/2009-145/000-006
	N° art.: 2009-145/000-007 Mini-WSB Inline; vierge; 1700 étiquettes Mini-WSB (5 mm) sur rouleau; extensible 5 - 5,2 MM	www.wago.com/2009-145/000-007
	N° art.: 2009-145/000-012 Mini-WSB Inline; pour smartPRINTER; sur rouleau; extensible 5 - 5,2 MM; vierge; encliquetable	www.wago.com/2009-145/000-012
	N° art.: 2009-145/000-023 Mini-WSB Inline; sur rouleau; extensible 5 - 5,2 MM; vierge; encliquetable	www.wago.com/2009-145/000-023
	N° art.: 2009-145/000-024 Mini-WSB Inline; sur rouleau; extensible 5 - 5,2 MM; vierge; encliquetable	www.wago.com/2009-145/000-024
	N° art.: 248-501 Système de repérage rapide Mini-WSB; vierge; Largeur d'étiquettes 5 mm; 10 bandes à 10 étiquettes par carte	www.wago.com/248-501
	N° art.: 248-501/000-002 Carte de repérage mini WSB; en carte; non extensible; vierge; encliquetable	www.wago.com/248-501/000-002
	N° art.: 248-501/000-005 Carte de repérage mini WSB; en carte; vierge; encliquetable	www.wago.com/248-501/000-005



N° art.: 248-501/000-006

Carte de repérage mini WSB; en carte; non extensible; vierge; encliquetable

www.wago.com/248-501/000-006



N° art.: 248-501/000-007

Carte de repérage mini WSB; en carte; non extensible; vierge; encliquetable

www.wago.com/248-501/000-007



N° art.: 248-501/000-012

Carte de repérage mini WSB; en carte; non extensible; vierge; encliquetable

www.wago.com/248-501/000-012



N° art.: 248-501/000-017

Carte de repérage mini WSB; en carte; non extensible; vierge; encliquetable

www.wago.com/248-501/000-017



N° art.: 248-501/000-023

Carte de repérage mini WSB; en carte; non extensible; vierge; encliquetable

www.wago.com/248-501/000-023



N° art.: 248-501/000-024

Carte de repérage mini WSB; en carte; non extensible; vierge; encliquetable

www.wago.com/248-501/000-024



N° art.: 750-100

Carte de repérage; en feuilles DIN A4; vierge

www.wago.com/750-100



N° art.: 750-103

Porte-étiquettes de groupe

www.wago.com/750-103



N° art.: 750-106

Porte-étiquettes de groupe

www.wago.com/750-106

Téléchargements

Documentation

Manual

4-channel, 0-10VDC, single-ended	V 1.3.0 Oct 5, 2015	PDF 2,0 MB	Téléchargement
----------------------------------	------------------------	---------------	----------------

Bid Text

750-468 IO-Klemmen	Jan 20, 2016	DOC 28,2 kB	Téléchargement
-----------------------	--------------	----------------	----------------

Additional Information

Disposal; Electrical and electronic equipment, Packaging	V 1.0.0 Oct 15, 2018	PDF 269,1 kB	Téléchargement
--	-------------------------	-----------------	----------------

System Description

Use in Hazardous Environments	V 1.0.0	PDF	Téléchargement
-------------------------------	---------	-----	----------------



Term definition, marking and installation regulations	May 8, 2014	1,0 MB	
750/753 Series I/O-System – General Product Information	Jun 19, 2013	704,3 kB	Téléchargement
Design Notes	V 2.0.1	PDF	Téléchargement
Basic conditions and recommendations for higher operational safety	May 3, 2011	1,8 MB	
Overview on WAGO-I/O-SYSTEM 750 approvals	Jun 19, 2013	196,6 kB	Téléchargement

smartDATA

CAD data

3D Download 750-468		URL	Téléchargement
---------------------	--	-----	----------------

Device Files

Device Driver

WAGO USB Service Cable Driver / 750 and 857 Series	6.5.3.0 Sep 10, 2014	ZIP 4,8 MB	Téléchargement
--	-------------------------	---------------	----------------

Famille de produits

750/753 Series I/O-System

[En savoir plus sur la famille de produits](#)

[Afficher tous les produits de la famille](#)

Sous réserve de modifications.