

**PB-DP SUB-D ZF TERM****Weidmüller Interface GmbH & Co. KG**

Klingenbergstraße 16

D-32758 Detmold

Germany

Fon: +49 5231 14-0

Fax: +49 5231 14-292083

www.weidmueller.com



Des longueurs de câble particulières sont de plus en plus souvent nécessaires. Pour répondre à ce nouveau besoin, Weidmüller propose une large gamme de connecteurs enfichables pour la libre confection.

**Informations générales de commande**

Type	PB-DP SUB-D ZF TERM
Référence	<a href="#">1161870000</a>
Version	
GTIN (EAN)	4032248950706
Cdt.	1 pièce(s)

**Fiche de données**

**PB-DP SUB-D ZF TERM**

**Weidmüller Interface GmbH & Co. KG**  
 Klingenbergstraße 16  
 D-32758 Detmold  
 Germany  
 Fon: +49 5231 14-0  
 Fax: +49 5231 14-292083  
 www.weidmueller.com

**Caractéristiques techniques**

**Dimensions et poids**

Poids net 91 g

**Températures**

Humidité Max. 75% à +25°C, pas de condensation

**Conformité environnementale du produit**

REACH SVHC Lead 7439-92-1

**Caractéristiques techniques pour connecteur SUB-D**

Angle de sortie	90°	BUS, interface câble	Raccordement à ressort
Connecteur enfichable, et brochage	Selon la spécification PROFIBUS	Cycles d'enfichage	≥ 200
Degré de protection	IP30	Humidité	Max. 75% à +25°C, pas de condensation
Interface BUS	D-Sub 9 pôles, Mâle	Matériau de base du boîtier	ZnAl
Plage de températures du coffret	-20...+70 ° C	Résistance de terminaison	Oui
Verrouillage	UNC4-40	Vitesse de transmission	12 MBit/s

**Classifications**

ETIM 4.0	EC002640	ETIM 5.0	EC002640
ETIM 6.0	EC001132	eClass 6.2	27-26-07-07
eClass 7.1	27-44-03-07	eClass 8.1	27-44-03-07
eClass 9.0	27-44-03-02	eClass 9.1	27-44-03-90

**Agréments**

Agréments



ROHS Conforme

**Téléchargements**

Brochure/Catalogue [CAT 8 SAI 15/16 EN](#)  
[FL FIELDWIRING EN](#)

**Fiche de données**

**PB-DP SUB-D ZF TERM**

**Weidmüller Interface GmbH & Co. KG**  
 Klingenbergstraße 16  
 D-32758 Detmold  
 Germany  
 Fon: +49 5231 14-0  
 Fax: +49 5231 14-292083  
 www.weidmueller.com

**Dessins**

**Schéma**

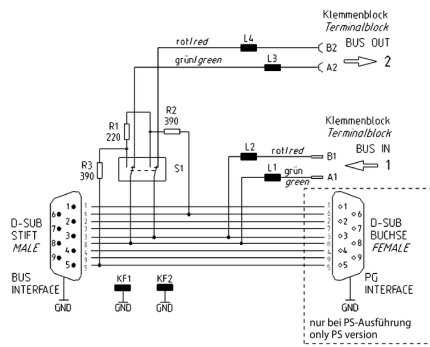

## Montageanleitung: PROFIBUS Bus-Stecker mit interner Kabelklemme



Eingang 1 und Ausgang 2	
L	(30)
L1	24
L2	7
L3	6

Art.-Nr.	Beschreibung	Abmessungen Busstecker
2433510000	PB-DP SUB-D ZF 180 TERM	62 x 31,6 x 14,8 mm

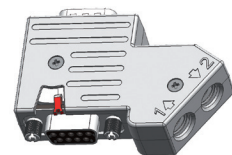

Eingang 1		Ausgang 2	
L	(30)	L	(35)
L1	24	L1	29
L2	7	L2	7
L3	6	L3	6

Art.-Nr.	Beschreibung	Abmessungen Busstecker
1173220000	PB-DP SUB-D ZF 35 TERM	64,6 x 42 x 16,8 mm
1173240000	PB-DP SUB-D ZF 35 TERM PS	64,6 x 42 x 16,8 mm

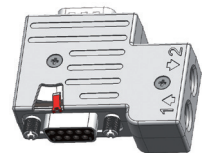

Eingang 1		Ausgang 2	
L	(35)	L	(30)
L1	29	L1	24
L2	7	L2	7
L3	6	L3	6

Art.-Nr.	Beschreibung	Abmessungen Busstecker
1161870000	PB-DP SUB-D ZF TERM	53,6 x 42 x 16,8 mm
1161880000	PB-DP SUB-D ZF T PS	53,6 x 42 x 16,8 mm

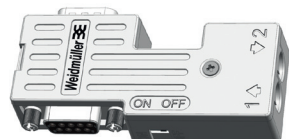

Eingang 1 und Ausgang 2	
L	(30)
L1	24
L2	7
L3	6

Art.-Nr.	Beschreibung	Abmessungen Busstecker
2004310000	PB-DP SUB-D ZF TERM S7	77,7 x 34,7 x 16,8 mm
2004320000	PB-DP SUB-D ZF T PS S7	77,7 x 34,7 x 16,8 mm

### Schaltbild

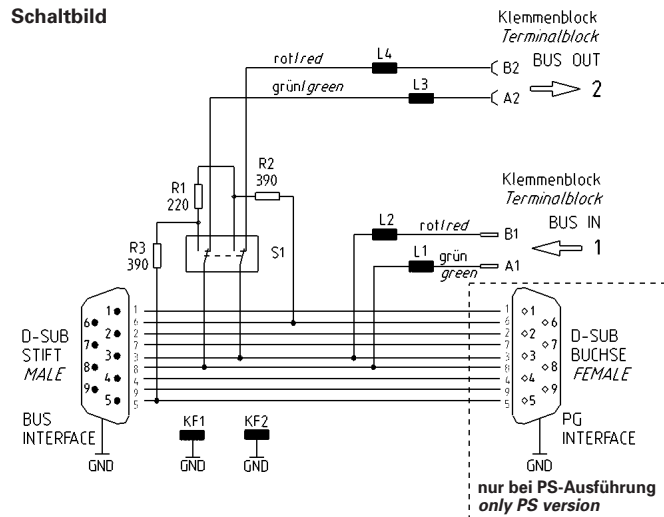

### Bus-Terminierung

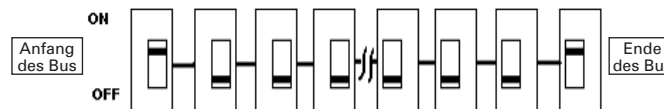

Diese Produkte sind für den Einsatz an Betriebsarten gemäß (National Electric Code) NFPA 79, bis Verschmutzungsgrad 2 zugelassen.

(Dargestellt 1173240000)



**Die Befestigungsschrauben lösen**  
mit Pozidriv-Schraubendreher PZ1

**Busstecker in geöffnetem Zustand**  
ohne Gehäuse-Deckel und ohne Schirmbügel.

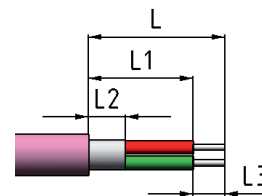
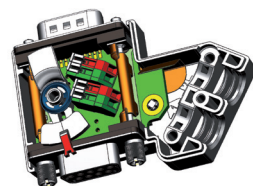

### Profibus-Kabelmantel gestuft abisolieren

(siehe Artikel)  
in einem Step mit mehrstufigen Abisolierwerkzeug (empfohlen Weidmüller CST vario) oder in mehreren Steps mit Standard-Abisolierwerkzeuge. Einzeladern abisolieren mit Abisolierzange (empfohlen Weidmüller STRIPAX).

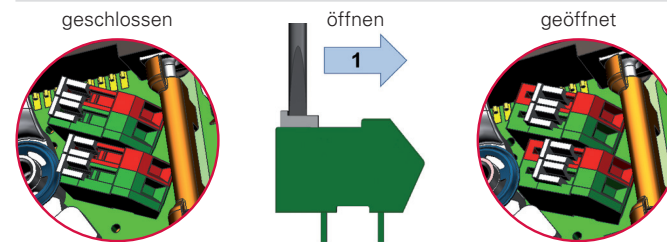

### Käfigzugfeder-Klemmen öffnen

Schraubendreher mit Klinge 2,5 x 0,4 in weiße Betätigungsschieber einführen und nach vorne schieben (Pfeil 1) in Richtung Kabelausgang.

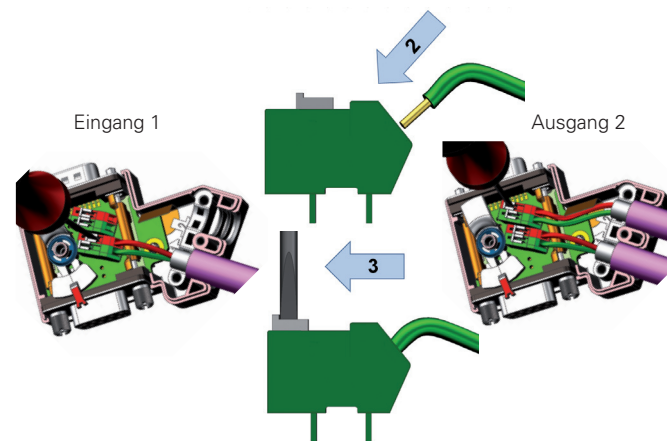

**Abisolierte Einzeladern für ankommendes Profibus-Kabel**  
jeweils in die Klemmen A1 und B1 einführen (Pfeil 2) und Käfigzugfederklemmen schließen (Pfeil 3).

**Abisolierte Einzeladern für abgehendes Profibus-Kabel**  
jeweils in die Klemmen A2 und B2 einführen (Pfeil 2) und Käfigzugfederklemmen schließen (Pfeil 3).

**Achtung! bei SPECIAL und COMPACT**  
Der Schalter für den Abschlusswiderstand darf nur betätigt werden solange der D-Sub Stecker nicht schraubverriegelt ist.

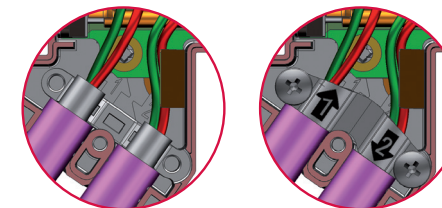

### Schirmbügel anziehen

Darauf achten, dass Kabelschirm flächig auf vorderer Kabelschirmauflage aufliegt (siehe linkes Bild). Die Befestigungsschrauben anziehen mit Pozidriv-Schraubendreher PZ1.  
Anzugsmoment: max. 0,3 Nm.

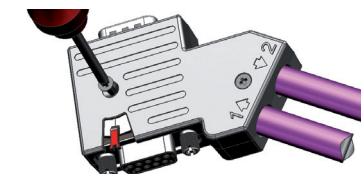

### Gehäusedeckel verriegeln

Die Befestigungsschrauben anziehen mit Pozidriv-Schraubendreher PZ1  
Anzugsmoment: max. 0,3 Nm.



### Bus-Terminierung (Abschlusswiderstände) Aus/Ein

Den Schalterhebel beim Busabschluss für aktive Terminierung in die Position „ON“ stellen. Für den eingangsseitigen Busabschluss beim 1. Teilnehmer, das abgehende Bus-Kabel auf der Eingangsseite (1) anschließen und den Schalterhebel in Position „ON“ stellen.

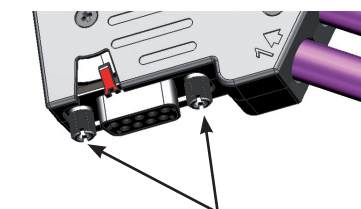

**Befestigung am D-Sub der Profibus-Schnittstelle**  
Anzugsmoment der Rändel-Verriegelungsschraube: max. 0,3 Nm.

## Mounting Instruction: PROFIBUS Bus Connectors with internal cable clamp

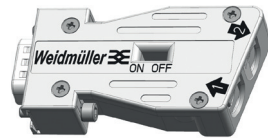

Input 1 and Output 2	
L	(30)
L1	24
L2	7
L3	6

Part No.	Description	Dimensions Bus Connector
2433510000	PB-DP SUB-D ZF 180 TERM	62 x 31,6 x 14,8 mm

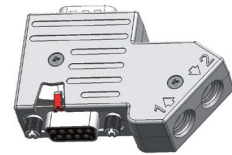

Input 1		Output 2	
L	(30)	L	(35)
L1	24	L1	29
L2	7	L2	7
L3	6	L3	6

Part No.	Description	Dimensions Bus Connector
1173220000	PB-DP SUB-D ZF 35 TERM	64,6 x 42 x 16,8 mm
1173240000	PB-DP SUB-D ZF 35 TERM PS	64,6 x 42 x 16,8 mm

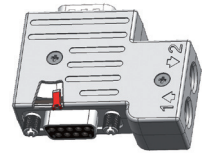

Input 1		Output 2	
L	(35)	L	(30)
L1	29	L1	24
L2	7	L2	7
L3	6	L3	6

Part No.	Description	Dimensions Bus Connector
1161870000	PB-DP SUB-D ZF TERM	53,6 x 42 x 16,8 mm
1161880000	PB-DP SUB-D ZF T PS	53,6 x 42 x 16,8 mm

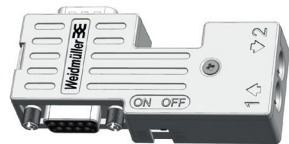

Input 1 and Output 2	
L	(30)
L1	24
L2	7
L3	6

Part No.	Description	Dimensions Bus Connector
2004310000	PB-DP SUB-D ZF TERM S7	77,7 x 34,7 x 16,8 mm
2004320000	PB-DP SUB-D ZF T PS S7	77,7 x 34,7 x 16,8 mm

### Circuit diagram

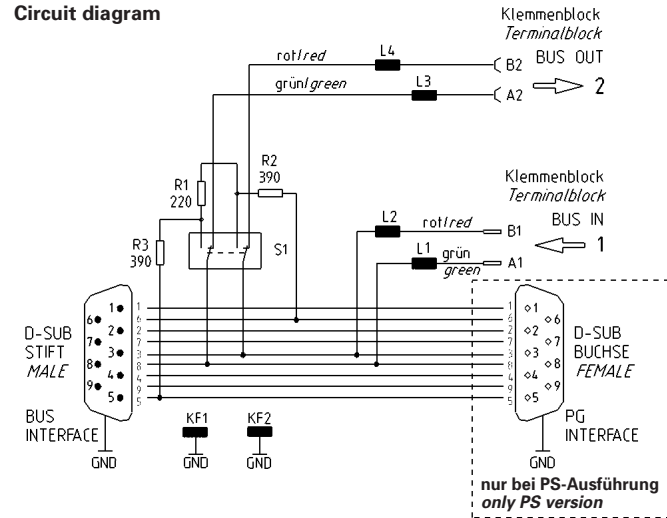

### Bus Termination

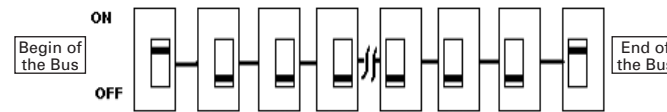

For use in NFPA 79 Applications only.  
Suitable for pollution degree 2 environment only.

(Shown 1173240000)

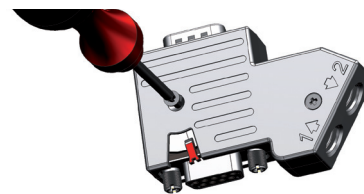

**Remove the 2 fixing screws**  
with Pozidriv screwdriver PZ1

**Bus connector in open condition**  
without housing cover and without  
shield clamp. Clamps: Position of white  
locking slide for clamp close or open.

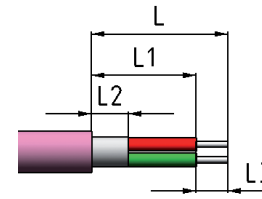
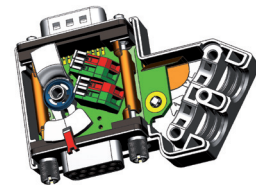

**Strip off Profibus cable in one step**  
with multi-stage strip off tool  
(recommended Weidmüller CST vario)  
or with standard strip off tool in a few steps.  
Strip off single wires to 6 +/-1mm and  
with strip tool (recommended Weidmüller  
STRIPAX).

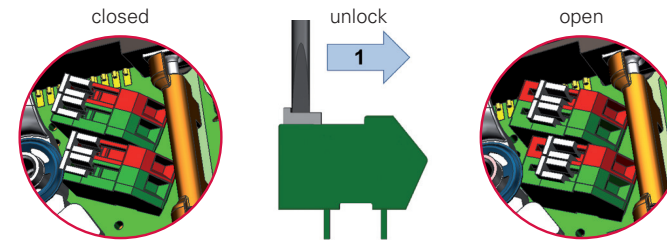

### Opening of cage clamp terminals

To open the terminals insert screwdriver with blade 2,5 x 0,4 into the  
white locking slide and move them forward (toward the cable output).

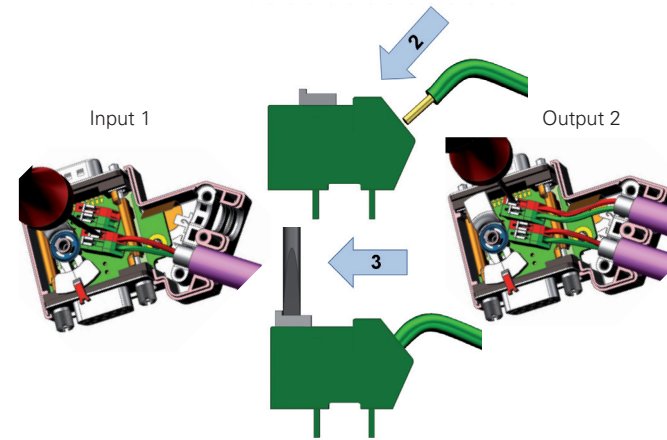

**Insert the cable wires for the  
terminals Profibus cable**  
into the clamps A1 and B1 (2) and  
close the terminals (3).

**Insert the cable wires for the  
outgoing Profibus cable**  
into A2 and B2 (2) and close the  
terminals (3).

**Attention! For SPECIAL and COMPACT**  
Only operate termination switch if the D-Sub connector is not screw  
locked.

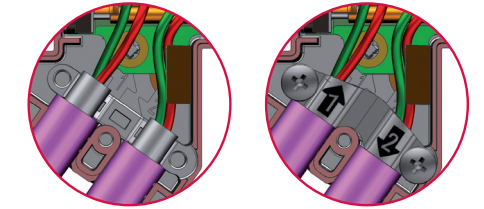

### Turn on shield clamp

Take care, that the cable shield lay fully on front cable shield support  
(see left picture). Lock on the 2 fixing screws with Pozidriv  
screwdriver PZ1.

Torque: max. 0,3 Nm.

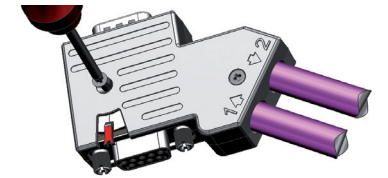

### Locking of housing cover

Tighten the 2 fixing screws with Pozidriv screwdriver PZ1  
Torque: max. 0,3 Nm.



### Bus termination (termination resistors) OFF/ON

For the bus termination with active termination move the switch lever to  
position "ON". For the bus termination for the 1st participant on the input  
side the output bus cable needs to be terminated on the input side (1) and  
move the switch lever to the position "ON".

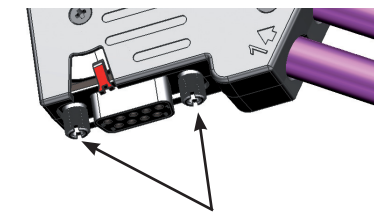

### Mounting on the D-Sub of the Profibus interface

Torque of knurled locking screw: max. 0,3 Nm.