

RoHS Compliant

BOMcheck.net

Couleur: ■

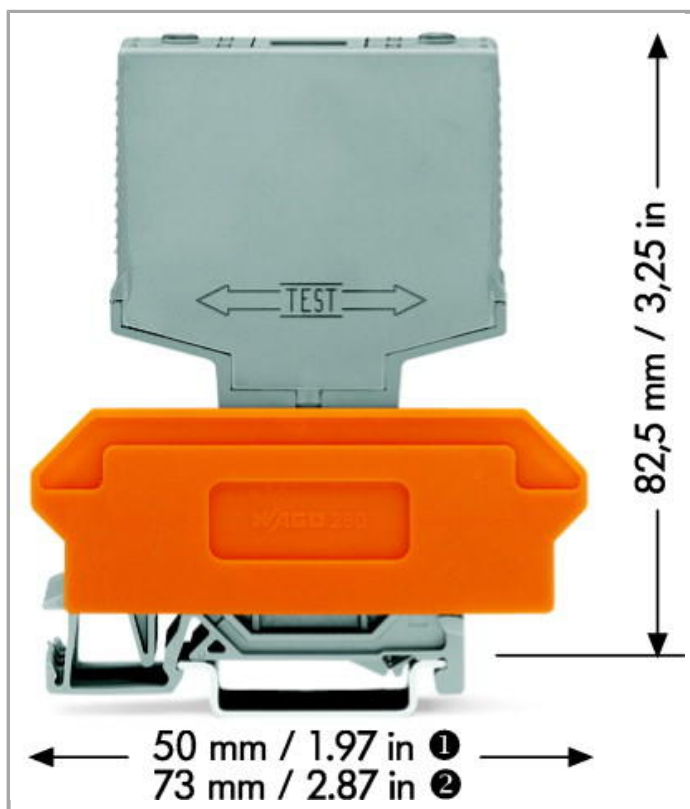

Données

Données techniques

Circuit de commande

Nominal input voltage U_N	24 VDC
Input voltage range	-30 ... +25 %
Courant d'entrée nominal I_N	7.4 mA

Circuit de charge

Nombre relais 1 R/contacts d'arrêt	1
Nombre relais 1 T/contacts de marche	1
Contact material (relay)	AgSnO ₂
Limiting continuous current	6 A
Max. make current (resistive)	1 s 15 A (AC)
Max. switching voltage	250 VAC
Max. switching power (resistive)	1500 VAAC
Temps de montée typ.	10 ms
Temps de relâchement	4 ms
Temps de rebondissement (typ.)	1 ms

Signaling

Indication d'état	LED red
-------------------	---------

Sécurité & Protection

Tension de référence	250 V
Tension assignée de tenue aux chocs	4 kV
Degré de pollution	2
Tension de claquage contact-bobine (AC, 1 min.)	3 kV _{rms}
Dielectric strength, control/load circuit (AC, 1 min)	3 kV _{rms}
Tension de claquage contact ouvert (AC, 1 min)	1 kV _{rms}
Dielectric strength open contact (AC, 1 min)	1 kV _{rms}
Tension de claquage, contact adjacent (AC, 1 min)	1.5 kV _{rms}
Dielectric strength, load/load circuit (AC, 1 min)	1.5 kV _{rms}
Indice de protection	IP20

Données géométriques

Largeur	20 mm / 0.787 inch
Profondeur à partir du niveau supérieur du rail	82,5 mm / 3.248 inch
Profondeur	52 mm / 1.654 inch

Données mécaniques

Type de montage	Module débrochable pour blocs de bornes de base
-----------------	---

Données du matériau

Couleur	gris
Charge calorifique	0.582 MJ
Poids	29.854 g

Conditions d'environnement

Température ambiante admissible Fonctionnement pour U _N	-25 ... 70 °C
Degré de pollution	2

Normes et spécifications



Normes/spécifications	EN 60664-1
-----------------------	------------

Dates commerciales









Country of origin	DE
GTIN	4017332426923
Customs Tariff No.	85364900990
Product Group	6 (Interface Electronics)

Produits correspondants

General accessories

	N° art.: 280-628 Bloc de bornes de base; 16 pôles; avec bornes pour 4 conducteurs; avec séparateur orange; Pour rail 35 x 15 et 35 x 7,5; 2,5 mm ²	www.wago.com/280-628
	N° art.: 280-638 Bloc de bornes de base; 8 pôles; avec bornes pour 2 conducteurs; avec séparateur orange; Pour rail 35 x 15 et 35 x 7,5; 2,5 mm ²	www.wago.com/280-638
	N° art.: 280-764 Bloc de bornes de base; 16 pôles; avec bornes pour 4 conducteurs; avec support de marquage avec; avec séparateur orange; Pour rail 35 x 15 et 35 x 7,5; 2,5 mm ²	www.wago.com/280-764

Marking accessories

	N° art.: 209-701 Carte de repérage WSB; en carte; non extensible; vierge; encliquetable	www.wago.com/209-701
	N° art.: 209-701/000-002 Carte de repérage WSB; en carte; non extensible; vierge; encliquetable	www.wago.com/209-701/000-002
	N° art.: 209-701/000-005 Carte de repérage WSB; en carte; non extensible; vierge; encliquetable	www.wago.com/209-701/000-005
	N° art.: 209-701/000-006 Carte de repérage WSB; en carte; non extensible; vierge; encliquetable	www.wago.com/209-701/000-006
	N° art.: 209-701/000-007 Carte de repérage WSB; en carte; non extensible; vierge; encliquetable	www.wago.com/209-701/000-007
	N° art.: 209-701/000-012 Carte de repérage WSB; en carte; non extensible; vierge; encliquetable	www.wago.com/209-701/000-012
	N° art.: 209-701/000-017 Carte de repérage WSB; en carte; non extensible; vierge; encliquetable	www.wago.com/209-701/000-017
	N° art.: 209-701/000-023 Carte de repérage WSB; en carte; non extensible; vierge; encliquetable	www.wago.com/209-701/000-023



N° art.: 209-701/000-024

Carte de repérage WSB; en carte; non extensible; vierge; encliquetable

www.wago.com/209-701/000-024

Téléchargements

Documentation

Bid Text

286-320/004-000 Relaisbaustein	Jan 22, 2016	DOC 27,1 kB	Téléchargement
-----------------------------------	--------------	----------------	----------------

Additional Information

Disposal; Electrical and electronic equipment, Packaging	V 1.0.0 Oct 15, 2018	PDF 269,1 kB	Téléchargement
--	-------------------------	-----------------	----------------

Sous réserve de modifications.