

Fiche technique | Numéro d'article: 286-336/001-000

Module relais; Tension nominale d'entrée DC 24 V; 2 T et 2 R; Indication d'état rouge; Largeur 25 mm

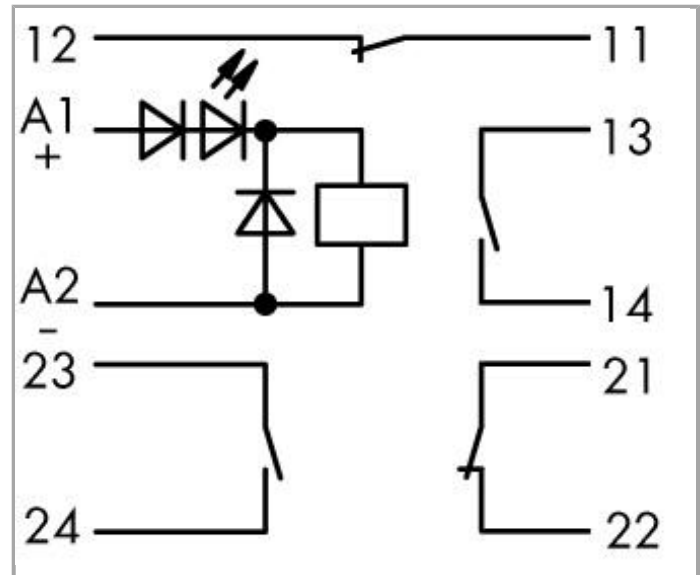

www.wago.com/286-336/001-000



RoHS Compliant

[BOMcheck.net](https://www.bomcheck.net)

Couleur: ■

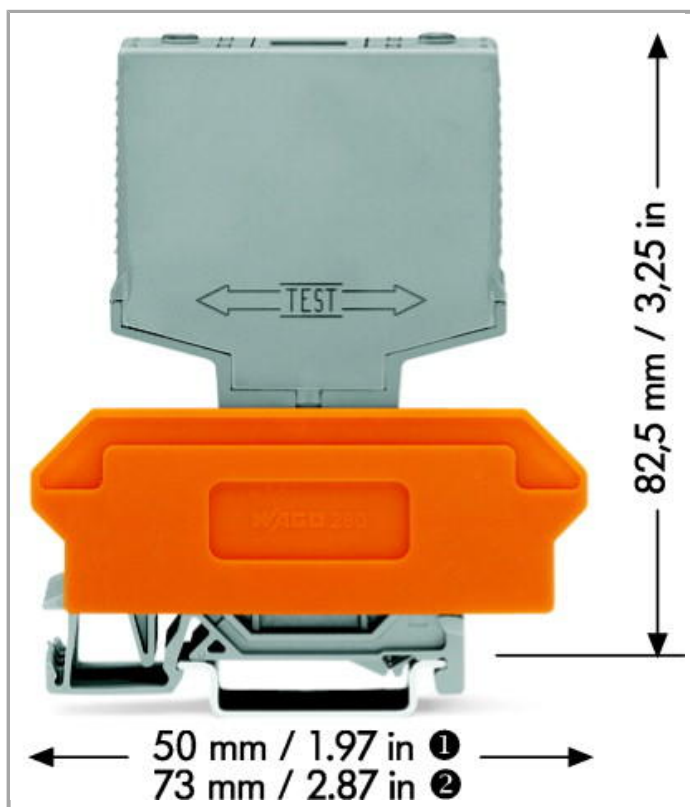

Données

Données techniques

Circuit de commande

Nominal input voltage U_N	24 VDC
Input voltage range	-30 ... +25 %
Courant d'entrée nominal I_N	8.5 mA

Circuit de charge

Nombre relais 1 R/contacts d'arrêt	2
Nombre relais 1 T/contacts de marche	2
Contact material (relay)	AgNi + Au
Limiting continuous current	5 A
Max. switching voltage	250 VAC
Temps de montée typ.	8 ms
Temps de relâchement	5 ms
Temps de rebondissement (typ.)	1 ms

Sécurité & Protection

Tension de référence	250 V
----------------------	-------

Tension assignée de tenue aux chocs	2.5 kV
Degré de pollution	2
Tension de claquage contact-bobine (AC, 1 min.)	1.5 kV _{rms}
Dielectric strength, control/load circuit (AC, 1 min)	1,5 kV _{rms}
Indice de protection	IP20

Données géométriques

Largeur	25 mm / 0.984 inch
Profondeur à partir du niveau supérieur du rail	82,5 mm / 3.248 inch
Profondeur	52 mm / 1.654 inch

Données mécaniques

Type de montage	Module débrochable pour blocs de bornes de base
-----------------	---

Données du matériau

Couleur	gris
Charge calorifique	0.867 MJ
Poids	41 g

Conditions d'environnement

Température ambiante admissible Fonctionnement pour U _N	-25 ... 70 °C
Degré de pollution	2

Normes et spécifications

Normes/spécifications	EN 60664-1
-----------------------	------------

Dates commerciales

Country of origin	DE
GTIN	4055143104746
Customs Tariff No.	85364900990
Product Group	6 (Interface Electronics)

Produits correspondants

Marking accessories



N° art.: 209-701

Carte de repérage WSB; en carte; non extensible; vierge; encliquetable







www.wago.com/209-701



N° art.: 209-701/000-002

Carte de repérage WSB; en carte; non extensible; vierge; encliquetable

www.wago.com/209-701/000-002

	N° art.: 209-701/000-005 Carte de repérage WSB; en carte; non extensible; vierge; encliquetable	www.wago.com/209-701/000-005
	N° art.: 209-701/000-006 Carte de repérage WSB; en carte; non extensible; vierge; encliquetable	www.wago.com/209-701/000-006
	N° art.: 209-701/000-007 Carte de repérage WSB; en carte; non extensible; vierge; encliquetable	www.wago.com/209-701/000-007
	N° art.: 209-701/000-012 Carte de repérage WSB; en carte; non extensible; vierge; encliquetable	www.wago.com/209-701/000-012
	N° art.: 209-701/000-017 Carte de repérage WSB; en carte; non extensible; vierge; encliquetable	www.wago.com/209-701/000-017
	N° art.: 209-701/000-023 Carte de repérage WSB; en carte; non extensible; vierge; encliquetable	www.wago.com/209-701/000-023
	N° art.: 209-701/000-024 Carte de repérage WSB; en carte; non extensible; vierge; encliquetable	www.wago.com/209-701/000-024

Téléchargements

Documentation

Bid Text

286-336/001-000 Relaisbaustein	Jan 22, 2016	DOC 27,6 kB	Téléchargement
-----------------------------------	--------------	----------------	----------------

Additional Information

Disposal; Electrical and electronic equipment, Packaging	V 1.0.0 Oct 15, 2018	PDF 269,1 kB	Téléchargement
--	-------------------------	-----------------	----------------

Sous réserve de modifications.