

Fiche technique | Numéro d'article: 788-354

Module relais; Tension nominale d'entrée DC 24 V; 1 RT; Limitation courant constant 16 A; pour charges de type lampes; Indication d'état rouge; Largeur 15 mm

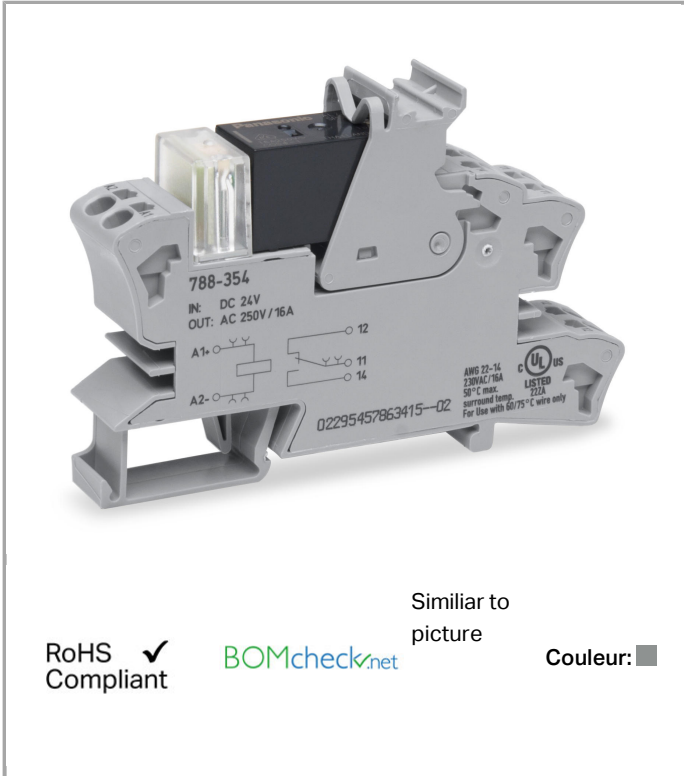

www.wago.com/788-354



Similar to picture

RoHS Compliant

BOMcheck.net

Couleur: ■

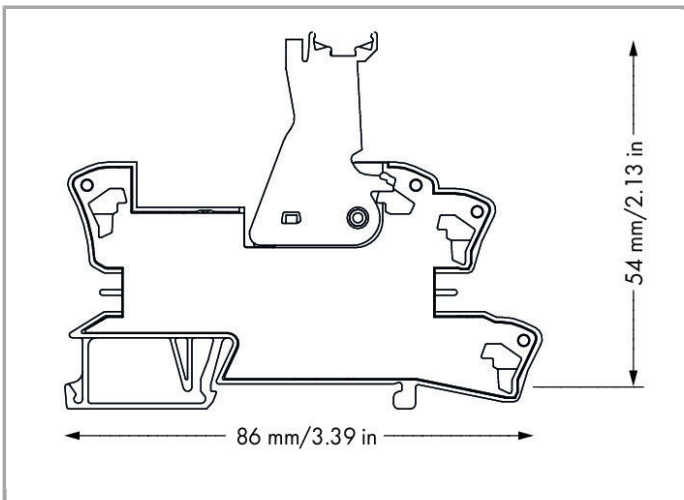
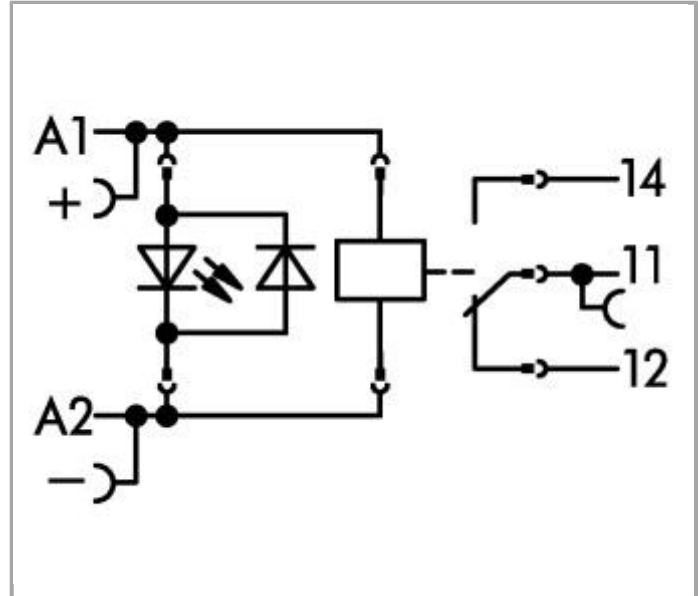

Description du produit :

Note:

Remarques :

- Isolation renforcée entre bobine et contacts

—

- Pour des tensions supérieures à 250 V entre modules relais connectés et pour respecter l'isolation renforcée, il faut utiliser un séparateur (par ex. 209-191).
- Un dispositif d'antiparasitage approprié doit être installé parallèlement aux charges inductives.

Données

Données techniques

Circuit de commande

Nominal input voltage U_N	24 VDC
Input voltage range	-15 ... +20 %
Courant d'entrée nominal IN	19 mA

Circuit de charge

Nombre relais 1 T/contacts inverseurs	1
Contact material (relay)	AgSnO ₂
Limiting continuous current	16 A
Max. make current (resistive)	0,05 s 120 A (AC)
Max. switching voltage	250 VAC
Max. switching power (resistive)	4000 VAAC; DC see load limit curve
Charge min. recommandée	5 V / 100 mA
Temps de montée typ.	15 ms
Temps de relâchement	5 ms
Electrical life (N.O.; resistive load; 23 °C)	100 x 10 ³ switching operations
Mechanical life (N.O.; resistive load; 23 °C)	10 x 10 ⁶ switching operations

Signaling

Indication d'état	LED red
-------------------	---------

Sécurité & Protection

Tension de référence	250 V
Tension assignée de tenue aux chocs	4 kV
Degré de pollution	3
Tension de claquage contact-bobine (AC, 1 min.)	5 kV _{rms}
Dielectric strength, control/load circuit (AC, 1 min)	5 kV _{rms}
Tension de claquage contact ouvert (AC, 1 min)	1 kV _{rms}
Dielectric strength open contact (AC, 1 min)	1 kV _{rms}
Indice de protection	IP20



Données de raccordement

Technique de connexion	Push-in CAGE CLAMP®
Conducteur rigide	0,34 ... 2,5 mm ² / 22 ... 14 AWG
Conducteur souple	0,34 ... 2,5 mm ² / 22 ... 14 AWG
Longueur de dénudage	9 ... 10 mm / 0.35 ... 0.39 inch

Données géométriques

Largeur	15 mm / 0.591 inch
Profondeur à partir du niveau supérieur du rail	54 mm / 2.126 inch
Profondeur	86 mm / 3.386 inch

Données mécaniques

Type de montage	Rail 35
-----------------	---------

Données du matériau

Couleur	gris
Charge calorifique	0.919 MJ
Poids	44.12 g

Conditions d'environnement

Température ambiante admissible Fonctionnement pour U _N	-40 ... 70 °C
Température ambiante (stockage)	-40 ... 70 °C
Degré de pollution	3

Normes et spécifications

Normes/spécifications	EN 61010-2-201; EN 61810-1; EN 61373; UL 508 (max. 10 A)
-----------------------	--

Dates commerciales

Country of origin	CN
GTIN	4055143184168
Customs Tariff No.	85364900990
Product Group	6 (Interface Electronics)

Autorisations / certificats

Approbations UL

Logo	Approbation	Nom du certificat
	UL International Netherlands B.V. (ORDINARY LOCATIONS)	E175199 Sec.6

Produits correspondants

tools

	N° art.: 210-720 Outil de manipulation, partiellement isolé; Type 2, lame (3,5 x 0,5) mm	www.wago.com/210-720
--	--	--

General accessories

	N° art.: 209-145 Porte-étiquettes de groupe	www.wago.com/209-145
--	---	--

	N° art.: 209-184 Protège-étiquettes	www.wago.com/209-184
--	---	--

	N° art.: 249-105 Porte-étiquettes de groupe	www.wago.com/249-105
--	---	--

	N° art.: 788-120 Accessoire pour module relais; Etat de fonctionnement rouge	www.wago.com/788-120
--	--	--

Jumper

	N° art.: 788-118 Peigne de pontage; 2 pôles (1-3); isolé	www.wago.com/788-118
---	--	--

	N° art.: 859-402 Peigne de pontage; 2 raccords; Courant nominal 18 A; isolé	www.wago.com/859-402
--	---	--

	N° art.: 859-402/000-005 Peigne de pontage; 2 raccords; Courant nominal 18 A; isolé	www.wago.com/859-402/000-005
--	---	--

	N° art.: 859-402/000-006 Peigne de pontage; 2 raccords; Courant nominal 18 A; isolé	www.wago.com/859-402/000-006
--	---	--

	N° art.: 859-402/000-029 Peigne de pontage; 2 raccords; Courant nominal 18 A; isolé	www.wago.com/859-402/000-029
--	---	--

















Marking accessories















	N° art.: 2009-110 Bandes de marquage; sur rouleau; non extensible; vierge; encliquetable	www.wago.com/2009-110
--	--	--

	N° art.: 2009-115 WMB-Inline; pour smartPRINTER; sur rouleau; extensible 5 - 5,2 MM; vierge; encliquetable	www.wago.com/2009-115
--	--	--

	N° art.: 2009-115/000-002 WMB-Inline; pour smartPRINTER; sur rouleau; extensible 5 - 5,2 MM; vierge; encliquetable	www.wago.com/2009-115/000-002
--	--	--

	N° art.: 2009-115/000-006 WMB-Inline; pour smartPRINTER; sur rouleau; extensible 5 - 5,2 MM; vierge; encliquetable	www.wago.com/2009-115/000-006
--	--	--

	N° art.: 2009-115/000-007 WMB-Inline; sur rouleau; extensible 5 - 5,2 MM; vierge; encliquetable	www.wago.com/2009-115/000-007
	N° art.: 2009-115/000-012 WMB-Inline; pour smartPRINTER; sur rouleau; extensible 5 - 5,2 MM; vierge; encliquetable	www.wago.com/2009-115/000-012
	N° art.: 2009-115/000-017 WMB-Inline; sur rouleau; extensible 5 - 5,2 MM; vierge; encliquetable	www.wago.com/2009-115/000-017
	N° art.: 2009-115/000-023 WMB-Inline; pour smartPRINTER; sur rouleau; extensible 5 - 5,2 MM; vierge; encliquetable	www.wago.com/2009-115/000-023
	N° art.: 209-128 Adaptateur	www.wago.com/209-128
	N° art.: 209-183 Étiquette à enficher	www.wago.com/209-183
	N° art.: 210-110 Stylo feutre-graveur	www.wago.com/210-110
	N° art.: 793-501 Carte de repérage WMB; en carte; non extensible; vierge; encliquetable	www.wago.com/793-501
	N° art.: 793-501/000-002 Carte de repérage WMB; en carte; non extensible; vierge; encliquetable	www.wago.com/793-501/000-002
	N° art.: 793-501/000-005 Carte de repérage WMB; en carte; non extensible; vierge; encliquetable	www.wago.com/793-501/000-005
	N° art.: 793-501/000-006 Carte de repérage WMB; en carte; non extensible; vierge; encliquetable	www.wago.com/793-501/000-006
	N° art.: 793-501/000-007 Carte de repérage WMB; en carte; non extensible; vierge; encliquetable	www.wago.com/793-501/000-007
	N° art.: 793-501/000-012 Carte de repérage WMB; en carte; non extensible; vierge; encliquetable	www.wago.com/793-501/000-012
	N° art.: 793-501/000-017 Carte de repérage WMB; en carte; non extensible; vierge; encliquetable	www.wago.com/793-501/000-017
	N° art.: 793-501/000-023 Carte de repérage WMB; en carte; non extensible; vierge; encliquetable	www.wago.com/793-501/000-023
	N° art.: 793-501/000-024 Carte de repérage WMB; en carte; non extensible; vierge; encliquetable	www.wago.com/793-501/000-024

	<p>N° art.: 793-502 Carte de repérage WMB; en carte; avec impression; 1 ... 10 (10x); non extensible; Impression horizontale; encliquetable</p>	www.wago.com/793-502
	<p>N° art.: 793-502/000-002 Carte de repérage WMB; en carte; avec impression; 1 ... 10 (10x); non extensible; Impression horizontale; encliquetable</p>	www.wago.com/793-502/000-002
	<p>N° art.: 793-502/000-005 Carte de repérage WMB; en carte; avec impression; 1 ... 10 (10x); non extensible; Impression horizontale; encliquetable</p>	www.wago.com/793-502/000-005
	<p>N° art.: 793-502/000-006 Carte de repérage WMB; en carte; avec impression; 1 ... 10 (10x); non extensible; Impression horizontale; encliquetable</p>	www.wago.com/793-502/000-006
	<p>N° art.: 793-502/000-007 Carte de repérage WMB; en carte; avec impression; 1 ... 10 (10x); non extensible; Impression horizontale; encliquetable</p>	www.wago.com/793-502/000-007
	<p>N° art.: 793-502/000-012 Carte de repérage WMB; en carte; avec impression; 1 ... 10 (10x); non extensible; Impression horizontale; encliquetable</p>	www.wago.com/793-502/000-012
	<p>N° art.: 793-502/000-017 Carte de repérage WMB; en carte; avec impression; 1 ... 10 (10x); non extensible; Impression horizontale; encliquetable</p>	www.wago.com/793-502/000-017
	<p>N° art.: 793-502/000-023 Carte de repérage WMB; en carte; avec impression; 1 ... 10 (10x); non extensible; Impression horizontale; encliquetable</p>	www.wago.com/793-502/000-023
	<p>N° art.: 793-502/000-024 Carte de repérage WMB; en carte; avec impression; 1 ... 10 (10x); non extensible; Impression horizontale; encliquetable</p>	www.wago.com/793-502/000-024
	<p>N° art.: 793-503 Carte de repérage WMB; en carte; avec impression; 11 ... 20 (10x); non extensible; Impression horizontale; encliquetable</p>	www.wago.com/793-503
	<p>N° art.: 793-503/000-002 Carte de repérage WMB; en carte; avec impression; 11 ... 20 (10x); non extensible; Impression horizontale; encliquetable</p>	www.wago.com/793-503/000-002
	<p>N° art.: 793-503/000-005 Carte de repérage WMB; en carte; avec impression; 11 ... 20 (10x); non extensible; Impression horizontale; encliquetable</p>	www.wago.com/793-503/000-005
	<p>N° art.: 793-503/000-006 Carte de repérage WMB; en carte; avec impression; 11 ... 20 (10x); non extensible; Impression horizontale; encliquetable</p>	www.wago.com/793-503/000-006
	<p>N° art.: 793-503/000-007 Carte de repérage WMB; en carte; avec impression; 11 ... 20 (10x); non extensible; Impression horizontale; encliquetable</p>	www.wago.com/793-503/000-007
	<p>N° art.: 793-503/000-012 Carte de repérage WMB; en carte; avec impression; 11 ... 20 (10x); non extensible; Impression horizontale; encliquetable</p>	www.wago.com/793-503/000-012

horizontale; encliquetable



N° art.: 793-503/000-017

Carte de repérage WMB; en carte; avec impression; 11 ... 20 (10x); non extensible; Impression horizontale; encliquetable

www.wago.com/793-503/000-017



N° art.: 793-503/000-023

Carte de repérage WMB; en carte; avec impression; 11 ... 20 (10x); non extensible; Impression horizontale; encliquetable

www.wago.com/793-503/000-023



N° art.: 793-503/000-024

Carte de repérage WMB; en carte; avec impression; 11 ... 20 (10x); non extensible; Impression horizontale; encliquetable

www.wago.com/793-503/000-024



N° art.: 793-504

Carte de repérage WMB; en carte; avec impression; 21 ... 30 (10x); non extensible; Impression horizontale; encliquetable

www.wago.com/793-504



N° art.: 793-504/000-002

Carte de repérage WMB; en carte; avec impression; 21 ... 30 (10x); non extensible; Impression horizontale; encliquetable

www.wago.com/793-504/000-002



N° art.: 793-504/000-005

Carte de repérage WMB; en carte; avec impression; 21 ... 30 (10x); non extensible; Impression horizontale; encliquetable

www.wago.com/793-504/000-005



N° art.: 793-504/000-006

Carte de repérage WMB; en carte; avec impression; 21 ... 30 (10x); non extensible; Impression horizontale; encliquetable

www.wago.com/793-504/000-006



N° art.: 793-504/000-012

Carte de repérage WMB; en carte; avec impression; 21 ... 30 (10x); non extensible; Impression horizontale; encliquetable

www.wago.com/793-504/000-012



N° art.: 793-504/000-017

Carte de repérage WMB; en carte; avec impression; 21 ... 30 (10x); non extensible; Impression horizontale; encliquetable

www.wago.com/793-504/000-017



N° art.: 793-504/000-023

Carte de repérage WMB; en carte; avec impression; 21 ... 30 (10x); non extensible; Impression horizontale; encliquetable

www.wago.com/793-504/000-023



N° art.: 793-505

Carte de repérage WMB; en carte; avec impression; 31 ... 40 (10x); non extensible; Impression horizontale; encliquetable

www.wago.com/793-505



N° art.: 793-505/000-005

Carte de repérage WMB; en carte; avec impression; 31 ... 40 (10x); non extensible; Impression horizontale; encliquetable

www.wago.com/793-505/000-005



N° art.: 793-505/000-006

Carte de repérage WMB; en carte; avec impression; 31 ... 40 (10x); non extensible; Impression horizontale; encliquetable

www.wago.com/793-505/000-006

















N° art.: 793-505/000-007

Carte de repérage WMB; en carte; avec impression; 31 ... 40 (10x); non extensible; Impression horizontale; encliquetable

www.wago.com/793-505/000-007

N° art.: 793-505/000-012

Carte de repérage WMB; en carte; avec impression; 31 ... 40 (10x); non extensible; Impression

	horizontale; encliquetable	www.wago.com/793-505/000-012
	N° art.: 793-506 Carte de repérage WMB; en carte; avec impression; 41 ... 50 (10x); non extensible; Impression horizontale; encliquetable	www.wago.com/793-506
	N° art.: 793-506/000-005 Carte de repérage WMB; en carte; avec impression; 41 ... 50 (10x); non extensible; Impression horizontale; encliquetable	www.wago.com/793-506/000-005
	N° art.: 793-506/000-006 Carte de repérage WMB; en carte; avec impression; 41 ... 50 (10x); non extensible; Impression horizontale; encliquetable	www.wago.com/793-506/000-006
	N° art.: 793-506/000-012 Carte de repérage WMB; en carte; avec impression; 41 ... 50 (10x); non extensible; Impression horizontale; encliquetable	www.wago.com/793-506/000-012
	N° art.: 793-506/000-017 Carte de repérage WMB; en carte; avec impression; 41 ... 50 (10x); non extensible; Impression horizontale; encliquetable	www.wago.com/793-506/000-017
	N° art.: 793-5501 Carte de repérage WMB; en carte; largeur des bornes 5 - 17,5 mm; extensible 5 - 5,2 MM; vierge; encliquetable	www.wago.com/793-5501
	N° art.: 793-5501/000-002 Carte de repérage WMB; en carte; largeur des bornes 5 - 17,5 mm; extensible 5 - 5,2 MM; vierge; encliquetable	www.wago.com/793-5501/000-002
	N° art.: 793-5501/000-005 Carte de repérage WMB; en carte; extensible 5 - 5,2 MM; vierge; encliquetable	www.wago.com/793-5501/000-005
	N° art.: 793-5501/000-006 Carte de repérage WMB; en carte; extensible 5 - 5,2 MM; vierge; encliquetable	www.wago.com/793-5501/000-006
	N° art.: 793-5501/000-007 Carte de repérage WMB; en carte; extensible 5 - 5,2 MM; vierge; encliquetable	www.wago.com/793-5501/000-007
	N° art.: 793-5501/000-012 Carte de repérage WMB; en carte; extensible 5 - 5,2 MM; vierge; encliquetable	www.wago.com/793-5501/000-012
	N° art.: 793-5501/000-014 Carte de repérage WMB; en carte; extensible 5 - 5,2 MM; vierge; encliquetable	www.wago.com/793-5501/000-014
	N° art.: 793-5501/000-017 Carte de repérage WMB; en carte; extensible 5 - 5,2 MM; vierge; encliquetable	www.wago.com/793-5501/000-017
	N° art.: 793-5501/000-023 Carte de repérage WMB; en carte; extensible 5 - 5,2 MM; vierge; encliquetable	www.wago.com/793-5501/000-023



N° art.: 793-5501/000-024

Carte de repérage WMB; en carte; extensible 5 - 5,2 MM; vierge; encliquetable

www.wago.com/793-5501/000-024



N° art.: 793-566

Carte de repérage WMB; en carte; avec impression; 1 ... 50 (2x); non extensible; Impression horizontale; encliquetable

www.wago.com/793-566



N° art.: 793-566/000-002

Carte de repérage WMB; en carte; avec impression; 1 ... 50 (2x); non extensible; Impression horizontale; encliquetable

www.wago.com/793-566/000-002



N° art.: 793-566/000-005

Carte de repérage WMB; en carte; avec impression; 1 ... 50 (2x); non extensible; Impression horizontale; encliquetable

www.wago.com/793-566/000-005



N° art.: 793-566/000-006

Carte de repérage WMB; en carte; avec impression; 1 ... 50 (2x); non extensible; Impression horizontale; encliquetable

www.wago.com/793-566/000-006



N° art.: 793-566/000-007

Carte de repérage WMB; en carte; avec impression; 1 ... 50 (2x); non extensible; Impression horizontale; encliquetable

www.wago.com/793-566/000-007



N° art.: 793-566/000-012

Carte de repérage WMB; en carte; avec impression; 1 ... 50 (2x); non extensible; Impression horizontale; encliquetable

www.wago.com/793-566/000-012



N° art.: 793-566/000-017

Carte de repérage WMB; en carte; avec impression; 1 ... 50 (2x); non extensible; Impression horizontale; encliquetable

www.wago.com/793-566/000-017



N° art.: 793-566/000-023

Carte de repérage WMB; en carte; avec impression; 1 ... 50 (2x); non extensible; Impression horizontale; encliquetable

www.wago.com/793-566/000-023



N° art.: 793-566/000-024

Carte de repérage WMB; en carte; avec impression; 1 ... 50 (2x); non extensible; Impression horizontale; encliquetable

www.wago.com/793-566/000-024

ferrule



N° art.: 216-241

Embout d'extrémité; embout pour 0,5 mm² / AWG 22; avec isolation plastique; étamés par électrolyse; Cuivre électrolytique; serti de manière étanche aux gaz; selon DIN 46228, partie 4/09.90

www.wago.com/216-241



N° art.: 216-242

Embout d'extrémité; embout pour 0,75 mm² / AWG 20; avec isolation plastique; étamés par électrolyse; Cuivre électrolytique; serti de manière étanche aux gaz; selon DIN 46228, partie 4/09.90

www.wago.com/216-242



N° art.: 216-243

Embout d'extrémité; embout pour 1 mm² / AWG 18; avec isolation plastique; étamés par électrolyse; Cuivre électrolytique; serti de manière étanche aux gaz; selon DIN 46228, partie 4/09.90

www.wago.com/216-243



N° art.: 216-244

Embout d'extrémité; embout pour 1,5 mm² / AWG 16; avec isolation plastique; étamés par électrolyse; Cuivre électrolytique; serti de manière étanche aux gaz; selon DIN 46228, partie 4/09.90

www.wago.com/216-244



N° art.: 216-542

Embout d'extrémité double; Embout pour 2 x 1 mm² / AWG 2 x 18; rouge, isolé; longueur 12 mm

www.wago.com/216-542



Téléchargements

Documentation

Bid Text

788-354 Relaisbaustein	Jan 15, 2016	DOC 27,6 kB	Téléchargement
---------------------------	--------------	----------------	----------------

Instruction Leaflet

Socket with Relay or SSR	Sep 28, 2015	PDF 2,1 MB	Téléchargement
--------------------------	--------------	---------------	----------------

Additional Information

Disposal; Electrical and electronic equipment, Packaging	V 1.0.0 Oct 15, 2018	PDF 269,1 kB	Téléchargement
--	-------------------------	-----------------	----------------

smartDATA

CAD data

3D Download 788-354		URL	Téléchargement
---------------------	--	-----	----------------

Sous réserve de modifications.