

# Fiche technique | Numéro d'article: 788-384

module relais avec contacts à guidage forcé; Tension nominale d'entrée DC 24 V; 2 RT; Limitation courant constant 8 A; Indication d'état rouge; Largeur 15 mm

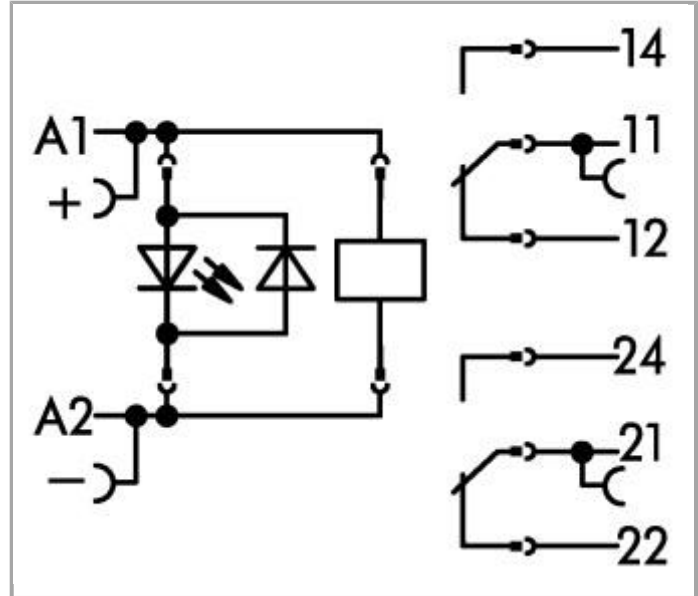

[www.wago.com/788-384](http://www.wago.com/788-384)

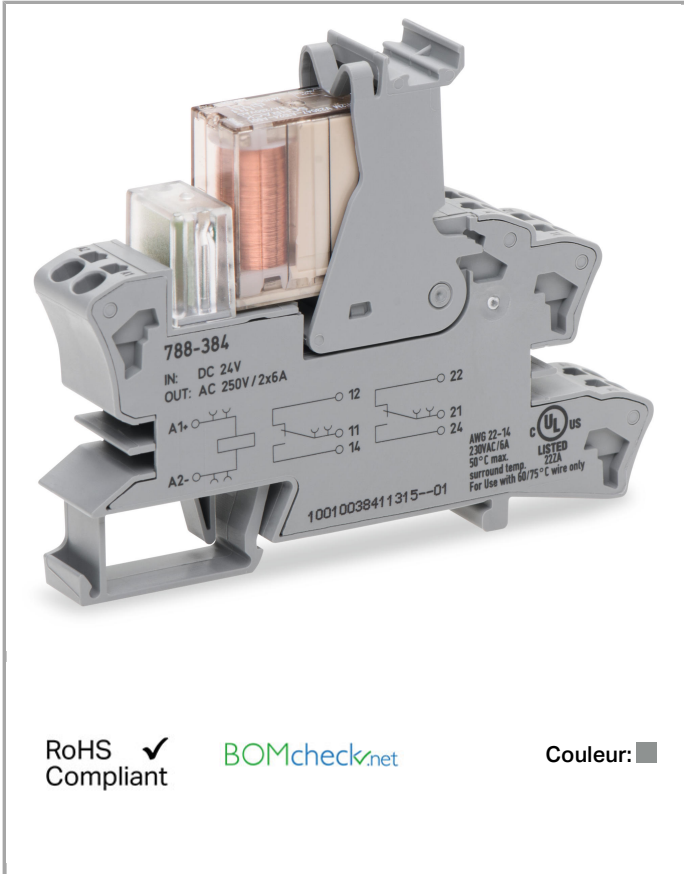

RoHS  Compliant

[BOMcheck.net](http://BOMcheck.net)

Couleur: ■

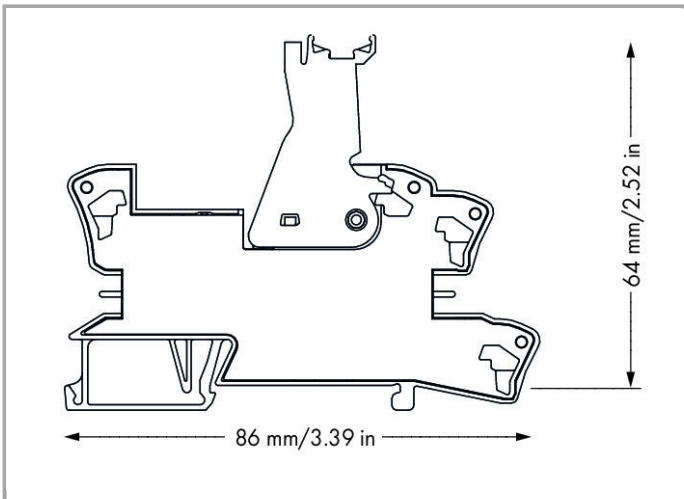

Description du produit :

Note:

## Remarques :

- Selon la norme EN 50205 seulement 1 contact T et 1 contact R doivent être utilisés pour les circuits de sécurité (11-14 et 22-21 ou 12-11 et 21-24)
- Isolation renforcée entre bobine et contacts
- Pour des tensions supérieures à 250 V entre modules relais connectés et pour respecter l'isolation renforcée, il faut utiliser un séparateur (par ex. 209-191).
- Un dispositif d'antiparasitage approprié doit être installé parallèlement aux charges inductives.

## Données

## Données techniques

## Circuit de commande

Nominal input voltage $U_N$	24 VDC
Input voltage range	-15 ... +10 %
Courant d'entrée nominal IN	31 mA

## Circuit de charge

Nombre relais 1 T/contacts inverseurs	2
Contact material (relay)	AgNi
Limiting continuous current	6 A
Max. make current (resistive)	4 s 14 A (AC)
Max. switching voltage	250 VAC
Max. switching power (resistive)	1500 VAAC; DC see load limit curve
Switching capacity	AC-15: 3 A / 250 VAC; DC-13: 3 A / 24 VDC
Charge min. recommandée	5 V / 10 mA
Temps de montée typ.	10 ms
Temps de relâchement	4 ms
Electrical life (N.O.; resistive load; 23 °C)	100 x 10 <sup>3</sup> switching operations
Mechanical life (N.O.; resistive load; 23 °C)	10 x 10 <sup>6</sup> switching operations
Max. switching load with load/without load	6 min <sup>-1</sup> / 300 min <sup>-1</sup>

## Signaling

Indication d'état	LED red
-------------------	---------

## Sécurité &amp; Protection

Tension de référence	250 V
Tension assignée de tenue aux chocs	4 kV
Degré de pollution	3
Tension de claquage contact-bobine (AC, 1 min.)	

	4 kV <sub>rms</sub>
Dielectric strength, control/load circuit (AC, 1 min)	4 kV <sub>rms</sub>
Tension de claquage contact ouvert (AC, 1 min)	1.5 kV <sub>rms</sub>
Dielectric strength open contact (AC, 1 min)	1,5 kV <sub>rms</sub>
Tension de claquage, contact adjacent (AC, 1 min)	3 kV <sub>rms</sub>
Dielectric strength, load/load circuit (AC, 1 min)	3 kV <sub>rms</sub>
Indice de protection	IP20

### Données de raccordement

Technique de connexion	Push-in CAGE CLAMP®
Conducteur rigide	0,34 ... 2,5 mm <sup>2</sup> / 22 ... 14 AWG
Conducteur souple	0,34 ... 2,5 mm <sup>2</sup> / 22 ... 14 AWG
Longueur de dénudage	9 ... 10 mm / 0.35 ... 0.39 inch

### Données géométriques

Largeur	15 mm / 0.591 inch
Profondeur à partir du niveau supérieur du rail	64 mm / 2.52 inch
Profondeur	86 mm / 3.386 inch

### Données mécaniques

Type de montage	Rail 35
-----------------	---------

### Données du matériau

Couleur	gris
Charge calorifique	0.947 MJ
Poids	50.3 g

### Conditions d'environnement

Température ambiante admissible Fonctionnement pour U <sub>N</sub>	-25 ... 75 °C
Température ambiante (stockage)	-40 ... 70 °C
Degré de pollution	3

### Normes et spécifications

Normes/spécifications	EN 61010-2-201; EN 61810-1; EN 61373; UL 508
-----------------------	--

## Dates commerciales

Country of origin	CN
GTIN	4055143184175
Customs Tariff No.	85364900990
Product Group	6 (Interface Electronics)

## Autorisations / certificats

### Approbations UL





Logo	Approbation	Nom du certificat
	UL UL International Netherlands B.V. (ORDINARY LOCATIONS)	E175199 Sec.6

## Produits correspondants



### tools

















	<b>N° art.: 210-720</b> Outil de manipulation, partiellement isolé; Type 2, lame (3,5 x 0,5) mm	<a href="http://www.wago.com/210-720">www.wago.com/210-720</a>
--	--	--

### Jumper

	<b>N° art.: 788-118</b> Peigne de pontage; 2 pôles (1-3); isolé	<a href="http://www.wago.com/788-118">www.wago.com/788-118</a>
	<b>N° art.: 859-402</b> Peigne de pontage; 2 raccords; Courant nominal 18 A; isolé	<a href="http://www.wago.com/859-402">www.wago.com/859-402</a>
	<b>N° art.: 859-402/000-005</b> Peigne de pontage; 2 raccords; Courant nominal 18 A; isolé	<a href="http://www.wago.com/859-402/000-005">www.wago.com/859-402/000-005</a>
	<b>N° art.: 859-402/000-006</b> Peigne de pontage; 2 raccords; Courant nominal 18 A; isolé	<a href="http://www.wago.com/859-402/000-006">www.wago.com/859-402/000-006</a>
	<b>N° art.: 859-402/000-029</b> Peigne de pontage; 2 raccords; Courant nominal 18 A; isolé	<a href="http://www.wago.com/859-402/000-029">www.wago.com/859-402/000-029</a>

### ferrule

	<b>N° art.: 216-241</b> Embout d'extrémité; embout pour 0,5 mm <sup>2</sup> / AWG 22; avec isolation plastique; étamés par électrolyse; Cuivre électrolytique; serti de manière étanche aux gaz; selon DIN 46228, partie 4/09.90	<a href="http://www.wago.com/216-241">www.wago.com/216-241</a>
	<b>N° art.: 216-242</b> Embout d'extrémité; embout pour 0,75 mm <sup>2</sup> / AWG 20; avec isolation plastique; étamés par électrolyse; Cuivre électrolytique; serti de manière étanche aux gaz; selon DIN 46228, partie 4/09.90	<a href="http://www.wago.com/216-242">www.wago.com/216-242</a>
	<b>N° art.: 216-243</b> Embout d'extrémité; embout pour 1 mm <sup>2</sup> / AWG 18; avec isolation plastique; étamés par électrolyse; Cuivre électrolytique; serti de manière étanche aux gaz; selon DIN 46228, partie 4/09.90	<a href="http://www.wago.com/216-243">www.wago.com/216-243</a>

	<p><b>N° art.: 216-244</b>                      Embout d'extrémité; embout pour 1,5 mm<sup>2</sup> / AWG 16; avec isolation plastique; étamés par électrolyse; Cuivre électrolytique; serti de manière étanche aux gaz; selon DIN 46228, partie 4/09.90</p>	<a href="http://www.wago.com/216-244">www.wago.com/216-244</a>
	<p><b>N° art.: 216-542</b>                      Embout d'extrémité double; Embout pour 2 x 1 mm<sup>2</sup> / AWG 2 x 18; rouge, isolé; longueur 12 mm</p>	<a href="http://www.wago.com/216-542">www.wago.com/216-542</a>
<b>Marking accessories</b>		
	<p><b>N° art.: 2009-110</b>                      Bandes de marquage; sur rouleau; non extensible; vierge; encliquetable</p>	<a href="http://www.wago.com/2009-110">www.wago.com/2009-110</a>
	<p><b>N° art.: 2009-115</b>                      WMB-Inline; pour smartPRINTER; sur rouleau; extensible 5 - 5,2 MM; vierge; encliquetable</p>	<a href="http://www.wago.com/2009-115">www.wago.com/2009-115</a>
	<p><b>N° art.: 2009-115/000-002</b>                      WMB-Inline; pour smartPRINTER; sur rouleau; extensible 5 - 5,2 MM; vierge; encliquetable</p>	<a href="http://www.wago.com/2009-115/000-002">www.wago.com/2009-115/000-002</a>
	<p><b>N° art.: 2009-115/000-006</b>                      WMB-Inline; pour smartPRINTER; sur rouleau; extensible 5 - 5,2 MM; vierge; encliquetable</p>	<a href="http://www.wago.com/2009-115/000-006">www.wago.com/2009-115/000-006</a>
	<p><b>N° art.: 2009-115/000-007</b>                      WMB-Inline; sur rouleau; extensible 5 - 5,2 MM; vierge; encliquetable</p>	<a href="http://www.wago.com/2009-115/000-007">www.wago.com/2009-115/000-007</a>
	<p><b>N° art.: 2009-115/000-012</b>                      WMB-Inline; pour smartPRINTER; sur rouleau; extensible 5 - 5,2 MM; vierge; encliquetable</p>	<a href="http://www.wago.com/2009-115/000-012">www.wago.com/2009-115/000-012</a>
	<p><b>N° art.: 2009-115/000-017</b>                      WMB-Inline; sur rouleau; extensible 5 - 5,2 MM; vierge; encliquetable</p>	<a href="http://www.wago.com/2009-115/000-017">www.wago.com/2009-115/000-017</a>
	<p><b>N° art.: 2009-115/000-023</b>                      WMB-Inline; pour smartPRINTER; sur rouleau; extensible 5 - 5,2 MM; vierge; encliquetable</p>	<a href="http://www.wago.com/2009-115/000-023">www.wago.com/2009-115/000-023</a>
	<p><b>N° art.: 209-128</b>                      Adaptateur</p>	<a href="http://www.wago.com/209-128">www.wago.com/209-128</a>
	<p><b>N° art.: 209-183</b>                      Étiquette à enficher</p>	<a href="http://www.wago.com/209-183">www.wago.com/209-183</a>
	<p><b>N° art.: 210-110</b>                      Stylo feutre-graveur</p>	<a href="http://www.wago.com/210-110">www.wago.com/210-110</a>
	<p><b>N° art.: 793-501</b>                      Carte de repérage WMB; en carte; non extensible; vierge; encliquetable</p>	<a href="http://www.wago.com/793-501">www.wago.com/793-501</a>
	<p><b>N° art.: 793-501/000-002</b>                      Carte de repérage WMB; en carte; non extensible; vierge; encliquetable</p>	<a href="http://www.wago.com/793-501/000-002">www.wago.com/793-501/000-002</a>
	<p><b>N° art.: 793-501/000-005</b>                      Carte de repérage WMB; en carte; non extensible; vierge; encliquetable</p>	<a href="http://www.wago.com/793-501/000-005">www.wago.com/793-501/000-005</a>



**N° art.: 793-501/000-006**  
Carte de repérage WMB; en carte; non extensible; vierge; encliquetable

[www.wago.com/793-501/000-006](http://www.wago.com/793-501/000-006)



**N° art.: 793-501/000-007**  
Carte de repérage WMB; en carte; non extensible; vierge; encliquetable

[www.wago.com/793-501/000-007](http://www.wago.com/793-501/000-007)



**N° art.: 793-501/000-012**  
Carte de repérage WMB; en carte; non extensible; vierge; encliquetable

[www.wago.com/793-501/000-012](http://www.wago.com/793-501/000-012)



**N° art.: 793-501/000-017**  
Carte de repérage WMB; en carte; non extensible; vierge; encliquetable

[www.wago.com/793-501/000-017](http://www.wago.com/793-501/000-017)



**N° art.: 793-501/000-023**  
Carte de repérage WMB; en carte; non extensible; vierge; encliquetable

[www.wago.com/793-501/000-023](http://www.wago.com/793-501/000-023)



**N° art.: 793-501/000-024**  
Carte de repérage WMB; en carte; non extensible; vierge; encliquetable

[www.wago.com/793-501/000-024](http://www.wago.com/793-501/000-024)



**N° art.: 793-502**  
Carte de repérage WMB; en carte; avec impression; 1 ... 10 (10x); non extensible; Impression horizontale; encliquetable

[www.wago.com/793-502](http://www.wago.com/793-502)



**N° art.: 793-502/000-002**  
Carte de repérage WMB; en carte; avec impression; 1 ... 10 (10x); non extensible; Impression horizontale; encliquetable

[www.wago.com/793-502/000-002](http://www.wago.com/793-502/000-002)



**N° art.: 793-502/000-005**  
Carte de repérage WMB; en carte; avec impression; 1 ... 10 (10x); non extensible; Impression horizontale; encliquetable

[www.wago.com/793-502/000-005](http://www.wago.com/793-502/000-005)



**N° art.: 793-502/000-006**  
Carte de repérage WMB; en carte; avec impression; 1 ... 10 (10x); non extensible; Impression horizontale; encliquetable

[www.wago.com/793-502/000-006](http://www.wago.com/793-502/000-006)



**N° art.: 793-502/000-007**  
Carte de repérage WMB; en carte; avec impression; 1 ... 10 (10x); non extensible; Impression horizontale; encliquetable

[www.wago.com/793-502/000-007](http://www.wago.com/793-502/000-007)



**N° art.: 793-502/000-012**  
Carte de repérage WMB; en carte; avec impression; 1 ... 10 (10x); non extensible; Impression horizontale; encliquetable

[www.wago.com/793-502/000-012](http://www.wago.com/793-502/000-012)



**N° art.: 793-502/000-017**  
Carte de repérage WMB; en carte; avec impression; 1 ... 10 (10x); non extensible; Impression horizontale; encliquetable

[www.wago.com/793-502/000-017](http://www.wago.com/793-502/000-017)

















**N° art.: 793-502/000-023**  
Carte de repérage WMB; en carte; avec impression; 1 ... 10 (10x); non extensible; Impression horizontale; encliquetable















[www.wago.com/793-502/000-023](http://www.wago.com/793-502/000-023)



**N° art.: 793-502/000-024**  
Carte de repérage WMB; en carte; avec impression; 1 ... 10 (10x); non extensible; Impression horizontale; encliquetable

[www.wago.com/793-502/000-024](http://www.wago.com/793-502/000-024)

	<p><b>N° art.: 793-503</b>                  Carte de repérage WMB; en carte; avec impression; 11 ... 20 (10x); non extensible; Impression horizontale; encliquetable</p>	<a href="http://www.wago.com/793-503">www.wago.com/793-503</a>
	<p><b>N° art.: 793-503/000-002</b>                  Carte de repérage WMB; en carte; avec impression; 11 ... 20 (10x); non extensible; Impression horizontale; encliquetable</p>	<a href="http://www.wago.com/793-503/000-002">www.wago.com/793-503/000-002</a>
	<p><b>N° art.: 793-503/000-005</b>                  Carte de repérage WMB; en carte; avec impression; 11 ... 20 (10x); non extensible; Impression horizontale; encliquetable</p>	<a href="http://www.wago.com/793-503/000-005">www.wago.com/793-503/000-005</a>
	<p><b>N° art.: 793-503/000-006</b>                  Carte de repérage WMB; en carte; avec impression; 11 ... 20 (10x); non extensible; Impression horizontale; encliquetable</p>	<a href="http://www.wago.com/793-503/000-006">www.wago.com/793-503/000-006</a>
	<p><b>N° art.: 793-503/000-007</b>                  Carte de repérage WMB; en carte; avec impression; 11 ... 20 (10x); non extensible; Impression horizontale; encliquetable</p>	<a href="http://www.wago.com/793-503/000-007">www.wago.com/793-503/000-007</a>
	<p><b>N° art.: 793-503/000-012</b>                  Carte de repérage WMB; en carte; avec impression; 11 ... 20 (10x); non extensible; Impression horizontale; encliquetable</p>	<a href="http://www.wago.com/793-503/000-012">www.wago.com/793-503/000-012</a>
	<p><b>N° art.: 793-503/000-017</b>                  Carte de repérage WMB; en carte; avec impression; 11 ... 20 (10x); non extensible; Impression horizontale; encliquetable</p>	<a href="http://www.wago.com/793-503/000-017">www.wago.com/793-503/000-017</a>
	<p><b>N° art.: 793-503/000-023</b>                  Carte de repérage WMB; en carte; avec impression; 11 ... 20 (10x); non extensible; Impression horizontale; encliquetable</p>	<a href="http://www.wago.com/793-503/000-023">www.wago.com/793-503/000-023</a>
	<p><b>N° art.: 793-503/000-024</b>                  Carte de repérage WMB; en carte; avec impression; 11 ... 20 (10x); non extensible; Impression horizontale; encliquetable</p>	<a href="http://www.wago.com/793-503/000-024">www.wago.com/793-503/000-024</a>
	<p><b>N° art.: 793-504</b>                  Carte de repérage WMB; en carte; avec impression; 21 ... 30 (10x); non extensible; Impression horizontale; encliquetable</p>	<a href="http://www.wago.com/793-504">www.wago.com/793-504</a>
	<p><b>N° art.: 793-504/000-002</b>                  Carte de repérage WMB; en carte; avec impression; 21 ... 30 (10x); non extensible; Impression horizontale; encliquetable</p>	<a href="http://www.wago.com/793-504/000-002">www.wago.com/793-504/000-002</a>
	<p><b>N° art.: 793-504/000-005</b>                  Carte de repérage WMB; en carte; avec impression; 21 ... 30 (10x); non extensible; Impression horizontale; encliquetable</p>	<a href="http://www.wago.com/793-504/000-005">www.wago.com/793-504/000-005</a>
	<p><b>N° art.: 793-504/000-006</b>                  Carte de repérage WMB; en carte; avec impression; 21 ... 30 (10x); non extensible; Impression horizontale; encliquetable</p>	<a href="http://www.wago.com/793-504/000-006">www.wago.com/793-504/000-006</a>
	<p><b>N° art.: 793-504/000-012</b>                  Carte de repérage WMB; en carte; avec impression; 21 ... 30 (10x); non extensible; Impression horizontale; encliquetable</p>	<a href="http://www.wago.com/793-504/000-012">www.wago.com/793-504/000-012</a>
	<p><b>N° art.: 793-504/000-017</b>                  Carte de repérage WMB; en carte; avec impression; 21 ... 30 (10x); non extensible; Impression horizontale; encliquetable</p>	<a href="http://www.wago.com/793-504/000-017">www.wago.com/793-504/000-017</a>

	<p><b>N° art.: 793-504/000-023</b>                      Carte de repérage WMB; en carte; avec impression; 21 ... 30 (10x); non extensible; Impression horizontale; encliquetable</p>	<a href="http://www.wago.com/793-504/000-023">www.wago.com/793-504/000-023</a>
	<p><b>N° art.: 793-505</b>                      Carte de repérage WMB; en carte; avec impression; 31 ... 40 (10x); non extensible; Impression horizontale; encliquetable</p>	<a href="http://www.wago.com/793-505">www.wago.com/793-505</a>
	<p><b>N° art.: 793-505/000-005</b>                      Carte de repérage WMB; en carte; avec impression; 31 ... 40 (10x); non extensible; Impression horizontale; encliquetable</p>	<a href="http://www.wago.com/793-505/000-005">www.wago.com/793-505/000-005</a>
	<p><b>N° art.: 793-505/000-006</b>                      Carte de repérage WMB; en carte; avec impression; 31 ... 40 (10x); non extensible; Impression horizontale; encliquetable</p>	<a href="http://www.wago.com/793-505/000-006">www.wago.com/793-505/000-006</a>
	<p><b>N° art.: 793-505/000-007</b>                      Carte de repérage WMB; en carte; avec impression; 31 ... 40 (10x); non extensible; Impression horizontale; encliquetable</p>	<a href="http://www.wago.com/793-505/000-007">www.wago.com/793-505/000-007</a>
	<p><b>N° art.: 793-505/000-012</b>                      Carte de repérage WMB; en carte; avec impression; 31 ... 40 (10x); non extensible; Impression horizontale; encliquetable</p>	<a href="http://www.wago.com/793-505/000-012">www.wago.com/793-505/000-012</a>
	<p><b>N° art.: 793-506</b>                      Carte de repérage WMB; en carte; avec impression; 41 ... 50 (10x); non extensible; Impression horizontale; encliquetable</p>	<a href="http://www.wago.com/793-506">www.wago.com/793-506</a>
	<p><b>N° art.: 793-506/000-005</b>                      Carte de repérage WMB; en carte; avec impression; 41 ... 50 (10x); non extensible; Impression horizontale; encliquetable</p>	<a href="http://www.wago.com/793-506/000-005">www.wago.com/793-506/000-005</a>
	<p><b>N° art.: 793-506/000-006</b>                      Carte de repérage WMB; en carte; avec impression; 41 ... 50 (10x); non extensible; Impression horizontale; encliquetable</p>	<a href="http://www.wago.com/793-506/000-006">www.wago.com/793-506/000-006</a>
	<p><b>N° art.: 793-506/000-012</b>                      Carte de repérage WMB; en carte; avec impression; 41 ... 50 (10x); non extensible; Impression horizontale; encliquetable</p>	<a href="http://www.wago.com/793-506/000-012">www.wago.com/793-506/000-012</a>
	<p><b>N° art.: 793-506/000-017</b>                      Carte de repérage WMB; en carte; avec impression; 41 ... 50 (10x); non extensible; Impression horizontale; encliquetable</p>	<a href="http://www.wago.com/793-506/000-017">www.wago.com/793-506/000-017</a>
	<p><b>N° art.: 793-5501</b>                      Carte de repérage WMB; en carte; largeur des bornes 5 - 17,5 mm; extensible 5 - 5,2 MM; vierge; encliquetable</p>	<a href="http://www.wago.com/793-5501">www.wago.com/793-5501</a>
	<p><b>N° art.: 793-5501/000-002</b>                      Carte de repérage WMB; en carte; largeur des bornes 5 - 17,5 mm; extensible 5 - 5,2 MM; vierge; encliquetable</p>	<a href="http://www.wago.com/793-5501/000-002">www.wago.com/793-5501/000-002</a>
	<p><b>N° art.: 793-5501/000-005</b>                      Carte de repérage WMB; en carte; extensible 5 - 5,2 MM; vierge; encliquetable</p>	<a href="http://www.wago.com/793-5501/000-005">www.wago.com/793-5501/000-005</a>
	<p><b>N° art.: 793-5501/000-006</b>                      Carte de repérage WMB; en carte; extensible 5 - 5,2 MM; vierge; encliquetable</p>	<a href="http://www.wago.com/793-5501/000-006">www.wago.com/793-5501/000-006</a>





**N° art.: 793-5501/000-007**  
Carte de repérage WMB; en carte; extensible 5 - 5,2 MM; vierge; encliquetable

[www.wago.com/793-5501/000-007](http://www.wago.com/793-5501/000-007)



**N° art.: 793-5501/000-012**  
Carte de repérage WMB; en carte; extensible 5 - 5,2 MM; vierge; encliquetable

[www.wago.com/793-5501/000-012](http://www.wago.com/793-5501/000-012)



**N° art.: 793-5501/000-014**  
Carte de repérage WMB; en carte; extensible 5 - 5,2 MM; vierge; encliquetable

[www.wago.com/793-5501/000-014](http://www.wago.com/793-5501/000-014)



**N° art.: 793-5501/000-017**  
Carte de repérage WMB; en carte; extensible 5 - 5,2 MM; vierge; encliquetable

[www.wago.com/793-5501/000-017](http://www.wago.com/793-5501/000-017)



**N° art.: 793-5501/000-023**  
Carte de repérage WMB; en carte; extensible 5 - 5,2 MM; vierge; encliquetable

[www.wago.com/793-5501/000-023](http://www.wago.com/793-5501/000-023)



**N° art.: 793-5501/000-024**  
Carte de repérage WMB; en carte; extensible 5 - 5,2 MM; vierge; encliquetable

[www.wago.com/793-5501/000-024](http://www.wago.com/793-5501/000-024)



**N° art.: 793-566**  
Carte de repérage WMB; en carte; avec impression; 1 ... 50 (2x); non extensible; Impression horizontale; encliquetable

[www.wago.com/793-566](http://www.wago.com/793-566)



**N° art.: 793-566/000-002**  
Carte de repérage WMB; en carte; avec impression; 1 ... 50 (2x); non extensible; Impression horizontale; encliquetable

[www.wago.com/793-566/000-002](http://www.wago.com/793-566/000-002)



**N° art.: 793-566/000-005**  
Carte de repérage WMB; en carte; avec impression; 1 ... 50 (2x); non extensible; Impression horizontale; encliquetable

[www.wago.com/793-566/000-005](http://www.wago.com/793-566/000-005)



**N° art.: 793-566/000-006**  
Carte de repérage WMB; en carte; avec impression; 1 ... 50 (2x); non extensible; Impression horizontale; encliquetable

[www.wago.com/793-566/000-006](http://www.wago.com/793-566/000-006)



**N° art.: 793-566/000-007**  
Carte de repérage WMB; en carte; avec impression; 1 ... 50 (2x); non extensible; Impression horizontale; encliquetable

[www.wago.com/793-566/000-007](http://www.wago.com/793-566/000-007)



**N° art.: 793-566/000-012**  
Carte de repérage WMB; en carte; avec impression; 1 ... 50 (2x); non extensible; Impression horizontale; encliquetable

[www.wago.com/793-566/000-012](http://www.wago.com/793-566/000-012)



**N° art.: 793-566/000-017**  
Carte de repérage WMB; en carte; avec impression; 1 ... 50 (2x); non extensible; Impression horizontale; encliquetable

[www.wago.com/793-566/000-017](http://www.wago.com/793-566/000-017)



**N° art.: 793-566/000-023**  
Carte de repérage WMB; en carte; avec impression; 1 ... 50 (2x); non extensible; Impression horizontale; encliquetable

[www.wago.com/793-566/000-023](http://www.wago.com/793-566/000-023)



**N° art.: 793-566/000-024**  
Carte de repérage WMB; en carte; avec impression; 1 ... 50 (2x); non extensible; Impression horizontale; encliquetable

[www.wago.com/793-566/000-024](http://www.wago.com/793-566/000-024)

## General accessories

	N° art.: 209-145 Porte-étiquettes de groupe	<a href="http://www.wago.com/209-145">www.wago.com/209-145</a>
	N° art.: 209-184 Protège-étiquettes	<a href="http://www.wago.com/209-184">www.wago.com/209-184</a>
	N° art.: 249-105 Porte-étiquettes de groupe	<a href="http://www.wago.com/249-105">www.wago.com/249-105</a>
	N° art.: 788-120 Accessoire pour module relais; Etat de fonctionnement rouge	<a href="http://www.wago.com/788-120">www.wago.com/788-120</a>

## Téléchargements

## Documentation

## Bid Text

788-384 Relaisbaustein	Jan 15, 2016	DOC 28,7 kB	Téléchargement
---------------------------	--------------	----------------	----------------

## Instruction Leaflet

Socket with Relay or SSR	Sep 28, 2015	PDF 2,1 MB	Téléchargement
--------------------------	--------------	---------------	----------------

## Additional Information

Disposal; Electrical and electronic equipment, Packaging	V 1.0.0 Oct 15, 2018	PDF 269,1 kB	Téléchargement
--	-------------------------	-----------------	----------------

## smartDATA

## CAD data

3D Download 788-384	URL	Téléchargement
---------------------	-----	----------------

Sous réserve de modifications.