

# Fiche technique | Numéro d'article: 788-506

Module relais; Tension nominale d'entrée AC 24 V; 1 RT; Limitation courant constant 16 A; Indication d'état rouge; Largeur 15 mm

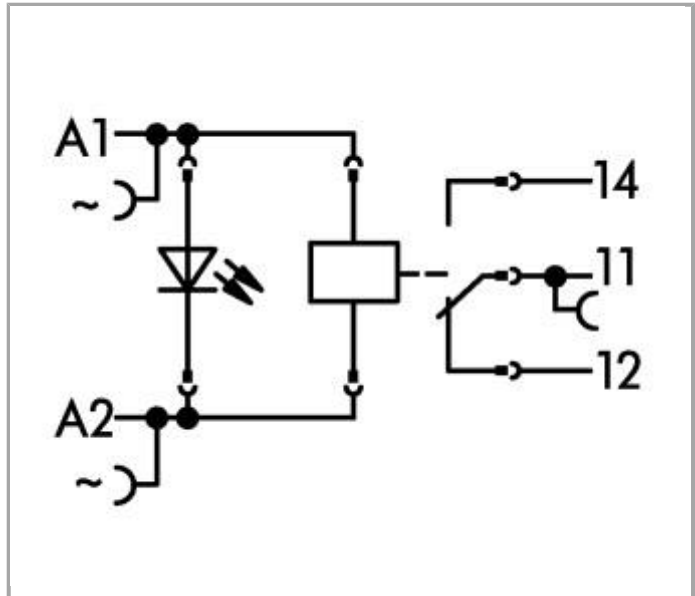

[www.wago.com/788-506](http://www.wago.com/788-506)

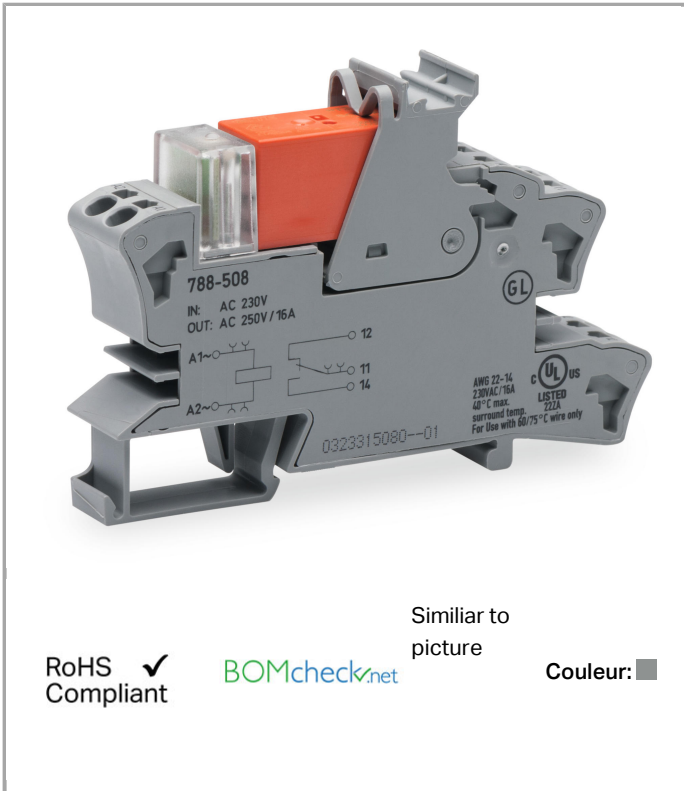

Similar to picture

RoHS  Compliant

[BOMcheck.net](http://BOMcheck.net)

Couleur: ■

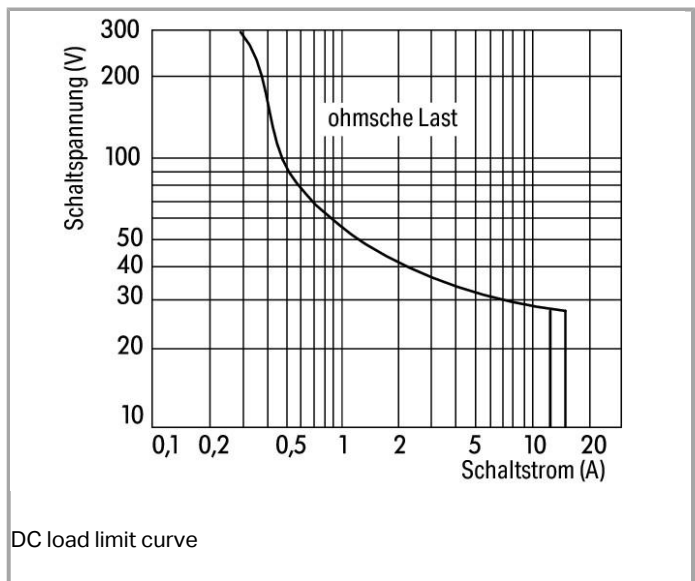
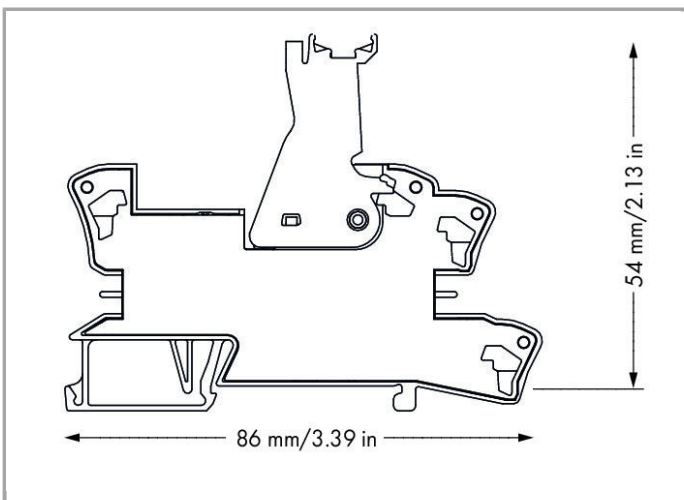

DC load limit curve

## Description du produit :

Note:

## Remarques :

- Isolation renforcée entre bobine et contacts
- Pour des tensions supérieures à 250 V entre modules relais connectés et pour respecter l'isolation renforcée, il faut utiliser un séparateur (par ex. 209-191).
- Un dispositif d'antiparasitage approprié doit être installé parallèlement aux charges inductives.

## Données

## Données techniques

## Circuit de commande

Nominal input voltage $U_N$	24 VAC
Input voltage range	$\pm 10\%$
Courant d'entrée nominal IN	34 mA

## Circuit de charge

Nombre relais 1 T/contacts inverseurs	1
Contact material (relay)	AgNi 90/10
Limiting continuous current	16 A
Max. make current (resistive)	4 s 30 A (AC)
Max. switching voltage	250 VAC
Max. switching power (resistive)	4000 VAAC; DC see load limit curve
Switching capacity	AC-15: 6 A / 250 VAC; DC-13: 2 A / 24 VDC
Charge min. recommandée	12 V / 10 mA
Temps de montée typ.	8 ms
Temps de relâchement	6 ms
Temps de rebondissement (typ.)	6 ms
Electrical life (N.O.; resistive load; 23 °C)	$30 \times 10^3$ switching operations
Mechanical life (N.O.; resistive load; 23 °C)	$30 \times 10^6$ switching operations
Max. switching load with load/without load	$6 \text{ min}^{-1} / 1200 \text{ min}^{-1}$

## Signaling

Indication d'état	LED red
-------------------	---------

## Sécurité &amp; Protection

Tension de référence	250 V
Tension assignée de tenue aux chocs	4 kV
Degré de pollution	3
Tension de claquage contact-bobine (AC, 1 min.)	$5 \text{ kV}_{\text{rms}}$

Dielectric strength, control/load circuit (AC, 1 min)	5 kV <sub>rms</sub>
Tension de claquage contact ouvert (AC, 1 min)	1 kV <sub>rms</sub>
Dielectric strength open contact (AC, 1 min)	1 kV <sub>rms</sub>
Indice de protection	IP20

### Données de raccordement

Technique de connexion	Push-in CAGE CLAMP®
Conducteur rigide	0,34 ... 2,5 mm <sup>2</sup> / 22 ... 14 AWG
Conducteur souple	0,34 ... 2,5 mm <sup>2</sup> / 22 ... 14 AWG
Longueur de dénudage	9 ... 10 mm / 0.35 ... 0.39 inch

### Données géométriques

Largeur	15 mm / 0.591 inch
Profondeur à partir du niveau supérieur du rail	54 mm / 2.126 inch
Profondeur	86 mm / 3.386 inch

### Données mécaniques

Type de montage	Rail 35
-----------------	---------

### Données du matériau

Couleur	gris
Poids	46.378 g

### Conditions d'environnement

Température ambiante admissible Fonctionnement pour U <sub>N</sub>	-25 ... 70 °C
Température ambiante (stockage)	-40 ... 70 °C
Degré de pollution	3

### Normes et spécifications

Normes/spécifications	EN 61010-2-201; EN 61810-1; EN 61373; UL 508
-----------------------	--

### Elementary relay

WAGO elementary relay	788-170
-----------------------	---------



### Dates commerciales

Country of origin	DE
GTIN	4045454424121

Customs Tariff No.	85364900990
Product Group	6 (Interface Electronics)

## Autorisations / certificats

### Approbations de navire

Logo	Approbation	Nom du certificat
	<b>DNV GL</b> Det Norske Veritas, Germanischer Lloyd	TAA00001D1
	<b>NK</b> Nippon Kaiji Kyokai	TA17255M
	<b>PRS</b> Polski Rejestr Statkow	TE/1989/880590/13

### Approbations UL





Logo	Approbation	Nom du certificat
	<b>UL</b> UL International Netherlands B.V. (ORDINARY LOCATIONS)	E175199 Sec.6

## Produits correspondants





### tools

	<b>N° art.: 210-720</b> Outil de manipulation, partiellement isolé; Type 2, lame (3,5 x 0,5) mm	<a href="http://www.wago.com/210-720">www.wago.com/210-720</a>
--	--	--











### Jumper















	<b>N° art.: 788-118</b> Peigne de pontage; 2 pôles (1-3); isolé	<a href="http://www.wago.com/788-118">www.wago.com/788-118</a>
	<b>N° art.: 859-402</b> Peigne de pontage; 2 raccords; Courant nominal 18 A; isolé	<a href="http://www.wago.com/859-402">www.wago.com/859-402</a>
	<b>N° art.: 859-402/000-005</b> Peigne de pontage; 2 raccords; Courant nominal 18 A; isolé	<a href="http://www.wago.com/859-402/000-005">www.wago.com/859-402/000-005</a>
	<b>N° art.: 859-402/000-006</b> Peigne de pontage; 2 raccords; Courant nominal 18 A; isolé	<a href="http://www.wago.com/859-402/000-006">www.wago.com/859-402/000-006</a>
	<b>N° art.: 859-402/000-029</b> Peigne de pontage; 2 raccords; Courant nominal 18 A; isolé	<a href="http://www.wago.com/859-402/000-029">www.wago.com/859-402/000-029</a>















## ferrule















	<b>N° art.: 216-241</b> Embout d'extrémité; embout pour 0,5 mm <sup>2</sup> / AWG 22; avec isolation plastique; étamés par électrolyse; Cuivre électrolytique; serti de manière étanche aux gaz; selon DIN 46228, partie 4/09.90	<a href="http://www.wago.com/216-241">www.wago.com/216-241</a>
	<b>N° art.: 216-242</b> Embout d'extrémité; embout pour 0,75 mm <sup>2</sup> / AWG 20; avec isolation plastique; étamés par électrolyse; Cuivre électrolytique; serti de manière étanche aux gaz; selon DIN 46228, partie 4/09.90	<a href="http://www.wago.com/216-242">www.wago.com/216-242</a>
	<b>N° art.: 216-243</b> Embout d'extrémité; embout pour 1 mm <sup>2</sup> / AWG 18; avec isolation plastique; étamés par électrolyse; Cuivre électrolytique; serti de manière étanche aux gaz; selon DIN 46228, partie 4/09.90	<a href="http://www.wago.com/216-243">www.wago.com/216-243</a>
	<b>N° art.: 216-244</b> Embout d'extrémité; embout pour 1,5 mm <sup>2</sup> / AWG 16; avec isolation plastique; étamés par électrolyse; Cuivre électrolytique; serti de manière étanche aux gaz; selon DIN 46228, partie 4/09.90	<a href="http://www.wago.com/216-244">www.wago.com/216-244</a>
	<b>N° art.: 216-542</b> Embout d'extrémité double; Embout pour 2 x 1 mm <sup>2</sup> / AWG 2 x 18; rouge, isolé; longueur 12 mm	<a href="http://www.wago.com/216-542">www.wago.com/216-542</a>

## Marking accessories

	<b>N° art.: 2009-110</b> Bandes de marquage; sur rouleau; non extensible; vierge; encliquetable	<a href="http://www.wago.com/2009-110">www.wago.com/2009-110</a>
	<b>N° art.: 2009-115</b> WMB-Inline; pour smartPRINTER; sur rouleau; extensible 5 - 5,2 MM; vierge; encliquetable	<a href="http://www.wago.com/2009-115">www.wago.com/2009-115</a>
	<b>N° art.: 2009-115/000-002</b> WMB-Inline; pour smartPRINTER; sur rouleau; extensible 5 - 5,2 MM; vierge; encliquetable	<a href="http://www.wago.com/2009-115/000-002">www.wago.com/2009-115/000-002</a>
	<b>N° art.: 2009-115/000-006</b> WMB-Inline; pour smartPRINTER; sur rouleau; extensible 5 - 5,2 MM; vierge; encliquetable	<a href="http://www.wago.com/2009-115/000-006">www.wago.com/2009-115/000-006</a>
	<b>N° art.: 2009-115/000-007</b> WMB-Inline; sur rouleau; extensible 5 - 5,2 MM; vierge; encliquetable	<a href="http://www.wago.com/2009-115/000-007">www.wago.com/2009-115/000-007</a>
	<b>N° art.: 2009-115/000-012</b> WMB-Inline; pour smartPRINTER; sur rouleau; extensible 5 - 5,2 MM; vierge; encliquetable	<a href="http://www.wago.com/2009-115/000-012">www.wago.com/2009-115/000-012</a>
	<b>N° art.: 2009-115/000-017</b> WMB-Inline; sur rouleau; extensible 5 - 5,2 MM; vierge; encliquetable	<a href="http://www.wago.com/2009-115/000-017">www.wago.com/2009-115/000-017</a>
	<b>N° art.: 2009-115/000-023</b> WMB-Inline; pour smartPRINTER; sur rouleau; extensible 5 - 5,2 MM; vierge; encliquetable	<a href="http://www.wago.com/2009-115/000-023">www.wago.com/2009-115/000-023</a>
	<b>N° art.: 209-128</b> Adaptateur	<a href="http://www.wago.com/209-128">www.wago.com/209-128</a>
	<b>N° art.: 209-183</b> Étiquette à enficher	<a href="http://www.wago.com/209-183">www.wago.com/209-183</a>
	<b>N° art.: 210-110</b> Stylo feutre-graveur	<a href="http://www.wago.com/210-110">www.wago.com/210-110</a>

	<p><b>N° art.: 793-501</b> Carte de repérage WMB; en carte; non extensible; vierge; encliquetable</p>	<a href="http://www.wago.com/793-501">www.wago.com/793-501</a>
	<p><b>N° art.: 793-501/000-002</b> Carte de repérage WMB; en carte; non extensible; vierge; encliquetable</p>	<a href="http://www.wago.com/793-501/000-002">www.wago.com/793-501/000-002</a>
	<p><b>N° art.: 793-501/000-005</b> Carte de repérage WMB; en carte; non extensible; vierge; encliquetable</p>	<a href="http://www.wago.com/793-501/000-005">www.wago.com/793-501/000-005</a>
	<p><b>N° art.: 793-501/000-006</b> Carte de repérage WMB; en carte; non extensible; vierge; encliquetable</p>	<a href="http://www.wago.com/793-501/000-006">www.wago.com/793-501/000-006</a>
	<p><b>N° art.: 793-501/000-007</b> Carte de repérage WMB; en carte; non extensible; vierge; encliquetable</p>	<a href="http://www.wago.com/793-501/000-007">www.wago.com/793-501/000-007</a>
	<p><b>N° art.: 793-501/000-012</b> Carte de repérage WMB; en carte; non extensible; vierge; encliquetable</p>	<a href="http://www.wago.com/793-501/000-012">www.wago.com/793-501/000-012</a>
	<p><b>N° art.: 793-501/000-017</b> Carte de repérage WMB; en carte; non extensible; vierge; encliquetable</p>	<a href="http://www.wago.com/793-501/000-017">www.wago.com/793-501/000-017</a>
	<p><b>N° art.: 793-501/000-023</b> Carte de repérage WMB; en carte; non extensible; vierge; encliquetable</p>	<a href="http://www.wago.com/793-501/000-023">www.wago.com/793-501/000-023</a>
	<p><b>N° art.: 793-501/000-024</b> Carte de repérage WMB; en carte; non extensible; vierge; encliquetable</p>	<a href="http://www.wago.com/793-501/000-024">www.wago.com/793-501/000-024</a>
	<p><b>N° art.: 793-502</b> Carte de repérage WMB; en carte; avec impression; 1 ... 10 (10x); non extensible; Impression horizontale; encliquetable</p>	<a href="http://www.wago.com/793-502">www.wago.com/793-502</a>
	<p><b>N° art.: 793-502/000-002</b> Carte de repérage WMB; en carte; avec impression; 1 ... 10 (10x); non extensible; Impression horizontale; encliquetable</p>	<a href="http://www.wago.com/793-502/000-002">www.wago.com/793-502/000-002</a>
	<p><b>N° art.: 793-502/000-005</b> Carte de repérage WMB; en carte; avec impression; 1 ... 10 (10x); non extensible; Impression horizontale; encliquetable</p>	<a href="http://www.wago.com/793-502/000-005">www.wago.com/793-502/000-005</a>
	<p><b>N° art.: 793-502/000-006</b> Carte de repérage WMB; en carte; avec impression; 1 ... 10 (10x); non extensible; Impression horizontale; encliquetable</p>	<a href="http://www.wago.com/793-502/000-006">www.wago.com/793-502/000-006</a>
	<p><b>N° art.: 793-502/000-007</b> Carte de repérage WMB; en carte; avec impression; 1 ... 10 (10x); non extensible; Impression horizontale; encliquetable</p>	<a href="http://www.wago.com/793-502/000-007">www.wago.com/793-502/000-007</a>
	<p><b>N° art.: 793-502/000-012</b> Carte de repérage WMB; en carte; avec impression; 1 ... 10 (10x); non extensible; Impression horizontale; encliquetable</p>	<a href="http://www.wago.com/793-502/000-012">www.wago.com/793-502/000-012</a>

	<p><b>N° art.: 793-502/000-017</b>                      Carte de repérage WMB; en carte; avec impression; 1 ... 10 (10x); non extensible; Impression horizontale; encliquetable</p>	<p><a href="http://www.wago.com/793-502/000-017">www.wago.com/793-502/000-017</a></p>
	<p><b>N° art.: 793-502/000-023</b>                      Carte de repérage WMB; en carte; avec impression; 1 ... 10 (10x); non extensible; Impression horizontale; encliquetable</p>	<p><a href="http://www.wago.com/793-502/000-023">www.wago.com/793-502/000-023</a></p>
	<p><b>N° art.: 793-502/000-024</b>                      Carte de repérage WMB; en carte; avec impression; 1 ... 10 (10x); non extensible; Impression horizontale; encliquetable</p>	<p><a href="http://www.wago.com/793-502/000-024">www.wago.com/793-502/000-024</a></p>
	<p><b>N° art.: 793-503</b>                      Carte de repérage WMB; en carte; avec impression; 11 ... 20 (10x); non extensible; Impression horizontale; encliquetable</p>	<p><a href="http://www.wago.com/793-503">www.wago.com/793-503</a></p>
	<p><b>N° art.: 793-503/000-002</b>                      Carte de repérage WMB; en carte; avec impression; 11 ... 20 (10x); non extensible; Impression horizontale; encliquetable</p>	<p><a href="http://www.wago.com/793-503/000-002">www.wago.com/793-503/000-002</a></p>
	<p><b>N° art.: 793-503/000-005</b>                      Carte de repérage WMB; en carte; avec impression; 11 ... 20 (10x); non extensible; Impression horizontale; encliquetable</p>	<p><a href="http://www.wago.com/793-503/000-005">www.wago.com/793-503/000-005</a></p>
	<p><b>N° art.: 793-503/000-006</b>                      Carte de repérage WMB; en carte; avec impression; 11 ... 20 (10x); non extensible; Impression horizontale; encliquetable</p>	<p><a href="http://www.wago.com/793-503/000-006">www.wago.com/793-503/000-006</a></p>
	<p><b>N° art.: 793-503/000-007</b>                      Carte de repérage WMB; en carte; avec impression; 11 ... 20 (10x); non extensible; Impression horizontale; encliquetable</p>	<p><a href="http://www.wago.com/793-503/000-007">www.wago.com/793-503/000-007</a></p>
	<p><b>N° art.: 793-503/000-012</b>                      Carte de repérage WMB; en carte; avec impression; 11 ... 20 (10x); non extensible; Impression horizontale; encliquetable</p>	<p><a href="http://www.wago.com/793-503/000-012">www.wago.com/793-503/000-012</a></p>
	<p><b>N° art.: 793-503/000-017</b>                      Carte de repérage WMB; en carte; avec impression; 11 ... 20 (10x); non extensible; Impression horizontale; encliquetable</p>	<p><a href="http://www.wago.com/793-503/000-017">www.wago.com/793-503/000-017</a></p>
	<p><b>N° art.: 793-503/000-023</b>                      Carte de repérage WMB; en carte; avec impression; 11 ... 20 (10x); non extensible; Impression horizontale; encliquetable</p>	<p><a href="http://www.wago.com/793-503/000-023">www.wago.com/793-503/000-023</a></p>
	<p><b>N° art.: 793-503/000-024</b>                      Carte de repérage WMB; en carte; avec impression; 11 ... 20 (10x); non extensible; Impression horizontale; encliquetable</p>	<p><a href="http://www.wago.com/793-503/000-024">www.wago.com/793-503/000-024</a></p>
	<p><b>N° art.: 793-504</b>                      Carte de repérage WMB; en carte; avec impression; 21 ... 30 (10x); non extensible; Impression horizontale; encliquetable</p>	<p><a href="http://www.wago.com/793-504">www.wago.com/793-504</a></p>
	<p><b>N° art.: 793-504/000-002</b>                      Carte de repérage WMB; en carte; avec impression; 21 ... 30 (10x); non extensible; Impression horizontale; encliquetable</p>	<p><a href="http://www.wago.com/793-504/000-002">www.wago.com/793-504/000-002</a></p>
	<p><b>N° art.: 793-504/000-005</b>                      Carte de repérage WMB; en carte; avec impression; 21 ... 30 (10x); non extensible; Impression horizontale; encliquetable</p>	<p><a href="http://www.wago.com/793-504/000-005">www.wago.com/793-504/000-005</a></p>

	<p><b>N° art.: 793-504/000-006</b>                      Carte de repérage WMB; en carte; avec impression; 21 ... 30 (10x); non extensible; Impression horizontale; encliquetable</p>	<a href="http://www.wago.com/793-504/000-006">www.wago.com/793-504/000-006</a>
	<p><b>N° art.: 793-504/000-012</b>                      Carte de repérage WMB; en carte; avec impression; 21 ... 30 (10x); non extensible; Impression horizontale; encliquetable</p>	<a href="http://www.wago.com/793-504/000-012">www.wago.com/793-504/000-012</a>
	<p><b>N° art.: 793-504/000-017</b>                      Carte de repérage WMB; en carte; avec impression; 21 ... 30 (10x); non extensible; Impression horizontale; encliquetable</p>	<a href="http://www.wago.com/793-504/000-017">www.wago.com/793-504/000-017</a>
	<p><b>N° art.: 793-504/000-023</b>                      Carte de repérage WMB; en carte; avec impression; 21 ... 30 (10x); non extensible; Impression horizontale; encliquetable</p>	<a href="http://www.wago.com/793-504/000-023">www.wago.com/793-504/000-023</a>
	<p><b>N° art.: 793-505</b>                      Carte de repérage WMB; en carte; avec impression; 31 ... 40 (10x); non extensible; Impression horizontale; encliquetable</p>	<a href="http://www.wago.com/793-505">www.wago.com/793-505</a>
	<p><b>N° art.: 793-505/000-005</b>                      Carte de repérage WMB; en carte; avec impression; 31 ... 40 (10x); non extensible; Impression horizontale; encliquetable</p>	<a href="http://www.wago.com/793-505/000-005">www.wago.com/793-505/000-005</a>
	<p><b>N° art.: 793-505/000-006</b>                      Carte de repérage WMB; en carte; avec impression; 31 ... 40 (10x); non extensible; Impression horizontale; encliquetable</p>	<a href="http://www.wago.com/793-505/000-006">www.wago.com/793-505/000-006</a>
	<p><b>N° art.: 793-505/000-007</b>                      Carte de repérage WMB; en carte; avec impression; 31 ... 40 (10x); non extensible; Impression horizontale; encliquetable</p>	<a href="http://www.wago.com/793-505/000-007">www.wago.com/793-505/000-007</a>
	<p><b>N° art.: 793-505/000-012</b>                      Carte de repérage WMB; en carte; avec impression; 31 ... 40 (10x); non extensible; Impression horizontale; encliquetable</p>	<a href="http://www.wago.com/793-505/000-012">www.wago.com/793-505/000-012</a>
	<p><b>N° art.: 793-506</b>                      Carte de repérage WMB; en carte; avec impression; 41 ... 50 (10x); non extensible; Impression horizontale; encliquetable</p>	<a href="http://www.wago.com/793-506">www.wago.com/793-506</a>
	<p><b>N° art.: 793-506/000-005</b>                      Carte de repérage WMB; en carte; avec impression; 41 ... 50 (10x); non extensible; Impression horizontale; encliquetable</p>	<a href="http://www.wago.com/793-506/000-005">www.wago.com/793-506/000-005</a>
	<p><b>N° art.: 793-506/000-006</b>                      Carte de repérage WMB; en carte; avec impression; 41 ... 50 (10x); non extensible; Impression horizontale; encliquetable</p>	<a href="http://www.wago.com/793-506/000-006">www.wago.com/793-506/000-006</a>
	<p><b>N° art.: 793-506/000-012</b>                      Carte de repérage WMB; en carte; avec impression; 41 ... 50 (10x); non extensible; Impression horizontale; encliquetable</p>	<a href="http://www.wago.com/793-506/000-012">www.wago.com/793-506/000-012</a>
	<p><b>N° art.: 793-506/000-017</b>                      Carte de repérage WMB; en carte; avec impression; 41 ... 50 (10x); non extensible; Impression horizontale; encliquetable</p>	<a href="http://www.wago.com/793-506/000-017">www.wago.com/793-506/000-017</a>
	<p><b>N° art.: 793-5501</b>                      Carte de repérage WMB; en carte; largeur des bornes 5 - 17,5 mm; extensible 5 - 5,2 MM; vierge; encliquetable</p>	<a href="http://www.wago.com/793-5501">www.wago.com/793-5501</a>





**N° art.: 793-5501/000-002**

Carte de repérage WMB; en carte; largeur des bornes 5 - 17,5 mm; extensible 5 - 5,2 MM; vierge; encliquetable

[www.wago.com/793-5501/000-002](http://www.wago.com/793-5501/000-002)



**N° art.: 793-5501/000-005**

Carte de repérage WMB; en carte; extensible 5 - 5,2 MM; vierge; encliquetable

[www.wago.com/793-5501/000-005](http://www.wago.com/793-5501/000-005)



**N° art.: 793-5501/000-006**

Carte de repérage WMB; en carte; extensible 5 - 5,2 MM; vierge; encliquetable

[www.wago.com/793-5501/000-006](http://www.wago.com/793-5501/000-006)



**N° art.: 793-5501/000-007**

Carte de repérage WMB; en carte; extensible 5 - 5,2 MM; vierge; encliquetable

[www.wago.com/793-5501/000-007](http://www.wago.com/793-5501/000-007)



**N° art.: 793-5501/000-012**

Carte de repérage WMB; en carte; extensible 5 - 5,2 MM; vierge; encliquetable

[www.wago.com/793-5501/000-012](http://www.wago.com/793-5501/000-012)



**N° art.: 793-5501/000-014**

Carte de repérage WMB; en carte; extensible 5 - 5,2 MM; vierge; encliquetable

[www.wago.com/793-5501/000-014](http://www.wago.com/793-5501/000-014)



**N° art.: 793-5501/000-017**

Carte de repérage WMB; en carte; extensible 5 - 5,2 MM; vierge; encliquetable

[www.wago.com/793-5501/000-017](http://www.wago.com/793-5501/000-017)



**N° art.: 793-5501/000-023**

Carte de repérage WMB; en carte; extensible 5 - 5,2 MM; vierge; encliquetable

[www.wago.com/793-5501/000-023](http://www.wago.com/793-5501/000-023)



**N° art.: 793-5501/000-024**

Carte de repérage WMB; en carte; extensible 5 - 5,2 MM; vierge; encliquetable

[www.wago.com/793-5501/000-024](http://www.wago.com/793-5501/000-024)



**N° art.: 793-566**

Carte de repérage WMB; en carte; avec impression; 1 ... 50 (2x); non extensible; Impression horizontale; encliquetable

[www.wago.com/793-566](http://www.wago.com/793-566)



**N° art.: 793-566/000-002**

Carte de repérage WMB; en carte; avec impression; 1 ... 50 (2x); non extensible; Impression horizontale; encliquetable

[www.wago.com/793-566/000-002](http://www.wago.com/793-566/000-002)



**N° art.: 793-566/000-005**

Carte de repérage WMB; en carte; avec impression; 1 ... 50 (2x); non extensible; Impression horizontale; encliquetable

[www.wago.com/793-566/000-005](http://www.wago.com/793-566/000-005)



**N° art.: 793-566/000-006**

Carte de repérage WMB; en carte; avec impression; 1 ... 50 (2x); non extensible; Impression horizontale; encliquetable

[www.wago.com/793-566/000-006](http://www.wago.com/793-566/000-006)



**N° art.: 793-566/000-007**

Carte de repérage WMB; en carte; avec impression; 1 ... 50 (2x); non extensible; Impression horizontale; encliquetable

[www.wago.com/793-566/000-007](http://www.wago.com/793-566/000-007)



**N° art.: 793-566/000-012**

Carte de repérage WMB; en carte; avec impression; 1 ... 50 (2x); non extensible; Impression horizontale; encliquetable

[www.wago.com/793-566/000-012](http://www.wago.com/793-566/000-012)



N° art.: 793-566/000-017

Carte de repérage WMB; en carte; avec impression; 1 ... 50 (2x); non extensible; Impression horizontale; encliquetable

[www.wago.com/793-566/000-017](http://www.wago.com/793-566/000-017)



N° art.: 793-566/000-023

Carte de repérage WMB; en carte; avec impression; 1 ... 50 (2x); non extensible; Impression horizontale; encliquetable

[www.wago.com/793-566/000-023](http://www.wago.com/793-566/000-023)



N° art.: 793-566/000-024

Carte de repérage WMB; en carte; avec impression; 1 ... 50 (2x); non extensible; Impression horizontale; encliquetable

[www.wago.com/793-566/000-024](http://www.wago.com/793-566/000-024)

### General accessories



N° art.: 209-145

Porte-étiquettes de groupe

[www.wago.com/209-145](http://www.wago.com/209-145)



N° art.: 209-184

Protège-étiquettes

[www.wago.com/209-184](http://www.wago.com/209-184)



N° art.: 249-105

Porte-étiquettes de groupe

[www.wago.com/249-105](http://www.wago.com/249-105)



N° art.: 788-123

Accessoire pour module relais; Etat de fonctionnement rouge

[www.wago.com/788-123](http://www.wago.com/788-123)



N° art.: 788-148

Module de filtrage; élément de filtre RC; Tension nominale AC 230 V

[www.wago.com/788-148](http://www.wago.com/788-148)



N° art.: 788-170

Relais de couplage; Tension nominale d'entrée AC 24 V; 1 RT; Limitation courant constant 16 A; Largeur 13 mm; Hauteur du relais 15 mm

[www.wago.com/788-170](http://www.wago.com/788-170)

### Téléchargements

#### Documentation

##### Bid Text

788-506 Relaisbaustein	Jan 15, 2016	DOC 28,2 kB	Téléchargement
---------------------------	--------------	----------------	----------------

##### Instruction Leaflet

Socket with Relay or SSR	Sep 28, 2015	PDF 2,1 MB	Téléchargement
--------------------------	--------------	---------------	----------------

##### Additional Information

Disposal; Electrical and electronic equipment, Packaging	V 1.0.0 Oct 15, 2018	PDF 269,1 kB	Téléchargement
--	-------------------------	-----------------	----------------



## smartDATA

### CAD data

3D Download 788-506

URL

Téléchargement

---

Sous réserve de modifications.