

Fiche technique | Numéro d'article: 788-512

Module relais; Tension nominale d'entrée AC 24 V; 2 RT; Limitation courant constant 8 A; Indication d'état rouge; Largeur 15 mm

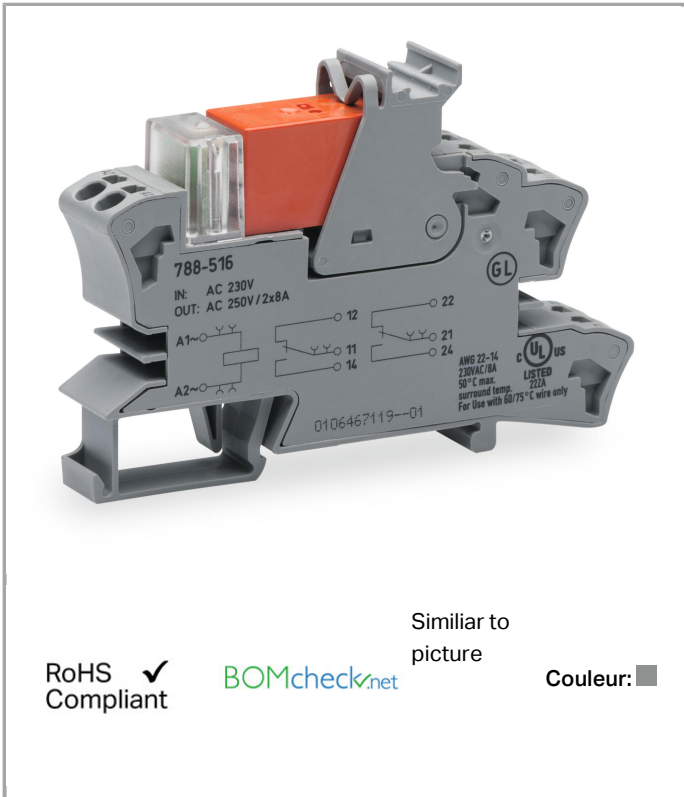

www.wago.com/788-512



Similar to picture

RoHS Compliant

BOMcheck.net

Couleur: ■

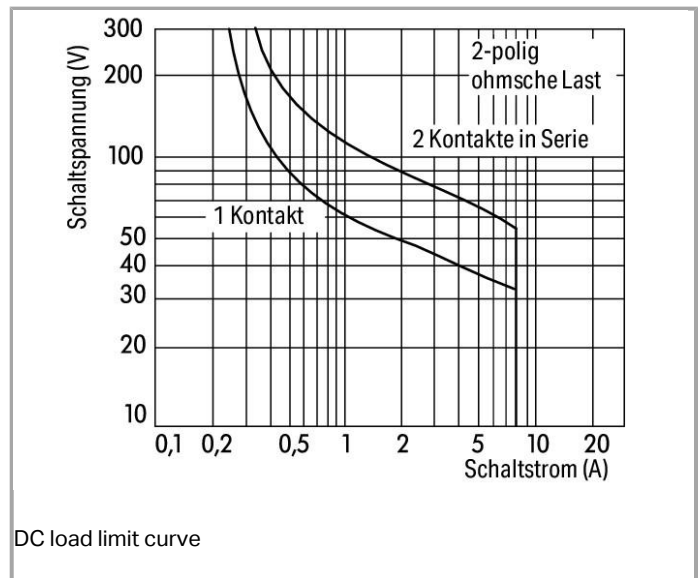
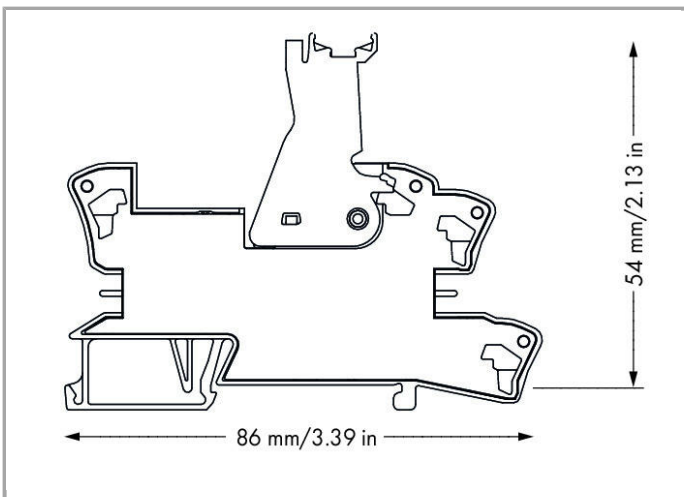
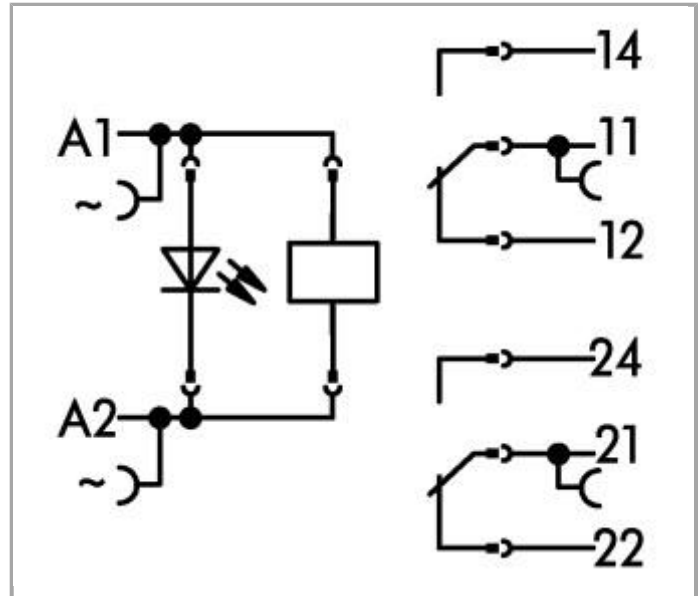

DC load limit curve

Description du produit :

Note:

Remarques :

- Isolation renforcée entre bobine et contacts
- Pour des tensions supérieures à 250 V entre modules relais connectés et pour respecter l'isolation renforcée, il faut utiliser un séparateur (par ex. 209-191).
- Un dispositif d'antiparasitage approprié doit être installé parallèlement aux charges inductives.

Données

Données techniques

Circuit de commande

Nominal input voltage U_N	24 VAC
Input voltage range	$\pm 10\%$
Courant d'entrée nominal IN	34 mA

Circuit de charge

Nombre relais 1 T/contacts inverseurs	2
Contact material (relay)	AgNi 90/10
Limiting continuous current	8 A
Max. make current (resistive)	4 s 15 A (AC)
Max. switching voltage	250 VAC
Max. switching power (resistive)	2000 VAAC; DC see load limit curve
Switching capacity	AC-15: 3 A / 250 VAC; DC-13: 2 A / 24 VDC
Charge min. recommandée	12 V / 10 mA
Temps de montée typ.	8 ms
Temps de relâchement	6 ms
Temps de rebondissement (typ.)	10 ms
Electrical life (N.O.; resistive load; 23 °C)	1×10^3 switching operations
Mechanical life (N.O.; resistive load; 23 °C)	30×10^6 switching operations
Max. switching load with load/without load	$6 \text{ min}^{-1} / 1200 \text{ min}^{-1}$

Signaling

Indication d'état	LED red
-------------------	---------

Sécurité & Protection

Tension de référence	250 V
Tension assignée de tenue aux chocs	4 kV
Degré de pollution	3
Tension de claquage contact-bobine (AC, 1 min.)	$5 \text{ kV}_{\text{rms}}$

Dielectric strength, control/load circuit (AC, 1 min)	5 kV _{rms}
Tension de claquage contact ouvert (AC, 1 min)	1 kV _{rms}
Dielectric strength open contact (AC, 1 min)	1 kV _{rms}
Tension de claquage, contact adjacent (AC, 1 min)	2.5 kV _{rms}
Dielectric strength, load/load circuit (AC, 1 min)	2,5 kV _{rms}
Indice de protection	IP20

Données de raccordement

Technique de connexion	Push-in CAGE CLAMP®
Conducteur rigide	0,34 ... 2,5 mm ² / 22 ... 14 AWG
Conducteur souple	0,34 ... 2,5 mm ² / 22 ... 14 AWG
Longueur de dénudage	9 ... 10 mm / 0.35 ... 0.39 inch

Données géométriques

Largeur	15 mm / 0.591 inch
Profondeur à partir du niveau supérieur du rail	54 mm / 2.126 inch
Profondeur	86 mm / 3.386 inch

Données mécaniques

Type de montage	Rail 35
-----------------	---------

Données du matériau

Couleur	gris
Charge calorifique	0.89 MJ
Poids	47.662 g

Conditions d'environnement

Température ambiante admissible Fonctionnement pour U _N	-25 ... 70 °C
Température ambiante (stockage)	-40 ... 70 °C
Degré de pollution	3

Normes et spécifications

Normes/spécifications	EN 61010-2-201; EN 61810-1; EN 61373; GL; UL 508
-----------------------	--

Elementary relay



WAGO elementary relay	788-172
-----------------------	---------

Dates commerciales

Country of origin	CN
GTIN	4045454424145
Customs Tariff No.	85364900990
Product Group	6 (Interface Electronics)

Autorisations / certificats

Approbations de navire

Logo	Approbation	Nom du certificat
	DNV GL Det Norske Veritas, Germanischer Lloyd	TAA00001D1
	NK Nippon Kaiji Kyokai	TA17255M
	PRS Polski Rejestr Statkow	TE/1989/880590/13

Approbations UL





Logo	Approbation	Nom du certificat
	UL UL International Netherlands B.V. (ORDINARY LOCATIONS)	E175199 Sec.6

Produits correspondants

tools

	N° art.: 210-720 Outil de manipulation, partiellement isolé; Type 2, lame (3,5 x 0,5) mm	www.wago.com/210-720
--	--	--

ferrule

	N° art.: 216-241 Embout d'extrémité; embout pour 0,5 mm ² / AWG 22; avec isolation plastique; étamés par électrolyse; Cuivre électrolytique; serti de manière étanche aux gaz; selon DIN 46228, partie 4/09.90	www.wago.com/216-241
	N° art.: 216-242 Embout d'extrémité; embout pour 0,75 mm ² / AWG 20; avec isolation plastique; étamés par électrolyse; Cuivre électrolytique; serti de manière étanche aux gaz; selon DIN 46228, partie 4/09.90	www.wago.com/216-242
	N° art.: 216-243 Embout d'extrémité; embout pour 1 mm ² / AWG 18; avec isolation plastique; étamés par électrolyse; Cuivre électrolytique; serti de manière étanche aux gaz; selon DIN 46228, partie 4/09.90	www.wago.com/216-243
	N° art.: 216-244 Embout d'extrémité; embout pour 1,5 mm ² / AWG 16; avec isolation plastique; étamés par électrolyse; Cuivre électrolytique; serti de manière étanche aux gaz; selon DIN 46228, partie 4/09.90	www.wago.com/216-244



N° art.: 216-542

Embout d'extrémité double; Embout pour 2 x 1 mm² / AWG 2 x 18; rouge, isolé; longueur 12 mmwww.wago.com/216-542

Jumper



N° art.: 788-118

Peigne de pontage; 2 pôles (1-3); isolé

www.wago.com/788-118

N° art.: 859-402

Peigne de pontage; 2 raccords; Courant nominal 18 A; isolé

www.wago.com/859-402

N° art.: 859-402/000-005

Peigne de pontage; 2 raccords; Courant nominal 18 A; isolé

www.wago.com/859-402/000-005

N° art.: 859-402/000-006

Peigne de pontage; 2 raccords; Courant nominal 18 A; isolé

www.wago.com/859-402/000-006

N° art.: 859-402/000-029

Peigne de pontage; 2 raccords; Courant nominal 18 A; isolé

www.wago.com/859-402/000-029

General accessories



N° art.: 209-145

Porte-étiquettes de groupe

www.wago.com/209-145

N° art.: 209-184

Protège-étiquettes

www.wago.com/209-184

N° art.: 249-105

Porte-étiquettes de groupe

www.wago.com/249-105

N° art.: 788-123

Accessoire pour module relais; Etat de fonctionnement rouge

www.wago.com/788-123

N° art.: 788-148

Module de filtrage; élément de filtre RC; Tension nominale AC 230 V

www.wago.com/788-148

Marking accessories



N° art.: 2009-110

Bandes de marquage; sur rouleau; non extensible; vierge; encliquetable

www.wago.com/2009-110

N° art.: 2009-115

WMB-Inline; pour smartPRINTER; sur rouleau; extensible 5 - 5,2 MM; vierge; encliquetable

www.wago.com/2009-115

N° art.: 2009-115/000-002

WMB-Inline; pour smartPRINTER; sur rouleau; extensible 5 - 5,2 MM; vierge; encliquetable

www.wago.com/2009-115/000-002

N° art.: 2009-115/000-006

WMB-Inline; pour smartPRINTER; sur rouleau; extensible 5 - 5,2 MM; vierge; encliquetable

www.wago.com/2009-115/000-006

N° art.: 2009-115/000-007

WMB-Inline; sur rouleau; extensible 5 - 5,2 MM; vierge; encliquetable

www.wago.com/2009-115/000-007



N° art.: 2009-115/000-012
WMB-Inline; pour smartPRINTER; sur rouleau; extensible 5 - 5,2 MM; vierge; encliquetable

www.wago.com/2009-115/000-012



N° art.: 2009-115/000-017
WMB-Inline; sur rouleau; extensible 5 - 5,2 MM; vierge; encliquetable

www.wago.com/2009-115/000-017



N° art.: 2009-115/000-023
WMB-Inline; pour smartPRINTER; sur rouleau; extensible 5 - 5,2 MM; vierge; encliquetable

www.wago.com/2009-115/000-023



N° art.: 209-128
Adaptateur

www.wago.com/209-128



N° art.: 209-183
Étiquette à enficher

www.wago.com/209-183



N° art.: 210-110
Stylo feutre-graveur

www.wago.com/210-110



N° art.: 793-501
Carte de repérage WMB; en carte; non extensible; vierge; encliquetable

www.wago.com/793-501



N° art.: 793-501/000-002
Carte de repérage WMB; en carte; non extensible; vierge; encliquetable

www.wago.com/793-501/000-002



N° art.: 793-501/000-005
Carte de repérage WMB; en carte; non extensible; vierge; encliquetable

www.wago.com/793-501/000-005



N° art.: 793-501/000-006
Carte de repérage WMB; en carte; non extensible; vierge; encliquetable

www.wago.com/793-501/000-006



N° art.: 793-501/000-007
Carte de repérage WMB; en carte; non extensible; vierge; encliquetable

www.wago.com/793-501/000-007



N° art.: 793-501/000-012
Carte de repérage WMB; en carte; non extensible; vierge; encliquetable

www.wago.com/793-501/000-012



N° art.: 793-501/000-017
Carte de repérage WMB; en carte; non extensible; vierge; encliquetable

www.wago.com/793-501/000-017

















N° art.: 793-501/000-023
Carte de repérage WMB; en carte; non extensible; vierge; encliquetable















www.wago.com/793-501/000-023

















N° art.: 793-501/000-024
Carte de repérage WMB; en carte; non extensible; vierge; encliquetable

www.wago.com/793-501/000-024

	<p>N° art.: 793-502 Carte de repérage WMB; en carte; avec impression; 1 ... 10 (10x); non extensible; Impression horizontale; encliquetable</p>	www.wago.com/793-502
	<p>N° art.: 793-502/000-002 Carte de repérage WMB; en carte; avec impression; 1 ... 10 (10x); non extensible; Impression horizontale; encliquetable</p>	www.wago.com/793-502/000-002
	<p>N° art.: 793-502/000-005 Carte de repérage WMB; en carte; avec impression; 1 ... 10 (10x); non extensible; Impression horizontale; encliquetable</p>	www.wago.com/793-502/000-005
	<p>N° art.: 793-502/000-006 Carte de repérage WMB; en carte; avec impression; 1 ... 10 (10x); non extensible; Impression horizontale; encliquetable</p>	www.wago.com/793-502/000-006
	<p>N° art.: 793-502/000-007 Carte de repérage WMB; en carte; avec impression; 1 ... 10 (10x); non extensible; Impression horizontale; encliquetable</p>	www.wago.com/793-502/000-007
	<p>N° art.: 793-502/000-012 Carte de repérage WMB; en carte; avec impression; 1 ... 10 (10x); non extensible; Impression horizontale; encliquetable</p>	www.wago.com/793-502/000-012
	<p>N° art.: 793-502/000-017 Carte de repérage WMB; en carte; avec impression; 1 ... 10 (10x); non extensible; Impression horizontale; encliquetable</p>	www.wago.com/793-502/000-017
	<p>N° art.: 793-502/000-023 Carte de repérage WMB; en carte; avec impression; 1 ... 10 (10x); non extensible; Impression horizontale; encliquetable</p>	www.wago.com/793-502/000-023
	<p>N° art.: 793-502/000-024 Carte de repérage WMB; en carte; avec impression; 1 ... 10 (10x); non extensible; Impression horizontale; encliquetable</p>	www.wago.com/793-502/000-024
	<p>N° art.: 793-503 Carte de repérage WMB; en carte; avec impression; 11 ... 20 (10x); non extensible; Impression horizontale; encliquetable</p>	www.wago.com/793-503
	<p>N° art.: 793-503/000-002 Carte de repérage WMB; en carte; avec impression; 11 ... 20 (10x); non extensible; Impression horizontale; encliquetable</p>	www.wago.com/793-503/000-002
	<p>N° art.: 793-503/000-005 Carte de repérage WMB; en carte; avec impression; 11 ... 20 (10x); non extensible; Impression horizontale; encliquetable</p>	www.wago.com/793-503/000-005
	<p>N° art.: 793-503/000-006 Carte de repérage WMB; en carte; avec impression; 11 ... 20 (10x); non extensible; Impression horizontale; encliquetable</p>	www.wago.com/793-503/000-006
	<p>N° art.: 793-503/000-007 Carte de repérage WMB; en carte; avec impression; 11 ... 20 (10x); non extensible; Impression horizontale; encliquetable</p>	www.wago.com/793-503/000-007
	<p>N° art.: 793-503/000-012 Carte de repérage WMB; en carte; avec impression; 11 ... 20 (10x); non extensible; Impression horizontale; encliquetable</p>	www.wago.com/793-503/000-012

	<p>N° art.: 793-503/000-017 Carte de repérage WMB; en carte; avec impression; 11 ... 20 (10x); non extensible; Impression horizontale; encliquetable</p>	<p>www.wago.com/793-503/000-017</p>
	<p>N° art.: 793-503/000-023 Carte de repérage WMB; en carte; avec impression; 11 ... 20 (10x); non extensible; Impression horizontale; encliquetable</p>	<p>www.wago.com/793-503/000-023</p>
	<p>N° art.: 793-503/000-024 Carte de repérage WMB; en carte; avec impression; 11 ... 20 (10x); non extensible; Impression horizontale; encliquetable</p>	<p>www.wago.com/793-503/000-024</p>
	<p>N° art.: 793-504 Carte de repérage WMB; en carte; avec impression; 21 ... 30 (10x); non extensible; Impression horizontale; encliquetable</p>	<p>www.wago.com/793-504</p>
	<p>N° art.: 793-504/000-002 Carte de repérage WMB; en carte; avec impression; 21 ... 30 (10x); non extensible; Impression horizontale; encliquetable</p>	<p>www.wago.com/793-504/000-002</p>
	<p>N° art.: 793-504/000-005 Carte de repérage WMB; en carte; avec impression; 21 ... 30 (10x); non extensible; Impression horizontale; encliquetable</p>	<p>www.wago.com/793-504/000-005</p>
	<p>N° art.: 793-504/000-006 Carte de repérage WMB; en carte; avec impression; 21 ... 30 (10x); non extensible; Impression horizontale; encliquetable</p>	<p>www.wago.com/793-504/000-006</p>
	<p>N° art.: 793-504/000-012 Carte de repérage WMB; en carte; avec impression; 21 ... 30 (10x); non extensible; Impression horizontale; encliquetable</p>	<p>www.wago.com/793-504/000-012</p>
	<p>N° art.: 793-504/000-017 Carte de repérage WMB; en carte; avec impression; 21 ... 30 (10x); non extensible; Impression horizontale; encliquetable</p>	<p>www.wago.com/793-504/000-017</p>
	<p>N° art.: 793-504/000-023 Carte de repérage WMB; en carte; avec impression; 21 ... 30 (10x); non extensible; Impression horizontale; encliquetable</p>	<p>www.wago.com/793-504/000-023</p>
	<p>N° art.: 793-505 Carte de repérage WMB; en carte; avec impression; 31 ... 40 (10x); non extensible; Impression horizontale; encliquetable</p>	<p>www.wago.com/793-505</p>
	<p>N° art.: 793-505/000-005 Carte de repérage WMB; en carte; avec impression; 31 ... 40 (10x); non extensible; Impression horizontale; encliquetable</p>	<p>www.wago.com/793-505/000-005</p>
	<p>N° art.: 793-505/000-006 Carte de repérage WMB; en carte; avec impression; 31 ... 40 (10x); non extensible; Impression horizontale; encliquetable</p>	<p>www.wago.com/793-505/000-006</p>
	<p>N° art.: 793-505/000-007 Carte de repérage WMB; en carte; avec impression; 31 ... 40 (10x); non extensible; Impression horizontale; encliquetable</p>	<p>www.wago.com/793-505/000-007</p>
	<p>N° art.: 793-505/000-012 Carte de repérage WMB; en carte; avec impression; 31 ... 40 (10x); non extensible; Impression horizontale; encliquetable</p>	<p>www.wago.com/793-505/000-012</p>

	<p>N° art.: 793-506 Carte de repérage WMB; en carte; avec impression; 41 ... 50 (10x); non extensible; Impression horizontale; encliquetable</p>	www.wago.com/793-506
	<p>N° art.: 793-506/000-005 Carte de repérage WMB; en carte; avec impression; 41 ... 50 (10x); non extensible; Impression horizontale; encliquetable</p>	www.wago.com/793-506/000-005
	<p>N° art.: 793-506/000-006 Carte de repérage WMB; en carte; avec impression; 41 ... 50 (10x); non extensible; Impression horizontale; encliquetable</p>	www.wago.com/793-506/000-006
	<p>N° art.: 793-506/000-012 Carte de repérage WMB; en carte; avec impression; 41 ... 50 (10x); non extensible; Impression horizontale; encliquetable</p>	www.wago.com/793-506/000-012
	<p>N° art.: 793-506/000-017 Carte de repérage WMB; en carte; avec impression; 41 ... 50 (10x); non extensible; Impression horizontale; encliquetable</p>	www.wago.com/793-506/000-017
	<p>N° art.: 793-5501 Carte de repérage WMB; en carte; largeur des bornes 5 - 17,5 mm; extensible 5 - 5,2 MM; vierge; encliquetable</p>	www.wago.com/793-5501
	<p>N° art.: 793-5501/000-002 Carte de repérage WMB; en carte; largeur des bornes 5 - 17,5 mm; extensible 5 - 5,2 MM; vierge; encliquetable</p>	www.wago.com/793-5501/000-002
	<p>N° art.: 793-5501/000-005 Carte de repérage WMB; en carte; extensible 5 - 5,2 MM; vierge; encliquetable</p>	www.wago.com/793-5501/000-005
	<p>N° art.: 793-5501/000-006 Carte de repérage WMB; en carte; extensible 5 - 5,2 MM; vierge; encliquetable</p>	www.wago.com/793-5501/000-006
	<p>N° art.: 793-5501/000-007 Carte de repérage WMB; en carte; extensible 5 - 5,2 MM; vierge; encliquetable</p>	www.wago.com/793-5501/000-007
	<p>N° art.: 793-5501/000-012 Carte de repérage WMB; en carte; extensible 5 - 5,2 MM; vierge; encliquetable</p>	www.wago.com/793-5501/000-012
	<p>N° art.: 793-5501/000-014 Carte de repérage WMB; en carte; extensible 5 - 5,2 MM; vierge; encliquetable</p>	www.wago.com/793-5501/000-014
	<p>N° art.: 793-5501/000-017 Carte de repérage WMB; en carte; extensible 5 - 5,2 MM; vierge; encliquetable</p>	www.wago.com/793-5501/000-017
	<p>N° art.: 793-5501/000-023 Carte de repérage WMB; en carte; extensible 5 - 5,2 MM; vierge; encliquetable</p>	www.wago.com/793-5501/000-023
	<p>N° art.: 793-5501/000-024 Carte de repérage WMB; en carte; extensible 5 - 5,2 MM; vierge; encliquetable</p>	www.wago.com/793-5501/000-024



N° art.: 793-566

Carte de repérage WMB; en carte; avec impression; 1 ... 50 (2x); non extensible; Impression horizontale; www.wago.com/793-566
encliquetable



N° art.: 793-566/000-002

Carte de repérage WMB; en carte; avec impression; 1 ... 50 (2x); non extensible; Impression horizontale; www.wago.com/793-566/000-002
encliquetable



N° art.: 793-566/000-005

Carte de repérage WMB; en carte; avec impression; 1 ... 50 (2x); non extensible; Impression horizontale; www.wago.com/793-566/000-005
encliquetable



N° art.: 793-566/000-006

Carte de repérage WMB; en carte; avec impression; 1 ... 50 (2x); non extensible; Impression horizontale; www.wago.com/793-566/000-006
encliquetable



N° art.: 793-566/000-007

Carte de repérage WMB; en carte; avec impression; 1 ... 50 (2x); non extensible; Impression horizontale; www.wago.com/793-566/000-007
encliquetable



N° art.: 793-566/000-012

Carte de repérage WMB; en carte; avec impression; 1 ... 50 (2x); non extensible; Impression horizontale; www.wago.com/793-566/000-012
encliquetable



N° art.: 793-566/000-017

Carte de repérage WMB; en carte; avec impression; 1 ... 50 (2x); non extensible; Impression horizontale; www.wago.com/793-566/000-017
encliquetable



N° art.: 793-566/000-023

Carte de repérage WMB; en carte; avec impression; 1 ... 50 (2x); non extensible; Impression horizontale; www.wago.com/793-566/000-023
encliquetable



N° art.: 793-566/000-024

Carte de repérage WMB; en carte; avec impression; 1 ... 50 (2x); non extensible; Impression horizontale; www.wago.com/793-566/000-024
encliquetable

Téléchargements

Documentation

Bid Text

788-512	Jan 15, 2016	DOC	Téléchargement
Relaisbaustein		28,2 kB	

Instruction Leaflet

Socket with Relay or SSR	Sep 28, 2015	PDF	Téléchargement
		2,1 MB	

Additional Information

Disposal; Electrical and electronic equipment, Packaging	V 1.0.0	PDF	Téléchargement
	Oct 15, 2018	269,1 kB	



smartDATA

CAD data

3D Download 788-512

URL

Téléchargement

Sous réserve de modifications.

WAGO Contact SAS
Paris Nord 2 - 83 rue des Chardonnerets
Tremblay-en-France
BP 55065

95947 Roissy CDG Cedex

Téléphone : 01 48 17 25 90 | Fax : 01 48 63 25 20

E-mail : info-fr@wago.com | Web : www.wago.fr

Avez-vous des questions sur nos produits ?

Nous nous tenons volontiers à votre disposition au +49 (571) 887-44222.