

Fiche technique | Numéro d'article: 788-608

Module relais; Tension nominale d'entrée AC 230 V; 1 RT; Limitation courant constant 16 A; avec contacts dorés; Indication d'état rouge; Largeur 15 mm

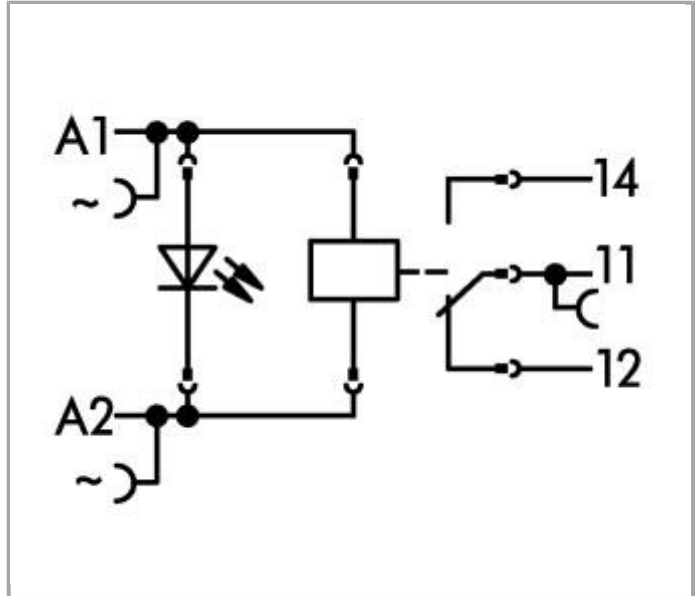

[www.wago.com/788-608](http://www.wago.com/788-608)

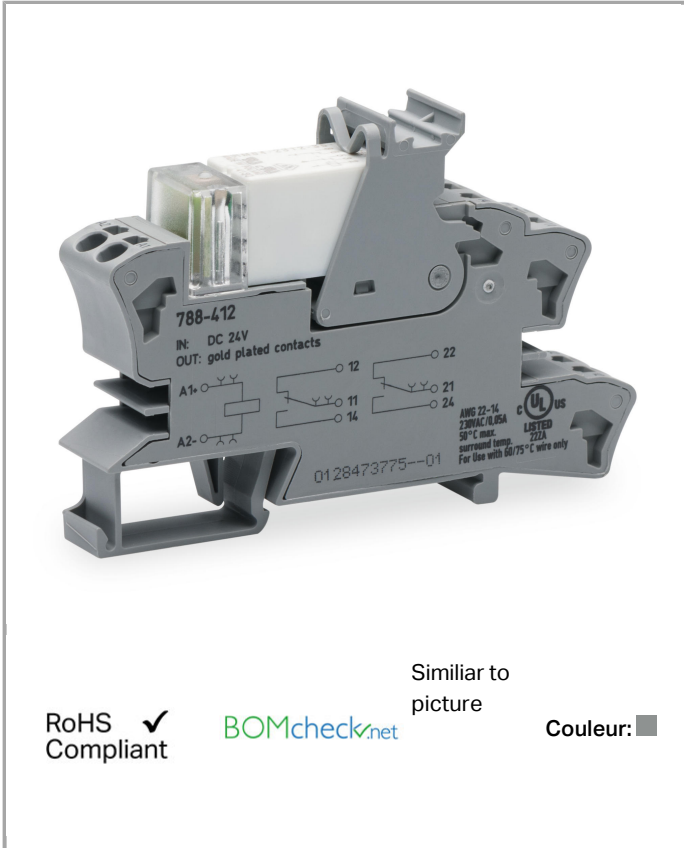

Similar to picture

RoHS  Compliant

[BOMcheck.net](http://BOMcheck.net)

Couleur: ■

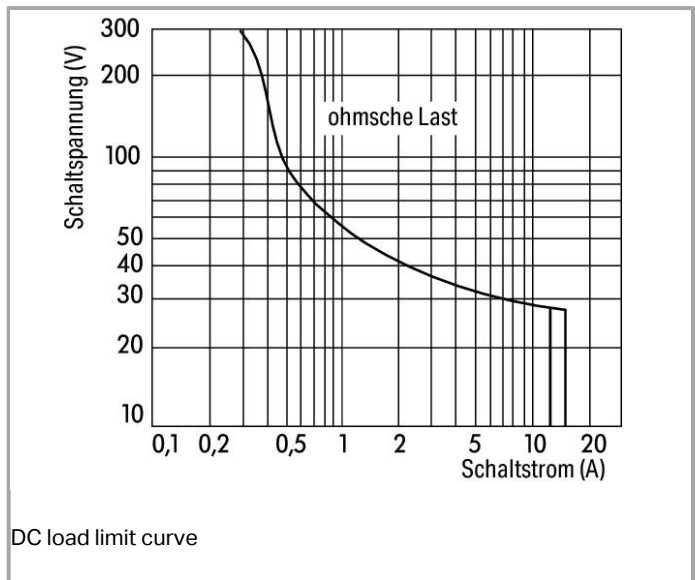
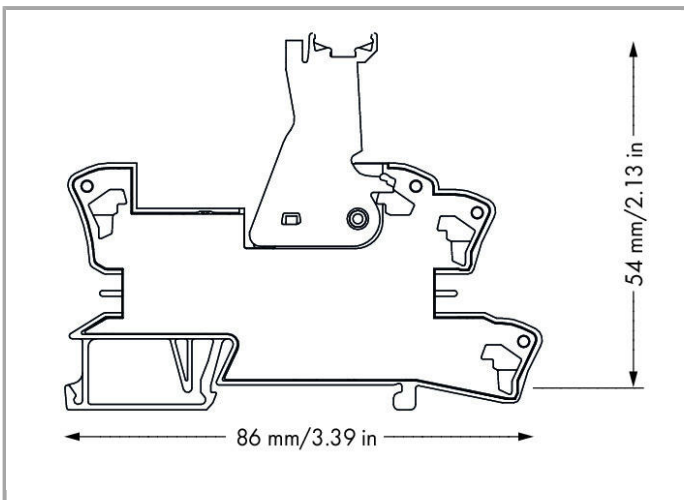

DC load limit curve

Description du produit :

**Note:****Remarques :**

- Isolation renforcée entre bobine et contacts
- Pour des tensions supérieures à 250 V entre modules relais connectés et pour respecter l'isolation renforcée, il faut utiliser un séparateur (par ex. 209-191).

\* Pour éviter un éventuel endommagement de la couche dorée, les tensions de commutation de 30 V DC et courants de 50 mA ne doivent pas être dépassés. Dans le cas de puissance de commutation plus élevée, la couche dorée se détériore. Des dépôts dans le boîtier peuvent conduire à une réduction de la durée de vie.

**Données****Données techniques****Circuit de commande**

Nominal input voltage $U_N$	230 VAC
Input voltage range	±10 %
Courant d'entrée nominal IN	5 mA

**Circuit de charge**

Nombre relais 1 T/contacts inverseurs	1
Contact material (relay)	AgNi + Au
Limiting continuous current	16 A
Max. switching voltage	250 VAC
Max. switching power (resistive)	4000 VAAC; DC see load limit curve
Switching capacity	AC-15: 6 A / 250 VAC; DC-13: 2 A / 24 VDC
Charge min. recommandée	5 V / 2 mA / 50 mW
Temps de montée typ.	7 ms
Temps de relâchement	3 ms
Electrical life (N.O.; resistive load; 23 °C)	30 x 10 <sup>3</sup> switching operations
Mechanical life (N.O.; resistive load; 23 °C)	30 x 10 <sup>6</sup> switching operations

**Signaling**

Indication d'état	LED red
-------------------	---------

**Sécurité & Protection**

Tension de référence	250 V
Tension assignée de tenue aux chocs	4 kV
Degré de pollution	3
Tension de claquage contact-bobine (AC, 1 min.)	5 kV <sub>rms</sub>

Dielectric strength, control/load circuit (AC, 1 min)	5 kV <sub>rms</sub>
Tension de claquage contact ouvert (AC, 1 min)	1 kV <sub>rms</sub>
Dielectric strength open contact (AC, 1 min)	1 kV <sub>rms</sub>
Indice de protection	IP20

### Données de raccordement

Technique de connexion	Push-in CAGE CLAMP®
Conducteur rigide	0,34 ... 2,5 mm <sup>2</sup> / 22 ... 14 AWG
Conducteur souple	0,34 ... 2,5 mm <sup>2</sup> / 22 ... 14 AWG
Longueur de dénudage	9 ... 10 mm / 0.35 ... 0.39 inch

### Données géométriques

Largeur	15 mm / 0.591 inch
Profondeur à partir du niveau supérieur du rail	54 mm / 2.126 inch
Profondeur	86 mm / 3.386 inch

### Données mécaniques

Type de montage	Rail 35
-----------------	---------

### Données du matériau

Couleur	gris
Charge calorifique	0.89 MJ
Poids	47.546 g

### Conditions d'environnement

Température ambiante admissible Fonctionnement pour U <sub>N</sub>	-25 ... 70 °C
Température ambiante (stockage)	-40 ... 70 °C
Degré de pollution	3

### Normes et spécifications

Normes/spécifications	EN 61010-2-201; EN 61810-1; EN 61373; UL 508
-----------------------	----------------------------------------------

### Elementary relay

WAGO elementary relay	788-179
-----------------------	---------

### Dates commerciales

Country of origin	DE
-------------------	----

GTIN	4045454484798
Customs Tariff No.	85364900990
Product Group	6 (Interface Electronics)

## Autorisations / certificats

### Approbations de navire







Logo	Approbation	Nom du certificat
	<b>DNV GL</b> Det Norske Veritas, Germanischer Lloyd	TAA00001D1
	<b>NK</b> Nippon Kaiji Kyokai	TA17255M
	<b>PRS</b> Polski Rejestr Statkow	TE/1989/880590/13

### Approbations UL

Logo	Approbation	Nom du certificat
	<b>UL</b> UL International Netherlands B.V. (ORDINARY LOCATIONS)	E175199 Sec.6

## Produits correspondants

### General accessories

	<b>N° art.: 209-145</b> Porte-étiquettes de groupe	<a href="http://www.wago.com/209-145">www.wago.com/209-145</a>
	<b>N° art.: 209-184</b> Protège-étiquettes	<a href="http://www.wago.com/209-184">www.wago.com/209-184</a>
	<b>N° art.: 249-105</b> Porte-étiquettes de groupe	<a href="http://www.wago.com/249-105">www.wago.com/249-105</a>
	<b>N° art.: 788-125</b> Accessoire pour module relais; Etat de fonctionnement rouge	<a href="http://www.wago.com/788-125">www.wago.com/788-125</a>
	<b>N° art.: 788-148</b> Module de filtrage; élément de filtre RC; Tension nominale AC 230 V	<a href="http://www.wago.com/788-148">www.wago.com/788-148</a>
	<b>N° art.: 788-179</b> Relais de couplage; Tension nominale d'entrée AC 230 V; 1 RT; Limitation courant constant 16 A; avec contacts dorés; Largeur 13 mm; Hauteur du relais 15 mm	<a href="http://www.wago.com/788-179">www.wago.com/788-179</a>

### tools



**N° art.: 210-720**  
Outil de manipulation, partiellement isolé; Type 2, lame (3,5 x 0,5) mm

[www.wago.com/210-720](http://www.wago.com/210-720)

### Jumper



**N° art.: 788-118**  
Peigne de pontage; 2 pôles (1-3); isolé

[www.wago.com/788-118](http://www.wago.com/788-118)



**N° art.: 859-402**  
Peigne de pontage; 2 raccords; Courant nominal 18 A; isolé

[www.wago.com/859-402](http://www.wago.com/859-402)



**N° art.: 859-402/000-005**  
Peigne de pontage; 2 raccords; Courant nominal 18 A; isolé

[www.wago.com/859-402/000-005](http://www.wago.com/859-402/000-005)



**N° art.: 859-402/000-006**  
Peigne de pontage; 2 raccords; Courant nominal 18 A; isolé

[www.wago.com/859-402/000-006](http://www.wago.com/859-402/000-006)



**N° art.: 859-402/000-029**  
Peigne de pontage; 2 raccords; Courant nominal 18 A; isolé

[www.wago.com/859-402/000-029](http://www.wago.com/859-402/000-029)

### Marking accessories



**N° art.: 2009-110**  
Bandes de marquage; sur rouleau; non extensible; vierge; encliquetable

[www.wago.com/2009-110](http://www.wago.com/2009-110)



**N° art.: 2009-115**  
WMB-Inline; pour smartPRINTER; sur rouleau; extensible 5 - 5,2 MM; vierge; encliquetable

[www.wago.com/2009-115](http://www.wago.com/2009-115)



**N° art.: 2009-115/000-002**  
WMB-Inline; pour smartPRINTER; sur rouleau; extensible 5 - 5,2 MM; vierge; encliquetable

[www.wago.com/2009-115/000-002](http://www.wago.com/2009-115/000-002)



**N° art.: 2009-115/000-006**  
WMB-Inline; pour smartPRINTER; sur rouleau; extensible 5 - 5,2 MM; vierge; encliquetable

[www.wago.com/2009-115/000-006](http://www.wago.com/2009-115/000-006)



**N° art.: 2009-115/000-007**  
WMB-Inline; sur rouleau; extensible 5 - 5,2 MM; vierge; encliquetable

[www.wago.com/2009-115/000-007](http://www.wago.com/2009-115/000-007)



**N° art.: 2009-115/000-012**  
WMB-Inline; pour smartPRINTER; sur rouleau; extensible 5 - 5,2 MM; vierge; encliquetable

[www.wago.com/2009-115/000-012](http://www.wago.com/2009-115/000-012)



**N° art.: 2009-115/000-017**  
WMB-Inline; sur rouleau; extensible 5 - 5,2 MM; vierge; encliquetable

[www.wago.com/2009-115/000-017](http://www.wago.com/2009-115/000-017)

















**N° art.: 2009-115/000-023**  
WMB-Inline; pour smartPRINTER; sur rouleau; extensible 5 - 5,2 MM; vierge; encliquetable















[www.wago.com/2009-115/000-023](http://www.wago.com/2009-115/000-023)

















**N° art.: 209-128**  
Adaptateur















[www.wago.com/209-128](http://www.wago.com/209-128)

	<b>N° art.: 209-183</b> Étiquette à enficher	<a href="http://www.wago.com/209-183">www.wago.com/209-183</a>
	<b>N° art.: 210-110</b> Stylo feutre-graveur	<a href="http://www.wago.com/210-110">www.wago.com/210-110</a>
	<b>N° art.: 793-501</b> Carte de repérage WMB; en carte; non extensible; vierge; encliquetable	<a href="http://www.wago.com/793-501">www.wago.com/793-501</a>
	<b>N° art.: 793-501/000-002</b> Carte de repérage WMB; en carte; non extensible; vierge; encliquetable	<a href="http://www.wago.com/793-501/000-002">www.wago.com/793-501/000-002</a>
	<b>N° art.: 793-501/000-005</b> Carte de repérage WMB; en carte; non extensible; vierge; encliquetable	<a href="http://www.wago.com/793-501/000-005">www.wago.com/793-501/000-005</a>
	<b>N° art.: 793-501/000-006</b> Carte de repérage WMB; en carte; non extensible; vierge; encliquetable	<a href="http://www.wago.com/793-501/000-006">www.wago.com/793-501/000-006</a>
	<b>N° art.: 793-501/000-007</b> Carte de repérage WMB; en carte; non extensible; vierge; encliquetable	<a href="http://www.wago.com/793-501/000-007">www.wago.com/793-501/000-007</a>
	<b>N° art.: 793-501/000-012</b> Carte de repérage WMB; en carte; non extensible; vierge; encliquetable	<a href="http://www.wago.com/793-501/000-012">www.wago.com/793-501/000-012</a>
	<b>N° art.: 793-501/000-017</b> Carte de repérage WMB; en carte; non extensible; vierge; encliquetable	<a href="http://www.wago.com/793-501/000-017">www.wago.com/793-501/000-017</a>
	<b>N° art.: 793-501/000-023</b> Carte de repérage WMB; en carte; non extensible; vierge; encliquetable	<a href="http://www.wago.com/793-501/000-023">www.wago.com/793-501/000-023</a>
	<b>N° art.: 793-501/000-024</b> Carte de repérage WMB; en carte; non extensible; vierge; encliquetable	<a href="http://www.wago.com/793-501/000-024">www.wago.com/793-501/000-024</a>
	<b>N° art.: 793-502</b> Carte de repérage WMB; en carte; avec impression; 1 ... 10 (10x); non extensible; Impression horizontale; encliquetable	<a href="http://www.wago.com/793-502">www.wago.com/793-502</a>
	<b>N° art.: 793-502/000-002</b> Carte de repérage WMB; en carte; avec impression; 1 ... 10 (10x); non extensible; Impression horizontale; encliquetable	<a href="http://www.wago.com/793-502/000-002">www.wago.com/793-502/000-002</a>
	<b>N° art.: 793-502/000-005</b> Carte de repérage WMB; en carte; avec impression; 1 ... 10 (10x); non extensible; Impression horizontale; encliquetable	<a href="http://www.wago.com/793-502/000-005">www.wago.com/793-502/000-005</a>
	<b>N° art.: 793-502/000-006</b> Carte de repérage WMB; en carte; avec impression; 1 ... 10 (10x); non extensible; Impression horizontale; encliquetable	<a href="http://www.wago.com/793-502/000-006">www.wago.com/793-502/000-006</a>
	<b>N° art.: 793-502/000-007</b> Carte de repérage WMB; en carte; avec impression; 1 ... 10 (10x); non extensible; Impression	

	horizontale; encliquetable	<a href="http://www.wago.com/793-502/000-007">www.wago.com/793-502/000-007</a>
	<b>N° art.: 793-502/000-012</b> Carte de repérage WMB; en carte; avec impression; 1 ... 10 (10x); non extensible; Impression horizontale; encliquetable	<a href="http://www.wago.com/793-502/000-012">www.wago.com/793-502/000-012</a>
	<b>N° art.: 793-502/000-017</b> Carte de repérage WMB; en carte; avec impression; 1 ... 10 (10x); non extensible; Impression horizontale; encliquetable	<a href="http://www.wago.com/793-502/000-017">www.wago.com/793-502/000-017</a>
	<b>N° art.: 793-502/000-023</b> Carte de repérage WMB; en carte; avec impression; 1 ... 10 (10x); non extensible; Impression horizontale; encliquetable	<a href="http://www.wago.com/793-502/000-023">www.wago.com/793-502/000-023</a>
	<b>N° art.: 793-502/000-024</b> Carte de repérage WMB; en carte; avec impression; 1 ... 10 (10x); non extensible; Impression horizontale; encliquetable	<a href="http://www.wago.com/793-502/000-024">www.wago.com/793-502/000-024</a>
	<b>N° art.: 793-503</b> Carte de repérage WMB; en carte; avec impression; 11 ... 20 (10x); non extensible; Impression horizontale; encliquetable	<a href="http://www.wago.com/793-503">www.wago.com/793-503</a>
	<b>N° art.: 793-503/000-002</b> Carte de repérage WMB; en carte; avec impression; 11 ... 20 (10x); non extensible; Impression horizontale; encliquetable	<a href="http://www.wago.com/793-503/000-002">www.wago.com/793-503/000-002</a>
	<b>N° art.: 793-503/000-005</b> Carte de repérage WMB; en carte; avec impression; 11 ... 20 (10x); non extensible; Impression horizontale; encliquetable	<a href="http://www.wago.com/793-503/000-005">www.wago.com/793-503/000-005</a>
	<b>N° art.: 793-503/000-006</b> Carte de repérage WMB; en carte; avec impression; 11 ... 20 (10x); non extensible; Impression horizontale; encliquetable	<a href="http://www.wago.com/793-503/000-006">www.wago.com/793-503/000-006</a>
	<b>N° art.: 793-503/000-007</b> Carte de repérage WMB; en carte; avec impression; 11 ... 20 (10x); non extensible; Impression horizontale; encliquetable	<a href="http://www.wago.com/793-503/000-007">www.wago.com/793-503/000-007</a>
	<b>N° art.: 793-503/000-012</b> Carte de repérage WMB; en carte; avec impression; 11 ... 20 (10x); non extensible; Impression horizontale; encliquetable	<a href="http://www.wago.com/793-503/000-012">www.wago.com/793-503/000-012</a>
	<b>N° art.: 793-503/000-017</b> Carte de repérage WMB; en carte; avec impression; 11 ... 20 (10x); non extensible; Impression horizontale; encliquetable	<a href="http://www.wago.com/793-503/000-017">www.wago.com/793-503/000-017</a>
	<b>N° art.: 793-503/000-023</b> Carte de repérage WMB; en carte; avec impression; 11 ... 20 (10x); non extensible; Impression horizontale; encliquetable	<a href="http://www.wago.com/793-503/000-023">www.wago.com/793-503/000-023</a>
	<b>N° art.: 793-503/000-024</b> Carte de repérage WMB; en carte; avec impression; 11 ... 20 (10x); non extensible; Impression horizontale; encliquetable	<a href="http://www.wago.com/793-503/000-024">www.wago.com/793-503/000-024</a>
	<b>N° art.: 793-504</b> Carte de repérage WMB; en carte; avec impression; 21 ... 30 (10x); non extensible; Impression horizontale; encliquetable	<a href="http://www.wago.com/793-504">www.wago.com/793-504</a>

	<p><b>N° art.: 793-504/000-002</b>                      Carte de repérage WMB; en carte; avec impression; 21 ... 30 (10x); non extensible; Impression horizontale; encliquetable</p>	<a href="http://www.wago.com/793-504/000-002">www.wago.com/793-504/000-002</a>
	<p><b>N° art.: 793-504/000-005</b>                      Carte de repérage WMB; en carte; avec impression; 21 ... 30 (10x); non extensible; Impression horizontale; encliquetable</p>	<a href="http://www.wago.com/793-504/000-005">www.wago.com/793-504/000-005</a>
	<p><b>N° art.: 793-504/000-006</b>                      Carte de repérage WMB; en carte; avec impression; 21 ... 30 (10x); non extensible; Impression horizontale; encliquetable</p>	<a href="http://www.wago.com/793-504/000-006">www.wago.com/793-504/000-006</a>
	<p><b>N° art.: 793-504/000-012</b>                      Carte de repérage WMB; en carte; avec impression; 21 ... 30 (10x); non extensible; Impression horizontale; encliquetable</p>	<a href="http://www.wago.com/793-504/000-012">www.wago.com/793-504/000-012</a>
	<p><b>N° art.: 793-504/000-017</b>                      Carte de repérage WMB; en carte; avec impression; 21 ... 30 (10x); non extensible; Impression horizontale; encliquetable</p>	<a href="http://www.wago.com/793-504/000-017">www.wago.com/793-504/000-017</a>
	<p><b>N° art.: 793-504/000-023</b>                      Carte de repérage WMB; en carte; avec impression; 21 ... 30 (10x); non extensible; Impression horizontale; encliquetable</p>	<a href="http://www.wago.com/793-504/000-023">www.wago.com/793-504/000-023</a>
	<p><b>N° art.: 793-505</b>                      Carte de repérage WMB; en carte; avec impression; 31 ... 40 (10x); non extensible; Impression horizontale; encliquetable</p>	<a href="http://www.wago.com/793-505">www.wago.com/793-505</a>
	<p><b>N° art.: 793-505/000-005</b>                      Carte de repérage WMB; en carte; avec impression; 31 ... 40 (10x); non extensible; Impression horizontale; encliquetable</p>	<a href="http://www.wago.com/793-505/000-005">www.wago.com/793-505/000-005</a>
	<p><b>N° art.: 793-505/000-006</b>                      Carte de repérage WMB; en carte; avec impression; 31 ... 40 (10x); non extensible; Impression horizontale; encliquetable</p>	<a href="http://www.wago.com/793-505/000-006">www.wago.com/793-505/000-006</a>
	<p><b>N° art.: 793-505/000-007</b>                      Carte de repérage WMB; en carte; avec impression; 31 ... 40 (10x); non extensible; Impression horizontale; encliquetable</p>	<a href="http://www.wago.com/793-505/000-007">www.wago.com/793-505/000-007</a>
	<p><b>N° art.: 793-505/000-012</b>                      Carte de repérage WMB; en carte; avec impression; 31 ... 40 (10x); non extensible; Impression horizontale; encliquetable</p>	<a href="http://www.wago.com/793-505/000-012">www.wago.com/793-505/000-012</a>
	<p><b>N° art.: 793-506</b>                      Carte de repérage WMB; en carte; avec impression; 41 ... 50 (10x); non extensible; Impression horizontale; encliquetable</p>	<a href="http://www.wago.com/793-506">www.wago.com/793-506</a>
	<p><b>N° art.: 793-506/000-005</b>                      Carte de repérage WMB; en carte; avec impression; 41 ... 50 (10x); non extensible; Impression horizontale; encliquetable</p>	<a href="http://www.wago.com/793-506/000-005">www.wago.com/793-506/000-005</a>
	<p><b>N° art.: 793-506/000-006</b>                      Carte de repérage WMB; en carte; avec impression; 41 ... 50 (10x); non extensible; Impression horizontale; encliquetable</p>	<a href="http://www.wago.com/793-506/000-006">www.wago.com/793-506/000-006</a>
	<p><b>N° art.: 793-506/000-012</b>                      Carte de repérage WMB; en carte; avec impression; 41 ... 50 (10x); non extensible; Impression horizontale; encliquetable</p>	<a href="http://www.wago.com/793-506/000-012">www.wago.com/793-506/000-012</a>



	<b>N° art.: 793-506/000-017</b> Carte de repérage WMB; en carte; avec impression; 41 ... 50 (10x); non extensible; Impression horizontale; encliquetable	<a href="http://www.wago.com/793-506/000-017">www.wago.com/793-506/000-017</a>
	<b>N° art.: 793-5501</b> Carte de repérage WMB; en carte; largeur des bornes 5 - 17,5 mm; extensible 5 - 5,2 MM; vierge; encliquetable	<a href="http://www.wago.com/793-5501">www.wago.com/793-5501</a>
	<b>N° art.: 793-5501/000-002</b> Carte de repérage WMB; en carte; largeur des bornes 5 - 17,5 mm; extensible 5 - 5,2 MM; vierge; encliquetable	<a href="http://www.wago.com/793-5501/000-002">www.wago.com/793-5501/000-002</a>
	<b>N° art.: 793-5501/000-005</b> Carte de repérage WMB; en carte; extensible 5 - 5,2 MM; vierge; encliquetable	<a href="http://www.wago.com/793-5501/000-005">www.wago.com/793-5501/000-005</a>
	<b>N° art.: 793-5501/000-006</b> Carte de repérage WMB; en carte; extensible 5 - 5,2 MM; vierge; encliquetable	<a href="http://www.wago.com/793-5501/000-006">www.wago.com/793-5501/000-006</a>
	<b>N° art.: 793-5501/000-007</b> Carte de repérage WMB; en carte; extensible 5 - 5,2 MM; vierge; encliquetable	<a href="http://www.wago.com/793-5501/000-007">www.wago.com/793-5501/000-007</a>
	<b>N° art.: 793-5501/000-012</b> Carte de repérage WMB; en carte; extensible 5 - 5,2 MM; vierge; encliquetable	<a href="http://www.wago.com/793-5501/000-012">www.wago.com/793-5501/000-012</a>
	<b>N° art.: 793-5501/000-014</b> Carte de repérage WMB; en carte; extensible 5 - 5,2 MM; vierge; encliquetable	<a href="http://www.wago.com/793-5501/000-014">www.wago.com/793-5501/000-014</a>
	<b>N° art.: 793-5501/000-017</b> Carte de repérage WMB; en carte; extensible 5 - 5,2 MM; vierge; encliquetable	<a href="http://www.wago.com/793-5501/000-017">www.wago.com/793-5501/000-017</a>
	<b>N° art.: 793-5501/000-023</b> Carte de repérage WMB; en carte; extensible 5 - 5,2 MM; vierge; encliquetable	<a href="http://www.wago.com/793-5501/000-023">www.wago.com/793-5501/000-023</a>
	<b>N° art.: 793-5501/000-024</b> Carte de repérage WMB; en carte; extensible 5 - 5,2 MM; vierge; encliquetable	<a href="http://www.wago.com/793-5501/000-024">www.wago.com/793-5501/000-024</a>
	<b>N° art.: 793-566</b> Carte de repérage WMB; en carte; avec impression; 1 ... 50 (2x); non extensible; Impression horizontale; encliquetable	<a href="http://www.wago.com/793-566">www.wago.com/793-566</a>
	<b>N° art.: 793-566/000-002</b> Carte de repérage WMB; en carte; avec impression; 1 ... 50 (2x); non extensible; Impression horizontale; encliquetable	<a href="http://www.wago.com/793-566/000-002">www.wago.com/793-566/000-002</a>
	<b>N° art.: 793-566/000-005</b> Carte de repérage WMB; en carte; avec impression; 1 ... 50 (2x); non extensible; Impression horizontale; encliquetable	<a href="http://www.wago.com/793-566/000-005">www.wago.com/793-566/000-005</a>
	<b>N° art.: 793-566/000-006</b> Carte de repérage WMB; en carte; avec impression; 1 ... 50 (2x); non extensible; Impression horizontale; encliquetable	<a href="http://www.wago.com/793-566/000-006">www.wago.com/793-566/000-006</a>



N° art.: 793-566/000-007

Carte de repérage WMB; en carte; avec impression; 1 ... 50 (2x); non extensible; Impression horizontale; encliquetable

[www.wago.com/793-566/000-007](http://www.wago.com/793-566/000-007)



N° art.: 793-566/000-012

Carte de repérage WMB; en carte; avec impression; 1 ... 50 (2x); non extensible; Impression horizontale; encliquetable

[www.wago.com/793-566/000-012](http://www.wago.com/793-566/000-012)



N° art.: 793-566/000-017

Carte de repérage WMB; en carte; avec impression; 1 ... 50 (2x); non extensible; Impression horizontale; encliquetable

[www.wago.com/793-566/000-017](http://www.wago.com/793-566/000-017)



N° art.: 793-566/000-023

Carte de repérage WMB; en carte; avec impression; 1 ... 50 (2x); non extensible; Impression horizontale; encliquetable

[www.wago.com/793-566/000-023](http://www.wago.com/793-566/000-023)



N° art.: 793-566/000-024

Carte de repérage WMB; en carte; avec impression; 1 ... 50 (2x); non extensible; Impression horizontale; encliquetable

[www.wago.com/793-566/000-024](http://www.wago.com/793-566/000-024)

## ferrule



N° art.: 216-241

Embout d'extrémité; embout pour 0,5 mm<sup>2</sup> / AWG 22; avec isolation plastique; étamés par électrolyse; Cuivre électrolytique; serti de manière étanche aux gaz; selon DIN 46228, partie 4/09.90

[www.wago.com/216-241](http://www.wago.com/216-241)



N° art.: 216-242

Embout d'extrémité; embout pour 0,75 mm<sup>2</sup> / AWG 20; avec isolation plastique; étamés par électrolyse; Cuivre électrolytique; serti de manière étanche aux gaz; selon DIN 46228, partie 4/09.90

[www.wago.com/216-242](http://www.wago.com/216-242)



N° art.: 216-243

Embout d'extrémité; embout pour 1 mm<sup>2</sup> / AWG 18; avec isolation plastique; étamés par électrolyse; Cuivre électrolytique; serti de manière étanche aux gaz; selon DIN 46228, partie 4/09.90

[www.wago.com/216-243](http://www.wago.com/216-243)



N° art.: 216-244

Embout d'extrémité; embout pour 1,5 mm<sup>2</sup> / AWG 16; avec isolation plastique; étamés par électrolyse; Cuivre électrolytique; serti de manière étanche aux gaz; selon DIN 46228, partie 4/09.90

[www.wago.com/216-244](http://www.wago.com/216-244)



N° art.: 216-542

Embout d'extrémité double; Embout pour 2 x 1 mm<sup>2</sup> / AWG 2 x 18; rouge, isolé; longueur 12 mm

[www.wago.com/216-542](http://www.wago.com/216-542)

## Téléchargements

### Documentation

#### Bid Text

788-608 Relaisbaustein	Jan 15, 2016	DOC 28,2 kB	Téléchargement
---------------------------	--------------	----------------	----------------

#### Instruction Leaflet

Socket with Relay or SSR	Sep 28, 2015	PDF 2,1 MB	Téléchargement
--------------------------	--------------	---------------	----------------

#### Additional Information

Disposal; Electrical and electronic equipment, Packaging	V 1.0.0	PDF	Téléchargement
----------------------------------------------------------	---------	-----	----------------



Oct 15, 2018

269,1 kB

---

**smartDATA**

**CAD data**

3D Download 788-608

URL

Téléchargement

---

Sous réserve de modifications.