

Fiche technique | Numéro d'article: 788-615

Module relais; Tension nominale d'entrée AC 115 V; 2 RT; Limitation courant constant 8 A; avec contacts dorés; Indication d'état rouge; Largeur 15 mm

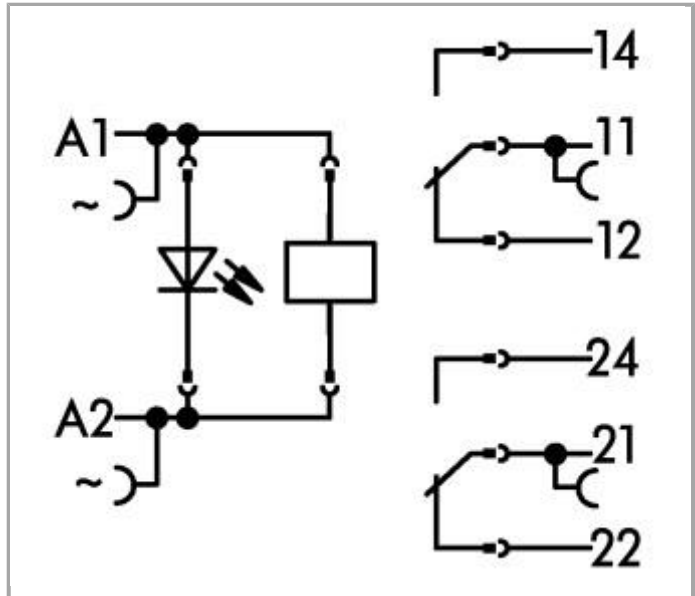

www.wago.com/788-615

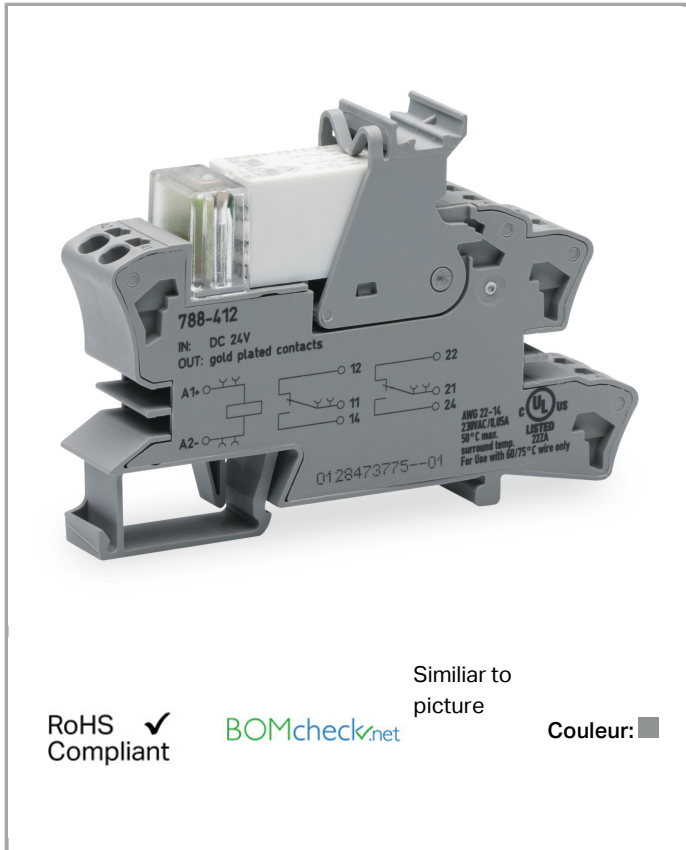

RoHS Compliant ✓ BOMcheck.net Similar to picture Couleur: ■

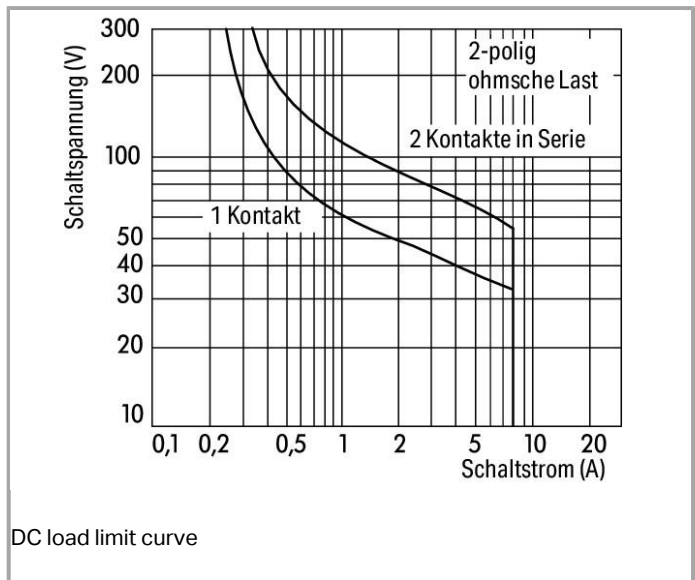
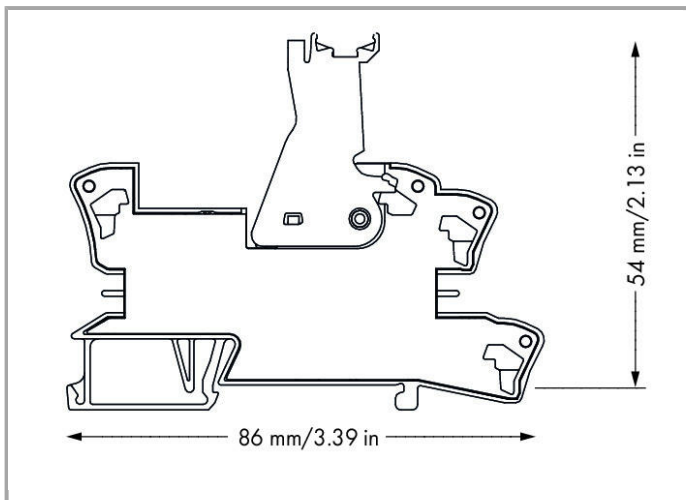

Description du produit :

Note:**Remarques :**

- Isolation renforcée entre bobine et contacts
- Pour des tensions supérieures à 250 V entre modules relais connectés et pour respecter l'isolation renforcée, il faut utiliser un séparateur (par ex. 209-191).

* Pour éviter un éventuel endommagement de la couche dorée, les tensions de commutation de 30 V DC et courants de 50 mA ne doivent pas être dépassés. Dans le cas de puissance de commutation plus élevée, la couche dorée se détériore. Des dépôts dans le boîtier peuvent conduire à une réduction de la durée de vie.

Données**Données techniques****Circuit de commande**

Nominal input voltage U_N	115 VAC
Input voltage range	±10 %
Courant d'entrée nominal IN	8.2 mA

Circuit de charge

Nombre relais 1 T/contacts inverseurs	2
Contact material (relay)	AgNi + Au
Limiting continuous current	8 A
Max. switching voltage	250 VAC
Max. switching power (resistive)	2000 VAAC; DC see load limit curve
Switching capacity	AC-15: 3 A / 250 VAC; DC-13: 2 A / 24 VDC
Charge min. recommandée	5 V / 2 mA / 50 mW
Temps de montée typ.	7 ms
Temps de relâchement	3 ms
Electrical life (N.O.; resistive load; 23 °C)	1 x 10 ³ switching operations
Mechanical life (N.O.; resistive load; 23 °C)	30 x 10 ⁶ switching operations

Signaling

Indication d'état	LED red
-------------------	---------

Sécurité & Protection

Tension de référence	250 V
Tension assignée de tenue aux chocs	4 kV
Degré de pollution	3
Tension de claquage contact-bobine (AC, 1 min.)	5 kV _{rms}

Dielectric strength, control/load circuit (AC, 1 min)	5 kV _{rms}
Tension de claquage contact ouvert (AC, 1 min)	1 kV _{rms}
Dielectric strength open contact (AC, 1 min)	1 kV _{rms}
Tension de claquage, contact adjacent (AC, 1 min)	2.5 kV _{rms}
Dielectric strength, load/load circuit (AC, 1 min)	2,5 kV _{rms}
Indice de protection	IP20

Données de raccordement

Technique de connexion	Push-in CAGE CLAMP®
Conducteur rigide	0,34 ... 2,5 mm ² / 22 ... 14 AWG
Conducteur souple	0,34 ... 2,5 mm ² / 22 ... 14 AWG
Longueur de dénudage	9 ... 10 mm / 0.35 ... 0.39 inch

Données géométriques

Largeur	15 mm / 0.591 inch
Profondeur à partir du niveau supérieur du rail	54 mm / 2.126 inch
Profondeur	86 mm / 3.386 inch

Données mécaniques

Type de montage	Rail 35
-----------------	---------

Données du matériau

Couleur	gris
Poids	47.027 g

Conditions d'environnement

Température ambiante admissible Fonctionnement pour U _N	-25 ... 70 °C
Température ambiante (stockage)	-40 ... 70 °C
Degré de pollution	3

Normes et spécifications

Normes/spécifications	EN 61010-2-201; EN 61810-1; EN 61373; UL 508
-----------------------	--

Elementary relay

WAGO elementary relay	788-177
-----------------------	---------

Dates commerciales

Country of origin	DE
GTIN	4045454389536
Customs Tariff No.	85364900990
Product Group	6 (Interface Electronics)

Autorisations / certificats

Approbations de navire





Logo	Approbation	Nom du certificat
	DNV GL Det Norske Veritas, Germanischer Lloyd	TAA00001D1
	NK Nippon Kaiji Kyokai	TA17255M
	PRS Polski Rejestr Statkow	TE/1989/880590/13

Approbations UL

Logo	Approbation	Nom du certificat
	UL UL International Netherlands B.V. (ORDINARY LOCATIONS)	E175199 Sec.6

Produits correspondants





General accessories

	N° art.: 209-145 Porte-étiquettes de groupe	www.wago.com/209-145
	N° art.: 209-184 Protège-étiquettes	www.wago.com/209-184
	N° art.: 249-105 Porte-étiquettes de groupe	www.wago.com/249-105
	N° art.: 788-124 Accessoire pour module relais; Etat de fonctionnement rouge	www.wago.com/788-124
	N° art.: 788-148 Module de filtrage; élément de filtre RC; Tension nominale AC 230 V	www.wago.com/788-148
	N° art.: 788-177 Relais de couplage; Tension nominale d'entrée AC 115 V; 2 RT; Limitation courant constant 8 A; avec	www.wago.com/788-177



contacts dorés; Largeur 13 mm; Hauteur du relais 15 mm





ferrule

	N° art.: 216-241 Embout d'extrémité; embout pour 0,5 mm ² / AWG 22; avec isolation plastique; étamés par électrolyse; Cuivre électrolytique; serti de manière étanche aux gaz; selon DIN 46228, partie 4/09.90	www.wago.com/216-241
	N° art.: 216-242 Embout d'extrémité; embout pour 0,75 mm ² / AWG 20; avec isolation plastique; étamés par électrolyse; Cuivre électrolytique; serti de manière étanche aux gaz; selon DIN 46228, partie 4/09.90	www.wago.com/216-242
	N° art.: 216-243 Embout d'extrémité; embout pour 1 mm ² / AWG 18; avec isolation plastique; étamés par électrolyse; Cuivre électrolytique; serti de manière étanche aux gaz; selon DIN 46228, partie 4/09.90	www.wago.com/216-243
	N° art.: 216-244 Embout d'extrémité; embout pour 1,5 mm ² / AWG 16; avec isolation plastique; étamés par électrolyse; Cuivre électrolytique; serti de manière étanche aux gaz; selon DIN 46228, partie 4/09.90	www.wago.com/216-244
	N° art.: 216-542 Embout d'extrémité double; Embout pour 2 x 1 mm ² / AWG 2 x 18; rouge, isolé; longueur 12 mm	www.wago.com/216-542



tools

















	N° art.: 210-720 Outil de manipulation, partiellement isolé; Type 2, lame (3,5 x 0,5) mm	www.wago.com/210-720
--	--	--















Jumper

	N° art.: 788-118 Peigne de pontage; 2 pôles (1-3); isolé	www.wago.com/788-118
	N° art.: 859-402 Peigne de pontage; 2 raccords; Courant nominal 18 A; isolé	www.wago.com/859-402
	N° art.: 859-402/000-005 Peigne de pontage; 2 raccords; Courant nominal 18 A; isolé	www.wago.com/859-402/000-005
	N° art.: 859-402/000-006 Peigne de pontage; 2 raccords; Courant nominal 18 A; isolé	www.wago.com/859-402/000-006
	N° art.: 859-402/000-029 Peigne de pontage; 2 raccords; Courant nominal 18 A; isolé	www.wago.com/859-402/000-029

Marking accessories

	N° art.: 2009-110 Bandes de marquage; sur rouleau; non extensible; vierge; encliquetable	www.wago.com/2009-110
	N° art.: 2009-115 WMB-Inline; pour smartPRINTER; sur rouleau; extensible 5 - 5,2 MM; vierge; encliquetable	www.wago.com/2009-115
	N° art.: 2009-115/000-002 WMB-Inline; pour smartPRINTER; sur rouleau; extensible 5 - 5,2 MM; vierge; encliquetable	www.wago.com/2009-115/000-002

	<p>N° art.: 2009-115/000-006 WMB-Inline; pour smartPRINTER; sur rouleau; extensible 5 - 5,2 MM; vierge; encliquetable</p>	www.wago.com/2009-115/000-006
	<p>N° art.: 2009-115/000-007 WMB-Inline; sur rouleau; extensible 5 - 5,2 MM; vierge; encliquetable</p>	www.wago.com/2009-115/000-007
	<p>N° art.: 2009-115/000-012 WMB-Inline; pour smartPRINTER; sur rouleau; extensible 5 - 5,2 MM; vierge; encliquetable</p>	www.wago.com/2009-115/000-012
	<p>N° art.: 2009-115/000-017 WMB-Inline; sur rouleau; extensible 5 - 5,2 MM; vierge; encliquetable</p>	www.wago.com/2009-115/000-017
	<p>N° art.: 2009-115/000-023 WMB-Inline; pour smartPRINTER; sur rouleau; extensible 5 - 5,2 MM; vierge; encliquetable</p>	www.wago.com/2009-115/000-023
	<p>N° art.: 209-128 Adaptateur</p>	www.wago.com/209-128
	<p>N° art.: 209-183 Étiquette à enficher</p>	www.wago.com/209-183
	<p>N° art.: 210-110 Stylo feutre-graveur</p>	www.wago.com/210-110
	<p>N° art.: 793-501 Carte de repérage WMB; en carte; non extensible; vierge; encliquetable</p>	www.wago.com/793-501
	<p>N° art.: 793-501/000-002 Carte de repérage WMB; en carte; non extensible; vierge; encliquetable</p>	www.wago.com/793-501/000-002
	<p>N° art.: 793-501/000-005 Carte de repérage WMB; en carte; non extensible; vierge; encliquetable</p>	www.wago.com/793-501/000-005
	<p>N° art.: 793-501/000-006 Carte de repérage WMB; en carte; non extensible; vierge; encliquetable</p>	www.wago.com/793-501/000-006
	<p>N° art.: 793-501/000-007 Carte de repérage WMB; en carte; non extensible; vierge; encliquetable</p>	www.wago.com/793-501/000-007
	<p>N° art.: 793-501/000-012 Carte de repérage WMB; en carte; non extensible; vierge; encliquetable</p>	www.wago.com/793-501/000-012
	<p>N° art.: 793-501/000-017 Carte de repérage WMB; en carte; non extensible; vierge; encliquetable</p>	www.wago.com/793-501/000-017
	<p>N° art.: 793-501/000-023 Carte de repérage WMB; en carte; non extensible; vierge; encliquetable</p>	www.wago.com/793-501/000-023

	<p>N° art.: 793-501/000-024 Carte de repérage WMB; en carte; non extensible; vierge; encliquetable</p>	<p>www.wago.com/793-501/000-024</p>
	<p>N° art.: 793-502 Carte de repérage WMB; en carte; avec impression; 1 ... 10 (10x); non extensible; Impression horizontale; encliquetable</p>	<p>www.wago.com/793-502</p>
	<p>N° art.: 793-502/000-002 Carte de repérage WMB; en carte; avec impression; 1 ... 10 (10x); non extensible; Impression horizontale; encliquetable</p>	<p>www.wago.com/793-502/000-002</p>
	<p>N° art.: 793-502/000-005 Carte de repérage WMB; en carte; avec impression; 1 ... 10 (10x); non extensible; Impression horizontale; encliquetable</p>	<p>www.wago.com/793-502/000-005</p>
	<p>N° art.: 793-502/000-006 Carte de repérage WMB; en carte; avec impression; 1 ... 10 (10x); non extensible; Impression horizontale; encliquetable</p>	<p>www.wago.com/793-502/000-006</p>
	<p>N° art.: 793-502/000-007 Carte de repérage WMB; en carte; avec impression; 1 ... 10 (10x); non extensible; Impression horizontale; encliquetable</p>	<p>www.wago.com/793-502/000-007</p>
	<p>N° art.: 793-502/000-012 Carte de repérage WMB; en carte; avec impression; 1 ... 10 (10x); non extensible; Impression horizontale; encliquetable</p>	<p>www.wago.com/793-502/000-012</p>
	<p>N° art.: 793-502/000-017 Carte de repérage WMB; en carte; avec impression; 1 ... 10 (10x); non extensible; Impression horizontale; encliquetable</p>	<p>www.wago.com/793-502/000-017</p>
	<p>N° art.: 793-502/000-023 Carte de repérage WMB; en carte; avec impression; 1 ... 10 (10x); non extensible; Impression horizontale; encliquetable</p>	<p>www.wago.com/793-502/000-023</p>
	<p>N° art.: 793-502/000-024 Carte de repérage WMB; en carte; avec impression; 1 ... 10 (10x); non extensible; Impression horizontale; encliquetable</p>	<p>www.wago.com/793-502/000-024</p>
	<p>N° art.: 793-503 Carte de repérage WMB; en carte; avec impression; 11 ... 20 (10x); non extensible; Impression horizontale; encliquetable</p>	<p>www.wago.com/793-503</p>
	<p>N° art.: 793-503/000-002 Carte de repérage WMB; en carte; avec impression; 11 ... 20 (10x); non extensible; Impression horizontale; encliquetable</p>	<p>www.wago.com/793-503/000-002</p>
	<p>N° art.: 793-503/000-005 Carte de repérage WMB; en carte; avec impression; 11 ... 20 (10x); non extensible; Impression horizontale; encliquetable</p>	<p>www.wago.com/793-503/000-005</p>
	<p>N° art.: 793-503/000-006 Carte de repérage WMB; en carte; avec impression; 11 ... 20 (10x); non extensible; Impression horizontale; encliquetable</p>	<p>www.wago.com/793-503/000-006</p>
	<p>N° art.: 793-503/000-007 Carte de repérage WMB; en carte; avec impression; 11 ... 20 (10x); non extensible; Impression horizontale; encliquetable</p>	<p>www.wago.com/793-503/000-007</p>

horizontale; encliquetable



N° art.: 793-503/000-012

Carte de repérage WMB; en carte; avec impression; 11 ... 20 (10x); non extensible; Impression horizontale; encliquetable

www.wago.com/793-503/000-012



N° art.: 793-503/000-017

Carte de repérage WMB; en carte; avec impression; 11 ... 20 (10x); non extensible; Impression horizontale; encliquetable

www.wago.com/793-503/000-017



N° art.: 793-503/000-023

Carte de repérage WMB; en carte; avec impression; 11 ... 20 (10x); non extensible; Impression horizontale; encliquetable

www.wago.com/793-503/000-023



N° art.: 793-503/000-024

Carte de repérage WMB; en carte; avec impression; 11 ... 20 (10x); non extensible; Impression horizontale; encliquetable

www.wago.com/793-503/000-024



N° art.: 793-504

Carte de repérage WMB; en carte; avec impression; 21 ... 30 (10x); non extensible; Impression horizontale; encliquetable

www.wago.com/793-504



N° art.: 793-504/000-002

Carte de repérage WMB; en carte; avec impression; 21 ... 30 (10x); non extensible; Impression horizontale; encliquetable

www.wago.com/793-504/000-002



N° art.: 793-504/000-005

Carte de repérage WMB; en carte; avec impression; 21 ... 30 (10x); non extensible; Impression horizontale; encliquetable

www.wago.com/793-504/000-005



N° art.: 793-504/000-006

Carte de repérage WMB; en carte; avec impression; 21 ... 30 (10x); non extensible; Impression horizontale; encliquetable

www.wago.com/793-504/000-006



N° art.: 793-504/000-012

Carte de repérage WMB; en carte; avec impression; 21 ... 30 (10x); non extensible; Impression horizontale; encliquetable

www.wago.com/793-504/000-012



N° art.: 793-504/000-017

Carte de repérage WMB; en carte; avec impression; 21 ... 30 (10x); non extensible; Impression horizontale; encliquetable

www.wago.com/793-504/000-017



N° art.: 793-504/000-023

Carte de repérage WMB; en carte; avec impression; 21 ... 30 (10x); non extensible; Impression horizontale; encliquetable

www.wago.com/793-504/000-023



N° art.: 793-505

Carte de repérage WMB; en carte; avec impression; 31 ... 40 (10x); non extensible; Impression horizontale; encliquetable

www.wago.com/793-505



N° art.: 793-505/000-005

Carte de repérage WMB; en carte; avec impression; 31 ... 40 (10x); non extensible; Impression horizontale; encliquetable

www.wago.com/793-505/000-005

















N° art.: 793-505/000-006

Carte de repérage WMB; en carte; avec impression; 31 ... 40 (10x); non extensible; Impression horizontale; encliquetable

www.wago.com/793-505/000-006

N° art.: 793-505/000-007

Carte de repérage WMB; en carte; avec impression; 31 ... 40 (10x); non extensible; Impression

	horizontale; encliquetable	www.wago.com/793-505/000-007
	N° art.: 793-505/000-012 Carte de repérage WMB; en carte; avec impression; 31 ... 40 (10x); non extensible; Impression horizontale; encliquetable	www.wago.com/793-505/000-012
	N° art.: 793-506 Carte de repérage WMB; en carte; avec impression; 41 ... 50 (10x); non extensible; Impression horizontale; encliquetable	www.wago.com/793-506
	N° art.: 793-506/000-005 Carte de repérage WMB; en carte; avec impression; 41 ... 50 (10x); non extensible; Impression horizontale; encliquetable	www.wago.com/793-506/000-005
	N° art.: 793-506/000-006 Carte de repérage WMB; en carte; avec impression; 41 ... 50 (10x); non extensible; Impression horizontale; encliquetable	www.wago.com/793-506/000-006
	N° art.: 793-506/000-012 Carte de repérage WMB; en carte; avec impression; 41 ... 50 (10x); non extensible; Impression horizontale; encliquetable	www.wago.com/793-506/000-012
	N° art.: 793-506/000-017 Carte de repérage WMB; en carte; avec impression; 41 ... 50 (10x); non extensible; Impression horizontale; encliquetable	www.wago.com/793-506/000-017
	N° art.: 793-5501 Carte de repérage WMB; en carte; largeur des bornes 5 - 17,5 mm; extensible 5 - 5,2 MM; vierge; encliquetable	www.wago.com/793-5501
	N° art.: 793-5501/000-002 Carte de repérage WMB; en carte; largeur des bornes 5 - 17,5 mm; extensible 5 - 5,2 MM; vierge; encliquetable	www.wago.com/793-5501/000-002
	N° art.: 793-5501/000-005 Carte de repérage WMB; en carte; extensible 5 - 5,2 MM; vierge; encliquetable	www.wago.com/793-5501/000-005
	N° art.: 793-5501/000-006 Carte de repérage WMB; en carte; extensible 5 - 5,2 MM; vierge; encliquetable	www.wago.com/793-5501/000-006
	N° art.: 793-5501/000-007 Carte de repérage WMB; en carte; extensible 5 - 5,2 MM; vierge; encliquetable	www.wago.com/793-5501/000-007
	N° art.: 793-5501/000-012 Carte de repérage WMB; en carte; extensible 5 - 5,2 MM; vierge; encliquetable	www.wago.com/793-5501/000-012
	N° art.: 793-5501/000-014 Carte de repérage WMB; en carte; extensible 5 - 5,2 MM; vierge; encliquetable	www.wago.com/793-5501/000-014
	N° art.: 793-5501/000-017 Carte de repérage WMB; en carte; extensible 5 - 5,2 MM; vierge; encliquetable	www.wago.com/793-5501/000-017



N° art.: 793-5501/000-023
 Carte de repérage WMB; en carte; extensible 5 - 5,2 MM; vierge; encliquetable

www.wago.com/793-5501/000-023



N° art.: 793-5501/000-024
 Carte de repérage WMB; en carte; extensible 5 - 5,2 MM; vierge; encliquetable

www.wago.com/793-5501/000-024



N° art.: 793-566
 Carte de repérage WMB; en carte; avec impression; 1 ... 50 (2x); non extensible; Impression horizontale; encliquetable

www.wago.com/793-566



N° art.: 793-566/000-002
 Carte de repérage WMB; en carte; avec impression; 1 ... 50 (2x); non extensible; Impression horizontale; encliquetable

www.wago.com/793-566/000-002



N° art.: 793-566/000-005
 Carte de repérage WMB; en carte; avec impression; 1 ... 50 (2x); non extensible; Impression horizontale; encliquetable

www.wago.com/793-566/000-005



N° art.: 793-566/000-006
 Carte de repérage WMB; en carte; avec impression; 1 ... 50 (2x); non extensible; Impression horizontale; encliquetable

www.wago.com/793-566/000-006



N° art.: 793-566/000-007
 Carte de repérage WMB; en carte; avec impression; 1 ... 50 (2x); non extensible; Impression horizontale; encliquetable

www.wago.com/793-566/000-007



N° art.: 793-566/000-012
 Carte de repérage WMB; en carte; avec impression; 1 ... 50 (2x); non extensible; Impression horizontale; encliquetable

www.wago.com/793-566/000-012



N° art.: 793-566/000-017
 Carte de repérage WMB; en carte; avec impression; 1 ... 50 (2x); non extensible; Impression horizontale; encliquetable

www.wago.com/793-566/000-017



N° art.: 793-566/000-023
 Carte de repérage WMB; en carte; avec impression; 1 ... 50 (2x); non extensible; Impression horizontale; encliquetable

www.wago.com/793-566/000-023



N° art.: 793-566/000-024
 Carte de repérage WMB; en carte; avec impression; 1 ... 50 (2x); non extensible; Impression horizontale; encliquetable

www.wago.com/793-566/000-024

Téléchargements

Documentation

Bid Text

788-615	Jan 15, 2016	DOC	Téléchargement
Relaisbaustein		28,2 kB	

Instruction Leaflet

Socket with Relay or SSR	Sep 28, 2015	PDF	Téléchargement
--------------------------	--------------	-----	----------------



2,1 MB

Additional Information

Disposal; Electrical and electronic equipment, Packaging

V 1.0.0
Oct 15, 2018

PDF
269,1 kB

Téléchargement

smartDATA

CAD data

3D Download 788-615

URL

Téléchargement

Sous réserve de modifications.