

Fiche technique | Numéro d'article: 788-346

Module relais; Tension nominale d'entrée DC 24 V; 2 RT; Limitation courant constant 8 A; avec forçage manuel; Indication d'état rouge; Largeur 15 mm

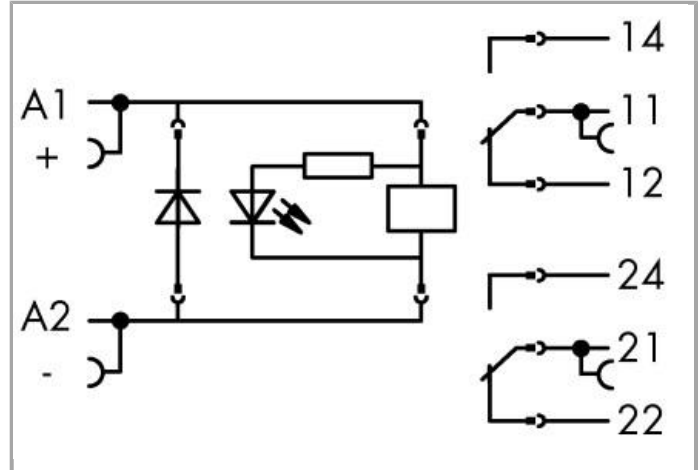

[www.wago.com/788-346](http://www.wago.com/788-346)

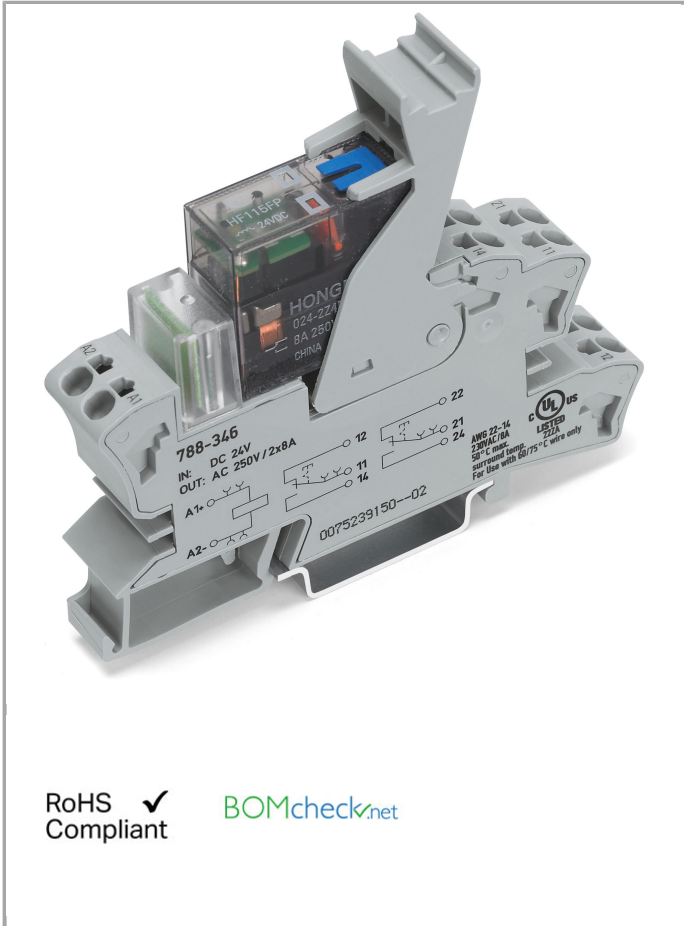

RoHS  Compliant [BOMcheck.net](http://BOMcheck.net)

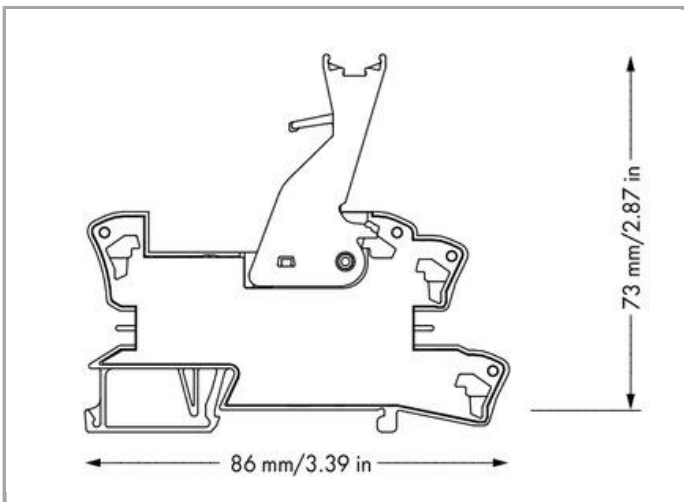

Description du produit :

**Note:****Remarques :**

- Isolation renforcée entre bobine et contacts
- Pour des tensions supérieures à 250 V entre modules relais connectés et pour respecter l'isolation renforcée, il faut utiliser un séparateur (par ex. 209-191).
- Un dispositif d'antiparasitage approprié doit être installé parallèlement aux charges inductives.

**Données****Données techniques****Circuit de commande**

Nominal input voltage $U_N$	24 VDC
Input voltage range	±10 %
Courant d'entrée nominal $I_N$	16.7 mA

**Circuit de charge**

Nombre relais 1 T/contacts inverseurs	2
Contact material (relay)	AgNi
Limiting continuous current	8 A
Max. make current (resistive)	12 A (AC)
Max. switching voltage	250 VAC
Max. switching power (resistive)	2000 VAAC; DC see load limit curve
Switching capacity	AC-15: 1,5 A / 240 VAC; DC-13: 1 A / 24 VDC
Charge min. recommandée	12 V / 10 mA
Temps de montée typ.	15 ms
Temps de relâchement	8 ms
Temps de rebondissement (typ.)	7 ms
Electrical life (N.O.; resistive load; 23 °C)	$10 \times 10^3$ switching operations
Mechanical life (N.O.; resistive load; 23 °C)	$5 \times 10^6$ switching operations
Max. switching load with load/without load	$6 \text{ min}^{-1} / 300 \text{ min}^{-1}$

**Signaling**

Indication d'état	LED red Mechanical
-------------------	-----------------------

**Sécurité & Protection**

Tension de référence	250 V
Tension assignée de tenue aux chocs	4 kV

Degré de pollution	3
Tension de claquage contact-bobine (AC, 1 min.)	5 kV <sub>rms</sub>
Dielectric strength, control/load circuit (AC, 1 min)	5 kV <sub>rms</sub>
Tension de claquage contact ouvert (AC, 1 min)	1 kV <sub>rms</sub>
Dielectric strength open contact (AC, 1 min)	1 kV <sub>rms</sub>
Tension de claquage, contact adjacent (AC, 1 min)	2.5 kV <sub>rms</sub>
Dielectric strength, load/load circuit (AC, 1 min)	2,5 kV <sub>rms</sub>
Indice de protection	IP20

### Données de raccordement

Technique de connexion	Push-in CAGE CLAMP®
Conducteur rigide	0,34 ... 2,5 mm <sup>2</sup> / 22 ... 14 AWG
Conducteur souple	0,34 ... 2,5 mm <sup>2</sup> / 22 ... 14 AWG
Longueur de dénudage	9 ... 10 mm / 0.35 ... 0.39 inch

### Données géométriques

Largeur	15 mm / 0.591 inch
Profondeur à partir du niveau supérieur du rail	73 mm / 2.874 inch
Profondeur	86 mm / 3.386 inch

### Données mécaniques

Type de montage	Rail 35
-----------------	---------

### Données du matériau

Poids	34.608 g
-------	----------

### Conditions d'environnement

Température ambiante admissible Fonctionnement pour U <sub>N</sub>	-40 ... 70 °C
Température ambiante (stockage)	-40 ... 70 °C
Degré de pollution	3

### Normes et spécifications

Normes/spécifications	EN 61010-2-201; EN 61810-1; EN 61373; UL 508
-----------------------	--

### Elementary relay

WAGO elementary relay	788-936
-----------------------	---------

## Dates commerciales

Country of origin	DE
GTIN	4050821226864
Customs Tariff No.	85364900990
Product Group	6 (Interface Electronics)

## Autorisations / certificats

### Approbations UL

Logo	Approbation	Nom du certificat
	UL UL International Netherlands B.V. (ORDINARY LOCATIONS)	E175199 Sec.6

## Produits correspondants





### tools

	<b>N° art.: 210-720</b> Outil de manipulation, partiellement isolé; Type 2, lame (3,5 x 0,5) mm	<a href="http://www.wago.com/210-720">www.wago.com/210-720</a>
--	--	--





### General accessories

	<b>N° art.: 209-145</b> Porte-étiquettes de groupe	<a href="http://www.wago.com/209-145">www.wago.com/209-145</a>
	<b>N° art.: 209-184</b> Protège-étiquettes	<a href="http://www.wago.com/209-184">www.wago.com/209-184</a>
	<b>N° art.: 249-105</b> Porte-étiquettes de groupe	<a href="http://www.wago.com/249-105">www.wago.com/249-105</a>
	<b>N° art.: 788-120</b> Accessoire pour module relais; Etat de fonctionnement rouge	<a href="http://www.wago.com/788-120">www.wago.com/788-120</a>











### ferrule

	<b>N° art.: 216-241</b> Embout d'extrémité; embout pour 0,5 mm <sup>2</sup> / AWG 22; avec isolation plastique; étamés par électrolyse; Cuivre électrolytique; serti de manière étanche aux gaz; selon DIN 46228, partie 4/09.90	<a href="http://www.wago.com/216-241">www.wago.com/216-241</a>
	<b>N° art.: 216-242</b> Embout d'extrémité; embout pour 0,75 mm <sup>2</sup> / AWG 20; avec isolation plastique; étamés par électrolyse; Cuivre électrolytique; serti de manière étanche aux gaz; selon DIN 46228, partie 4/09.90	<a href="http://www.wago.com/216-242">www.wago.com/216-242</a>
	<b>N° art.: 216-243</b> Embout d'extrémité; embout pour 1 mm <sup>2</sup> / AWG 18; avec isolation plastique; étamés par électrolyse; Cuivre électrolytique; serti de manière étanche aux gaz; selon DIN 46228, partie 4/09.90	<a href="http://www.wago.com/216-243">www.wago.com/216-243</a>
	<b>N° art.: 216-244</b> Embout d'extrémité; embout pour 1,5 mm <sup>2</sup> / AWG 16; avec isolation plastique; étamés par électrolyse; Cuivre électrolytique; serti de manière étanche aux gaz; selon DIN 46228, partie 4/09.90	<a href="http://www.wago.com/216-244">www.wago.com/216-244</a>
	<b>N° art.: 216-542</b> Embout d'extrémité double; Embout pour 2 x 1 mm <sup>2</sup> / AWG 2 x 18; rouge, isolé; longueur 12 mm	<a href="http://www.wago.com/216-542">www.wago.com/216-542</a>

## Jumper

	<b>N° art.: 788-118</b> Peigne de pontage; 2 pôles (1-3); isolé	<a href="http://www.wago.com/788-118">www.wago.com/788-118</a>
	<b>N° art.: 859-402</b> Peigne de pontage; 2 raccords; Courant nominal 18 A; isolé	<a href="http://www.wago.com/859-402">www.wago.com/859-402</a>
	<b>N° art.: 859-402/000-005</b> Peigne de pontage; 2 raccords; Courant nominal 18 A; isolé	<a href="http://www.wago.com/859-402/000-005">www.wago.com/859-402/000-005</a>
	<b>N° art.: 859-402/000-006</b> Peigne de pontage; 2 raccords; Courant nominal 18 A; isolé	<a href="http://www.wago.com/859-402/000-006">www.wago.com/859-402/000-006</a>
	<b>N° art.: 859-402/000-029</b> Peigne de pontage; 2 raccords; Courant nominal 18 A; isolé	<a href="http://www.wago.com/859-402/000-029">www.wago.com/859-402/000-029</a>

## Marking accessories

	<b>N° art.: 2009-110</b> Bandes de marquage; sur rouleau; non extensible; vierge; encliquetable	<a href="http://www.wago.com/2009-110">www.wago.com/2009-110</a>
	<b>N° art.: 2009-115</b> WMB-Inline; pour smartPRINTER; sur rouleau; extensible 5 - 5,2 MM; vierge; encliquetable	<a href="http://www.wago.com/2009-115">www.wago.com/2009-115</a>
	<b>N° art.: 2009-115/000-002</b> WMB-Inline; pour smartPRINTER; sur rouleau; extensible 5 - 5,2 MM; vierge; encliquetable	<a href="http://www.wago.com/2009-115/000-002">www.wago.com/2009-115/000-002</a>
	<b>N° art.: 2009-115/000-006</b> WMB-Inline; pour smartPRINTER; sur rouleau; extensible 5 - 5,2 MM; vierge; encliquetable	<a href="http://www.wago.com/2009-115/000-006">www.wago.com/2009-115/000-006</a>
	<b>N° art.: 2009-115/000-007</b> WMB-Inline; sur rouleau; extensible 5 - 5,2 MM; vierge; encliquetable	<a href="http://www.wago.com/2009-115/000-007">www.wago.com/2009-115/000-007</a>
	<b>N° art.: 2009-115/000-012</b> WMB-Inline; pour smartPRINTER; sur rouleau; extensible 5 - 5,2 MM; vierge; encliquetable	<a href="http://www.wago.com/2009-115/000-012">www.wago.com/2009-115/000-012</a>
	<b>N° art.: 2009-115/000-017</b> WMB-Inline; sur rouleau; extensible 5 - 5,2 MM; vierge; encliquetable	<a href="http://www.wago.com/2009-115/000-017">www.wago.com/2009-115/000-017</a>
	<b>N° art.: 2009-115/000-023</b> WMB-Inline; pour smartPRINTER; sur rouleau; extensible 5 - 5,2 MM; vierge; encliquetable	<a href="http://www.wago.com/2009-115/000-023">www.wago.com/2009-115/000-023</a>
	<b>N° art.: 209-128</b> Adaptateur	<a href="http://www.wago.com/209-128">www.wago.com/209-128</a>
	<b>N° art.: 209-183</b> Étiquette à enficher	<a href="http://www.wago.com/209-183">www.wago.com/209-183</a>
	<b>N° art.: 210-110</b>	



Stylo feutre-graveur

[www.wago.com/210-110](http://www.wago.com/210-110)



**N° art.: 793-501**  
Carte de repérage WMB; en carte; non extensible; vierge; encliquetable

[www.wago.com/793-501](http://www.wago.com/793-501)



**N° art.: 793-501/000-002**  
Carte de repérage WMB; en carte; non extensible; vierge; encliquetable

[www.wago.com/793-501/000-002](http://www.wago.com/793-501/000-002)



**N° art.: 793-501/000-005**  
Carte de repérage WMB; en carte; non extensible; vierge; encliquetable

[www.wago.com/793-501/000-005](http://www.wago.com/793-501/000-005)



**N° art.: 793-501/000-006**  
Carte de repérage WMB; en carte; non extensible; vierge; encliquetable

[www.wago.com/793-501/000-006](http://www.wago.com/793-501/000-006)



**N° art.: 793-501/000-007**  
Carte de repérage WMB; en carte; non extensible; vierge; encliquetable

[www.wago.com/793-501/000-007](http://www.wago.com/793-501/000-007)



**N° art.: 793-501/000-012**  
Carte de repérage WMB; en carte; non extensible; vierge; encliquetable

[www.wago.com/793-501/000-012](http://www.wago.com/793-501/000-012)



**N° art.: 793-501/000-017**  
Carte de repérage WMB; en carte; non extensible; vierge; encliquetable

[www.wago.com/793-501/000-017](http://www.wago.com/793-501/000-017)



**N° art.: 793-501/000-023**  
Carte de repérage WMB; en carte; non extensible; vierge; encliquetable

[www.wago.com/793-501/000-023](http://www.wago.com/793-501/000-023)



**N° art.: 793-501/000-024**  
Carte de repérage WMB; en carte; non extensible; vierge; encliquetable

[www.wago.com/793-501/000-024](http://www.wago.com/793-501/000-024)



**N° art.: 793-502**  
Carte de repérage WMB; en carte; avec impression; 1 ... 10 (10x); non extensible; Impression horizontale; encliquetable

[www.wago.com/793-502](http://www.wago.com/793-502)



**N° art.: 793-502/000-002**  
Carte de repérage WMB; en carte; avec impression; 1 ... 10 (10x); non extensible; Impression horizontale; encliquetable

[www.wago.com/793-502/000-002](http://www.wago.com/793-502/000-002)



**N° art.: 793-502/000-005**  
Carte de repérage WMB; en carte; avec impression; 1 ... 10 (10x); non extensible; Impression horizontale; encliquetable

[www.wago.com/793-502/000-005](http://www.wago.com/793-502/000-005)



**N° art.: 793-502/000-006**  
Carte de repérage WMB; en carte; avec impression; 1 ... 10 (10x); non extensible; Impression horizontale; encliquetable

[www.wago.com/793-502/000-006](http://www.wago.com/793-502/000-006)



**N° art.: 793-502/000-007**  
Carte de repérage WMB; en carte; avec impression; 1 ... 10 (10x); non extensible; Impression horizontale; encliquetable

[www.wago.com/793-502/000-007](http://www.wago.com/793-502/000-007)

**N° art.: 793-502/000-012**



Carte de repérage WMB; en carte; avec impression; 1 ... 10 (10x); non extensible; Impression horizontale; encliquetable

[www.wago.com/793-502/000-012](http://www.wago.com/793-502/000-012)



**N° art.: 793-502/000-017**

Carte de repérage WMB; en carte; avec impression; 1 ... 10 (10x); non extensible; Impression horizontale; encliquetable

[www.wago.com/793-502/000-017](http://www.wago.com/793-502/000-017)



**N° art.: 793-502/000-023**

Carte de repérage WMB; en carte; avec impression; 1 ... 10 (10x); non extensible; Impression horizontale; encliquetable

[www.wago.com/793-502/000-023](http://www.wago.com/793-502/000-023)



**N° art.: 793-502/000-024**

Carte de repérage WMB; en carte; avec impression; 1 ... 10 (10x); non extensible; Impression horizontale; encliquetable

[www.wago.com/793-502/000-024](http://www.wago.com/793-502/000-024)



**N° art.: 793-503**

Carte de repérage WMB; en carte; avec impression; 11 ... 20 (10x); non extensible; Impression horizontale; encliquetable

[www.wago.com/793-503](http://www.wago.com/793-503)



**N° art.: 793-503/000-002**

Carte de repérage WMB; en carte; avec impression; 11 ... 20 (10x); non extensible; Impression horizontale; encliquetable

[www.wago.com/793-503/000-002](http://www.wago.com/793-503/000-002)



**N° art.: 793-503/000-005**

Carte de repérage WMB; en carte; avec impression; 11 ... 20 (10x); non extensible; Impression horizontale; encliquetable

[www.wago.com/793-503/000-005](http://www.wago.com/793-503/000-005)



**N° art.: 793-503/000-006**

Carte de repérage WMB; en carte; avec impression; 11 ... 20 (10x); non extensible; Impression horizontale; encliquetable

[www.wago.com/793-503/000-006](http://www.wago.com/793-503/000-006)



**N° art.: 793-503/000-007**

Carte de repérage WMB; en carte; avec impression; 11 ... 20 (10x); non extensible; Impression horizontale; encliquetable

[www.wago.com/793-503/000-007](http://www.wago.com/793-503/000-007)



**N° art.: 793-503/000-012**

Carte de repérage WMB; en carte; avec impression; 11 ... 20 (10x); non extensible; Impression horizontale; encliquetable

[www.wago.com/793-503/000-012](http://www.wago.com/793-503/000-012)



**N° art.: 793-503/000-017**

Carte de repérage WMB; en carte; avec impression; 11 ... 20 (10x); non extensible; Impression horizontale; encliquetable

[www.wago.com/793-503/000-017](http://www.wago.com/793-503/000-017)



**N° art.: 793-503/000-023**

Carte de repérage WMB; en carte; avec impression; 11 ... 20 (10x); non extensible; Impression horizontale; encliquetable

[www.wago.com/793-503/000-023](http://www.wago.com/793-503/000-023)



**N° art.: 793-503/000-024**

Carte de repérage WMB; en carte; avec impression; 11 ... 20 (10x); non extensible; Impression horizontale; encliquetable

[www.wago.com/793-503/000-024](http://www.wago.com/793-503/000-024)



**N° art.: 793-504**

Carte de repérage WMB; en carte; avec impression; 21 ... 30 (10x); non extensible; Impression horizontale; encliquetable















[www.wago.com/793-504](http://www.wago.com/793-504)

















**N° art.: 793-504/000-002**

Carte de repérage WMB; en carte; avec impression; 21 ... 30 (10x); non extensible; Impression horizontale; encliquetable

[www.wago.com/793-504/000-002](http://www.wago.com/793-504/000-002)

	<p><b>N° art.: 793-504/000-005</b>                  Carte de repérage WMB; en carte; avec impression; 21 ... 30 (10x); non extensible; Impression horizontale; encliquetable</p>	<a href="http://www.wago.com/793-504/000-005">www.wago.com/793-504/000-005</a>
	<p><b>N° art.: 793-504/000-006</b>                  Carte de repérage WMB; en carte; avec impression; 21 ... 30 (10x); non extensible; Impression horizontale; encliquetable</p>	<a href="http://www.wago.com/793-504/000-006">www.wago.com/793-504/000-006</a>
	<p><b>N° art.: 793-504/000-012</b>                  Carte de repérage WMB; en carte; avec impression; 21 ... 30 (10x); non extensible; Impression horizontale; encliquetable</p>	<a href="http://www.wago.com/793-504/000-012">www.wago.com/793-504/000-012</a>
	<p><b>N° art.: 793-504/000-017</b>                  Carte de repérage WMB; en carte; avec impression; 21 ... 30 (10x); non extensible; Impression horizontale; encliquetable</p>	<a href="http://www.wago.com/793-504/000-017">www.wago.com/793-504/000-017</a>
	<p><b>N° art.: 793-504/000-023</b>                  Carte de repérage WMB; en carte; avec impression; 21 ... 30 (10x); non extensible; Impression horizontale; encliquetable</p>	<a href="http://www.wago.com/793-504/000-023">www.wago.com/793-504/000-023</a>
	<p><b>N° art.: 793-505</b>                  Carte de repérage WMB; en carte; avec impression; 31 ... 40 (10x); non extensible; Impression horizontale; encliquetable</p>	<a href="http://www.wago.com/793-505">www.wago.com/793-505</a>
	<p><b>N° art.: 793-505/000-005</b>                  Carte de repérage WMB; en carte; avec impression; 31 ... 40 (10x); non extensible; Impression horizontale; encliquetable</p>	<a href="http://www.wago.com/793-505/000-005">www.wago.com/793-505/000-005</a>
	<p><b>N° art.: 793-505/000-006</b>                  Carte de repérage WMB; en carte; avec impression; 31 ... 40 (10x); non extensible; Impression horizontale; encliquetable</p>	<a href="http://www.wago.com/793-505/000-006">www.wago.com/793-505/000-006</a>
	<p><b>N° art.: 793-505/000-007</b>                  Carte de repérage WMB; en carte; avec impression; 31 ... 40 (10x); non extensible; Impression horizontale; encliquetable</p>	<a href="http://www.wago.com/793-505/000-007">www.wago.com/793-505/000-007</a>
	<p><b>N° art.: 793-505/000-012</b>                  Carte de repérage WMB; en carte; avec impression; 31 ... 40 (10x); non extensible; Impression horizontale; encliquetable</p>	<a href="http://www.wago.com/793-505/000-012">www.wago.com/793-505/000-012</a>
	<p><b>N° art.: 793-506</b>                  Carte de repérage WMB; en carte; avec impression; 41 ... 50 (10x); non extensible; Impression horizontale; encliquetable</p>	<a href="http://www.wago.com/793-506">www.wago.com/793-506</a>
	<p><b>N° art.: 793-506/000-005</b>                  Carte de repérage WMB; en carte; avec impression; 41 ... 50 (10x); non extensible; Impression horizontale; encliquetable</p>	<a href="http://www.wago.com/793-506/000-005">www.wago.com/793-506/000-005</a>
	<p><b>N° art.: 793-506/000-006</b>                  Carte de repérage WMB; en carte; avec impression; 41 ... 50 (10x); non extensible; Impression horizontale; encliquetable</p>	<a href="http://www.wago.com/793-506/000-006">www.wago.com/793-506/000-006</a>
	<p><b>N° art.: 793-506/000-012</b>                  Carte de repérage WMB; en carte; avec impression; 41 ... 50 (10x); non extensible; Impression horizontale; encliquetable</p>	<a href="http://www.wago.com/793-506/000-012">www.wago.com/793-506/000-012</a>
	<p><b>N° art.: 793-506/000-017</b>                  Carte de repérage WMB; en carte; avec impression; 41 ... 50 (10x); non extensible; Impression horizontale; encliquetable</p>	<a href="http://www.wago.com/793-506/000-017">www.wago.com/793-506/000-017</a>



	<p><b>N° art.: 793-5501</b>                      Carte de repérage WMB; en carte; largeur des bornes 5 - 17,5 mm; extensible 5 - 5,2 MM; vierge; encliquetable</p>	<a href="http://www.wago.com/793-5501">www.wago.com/793-5501</a>
	<p><b>N° art.: 793-5501/000-002</b>                      Carte de repérage WMB; en carte; largeur des bornes 5 - 17,5 mm; extensible 5 - 5,2 MM; vierge; encliquetable</p>	<a href="http://www.wago.com/793-5501/000-002">www.wago.com/793-5501/000-002</a>
	<p><b>N° art.: 793-5501/000-005</b>                      Carte de repérage WMB; en carte; extensible 5 - 5,2 MM; vierge; encliquetable</p>	<a href="http://www.wago.com/793-5501/000-005">www.wago.com/793-5501/000-005</a>
	<p><b>N° art.: 793-5501/000-006</b>                      Carte de repérage WMB; en carte; extensible 5 - 5,2 MM; vierge; encliquetable</p>	<a href="http://www.wago.com/793-5501/000-006">www.wago.com/793-5501/000-006</a>
	<p><b>N° art.: 793-5501/000-007</b>                      Carte de repérage WMB; en carte; extensible 5 - 5,2 MM; vierge; encliquetable</p>	<a href="http://www.wago.com/793-5501/000-007">www.wago.com/793-5501/000-007</a>
	<p><b>N° art.: 793-5501/000-012</b>                      Carte de repérage WMB; en carte; extensible 5 - 5,2 MM; vierge; encliquetable</p>	<a href="http://www.wago.com/793-5501/000-012">www.wago.com/793-5501/000-012</a>
	<p><b>N° art.: 793-5501/000-014</b>                      Carte de repérage WMB; en carte; extensible 5 - 5,2 MM; vierge; encliquetable</p>	<a href="http://www.wago.com/793-5501/000-014">www.wago.com/793-5501/000-014</a>
	<p><b>N° art.: 793-5501/000-017</b>                      Carte de repérage WMB; en carte; extensible 5 - 5,2 MM; vierge; encliquetable</p>	<a href="http://www.wago.com/793-5501/000-017">www.wago.com/793-5501/000-017</a>
	<p><b>N° art.: 793-5501/000-023</b>                      Carte de repérage WMB; en carte; extensible 5 - 5,2 MM; vierge; encliquetable</p>	<a href="http://www.wago.com/793-5501/000-023">www.wago.com/793-5501/000-023</a>
	<p><b>N° art.: 793-5501/000-024</b>                      Carte de repérage WMB; en carte; extensible 5 - 5,2 MM; vierge; encliquetable</p>	<a href="http://www.wago.com/793-5501/000-024">www.wago.com/793-5501/000-024</a>
	<p><b>N° art.: 793-566</b>                      Carte de repérage WMB; en carte; avec impression; 1 ... 50 (2x); non extensible; Impression horizontale; encliquetable</p>	<a href="http://www.wago.com/793-566">www.wago.com/793-566</a>
	<p><b>N° art.: 793-566/000-002</b>                      Carte de repérage WMB; en carte; avec impression; 1 ... 50 (2x); non extensible; Impression horizontale; encliquetable</p>	<a href="http://www.wago.com/793-566/000-002">www.wago.com/793-566/000-002</a>
	<p><b>N° art.: 793-566/000-005</b>                      Carte de repérage WMB; en carte; avec impression; 1 ... 50 (2x); non extensible; Impression horizontale; encliquetable</p>	<a href="http://www.wago.com/793-566/000-005">www.wago.com/793-566/000-005</a>
	<p><b>N° art.: 793-566/000-006</b>                      Carte de repérage WMB; en carte; avec impression; 1 ... 50 (2x); non extensible; Impression horizontale; encliquetable</p>	<a href="http://www.wago.com/793-566/000-006">www.wago.com/793-566/000-006</a>
	<p><b>N° art.: 793-566/000-007</b>                      Carte de repérage WMB; en carte; avec impression; 1 ... 50 (2x); non extensible; Impression horizontale; encliquetable</p>	<a href="http://www.wago.com/793-566/000-007">www.wago.com/793-566/000-007</a>



N° art.: 793-566/000-012

Carte de repérage WMB; en carte; avec impression; 1 ... 50 (2x); non extensible; Impression horizontale; encliquetable

[www.wago.com/793-566/000-012](http://www.wago.com/793-566/000-012)



N° art.: 793-566/000-017

Carte de repérage WMB; en carte; avec impression; 1 ... 50 (2x); non extensible; Impression horizontale; encliquetable

[www.wago.com/793-566/000-017](http://www.wago.com/793-566/000-017)



N° art.: 793-566/000-023

Carte de repérage WMB; en carte; avec impression; 1 ... 50 (2x); non extensible; Impression horizontale; encliquetable

[www.wago.com/793-566/000-023](http://www.wago.com/793-566/000-023)



N° art.: 793-566/000-024

Carte de repérage WMB; en carte; avec impression; 1 ... 50 (2x); non extensible; Impression horizontale; encliquetable

[www.wago.com/793-566/000-024](http://www.wago.com/793-566/000-024)

## Téléchargements

### Documentation

#### Bid Text

788-346	Jan 15, 2016	DOC	Téléchargement
Relaisbaustein		28,7 kB	

#### Instruction Leaflet

Socket with Relay or SSR	Sep 28, 2015	PDF	Téléchargement
		2,1 MB	

#### Additional Information

Disposal; Electrical and electronic equipment, Packaging	V 1.0.0	PDF	Téléchargement
	Oct 15, 2018	269,1 kB	

## smartDATA

### CAD data

3D Download 788-346	URL	Téléchargement
---------------------	-----	----------------

Sous réserve de modifications.

WAGO Contact SAS  
Paris Nord 2 - 83 rue des Chardonnerets  
Tremblay-en-France  
BP 55065  
95947 Roissy CDG Cedex  
Téléphone : 01 48 17 25 90 | Fax : 01 48 63 25 20  
E-mail : [info-fr@wago.com](mailto:info-fr@wago.com) | Web : [www.wago.fr](http://www.wago.fr)

Avez-vous des questions sur nos produits ?  
Nous nous tenons volontiers à votre disposition au +49 (571) 887-44222.