

Fiche technique | Numéro d'article: 857-303

Module relais; Tension nominale d'entrée DC 12 V; 1 RT; Limitation courant constant 6 A; Indication d'état des capteurs/actionneurs jaune; Largeur 6 mm

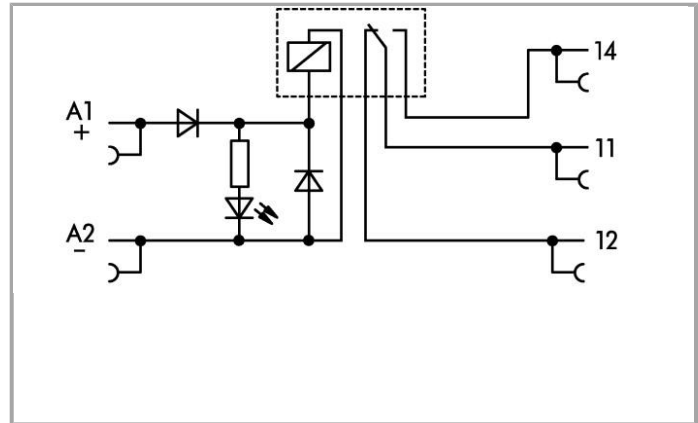

www.wago.com/857-303

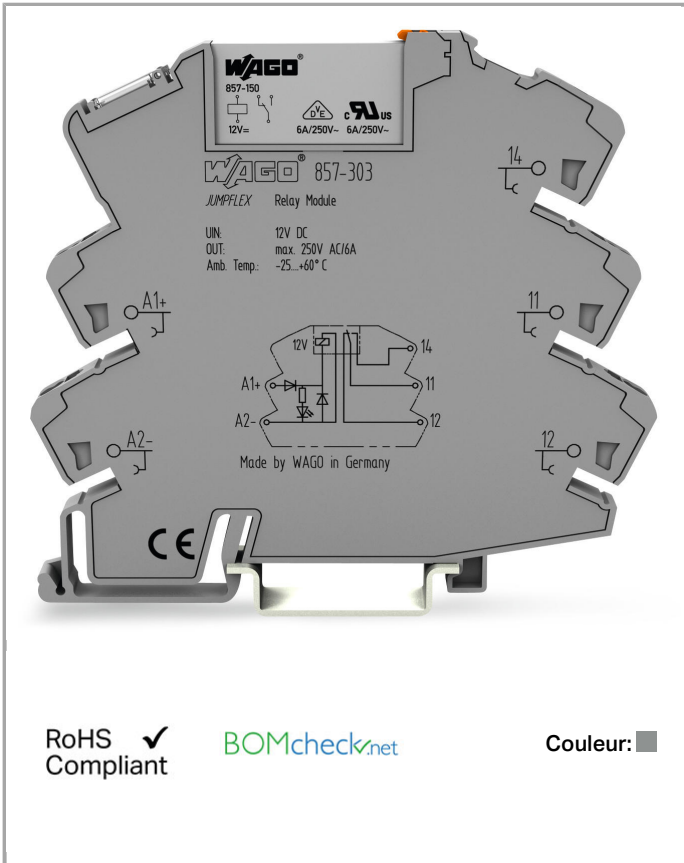

RoHS Compliant

BOMcheck.net

Couleur: ■

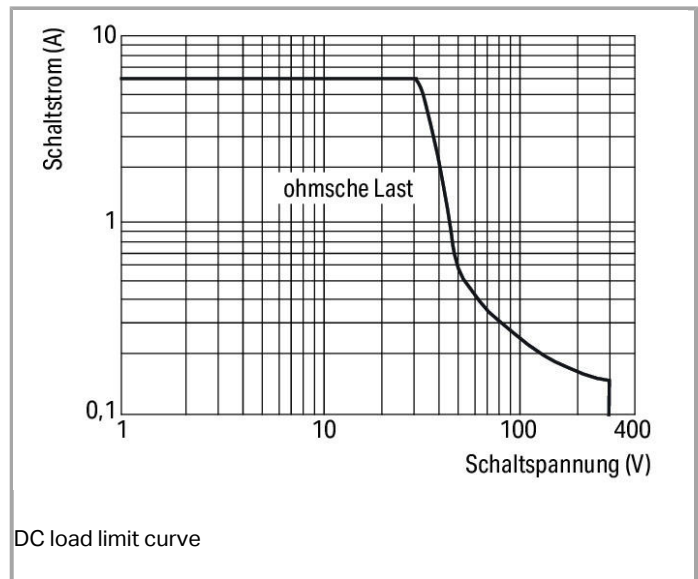
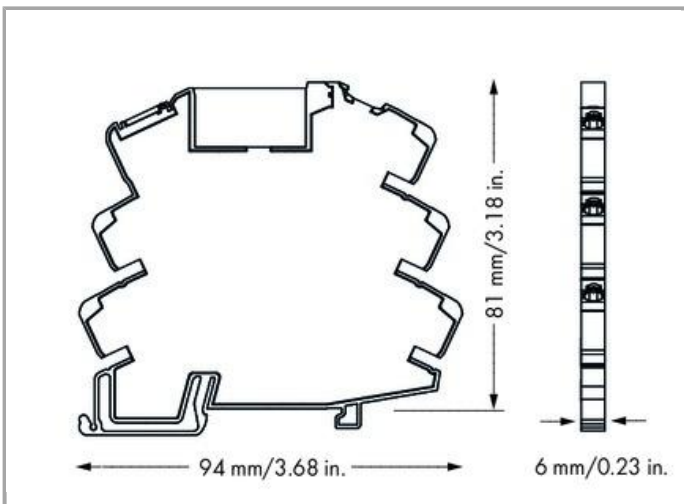

DC load limit curve

Description du produit :

Brève description :

Module relais avec relais miniature remplaçable pour la séparation galvanique entre les capteurs/actionneurs et la commande / API.

Les modules relais WAGO d'un pas de 6 mm ont un profil absolument identique. En outre, les dispositifs de pontage pour les tensions d'alimentation, etc. se trouvent toujours à la même position, il suffit alors d'utiliser les peignes de pontage pour une simplification du câblage. Si besoin, les relais enfichables peuvent être remplacés rapidement et simplement. En option, un adaptateur de câblage peut être enfiché en entrée ou sortie pour la connexion rapide sans risque d'erreur de 8 modules. Celui-ci permet le précâblage de 8 modules via un cordon câble plat.

L'état de commutation est indiqué par une LED jaune intégrée.

Le repérage des équipements peut être réalisé à l'aide du système de marquage multiple WMB de WAGO.

Note:

Remarque : Un dispositif d'antiparasitage approprié doit être installé parallèlement aux charges inductives.

Données**Données techniques****Circuit de commande**

Nominal input voltage U_N	12 VDC
Input voltage range	-15 ... +20 %
Courant d'entrée nominal IN	17 mA

Circuit de charge

Nombre relais 1 T/contacts inverseurs	1
Contact material (relay)	AgSnO ₂
Limiting continuous current	6 A
Max. make current (resistive)	0,02 s 20 A (AC)
Max. switching voltage	250 VAC
Max. switching power (resistive)	1500 VAAC; DC see load limit curve
Switching capacity	AC-15: 3 A / 250 VAC; DC-13: 2 A / 24 VDC
Charge min. recommandée	10 V / 10 mA; 24 V / 1 mA
Temps de montée typ.	8 ms
Temps de relâchement	4 ms
Electrical life (N.O.; resistive load; 23 °C)	50 x 10 ³ switching operations
Mechanical life (N.O.; resistive load; 23 °C)	5 x 10 ⁶ switching operations
Max. switching load with load/without load	6 min ⁻¹ / 180 min ⁻¹

Signaling

Indication d'état	LED jaune
-------------------	-----------

Sécurité & Protection

Tension de référence	250 V
Tension assignée de tenue aux chocs	4 kV
Degré de pollution	2
Tension de claquage contact-bobine (AC, 1 min.)	4 kV _{rms}
Dielectric strength, control/load circuit (AC, 1 min)	4 kV _{rms}
Tension de claquage contact ouvert (AC, 1 min)	1 kV _{rms}
Dielectric strength open contact (AC, 1 min)	1 kV _{rms}
Indice de protection	IP20

Données de raccordement

Technique de connexion	Push-in CAGE CLAMP®
Conducteur rigide	0,34 ... 2,5 mm ² / 22 ... 14 AWG
Conducteur souple	0,34 ... 2,5 mm ² / 22 ... 14 AWG
Longueur de dénudage	9 ... 10 mm / 0.35 ... 0.39 inch

Données géométriques

Largeur	6 mm / 0.236 inch
Profondeur à partir du niveau supérieur du rail	81 mm / 3.189 inch
Profondeur	94 mm / 3.701 inch

Données mécaniques

Type de montage	Rail 35
-----------------	---------

Données du matériau

Couleur	gris
Charge calorifique	0.481 MJ
Poids	30.6 g

Conditions d'environnement

Température ambiante admissible Fonctionnement pour U _N	-40 ... 60 °C
Température ambiante (stockage)	-40 ... 70 °C
Processing temperature	-25 ... +50 °C
Degré de pollution	2

Normes et spécifications

Normes/spécifications	EN 61010-2-201; EN 61810-1; EN 61373; UL 508; ATEX, IEC Ex
-----------------------	--

Elementary relay



WAGO elementary relay	857-150
-----------------------	---------

Dates commerciales

Country of origin	CN
GTIN	4055143135207
Customs Tariff No.	85364900990
Product Group	6 (Interface Electronics)

Autorisations / certificats

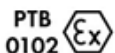
Ex-approbations



Logo	Approbation	Nom du certificat
	ATEX DEKRA EXAM GmbH	BVS_14_ATEX_E_091_X
	IECEX DEKRA EXAM GmbH	IECEX_BVS_14.0079_X
	UL UL International Germany GmbH (HAZARDOUS LOCATIONS)	E198726 Sec.4 (HAZARDOUS LOCATIONS)

Approbations UL

Logo	Approbation	Nom du certificat
	UL UL International Netherlands B.V. (ORDINARY LOCATIONS)	E175199 Sec.4 (ORDINARY LOCATIONS)

Produits correspondants

General accessories

	N° art.: 209-184 Protège-étiquettes	www.wago.com/209-184
	N° art.: 249-105 Porte-étiquettes de groupe	www.wago.com/249-105
	N° art.: 857-150 Relais de couplage; Tension nominale d'entrée DC 12 V; 1 RT; Limitation courant constant 6 A; Largeur 5 mm; Hauteur du relais 15 mm	www.wago.com/857-150

tools



N° art.: 210-720

Outil de manipulation, partiellement isolé; Type 2, lame (3,5 x 0,5) mm

www.wago.com/210-720

Marking accessories



N° art.: 2009-110

Bandes de marquage; sur rouleau; non extensible; vierge; encliquetable

www.wago.com/2009-110

N° art.: 2009-115

WMB-Inline; pour smartPRINTER; sur rouleau; extensible 5 - 5,2 MM; vierge; encliquetable

www.wago.com/2009-115

N° art.: 2009-115/000-002

WMB-Inline; pour smartPRINTER; sur rouleau; extensible 5 - 5,2 MM; vierge; encliquetable

www.wago.com/2009-115/000-002

N° art.: 2009-115/000-006

WMB-Inline; pour smartPRINTER; sur rouleau; extensible 5 - 5,2 MM; vierge; encliquetable

www.wago.com/2009-115/000-006

N° art.: 2009-115/000-007

WMB-Inline; sur rouleau; extensible 5 - 5,2 MM; vierge; encliquetable

www.wago.com/2009-115/000-007

N° art.: 2009-115/000-012

WMB-Inline; pour smartPRINTER; sur rouleau; extensible 5 - 5,2 MM; vierge; encliquetable

www.wago.com/2009-115/000-012

N° art.: 2009-115/000-017

WMB-Inline; sur rouleau; extensible 5 - 5,2 MM; vierge; encliquetable

www.wago.com/2009-115/000-017

N° art.: 2009-115/000-023

WMB-Inline; pour smartPRINTER; sur rouleau; extensible 5 - 5,2 MM; vierge; encliquetable

www.wago.com/2009-115/000-023

N° art.: 2009-115/000-024

WMB-Inline; pour smartPRINTER; sur rouleau; extensible 5 - 5,2 MM; vierge; encliquetable

www.wago.com/2009-115/000-024

N° art.: 209-128

Adaptateur

www.wago.com/209-128

N° art.: 209-183

Étiquette à enficher

www.wago.com/209-183

N° art.: 210-110

Stylo feutre-graveur

www.wago.com/210-110

N° art.: 793-501

Carte de repérage WMB; en carte; non extensible; vierge; encliquetable

www.wago.com/793-501

N° art.: 793-501/000-002

Carte de repérage WMB; en carte; non extensible; vierge; encliquetable

www.wago.com/793-501/000-002



N° art.: 793-501/000-005
Carte de repérage WMB; en carte; non extensible; vierge; encliquetable

www.wago.com/793-501/000-005



N° art.: 793-501/000-006
Carte de repérage WMB; en carte; non extensible; vierge; encliquetable

www.wago.com/793-501/000-006



N° art.: 793-501/000-007
Carte de repérage WMB; en carte; non extensible; vierge; encliquetable

www.wago.com/793-501/000-007



N° art.: 793-501/000-012
Carte de repérage WMB; en carte; non extensible; vierge; encliquetable

www.wago.com/793-501/000-012



N° art.: 793-501/000-017
Carte de repérage WMB; en carte; non extensible; vierge; encliquetable

www.wago.com/793-501/000-017



N° art.: 793-501/000-023
Carte de repérage WMB; en carte; non extensible; vierge; encliquetable

www.wago.com/793-501/000-023



N° art.: 793-501/000-024
Carte de repérage WMB; en carte; non extensible; vierge; encliquetable

www.wago.com/793-501/000-024



N° art.: 793-502
Carte de repérage WMB; en carte; avec impression; 1 ... 10 (10x); non extensible; Impression horizontale; encliquetable

www.wago.com/793-502



N° art.: 793-502/000-002
Carte de repérage WMB; en carte; avec impression; 1 ... 10 (10x); non extensible; Impression horizontale; encliquetable

www.wago.com/793-502/000-002



N° art.: 793-502/000-005
Carte de repérage WMB; en carte; avec impression; 1 ... 10 (10x); non extensible; Impression horizontale; encliquetable

www.wago.com/793-502/000-005



N° art.: 793-502/000-006
Carte de repérage WMB; en carte; avec impression; 1 ... 10 (10x); non extensible; Impression horizontale; encliquetable

www.wago.com/793-502/000-006



N° art.: 793-502/000-007
Carte de repérage WMB; en carte; avec impression; 1 ... 10 (10x); non extensible; Impression horizontale; encliquetable

www.wago.com/793-502/000-007



N° art.: 793-502/000-012
Carte de repérage WMB; en carte; avec impression; 1 ... 10 (10x); non extensible; Impression horizontale; encliquetable

www.wago.com/793-502/000-012

















N° art.: 793-502/000-017
Carte de repérage WMB; en carte; avec impression; 1 ... 10 (10x); non extensible; Impression horizontale; encliquetable















www.wago.com/793-502/000-017



N° art.: 793-502/000-023
Carte de repérage WMB; en carte; avec impression; 1 ... 10 (10x); non extensible; Impression horizontale; encliquetable

www.wago.com/793-502/000-023

	<p>N° art.: 793-502/000-024 Carte de repérage WMB; en carte; avec impression; 1 ... 10 (10x); non extensible; Impression horizontale; encliquetable</p>	www.wago.com/793-502/000-024
	<p>N° art.: 793-503 Carte de repérage WMB; en carte; avec impression; 11 ... 20 (10x); non extensible; Impression horizontale; encliquetable</p>	www.wago.com/793-503
	<p>N° art.: 793-503/000-002 Carte de repérage WMB; en carte; avec impression; 11 ... 20 (10x); non extensible; Impression horizontale; encliquetable</p>	www.wago.com/793-503/000-002
	<p>N° art.: 793-503/000-005 Carte de repérage WMB; en carte; avec impression; 11 ... 20 (10x); non extensible; Impression horizontale; encliquetable</p>	www.wago.com/793-503/000-005
	<p>N° art.: 793-503/000-006 Carte de repérage WMB; en carte; avec impression; 11 ... 20 (10x); non extensible; Impression horizontale; encliquetable</p>	www.wago.com/793-503/000-006
	<p>N° art.: 793-503/000-007 Carte de repérage WMB; en carte; avec impression; 11 ... 20 (10x); non extensible; Impression horizontale; encliquetable</p>	www.wago.com/793-503/000-007
	<p>N° art.: 793-503/000-012 Carte de repérage WMB; en carte; avec impression; 11 ... 20 (10x); non extensible; Impression horizontale; encliquetable</p>	www.wago.com/793-503/000-012
	<p>N° art.: 793-503/000-017 Carte de repérage WMB; en carte; avec impression; 11 ... 20 (10x); non extensible; Impression horizontale; encliquetable</p>	www.wago.com/793-503/000-017
	<p>N° art.: 793-503/000-023 Carte de repérage WMB; en carte; avec impression; 11 ... 20 (10x); non extensible; Impression horizontale; encliquetable</p>	www.wago.com/793-503/000-023
	<p>N° art.: 793-503/000-024 Carte de repérage WMB; en carte; avec impression; 11 ... 20 (10x); non extensible; Impression horizontale; encliquetable</p>	www.wago.com/793-503/000-024
	<p>N° art.: 793-504 Carte de repérage WMB; en carte; avec impression; 21 ... 30 (10x); non extensible; Impression horizontale; encliquetable</p>	www.wago.com/793-504
	<p>N° art.: 793-504/000-002 Carte de repérage WMB; en carte; avec impression; 21 ... 30 (10x); non extensible; Impression horizontale; encliquetable</p>	www.wago.com/793-504/000-002
	<p>N° art.: 793-504/000-005 Carte de repérage WMB; en carte; avec impression; 21 ... 30 (10x); non extensible; Impression horizontale; encliquetable</p>	www.wago.com/793-504/000-005
	<p>N° art.: 793-504/000-006 Carte de repérage WMB; en carte; avec impression; 21 ... 30 (10x); non extensible; Impression horizontale; encliquetable</p>	www.wago.com/793-504/000-006
	<p>N° art.: 793-504/000-012 Carte de repérage WMB; en carte; avec impression; 21 ... 30 (10x); non extensible; Impression horizontale; encliquetable</p>	www.wago.com/793-504/000-012

	<p>N° art.: 793-504/000-017 Carte de repérage WMB; en carte; avec impression; 21 ... 30 (10x); non extensible; Impression horizontale; encliquetable</p>	www.wago.com/793-504/000-017
	<p>N° art.: 793-504/000-023 Carte de repérage WMB; en carte; avec impression; 21 ... 30 (10x); non extensible; Impression horizontale; encliquetable</p>	www.wago.com/793-504/000-023
	<p>N° art.: 793-505 Carte de repérage WMB; en carte; avec impression; 31 ... 40 (10x); non extensible; Impression horizontale; encliquetable</p>	www.wago.com/793-505
	<p>N° art.: 793-505/000-005 Carte de repérage WMB; en carte; avec impression; 31 ... 40 (10x); non extensible; Impression horizontale; encliquetable</p>	www.wago.com/793-505/000-005
	<p>N° art.: 793-505/000-006 Carte de repérage WMB; en carte; avec impression; 31 ... 40 (10x); non extensible; Impression horizontale; encliquetable</p>	www.wago.com/793-505/000-006
	<p>N° art.: 793-505/000-007 Carte de repérage WMB; en carte; avec impression; 31 ... 40 (10x); non extensible; Impression horizontale; encliquetable</p>	www.wago.com/793-505/000-007
	<p>N° art.: 793-505/000-012 Carte de repérage WMB; en carte; avec impression; 31 ... 40 (10x); non extensible; Impression horizontale; encliquetable</p>	www.wago.com/793-505/000-012
	<p>N° art.: 793-506 Carte de repérage WMB; en carte; avec impression; 41 ... 50 (10x); non extensible; Impression horizontale; encliquetable</p>	www.wago.com/793-506
	<p>N° art.: 793-506/000-005 Carte de repérage WMB; en carte; avec impression; 41 ... 50 (10x); non extensible; Impression horizontale; encliquetable</p>	www.wago.com/793-506/000-005
	<p>N° art.: 793-506/000-006 Carte de repérage WMB; en carte; avec impression; 41 ... 50 (10x); non extensible; Impression horizontale; encliquetable</p>	www.wago.com/793-506/000-006
	<p>N° art.: 793-506/000-012 Carte de repérage WMB; en carte; avec impression; 41 ... 50 (10x); non extensible; Impression horizontale; encliquetable</p>	www.wago.com/793-506/000-012
	<p>N° art.: 793-506/000-017 Carte de repérage WMB; en carte; avec impression; 41 ... 50 (10x); non extensible; Impression horizontale; encliquetable</p>	www.wago.com/793-506/000-017
	<p>N° art.: 793-5501 Carte de repérage WMB; en carte; largeur des bornes 5 - 17,5 mm; extensible 5 - 5,2 MM; vierge; encliquetable</p>	www.wago.com/793-5501
	<p>N° art.: 793-5501/000-002 Carte de repérage WMB; en carte; largeur des bornes 5 - 17,5 mm; extensible 5 - 5,2 MM; vierge; encliquetable</p>	www.wago.com/793-5501/000-002
	<p>N° art.: 793-5501/000-005 Carte de repérage WMB; en carte; extensible 5 - 5,2 MM; vierge; encliquetable</p>	www.wago.com/793-5501/000-005



N° art.: 793-5501/000-006
Carte de repérage WMB; en carte; extensible 5 - 5,2 MM; vierge; encliquetable

www.wago.com/793-5501/000-006



N° art.: 793-5501/000-007
Carte de repérage WMB; en carte; extensible 5 - 5,2 MM; vierge; encliquetable

www.wago.com/793-5501/000-007



N° art.: 793-5501/000-012
Carte de repérage WMB; en carte; extensible 5 - 5,2 MM; vierge; encliquetable

www.wago.com/793-5501/000-012



N° art.: 793-5501/000-014
Carte de repérage WMB; en carte; extensible 5 - 5,2 MM; vierge; encliquetable

www.wago.com/793-5501/000-014



N° art.: 793-5501/000-017
Carte de repérage WMB; en carte; extensible 5 - 5,2 MM; vierge; encliquetable

www.wago.com/793-5501/000-017



N° art.: 793-5501/000-023
Carte de repérage WMB; en carte; extensible 5 - 5,2 MM; vierge; encliquetable

www.wago.com/793-5501/000-023



N° art.: 793-5501/000-024
Carte de repérage WMB; en carte; extensible 5 - 5,2 MM; vierge; encliquetable

www.wago.com/793-5501/000-024



N° art.: 793-566
Carte de repérage WMB; en carte; avec impression; 1 ... 50 (2x); non extensible; Impression horizontale; encliquetable

www.wago.com/793-566



N° art.: 793-566/000-002
Carte de repérage WMB; en carte; avec impression; 1 ... 50 (2x); non extensible; Impression horizontale; encliquetable

www.wago.com/793-566/000-002



N° art.: 793-566/000-005
Carte de repérage WMB; en carte; avec impression; 1 ... 50 (2x); non extensible; Impression horizontale; encliquetable

www.wago.com/793-566/000-005



N° art.: 793-566/000-006
Carte de repérage WMB; en carte; avec impression; 1 ... 50 (2x); non extensible; Impression horizontale; encliquetable

www.wago.com/793-566/000-006



N° art.: 793-566/000-007
Carte de repérage WMB; en carte; avec impression; 1 ... 50 (2x); non extensible; Impression horizontale; encliquetable

www.wago.com/793-566/000-007



N° art.: 793-566/000-012
Carte de repérage WMB; en carte; avec impression; 1 ... 50 (2x); non extensible; Impression horizontale; encliquetable

www.wago.com/793-566/000-012



N° art.: 793-566/000-017
Carte de repérage WMB; en carte; avec impression; 1 ... 50 (2x); non extensible; Impression horizontale; encliquetable

www.wago.com/793-566/000-017



N° art.: 793-566/000-023
Carte de repérage WMB; en carte; avec impression; 1 ... 50 (2x); non extensible; Impression horizontale; encliquetable

www.wago.com/793-566/000-023



N° art.: 793-566/000-024

Carte de repérage WMB; en carte; avec impression; 1 ... 50 (2x); non extensible; Impression horizontale; encliquetable

www.wago.com/793-566/000-024

Jumper



N° art.: 281-482

Peigne de pontage; isolé; 2 raccords; IN = IN borne

www.wago.com/281-482



N° art.: 859-402

Peigne de pontage; 2 raccords; Courant nominal 18 A; isolé

www.wago.com/859-402



N° art.: 859-402/000-005

Peigne de pontage; 2 raccords; Courant nominal 18 A; isolé

www.wago.com/859-402/000-005



N° art.: 859-402/000-006

Peigne de pontage; 2 raccords; Courant nominal 18 A; isolé

www.wago.com/859-402/000-006



N° art.: 859-402/000-029

Peigne de pontage; 2 raccords; Courant nominal 18 A; isolé

www.wago.com/859-402/000-029



N° art.: 859-403

Peigne de pontage; 3 raccords; Courant nominal 18 A; isolé

www.wago.com/859-403



N° art.: 859-403/000-005

Peigne de pontage; 3 raccords; Courant nominal 18 A; isolé

www.wago.com/859-403/000-005



N° art.: 859-403/000-006

Peigne de pontage; 3 raccords; Courant nominal 18 A; isolé

www.wago.com/859-403/000-006



N° art.: 859-403/000-029

Peigne de pontage; 3 raccords; Courant nominal 18 A; isolé

www.wago.com/859-403/000-029



N° art.: 859-404

Peigne de pontage; 4 raccords; Courant nominal 18 A; isolé

www.wago.com/859-404



N° art.: 859-404/000-005

Peigne de pontage; 4 raccords; Courant nominal 18 A; isolé

www.wago.com/859-404/000-005



N° art.: 859-404/000-006

Peigne de pontage; 4 raccords; Courant nominal 18 A; isolé

www.wago.com/859-404/000-006



N° art.: 859-404/000-029

Peigne de pontage; 4 raccords; Courant nominal 18 A; isolé















www.wago.com/859-404/000-029











N° art.: 859-405



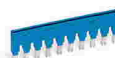

Peigne de pontage; 5 raccords; Courant nominal 18 A; isolé

www.wago.com/859-405

	N° art.: 859-405/000-005 Peigne de pontage; 5 raccords; Courant nominal 18 A; isolé	www.wago.com/859-405/000-005
	N° art.: 859-405/000-006 Peigne de pontage; 5 raccords; Courant nominal 18 A; isolé	www.wago.com/859-405/000-006
	N° art.: 859-405/000-029 Peigne de pontage; 5 raccords; Courant nominal 18 A; isolé	www.wago.com/859-405/000-029
	N° art.: 859-406 Peigne de pontage; 6 raccords; Courant nominal 18 A; isolé	www.wago.com/859-406
	N° art.: 859-406/000-005 Peigne de pontage; 6 raccords; Courant nominal 18 A; isolé	www.wago.com/859-406/000-005
	N° art.: 859-406/000-006 Peigne de pontage; 6 raccords; Courant nominal 18 A; isolé	www.wago.com/859-406/000-006
	N° art.: 859-406/000-029 Peigne de pontage; 6 raccords; Courant nominal 18 A; isolé	www.wago.com/859-406/000-029
	N° art.: 859-407 Peigne de pontage; 7 raccords; Courant nominal 18 A; isolé	www.wago.com/859-407
	N° art.: 859-407/000-005 Peigne de pontage; 7 raccords; Courant nominal 18 A; isolé	www.wago.com/859-407/000-005
	N° art.: 859-407/000-006 Peigne de pontage; 7 raccords; Courant nominal 18 A; isolé	www.wago.com/859-407/000-006
	N° art.: 859-407/000-029 Peigne de pontage; 7 raccords; Courant nominal 18 A; isolé	www.wago.com/859-407/000-029
	N° art.: 859-408 Peigne de pontage; 8 raccords; Courant nominal 18 A; isolé	www.wago.com/859-408
	N° art.: 859-408/000-005 Peigne de pontage; 8 raccords; Courant nominal 18 A; isolé	www.wago.com/859-408/000-005
	N° art.: 859-408/000-006 Peigne de pontage; 8 raccords; Courant nominal 18 A; isolé	www.wago.com/859-408/000-006
	N° art.: 859-408/000-029 Peigne de pontage; 8 raccords; Courant nominal 18 A; isolé	www.wago.com/859-408/000-029

	N° art.: 859-409 Peigne de pontage; 9 raccords; Courant nominal 18 A; isolé	www.wago.com/859-409
	N° art.: 859-409/000-005 Peigne de pontage; 9 raccords; Courant nominal 18 A; isolé	www.wago.com/859-409/000-005
	N° art.: 859-409/000-006 Peigne de pontage; 9 raccords; Courant nominal 18 A; isolé	www.wago.com/859-409/000-006
	N° art.: 859-409/000-029 Peigne de pontage; 9 raccords; Courant nominal 18 A; isolé	www.wago.com/859-409/000-029
	N° art.: 859-410 Peigne de pontage; 10 raccords; Courant nominal 18 A; isolé	www.wago.com/859-410
	N° art.: 859-410/000-005 Peigne de pontage; 10 raccords; Courant nominal 18 A; isolé	www.wago.com/859-410/000-005
	N° art.: 859-410/000-006 Peigne de pontage; 10 raccords; Courant nominal 18 A; isolé	www.wago.com/859-410/000-006
	N° art.: 859-410/000-029 Peigne de pontage; 10 raccords; Courant nominal 18 A; isolé	www.wago.com/859-410/000-029

ferrule

	N° art.: 216-241 Embout d'extrémité; embout pour 0,5 mm ² / AWG 22; avec isolation plastique; étamés par électrolyse; Cuivre électrolytique; serti de manière étanche aux gaz; selon DIN 46228, partie 4/09.90	www.wago.com/216-241
	N° art.: 216-242 Embout d'extrémité; embout pour 0,75 mm ² / AWG 20; avec isolation plastique; étamés par électrolyse; Cuivre électrolytique; serti de manière étanche aux gaz; selon DIN 46228, partie 4/09.90	www.wago.com/216-242
	N° art.: 216-243 Embout d'extrémité; embout pour 1 mm ² / AWG 18; avec isolation plastique; étamés par électrolyse; Cuivre électrolytique; serti de manière étanche aux gaz; selon DIN 46228, partie 4/09.90	www.wago.com/216-243
	N° art.: 216-244 Embout d'extrémité; embout pour 1,5 mm ² / AWG 16; avec isolation plastique; étamés par électrolyse; Cuivre électrolytique; serti de manière étanche aux gaz; selon DIN 46228, partie 4/09.90	www.wago.com/216-244

Téléchargements

Documentation

Bid Text

857-303	Jan 15, 2016	DOC	Téléchargement
Relaisbaustein		27,1 kB	

Instruction Leaflet



Sockets, relay module, optocoupler module Nominal input voltage 24 VDC, switching current 0.1 A	Jul 7, 2016	PDF 2,4 MB	Téléchargement
--	-------------	---------------	----------------

Additional Information

Disposal; Electrical and electronic equipment, Packaging	V 1.0.0 Oct 15, 2018	PDF 269,1 kB	Téléchargement
--	-------------------------	-----------------	----------------

smartDATA

CAD data

3D Download 857-303		URL	Téléchargement
Step file 857-03xx Series	1.0 Jun 30, 2011	STP 299,3 kB	Téléchargement

Sous réserve de modifications.