

Fiche technique | Numéro d'article: 857-704

Module relais statique; Tension nominale d'entrée DC 24 V; Plage de tension de sortie DC 0 ... 48 V; Limitation courant constant 0,1 A; Indication d'état des capteurs/actionneurs jaune; Largeur 6 mm

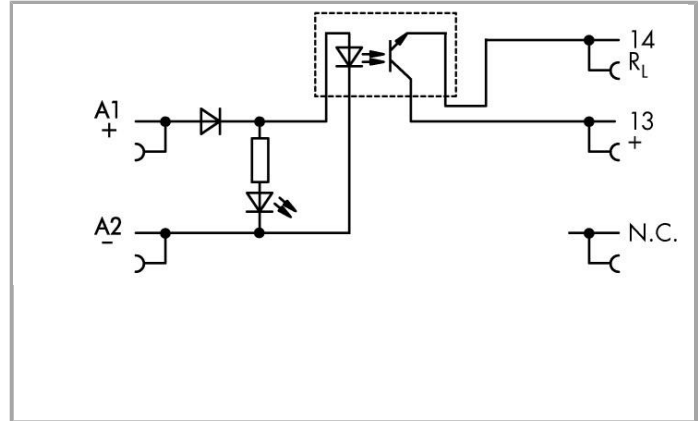

www.wago.com/857-704



RoHS Compliant

[BOMcheck.net](https://www.bomcheck.net)

Couleur: ■

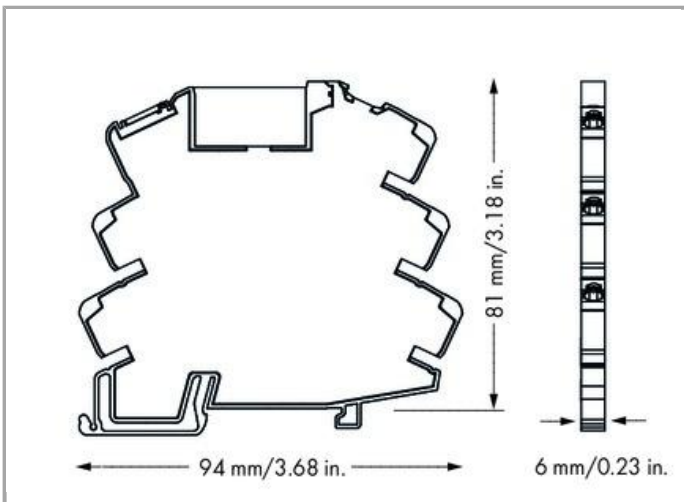

Description du produit :

Note:

Note : les optocoupleurs et relais statiques enfichables sont destinés à une utilisation dans des réseaux de traitement de signaux, ne provenant pas directement d'un réseau d'alimentation basse tension.

Données**Données techniques****Circuit de commande**

Nominal input voltage U_N	24 VDC
Input voltage range (low level)	0 ... 10 VDC
Input voltage range (high level)	16,8 ... 30 VDC
Courant d'entrée nominal I_N	9 mA

Circuit de charge

Type de circuit	Raccordement pour 2 conducteurs
Limiting continuous current	0,1 A
Output voltage range	0 ... 48 VDC
Max. voltage drop at output	≤ 1 VDC
Min. switching current	50 μ A
Temps d'excitation	≤ 100 μ s
Drop-out time	≤ 600 μ s
Switching frequency	≤ 1 kHz

Signaling

Indication d'état	LED jaune
-------------------	-----------

Sécurité & Protection

Tension de claquage contact-bobine (AC, 1 min.)	3,75 kV _{rms}
Dielectric strength, control/load circuit (AC, 1 min)	3,75 kV _{rms}
Indice de protection	IP20

Données de raccordement

Technique de connexion	Push-in CAGE CLAMP®
Conducteur rigide	0,34 ... 2,5 mm ² / 22 ... 14 AWG
Conducteur souple	0,34 ... 2,5 mm ² / 22 ... 14 AWG
Longueur de dénudage	9 ... 10 mm / 0.35 ... 0.39 inch

Données géométriques

Largeur	6 mm / 0.236 inch
Profondeur à partir du niveau supérieur du rail	81 mm / 3.189 inch
Profondeur	94 mm / 3.701 inch

Données mécaniques

Type de montage	Rail 35
-----------------	---------

Données du matériau

Couleur	gris
Charge calorifique	0.619 MJ
Poids	29.789 g

Conditions d'environnement

Température ambiante admissible Fonctionnement pour U_N	-20 ... 60 °C
Température ambiante (stockage)	-40 ... 70 °C

Normes et spécifications



Normes/spécifications	EN 61000-6-2; EN 61000-6-3; EN 61373; EN 61010-2-201; UL 508
-----------------------	--

Dates commerciales

Country of origin	CN
GTIN	4045454835491
Customs Tariff No.	85364900990
Product Group	6 (Interface Electronics)

Autorisations / certificats

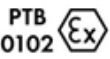
Ex-approbations



Logo	Approbation	Nom du certificat
	ATEX DEKRA EXAM GmbH	BVS_14_ATEX_E_091_X
	IECEX DEKRA EXAM GmbH	IECEX_BVS_14.0079_X

Approbations UL

Logo	Approbation	Nom du certificat
	UL UL International Netherlands B.V. (ORDINARY LOCATIONS)	E175199 Sec.4 (ORDINARY LOCATIONS)

Produits correspondants









General accessories

















	N° art.: 209-184 Protège-étiquettes	www.wago.com/209-184
	N° art.: 249-105 Porte-étiquettes de groupe	www.wago.com/249-105
	N° art.: 857-164 Relais statique élémentaire; Tension nominale d'entrée DC 24 V; Plage de tension de sortie DC 0 ... 48 V	www.wago.com/857-164













tools

	N° art.: 210-720 Outil de manipulation, partiellement isolé; Type 2, lame (3,5 x 0,5) mm	www.wago.com/210-720
--	---	--



Jumper

















	N° art.: 281-482 Peigne de pontage; isolé; 2 raccords; IN = IN borne	www.wago.com/281-482
	N° art.: 859-402 Peigne de pontage; 2 raccords; Courant nominal 18 A; isolé	www.wago.com/859-402
	N° art.: 859-402/000-005 Peigne de pontage; 2 raccords; Courant nominal 18 A; isolé	www.wago.com/859-402/000-005
	N° art.: 859-402/000-006 Peigne de pontage; 2 raccords; Courant nominal 18 A; isolé	www.wago.com/859-402/000-006
	N° art.: 859-402/000-029 Peigne de pontage; 2 raccords; Courant nominal 18 A; isolé	www.wago.com/859-402/000-029
	N° art.: 859-403 Peigne de pontage; 3 raccords; Courant nominal 18 A; isolé	www.wago.com/859-403
	N° art.: 859-403/000-005 Peigne de pontage; 3 raccords; Courant nominal 18 A; isolé	www.wago.com/859-403/000-005
	N° art.: 859-403/000-006 Peigne de pontage; 3 raccords; Courant nominal 18 A; isolé	www.wago.com/859-403/000-006

	N° art.: 859-403/000-029 Peigne de pontage; 3 raccords; Courant nominal 18 A; isolé	www.wago.com/859-403/000-029
	N° art.: 859-404 Peigne de pontage; 4 raccords; Courant nominal 18 A; isolé	www.wago.com/859-404
	N° art.: 859-404/000-005 Peigne de pontage; 4 raccords; Courant nominal 18 A; isolé	www.wago.com/859-404/000-005
	N° art.: 859-404/000-006 Peigne de pontage; 4 raccords; Courant nominal 18 A; isolé	www.wago.com/859-404/000-006
	N° art.: 859-404/000-029 Peigne de pontage; 4 raccords; Courant nominal 18 A; isolé	www.wago.com/859-404/000-029
	N° art.: 859-405 Peigne de pontage; 5 raccords; Courant nominal 18 A; isolé	www.wago.com/859-405
	N° art.: 859-405/000-005 Peigne de pontage; 5 raccords; Courant nominal 18 A; isolé	www.wago.com/859-405/000-005
	N° art.: 859-405/000-006 Peigne de pontage; 5 raccords; Courant nominal 18 A; isolé	www.wago.com/859-405/000-006
	N° art.: 859-405/000-029 Peigne de pontage; 5 raccords; Courant nominal 18 A; isolé	www.wago.com/859-405/000-029
	N° art.: 859-406 Peigne de pontage; 6 raccords; Courant nominal 18 A; isolé	www.wago.com/859-406
	N° art.: 859-406/000-005 Peigne de pontage; 6 raccords; Courant nominal 18 A; isolé	www.wago.com/859-406/000-005
	N° art.: 859-406/000-006 Peigne de pontage; 6 raccords; Courant nominal 18 A; isolé	www.wago.com/859-406/000-006
	N° art.: 859-406/000-029 Peigne de pontage; 6 raccords; Courant nominal 18 A; isolé	www.wago.com/859-406/000-029
	N° art.: 859-407 Peigne de pontage; 7 raccords; Courant nominal 18 A; isolé	www.wago.com/859-407
	N° art.: 859-407/000-005 Peigne de pontage; 7 raccords; Courant nominal 18 A; isolé	www.wago.com/859-407/000-005
	N° art.: 859-407/000-006 Peigne de pontage; 7 raccords; Courant nominal 18 A; isolé	www.wago.com/859-407/000-006

	N° art.: 859-407/000-029 Peigne de pontage; 7 raccords; Courant nominal 18 A; isolé	www.wago.com/859-407/000-029
	N° art.: 859-408 Peigne de pontage; 8 raccords; Courant nominal 18 A; isolé	www.wago.com/859-408
	N° art.: 859-408/000-005 Peigne de pontage; 8 raccords; Courant nominal 18 A; isolé	www.wago.com/859-408/000-005
	N° art.: 859-408/000-006 Peigne de pontage; 8 raccords; Courant nominal 18 A; isolé	www.wago.com/859-408/000-006
	N° art.: 859-408/000-029 Peigne de pontage; 8 raccords; Courant nominal 18 A; isolé	www.wago.com/859-408/000-029
	N° art.: 859-409 Peigne de pontage; 9 raccords; Courant nominal 18 A; isolé	www.wago.com/859-409
	N° art.: 859-409/000-005 Peigne de pontage; 9 raccords; Courant nominal 18 A; isolé	www.wago.com/859-409/000-005
	N° art.: 859-409/000-006 Peigne de pontage; 9 raccords; Courant nominal 18 A; isolé	www.wago.com/859-409/000-006
	N° art.: 859-409/000-029 Peigne de pontage; 9 raccords; Courant nominal 18 A; isolé	www.wago.com/859-409/000-029
	N° art.: 859-410 Peigne de pontage; 10 raccords; Courant nominal 18 A; isolé	www.wago.com/859-410
	N° art.: 859-410/000-005 Peigne de pontage; 10 raccords; Courant nominal 18 A; isolé	www.wago.com/859-410/000-005
	N° art.: 859-410/000-006 Peigne de pontage; 10 raccords; Courant nominal 18 A; isolé	www.wago.com/859-410/000-006
	N° art.: 859-410/000-029 Peigne de pontage; 10 raccords; Courant nominal 18 A; isolé	www.wago.com/859-410/000-029

Marking accessories

	N° art.: 2009-110 Bandes de marquage; sur rouleau; non extensible; vierge; encliquetable	www.wago.com/2009-110
	N° art.: 2009-115 WMB-Inline; pour smartPRINTER; sur rouleau; extensible 5 - 5,2 MM; vierge; encliquetable	www.wago.com/2009-115

	<p>N° art.: 2009-115/000-002 WMB-Inline; pour smartPRINTER; sur rouleau; extensible 5 - 5,2 MM; vierge; encliquetable</p>	<p>www.wago.com/2009-115/000-002</p>
	<p>N° art.: 2009-115/000-006 WMB-Inline; pour smartPRINTER; sur rouleau; extensible 5 - 5,2 MM; vierge; encliquetable</p>	<p>www.wago.com/2009-115/000-006</p>
	<p>N° art.: 2009-115/000-007 WMB-Inline; sur rouleau; extensible 5 - 5,2 MM; vierge; encliquetable</p>	<p>www.wago.com/2009-115/000-007</p>
	<p>N° art.: 2009-115/000-012 WMB-Inline; pour smartPRINTER; sur rouleau; extensible 5 - 5,2 MM; vierge; encliquetable</p>	<p>www.wago.com/2009-115/000-012</p>
	<p>N° art.: 2009-115/000-017 WMB-Inline; sur rouleau; extensible 5 - 5,2 MM; vierge; encliquetable</p>	<p>www.wago.com/2009-115/000-017</p>
	<p>N° art.: 2009-115/000-023 WMB-Inline; pour smartPRINTER; sur rouleau; extensible 5 - 5,2 MM; vierge; encliquetable</p>	<p>www.wago.com/2009-115/000-023</p>
	<p>N° art.: 2009-115/000-024 WMB-Inline; pour smartPRINTER; sur rouleau; extensible 5 - 5,2 MM; vierge; encliquetable</p>	<p>www.wago.com/2009-115/000-024</p>
	<p>N° art.: 209-128 Adaptateur</p>	<p>www.wago.com/209-128</p>
	<p>N° art.: 209-183 Étiquette à enficher</p>	<p>www.wago.com/209-183</p>
	<p>N° art.: 210-110 Stylo feutre-graveur</p>	<p>www.wago.com/210-110</p>
	<p>N° art.: 793-501 Carte de repérage WMB; en carte; non extensible; vierge; encliquetable</p>	<p>www.wago.com/793-501</p>
	<p>N° art.: 793-501/000-002 Carte de repérage WMB; en carte; non extensible; vierge; encliquetable</p>	<p>www.wago.com/793-501/000-002</p>
	<p>N° art.: 793-501/000-005 Carte de repérage WMB; en carte; non extensible; vierge; encliquetable</p>	<p>www.wago.com/793-501/000-005</p>
	<p>N° art.: 793-501/000-006 Carte de repérage WMB; en carte; non extensible; vierge; encliquetable</p>	<p>www.wago.com/793-501/000-006</p>
	<p>N° art.: 793-501/000-007 Carte de repérage WMB; en carte; non extensible; vierge; encliquetable</p>	<p>www.wago.com/793-501/000-007</p>
	<p>N° art.: 793-501/000-012 Carte de repérage WMB; en carte; non extensible; vierge; encliquetable</p>	<p>www.wago.com/793-501/000-012</p>



N° art.: 793-501/000-017
 Carte de repérage WMB; en carte; non extensible; vierge; encliquetable

www.wago.com/793-501/000-017



N° art.: 793-501/000-023
 Carte de repérage WMB; en carte; non extensible; vierge; encliquetable

www.wago.com/793-501/000-023



N° art.: 793-501/000-024
 Carte de repérage WMB; en carte; non extensible; vierge; encliquetable

www.wago.com/793-501/000-024



N° art.: 793-502
 Carte de repérage WMB; en carte; avec impression; 1 ... 10 (10x); non extensible; Impression horizontale; encliquetable

www.wago.com/793-502



N° art.: 793-502/000-002
 Carte de repérage WMB; en carte; avec impression; 1 ... 10 (10x); non extensible; Impression horizontale; encliquetable

www.wago.com/793-502/000-002



N° art.: 793-502/000-005
 Carte de repérage WMB; en carte; avec impression; 1 ... 10 (10x); non extensible; Impression horizontale; encliquetable

www.wago.com/793-502/000-005



N° art.: 793-502/000-006
 Carte de repérage WMB; en carte; avec impression; 1 ... 10 (10x); non extensible; Impression horizontale; encliquetable

www.wago.com/793-502/000-006



N° art.: 793-502/000-007
 Carte de repérage WMB; en carte; avec impression; 1 ... 10 (10x); non extensible; Impression horizontale; encliquetable

www.wago.com/793-502/000-007



N° art.: 793-502/000-012
 Carte de repérage WMB; en carte; avec impression; 1 ... 10 (10x); non extensible; Impression horizontale; encliquetable

www.wago.com/793-502/000-012



N° art.: 793-502/000-017
 Carte de repérage WMB; en carte; avec impression; 1 ... 10 (10x); non extensible; Impression horizontale; encliquetable

www.wago.com/793-502/000-017



N° art.: 793-502/000-023
 Carte de repérage WMB; en carte; avec impression; 1 ... 10 (10x); non extensible; Impression horizontale; encliquetable

www.wago.com/793-502/000-023



N° art.: 793-502/000-024
 Carte de repérage WMB; en carte; avec impression; 1 ... 10 (10x); non extensible; Impression horizontale; encliquetable

www.wago.com/793-502/000-024



N° art.: 793-503
 Carte de repérage WMB; en carte; avec impression; 11 ... 20 (10x); non extensible; Impression horizontale; encliquetable

www.wago.com/793-503

















N° art.: 793-503/000-002
 Carte de repérage WMB; en carte; avec impression; 11 ... 20 (10x); non extensible; Impression horizontale; encliquetable















www.wago.com/793-503/000-002



N° art.: 793-503/000-005
 Carte de repérage WMB; en carte; avec impression; 11 ... 20 (10x); non extensible; Impression horizontale; encliquetable

www.wago.com/793-503/000-005

	<p>N° art.: 793-503/000-006 Carte de repérage WMB; en carte; avec impression; 11 ... 20 (10x); non extensible; Impression horizontale; encliquetable</p>	<p>www.wago.com/793-503/000-006</p>
	<p>N° art.: 793-503/000-007 Carte de repérage WMB; en carte; avec impression; 11 ... 20 (10x); non extensible; Impression horizontale; encliquetable</p>	<p>www.wago.com/793-503/000-007</p>
	<p>N° art.: 793-503/000-012 Carte de repérage WMB; en carte; avec impression; 11 ... 20 (10x); non extensible; Impression horizontale; encliquetable</p>	<p>www.wago.com/793-503/000-012</p>
	<p>N° art.: 793-503/000-017 Carte de repérage WMB; en carte; avec impression; 11 ... 20 (10x); non extensible; Impression horizontale; encliquetable</p>	<p>www.wago.com/793-503/000-017</p>
	<p>N° art.: 793-503/000-023 Carte de repérage WMB; en carte; avec impression; 11 ... 20 (10x); non extensible; Impression horizontale; encliquetable</p>	<p>www.wago.com/793-503/000-023</p>
	<p>N° art.: 793-503/000-024 Carte de repérage WMB; en carte; avec impression; 11 ... 20 (10x); non extensible; Impression horizontale; encliquetable</p>	<p>www.wago.com/793-503/000-024</p>
	<p>N° art.: 793-504 Carte de repérage WMB; en carte; avec impression; 21 ... 30 (10x); non extensible; Impression horizontale; encliquetable</p>	<p>www.wago.com/793-504</p>
	<p>N° art.: 793-504/000-002 Carte de repérage WMB; en carte; avec impression; 21 ... 30 (10x); non extensible; Impression horizontale; encliquetable</p>	<p>www.wago.com/793-504/000-002</p>
	<p>N° art.: 793-504/000-005 Carte de repérage WMB; en carte; avec impression; 21 ... 30 (10x); non extensible; Impression horizontale; encliquetable</p>	<p>www.wago.com/793-504/000-005</p>
	<p>N° art.: 793-504/000-006 Carte de repérage WMB; en carte; avec impression; 21 ... 30 (10x); non extensible; Impression horizontale; encliquetable</p>	<p>www.wago.com/793-504/000-006</p>
	<p>N° art.: 793-504/000-012 Carte de repérage WMB; en carte; avec impression; 21 ... 30 (10x); non extensible; Impression horizontale; encliquetable</p>	<p>www.wago.com/793-504/000-012</p>
	<p>N° art.: 793-504/000-017 Carte de repérage WMB; en carte; avec impression; 21 ... 30 (10x); non extensible; Impression horizontale; encliquetable</p>	<p>www.wago.com/793-504/000-017</p>
	<p>N° art.: 793-504/000-023 Carte de repérage WMB; en carte; avec impression; 21 ... 30 (10x); non extensible; Impression horizontale; encliquetable</p>	<p>www.wago.com/793-504/000-023</p>
	<p>N° art.: 793-505 Carte de repérage WMB; en carte; avec impression; 31 ... 40 (10x); non extensible; Impression horizontale; encliquetable</p>	<p>www.wago.com/793-505</p>
	<p>N° art.: 793-505/000-005 Carte de repérage WMB; en carte; avec impression; 31 ... 40 (10x); non extensible; Impression horizontale; encliquetable</p>	<p>www.wago.com/793-505/000-005</p>

	<p>N° art.: 793-505/000-006 Carte de repérage WMB; en carte; avec impression; 31 ... 40 (10x); non extensible; Impression horizontale; encliquetable</p>	www.wago.com/793-505/000-006
	<p>N° art.: 793-505/000-007 Carte de repérage WMB; en carte; avec impression; 31 ... 40 (10x); non extensible; Impression horizontale; encliquetable</p>	www.wago.com/793-505/000-007
	<p>N° art.: 793-505/000-012 Carte de repérage WMB; en carte; avec impression; 31 ... 40 (10x); non extensible; Impression horizontale; encliquetable</p>	www.wago.com/793-505/000-012
	<p>N° art.: 793-506 Carte de repérage WMB; en carte; avec impression; 41 ... 50 (10x); non extensible; Impression horizontale; encliquetable</p>	www.wago.com/793-506
	<p>N° art.: 793-506/000-005 Carte de repérage WMB; en carte; avec impression; 41 ... 50 (10x); non extensible; Impression horizontale; encliquetable</p>	www.wago.com/793-506/000-005
	<p>N° art.: 793-506/000-006 Carte de repérage WMB; en carte; avec impression; 41 ... 50 (10x); non extensible; Impression horizontale; encliquetable</p>	www.wago.com/793-506/000-006
	<p>N° art.: 793-506/000-012 Carte de repérage WMB; en carte; avec impression; 41 ... 50 (10x); non extensible; Impression horizontale; encliquetable</p>	www.wago.com/793-506/000-012
	<p>N° art.: 793-506/000-017 Carte de repérage WMB; en carte; avec impression; 41 ... 50 (10x); non extensible; Impression horizontale; encliquetable</p>	www.wago.com/793-506/000-017
	<p>N° art.: 793-5501 Carte de repérage WMB; en carte; largeur des bornes 5 - 17,5 mm; extensible 5 - 5,2 MM; vierge; encliquetable</p>	www.wago.com/793-5501
	<p>N° art.: 793-5501/000-002 Carte de repérage WMB; en carte; largeur des bornes 5 - 17,5 mm; extensible 5 - 5,2 MM; vierge; encliquetable</p>	www.wago.com/793-5501/000-002
	<p>N° art.: 793-5501/000-005 Carte de repérage WMB; en carte; extensible 5 - 5,2 MM; vierge; encliquetable</p>	www.wago.com/793-5501/000-005
	<p>N° art.: 793-5501/000-006 Carte de repérage WMB; en carte; extensible 5 - 5,2 MM; vierge; encliquetable</p>	www.wago.com/793-5501/000-006
	<p>N° art.: 793-5501/000-007 Carte de repérage WMB; en carte; extensible 5 - 5,2 MM; vierge; encliquetable</p>	www.wago.com/793-5501/000-007
	<p>N° art.: 793-5501/000-012 Carte de repérage WMB; en carte; extensible 5 - 5,2 MM; vierge; encliquetable</p>	www.wago.com/793-5501/000-012
	<p>N° art.: 793-5501/000-014 Carte de repérage WMB; en carte; extensible 5 - 5,2 MM; vierge; encliquetable</p>	www.wago.com/793-5501/000-014



N° art.: 793-5501/000-017
Carte de repérage WMB; en carte; extensible 5 - 5,2 MM; vierge; encliquetable

www.wago.com/793-5501/000-017



N° art.: 793-5501/000-023
Carte de repérage WMB; en carte; extensible 5 - 5,2 MM; vierge; encliquetable

www.wago.com/793-5501/000-023



N° art.: 793-5501/000-024
Carte de repérage WMB; en carte; extensible 5 - 5,2 MM; vierge; encliquetable

www.wago.com/793-5501/000-024



N° art.: 793-566
Carte de repérage WMB; en carte; avec impression; 1 ... 50 (2x); non extensible; Impression horizontale; encliquetable

www.wago.com/793-566



N° art.: 793-566/000-002
Carte de repérage WMB; en carte; avec impression; 1 ... 50 (2x); non extensible; Impression horizontale; encliquetable

www.wago.com/793-566/000-002



N° art.: 793-566/000-005
Carte de repérage WMB; en carte; avec impression; 1 ... 50 (2x); non extensible; Impression horizontale; encliquetable

www.wago.com/793-566/000-005



N° art.: 793-566/000-006
Carte de repérage WMB; en carte; avec impression; 1 ... 50 (2x); non extensible; Impression horizontale; encliquetable

www.wago.com/793-566/000-006



N° art.: 793-566/000-007
Carte de repérage WMB; en carte; avec impression; 1 ... 50 (2x); non extensible; Impression horizontale; encliquetable

www.wago.com/793-566/000-007



N° art.: 793-566/000-012
Carte de repérage WMB; en carte; avec impression; 1 ... 50 (2x); non extensible; Impression horizontale; encliquetable

www.wago.com/793-566/000-012



N° art.: 793-566/000-017
Carte de repérage WMB; en carte; avec impression; 1 ... 50 (2x); non extensible; Impression horizontale; encliquetable

www.wago.com/793-566/000-017



N° art.: 793-566/000-023
Carte de repérage WMB; en carte; avec impression; 1 ... 50 (2x); non extensible; Impression horizontale; encliquetable

www.wago.com/793-566/000-023



N° art.: 793-566/000-024
Carte de repérage WMB; en carte; avec impression; 1 ... 50 (2x); non extensible; Impression horizontale; encliquetable

www.wago.com/793-566/000-024

transfer module



N° art.: 857-981
Adaptateur d'interface; 14 pôles; Entrée à commutation positive

www.wago.com/857-981



N° art.: 857-982
Adaptateur d'interface; 14 pôles; Sortie à commutation positive

www.wago.com/857-982

ferrule

N° art.: 216-241



Embout d'extrémité; embout pour 0,5 mm² / AWG 22; avec isolation plastique; étamés par électrolyse; www.wago.com/216-241
Cuivre électrolytique; serti de manière étanche aux gaz; selon DIN 46228, partie 4/09.90

N° art.: 216-242



Embout d'extrémité; embout pour 0,75 mm² / AWG 20; avec isolation plastique; étamés par électrolyse; www.wago.com/216-242
Cuivre électrolytique; serti de manière étanche aux gaz; selon DIN 46228, partie 4/09.90

N° art.: 216-243



Embout d'extrémité; embout pour 1 mm² / AWG 18; avec isolation plastique; étamés par électrolyse; www.wago.com/216-243
Cuivre électrolytique; serti de manière étanche aux gaz; selon DIN 46228, partie 4/09.90



N° art.: 216-244

Embout d'extrémité; embout pour 1,5 mm² / AWG 16; avec isolation plastique; étamés par électrolyse; www.wago.com/216-244
Cuivre électrolytique; serti de manière étanche aux gaz; selon DIN 46228, partie 4/09.90

Téléchargements

Documentation

Instruction Leaflet

Relay Socket with Optocoupler Input nominal voltage DC 24 V, switching current 0.1 A	Dec 18, 2015	PDF 2,4 MB	Téléchargement
---	--------------	---------------	----------------

Additional Information

Disposal; Electrical and electronic equipment, Packaging	V 1.0.0 Oct 15, 2018	PDF 269,1 kB	Téléchargement
--	-------------------------	-----------------	----------------

smartDATA

CAD data

3D Download 857-704		URL	Téléchargement
Step file 857-07xx Series	1.0 Jun 30, 2011	STP 299,3 kB	Téléchargement

Sous réserve de modifications.