

# Fiche technique | Numéro d'article: 858-304

Module relais; Tension nominale d'entrée DC 24 V; 4 RT; Courant permanent limite 5 A; avec forçage manuel; Indication d'état rouge; Largeur 31 mm

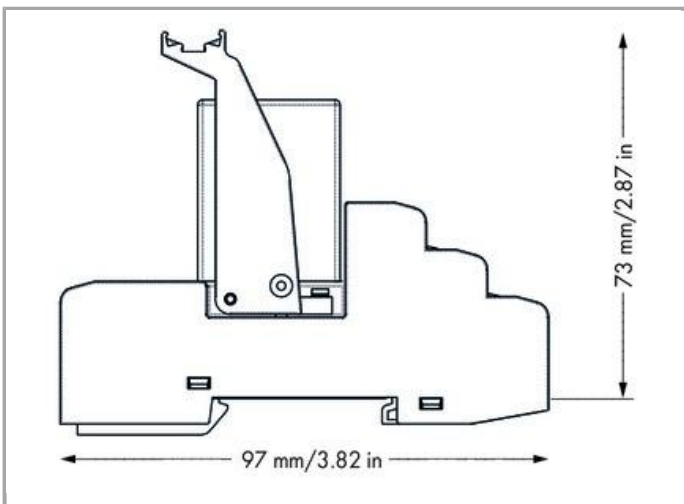

[www.wago.com/858-304](http://www.wago.com/858-304)

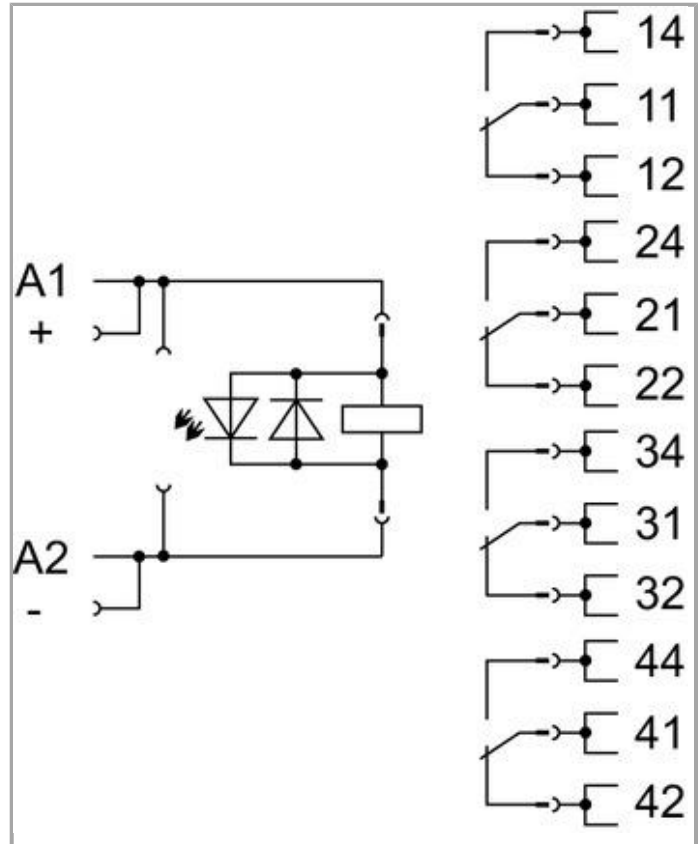

## Description du produit :

### Description :

Les embases enfichables de la série 858, pour montage sur rail (DIN 35), sont conçues pour les relais industriels usuels, avec embrochage standard. Ils peuvent accueillir des relais 2 ou 4 RT et des hauteurs de relais de 33,5 à 35 mm. Tous les points de contacts du socle possèdent une connexion

double Push-in CAGE CLAMP®-COMPACT pour les sections, au choix, 2 x 0,34 mm<sup>2</sup> à 1,5 mm<sup>2</sup> à 1 x 2,5 mm<sup>2</sup>. Les connexions Push-in CAGE CLAMP®-COMPACT autorisent le raccordement direct des conducteurs unifilaire et des conducteurs avec embout à partir de 0,5 mm<sup>2</sup>. Dans la pratique, ces socles permettent de remplacer rapidement les relais en cas de maintenance, sans toucher au câblage.

## Données

### Données techniques

#### Circuit de commande

Nominal input voltage $U_N$	24 VDC
Input voltage range	-20 ... +10 %
Courant d'entrée nominal IN	36.9 mA

#### Circuit de charge

Nombre relais 1 T/contacts inverseurs	4
Contact material (relay)	AgCe
Limiting continuous current	5 A
Max. make current (resistive)	4 s 15 A (AC)
Max. switching voltage	250 VAC
Max. switching power (resistive)	1250 VAAC; DC see load limit curve
Charge min. recommandée	12 V / 100 mA
Temps de montée typ.	25 ms
Temps de relâchement	25 ms
Temps de rebondissement (typ.)	4 ms
Electrical life (N.O.; resistive load; 23 °C)	100 x 10 <sup>3</sup> switching operations
Mechanical life (N.O.; resistive load; 23 °C)	20 x 10 <sup>6</sup> switching operations

#### Signaling

Indication d'état	LED red Mechanical
-------------------	-----------------------

#### Sécurité & Protection

Tension de référence	250 V
Tension assignée de tenue aux chocs	2.5 kV
Degré de pollution	2
Tension de claquage contact-bobine (AC, 1 min.)	1.5 kV <sub>rms</sub>
Dielectric strength, control/load circuit (AC, 1 min)	1,5 kV <sub>rms</sub>
Tension de claquage contact ouvert (AC, 1 min)	1 kV <sub>rms</sub>
Dielectric strength open contact (AC, 1 min)	1 kV <sub>rms</sub>

Tension de claquage, contact adjacent (AC, 1 min)	1.5 kV <sub>rms</sub>
Dielectric strength, load/load circuit (AC, 1 min)	1,5 kV <sub>rms</sub>
Indice de protection	IP20

### Données de raccordement

Nombre de types de connexion	2
Technique de connexion	Push-in CAGE CLAMP®
Conducteur rigide	0,34 ... 1,5 mm <sup>2</sup> / 22 ... 16 AWG
Conducteur souple	0,34 ... 1,5 mm <sup>2</sup> / 22 ... 16 AWG
Longueur de dénudage	9 ... 10 mm / 0.35 ... 0.39 inch

### Données géométriques

Largeur	31 mm / 1.22 inch
Profondeur à partir du niveau supérieur du rail	73 mm / 2.874 inch
Profondeur	97 mm / 3.819 inch

### Données mécaniques

Type de montage	Rail 35
-----------------	---------

### Données du matériau

Poids	96 g
-------	------

### Conditions d'environnement

Température ambiante admissible Fonctionnement pour U <sub>N</sub>	-25 ... 70 °C
Température ambiante (stockage)	-40 ... 80 °C
Température ambiante pour fonctionnement pour UL	-25 ... 50 °C
Degré de pollution	2

### Normes et spécifications

Normes/spécifications	EN 61010-2-201; EN 61810-1; EN 61373; GL; UL 508 (max. 50 °C)
-----------------------	---

### Elementary relay

WAGO elementary relay	858-150
-----------------------	---------



### Dates commerciales

Country of origin	DE
GTIN	4055143567770

Customs Tariff No.	85364900990
Product Group	6 (Interface Electronics)

## Autorisations / certificats

### Approbations de navire





Logo	Approbation	Nom du certificat
	<b>DNV GL</b> Det Norske Veritas, Germanischer Lloyd	TAA00001D1
	<b>NK</b> Nippon Kaiji Kyokai	TA17255M
	<b>PRS</b> Polski Rejestr Statkow	TE/1989/880590/13

### Approbations UL



Logo	Approbation	Nom du certificat
	<b>UL</b> UL International Netherlands B.V. (ORDINARY LOCATIONS)	E175199 Sec.6

















## Produits correspondants















### ferrule















	<b>N° art.: 216-241</b> Embout d'extrémité; embout pour 0,5 mm <sup>2</sup> / AWG 22; avec isolation plastique; étamés par électrolyse; Cuivre électrolytique; serti de manière étanche aux gaz; selon DIN 46228, partie 4/09.90	<a href="http://www.wago.com/216-241">www.wago.com/216-241</a>
	<b>N° art.: 216-242</b> Embout d'extrémité; embout pour 0,75 mm <sup>2</sup> / AWG 20; avec isolation plastique; étamés par électrolyse; Cuivre électrolytique; serti de manière étanche aux gaz; selon DIN 46228, partie 4/09.90	<a href="http://www.wago.com/216-242">www.wago.com/216-242</a>
	<b>N° art.: 216-243</b> Embout d'extrémité; embout pour 1 mm <sup>2</sup> / AWG 18; avec isolation plastique; étamés par électrolyse; Cuivre électrolytique; serti de manière étanche aux gaz; selon DIN 46228, partie 4/09.90	<a href="http://www.wago.com/216-243">www.wago.com/216-243</a>
	<b>N° art.: 216-244</b> Embout d'extrémité; embout pour 1,5 mm <sup>2</sup> / AWG 16; avec isolation plastique; étamés par électrolyse; Cuivre électrolytique; serti de manière étanche aux gaz; selon DIN 46228, partie 4/09.90	<a href="http://www.wago.com/216-244">www.wago.com/216-244</a>















### Marking accessories

	<b>N° art.: 2009-110</b> Bandes de marquage; sur rouleau; non extensible; vierge; encliquetable	<a href="http://www.wago.com/2009-110">www.wago.com/2009-110</a>
	<b>N° art.: 2009-115</b> WMB-Inline; pour smartPRINTER; sur rouleau; extensible 5 - 5,2 MM; vierge; encliquetable	<a href="http://www.wago.com/2009-115">www.wago.com/2009-115</a>

	<p><b>N° art.: 2009-115/000-002</b> WMB-Inline; pour smartPRINTER; sur rouleau; extensible 5 - 5,2 MM; vierge; encliquetable</p>	<a href="http://www.wago.com/2009-115/000-002">www.wago.com/2009-115/000-002</a>
	<p><b>N° art.: 2009-115/000-006</b> WMB-Inline; pour smartPRINTER; sur rouleau; extensible 5 - 5,2 MM; vierge; encliquetable</p>	<a href="http://www.wago.com/2009-115/000-006">www.wago.com/2009-115/000-006</a>
	<p><b>N° art.: 2009-115/000-007</b> WMB-Inline; sur rouleau; extensible 5 - 5,2 MM; vierge; encliquetable</p>	<a href="http://www.wago.com/2009-115/000-007">www.wago.com/2009-115/000-007</a>
	<p><b>N° art.: 2009-115/000-012</b> WMB-Inline; pour smartPRINTER; sur rouleau; extensible 5 - 5,2 MM; vierge; encliquetable</p>	<a href="http://www.wago.com/2009-115/000-012">www.wago.com/2009-115/000-012</a>
	<p><b>N° art.: 2009-115/000-017</b> WMB-Inline; sur rouleau; extensible 5 - 5,2 MM; vierge; encliquetable</p>	<a href="http://www.wago.com/2009-115/000-017">www.wago.com/2009-115/000-017</a>
	<p><b>N° art.: 2009-115/000-023</b> WMB-Inline; pour smartPRINTER; sur rouleau; extensible 5 - 5,2 MM; vierge; encliquetable</p>	<a href="http://www.wago.com/2009-115/000-023">www.wago.com/2009-115/000-023</a>
	<p><b>N° art.: 2009-115/000-024</b> WMB-Inline; pour smartPRINTER; sur rouleau; extensible 5 - 5,2 MM; vierge; encliquetable</p>	<a href="http://www.wago.com/2009-115/000-024">www.wago.com/2009-115/000-024</a>
	<p><b>N° art.: 209-128</b> Adaptateur</p>	<a href="http://www.wago.com/209-128">www.wago.com/209-128</a>
	<p><b>N° art.: 209-183</b> Étiquette à enficher</p>	<a href="http://www.wago.com/209-183">www.wago.com/209-183</a>
	<p><b>N° art.: 210-110</b> Stylo feutre-graveur</p>	<a href="http://www.wago.com/210-110">www.wago.com/210-110</a>
	<p><b>N° art.: 793-501</b> Carte de repérage WMB; en carte; non extensible; vierge; encliquetable</p>	<a href="http://www.wago.com/793-501">www.wago.com/793-501</a>
	<p><b>N° art.: 793-501/000-002</b> Carte de repérage WMB; en carte; non extensible; vierge; encliquetable</p>	<a href="http://www.wago.com/793-501/000-002">www.wago.com/793-501/000-002</a>
	<p><b>N° art.: 793-501/000-005</b> Carte de repérage WMB; en carte; non extensible; vierge; encliquetable</p>	<a href="http://www.wago.com/793-501/000-005">www.wago.com/793-501/000-005</a>
	<p><b>N° art.: 793-501/000-006</b> Carte de repérage WMB; en carte; non extensible; vierge; encliquetable</p>	<a href="http://www.wago.com/793-501/000-006">www.wago.com/793-501/000-006</a>
	<p><b>N° art.: 793-501/000-007</b> Carte de repérage WMB; en carte; non extensible; vierge; encliquetable</p>	<a href="http://www.wago.com/793-501/000-007">www.wago.com/793-501/000-007</a>
	<p><b>N° art.: 793-501/000-012</b> Carte de repérage WMB; en carte; non extensible; vierge; encliquetable</p>	<a href="http://www.wago.com/793-501/000-012">www.wago.com/793-501/000-012</a>

	<p><b>N° art.: 793-501/000-017</b> Carte de repérage WMB; en carte; non extensible; vierge; encliquetable</p>	<a href="http://www.wago.com/793-501/000-017">www.wago.com/793-501/000-017</a>
	<p><b>N° art.: 793-501/000-023</b> Carte de repérage WMB; en carte; non extensible; vierge; encliquetable</p>	<a href="http://www.wago.com/793-501/000-023">www.wago.com/793-501/000-023</a>
	<p><b>N° art.: 793-501/000-024</b> Carte de repérage WMB; en carte; non extensible; vierge; encliquetable</p>	<a href="http://www.wago.com/793-501/000-024">www.wago.com/793-501/000-024</a>
	<p><b>N° art.: 793-502</b> Carte de repérage WMB; en carte; avec impression; 1 ... 10 (10x); non extensible; Impression horizontale; encliquetable</p>	<a href="http://www.wago.com/793-502">www.wago.com/793-502</a>
	<p><b>N° art.: 793-502/000-002</b> Carte de repérage WMB; en carte; avec impression; 1 ... 10 (10x); non extensible; Impression horizontale; encliquetable</p>	<a href="http://www.wago.com/793-502/000-002">www.wago.com/793-502/000-002</a>
	<p><b>N° art.: 793-502/000-005</b> Carte de repérage WMB; en carte; avec impression; 1 ... 10 (10x); non extensible; Impression horizontale; encliquetable</p>	<a href="http://www.wago.com/793-502/000-005">www.wago.com/793-502/000-005</a>
	<p><b>N° art.: 793-502/000-006</b> Carte de repérage WMB; en carte; avec impression; 1 ... 10 (10x); non extensible; Impression horizontale; encliquetable</p>	<a href="http://www.wago.com/793-502/000-006">www.wago.com/793-502/000-006</a>
	<p><b>N° art.: 793-502/000-007</b> Carte de repérage WMB; en carte; avec impression; 1 ... 10 (10x); non extensible; Impression horizontale; encliquetable</p>	<a href="http://www.wago.com/793-502/000-007">www.wago.com/793-502/000-007</a>
	<p><b>N° art.: 793-502/000-012</b> Carte de repérage WMB; en carte; avec impression; 1 ... 10 (10x); non extensible; Impression horizontale; encliquetable</p>	<a href="http://www.wago.com/793-502/000-012">www.wago.com/793-502/000-012</a>
	<p><b>N° art.: 793-502/000-017</b> Carte de repérage WMB; en carte; avec impression; 1 ... 10 (10x); non extensible; Impression horizontale; encliquetable</p>	<a href="http://www.wago.com/793-502/000-017">www.wago.com/793-502/000-017</a>
	<p><b>N° art.: 793-502/000-023</b> Carte de repérage WMB; en carte; avec impression; 1 ... 10 (10x); non extensible; Impression horizontale; encliquetable</p>	<a href="http://www.wago.com/793-502/000-023">www.wago.com/793-502/000-023</a>
	<p><b>N° art.: 793-502/000-024</b> Carte de repérage WMB; en carte; avec impression; 1 ... 10 (10x); non extensible; Impression horizontale; encliquetable</p>	<a href="http://www.wago.com/793-502/000-024">www.wago.com/793-502/000-024</a>
	<p><b>N° art.: 793-503</b> Carte de repérage WMB; en carte; avec impression; 11 ... 20 (10x); non extensible; Impression horizontale; encliquetable</p>	<a href="http://www.wago.com/793-503">www.wago.com/793-503</a>
	<p><b>N° art.: 793-503/000-002</b> Carte de repérage WMB; en carte; avec impression; 11 ... 20 (10x); non extensible; Impression horizontale; encliquetable</p>	<a href="http://www.wago.com/793-503/000-002">www.wago.com/793-503/000-002</a>
	<p><b>N° art.: 793-503/000-005</b> Carte de repérage WMB; en carte; avec impression; 11 ... 20 (10x); non extensible; Impression horizontale; encliquetable</p>	<a href="http://www.wago.com/793-503/000-005">www.wago.com/793-503/000-005</a>

	<p><b>N° art.: 793-503/000-006</b> Carte de repérage WMB; en carte; avec impression; 11 ... 20 (10x); non extensible; Impression horizontale; encliquetable</p>	<a href="http://www.wago.com/793-503/000-006">www.wago.com/793-503/000-006</a>
	<p><b>N° art.: 793-503/000-007</b> Carte de repérage WMB; en carte; avec impression; 11 ... 20 (10x); non extensible; Impression horizontale; encliquetable</p>	<a href="http://www.wago.com/793-503/000-007">www.wago.com/793-503/000-007</a>
	<p><b>N° art.: 793-503/000-012</b> Carte de repérage WMB; en carte; avec impression; 11 ... 20 (10x); non extensible; Impression horizontale; encliquetable</p>	<a href="http://www.wago.com/793-503/000-012">www.wago.com/793-503/000-012</a>
	<p><b>N° art.: 793-503/000-017</b> Carte de repérage WMB; en carte; avec impression; 11 ... 20 (10x); non extensible; Impression horizontale; encliquetable</p>	<a href="http://www.wago.com/793-503/000-017">www.wago.com/793-503/000-017</a>
	<p><b>N° art.: 793-503/000-023</b> Carte de repérage WMB; en carte; avec impression; 11 ... 20 (10x); non extensible; Impression horizontale; encliquetable</p>	<a href="http://www.wago.com/793-503/000-023">www.wago.com/793-503/000-023</a>
	<p><b>N° art.: 793-503/000-024</b> Carte de repérage WMB; en carte; avec impression; 11 ... 20 (10x); non extensible; Impression horizontale; encliquetable</p>	<a href="http://www.wago.com/793-503/000-024">www.wago.com/793-503/000-024</a>
	<p><b>N° art.: 793-504</b> Carte de repérage WMB; en carte; avec impression; 21 ... 30 (10x); non extensible; Impression horizontale; encliquetable</p>	<a href="http://www.wago.com/793-504">www.wago.com/793-504</a>
	<p><b>N° art.: 793-504/000-002</b> Carte de repérage WMB; en carte; avec impression; 21 ... 30 (10x); non extensible; Impression horizontale; encliquetable</p>	<a href="http://www.wago.com/793-504/000-002">www.wago.com/793-504/000-002</a>
	<p><b>N° art.: 793-504/000-005</b> Carte de repérage WMB; en carte; avec impression; 21 ... 30 (10x); non extensible; Impression horizontale; encliquetable</p>	<a href="http://www.wago.com/793-504/000-005">www.wago.com/793-504/000-005</a>
	<p><b>N° art.: 793-504/000-006</b> Carte de repérage WMB; en carte; avec impression; 21 ... 30 (10x); non extensible; Impression horizontale; encliquetable</p>	<a href="http://www.wago.com/793-504/000-006">www.wago.com/793-504/000-006</a>
	<p><b>N° art.: 793-504/000-012</b> Carte de repérage WMB; en carte; avec impression; 21 ... 30 (10x); non extensible; Impression horizontale; encliquetable</p>	<a href="http://www.wago.com/793-504/000-012">www.wago.com/793-504/000-012</a>
	<p><b>N° art.: 793-504/000-017</b> Carte de repérage WMB; en carte; avec impression; 21 ... 30 (10x); non extensible; Impression horizontale; encliquetable</p>	<a href="http://www.wago.com/793-504/000-017">www.wago.com/793-504/000-017</a>
	<p><b>N° art.: 793-504/000-023</b> Carte de repérage WMB; en carte; avec impression; 21 ... 30 (10x); non extensible; Impression horizontale; encliquetable</p>	<a href="http://www.wago.com/793-504/000-023">www.wago.com/793-504/000-023</a>
	<p><b>N° art.: 793-505</b> Carte de repérage WMB; en carte; avec impression; 31 ... 40 (10x); non extensible; Impression horizontale; encliquetable</p>	<a href="http://www.wago.com/793-505">www.wago.com/793-505</a>
	<p><b>N° art.: 793-505/000-005</b> Carte de repérage WMB; en carte; avec impression; 31 ... 40 (10x); non extensible; Impression horizontale; encliquetable</p>	<a href="http://www.wago.com/793-505/000-005">www.wago.com/793-505/000-005</a>

	<p><b>N° art.: 793-505/000-006</b>                  Carte de repérage WMB; en carte; avec impression; 31 ... 40 (10x); non extensible; Impression horizontale; encliquetable</p>	<p><a href="http://www.wago.com/793-505/000-006">www.wago.com/793-505/000-006</a></p>
	<p><b>N° art.: 793-505/000-007</b>                  Carte de repérage WMB; en carte; avec impression; 31 ... 40 (10x); non extensible; Impression horizontale; encliquetable</p>	<p><a href="http://www.wago.com/793-505/000-007">www.wago.com/793-505/000-007</a></p>
	<p><b>N° art.: 793-505/000-012</b>                  Carte de repérage WMB; en carte; avec impression; 31 ... 40 (10x); non extensible; Impression horizontale; encliquetable</p>	<p><a href="http://www.wago.com/793-505/000-012">www.wago.com/793-505/000-012</a></p>
	<p><b>N° art.: 793-506</b>                  Carte de repérage WMB; en carte; avec impression; 41 ... 50 (10x); non extensible; Impression horizontale; encliquetable</p>	<p><a href="http://www.wago.com/793-506">www.wago.com/793-506</a></p>
	<p><b>N° art.: 793-506/000-005</b>                  Carte de repérage WMB; en carte; avec impression; 41 ... 50 (10x); non extensible; Impression horizontale; encliquetable</p>	<p><a href="http://www.wago.com/793-506/000-005">www.wago.com/793-506/000-005</a></p>
	<p><b>N° art.: 793-506/000-006</b>                  Carte de repérage WMB; en carte; avec impression; 41 ... 50 (10x); non extensible; Impression horizontale; encliquetable</p>	<p><a href="http://www.wago.com/793-506/000-006">www.wago.com/793-506/000-006</a></p>
	<p><b>N° art.: 793-506/000-012</b>                  Carte de repérage WMB; en carte; avec impression; 41 ... 50 (10x); non extensible; Impression horizontale; encliquetable</p>	<p><a href="http://www.wago.com/793-506/000-012">www.wago.com/793-506/000-012</a></p>
	<p><b>N° art.: 793-506/000-017</b>                  Carte de repérage WMB; en carte; avec impression; 41 ... 50 (10x); non extensible; Impression horizontale; encliquetable</p>	<p><a href="http://www.wago.com/793-506/000-017">www.wago.com/793-506/000-017</a></p>
	<p><b>N° art.: 793-5501</b>                  Carte de repérage WMB; en carte; largeur des bornes 5 - 17,5 mm; extensible 5 - 5,2 MM; vierge; encliquetable</p>	<p><a href="http://www.wago.com/793-5501">www.wago.com/793-5501</a></p>
	<p><b>N° art.: 793-5501/000-002</b>                  Carte de repérage WMB; en carte; largeur des bornes 5 - 17,5 mm; extensible 5 - 5,2 MM; vierge; encliquetable</p>	<p><a href="http://www.wago.com/793-5501/000-002">www.wago.com/793-5501/000-002</a></p>
	<p><b>N° art.: 793-5501/000-005</b>                  Carte de repérage WMB; en carte; extensible 5 - 5,2 MM; vierge; encliquetable</p>	<p><a href="http://www.wago.com/793-5501/000-005">www.wago.com/793-5501/000-005</a></p>
	<p><b>N° art.: 793-5501/000-006</b>                  Carte de repérage WMB; en carte; extensible 5 - 5,2 MM; vierge; encliquetable</p>	<p><a href="http://www.wago.com/793-5501/000-006">www.wago.com/793-5501/000-006</a></p>
	<p><b>N° art.: 793-5501/000-007</b>                  Carte de repérage WMB; en carte; extensible 5 - 5,2 MM; vierge; encliquetable</p>	<p><a href="http://www.wago.com/793-5501/000-007">www.wago.com/793-5501/000-007</a></p>
	<p><b>N° art.: 793-5501/000-012</b>                  Carte de repérage WMB; en carte; extensible 5 - 5,2 MM; vierge; encliquetable</p>	<p><a href="http://www.wago.com/793-5501/000-012">www.wago.com/793-5501/000-012</a></p>
	<p><b>N° art.: 793-5501/000-014</b>                  Carte de repérage WMB; en carte; extensible 5 - 5,2 MM; vierge; encliquetable</p>	<p><a href="http://www.wago.com/793-5501/000-014">www.wago.com/793-5501/000-014</a></p>





**N° art.: 793-5501/000-017**  
Carte de repérage WMB; en carte; extensible 5 - 5,2 MM; vierge; encliquetable

[www.wago.com/793-5501/000-017](http://www.wago.com/793-5501/000-017)



**N° art.: 793-5501/000-023**  
Carte de repérage WMB; en carte; extensible 5 - 5,2 MM; vierge; encliquetable

[www.wago.com/793-5501/000-023](http://www.wago.com/793-5501/000-023)



**N° art.: 793-5501/000-024**  
Carte de repérage WMB; en carte; extensible 5 - 5,2 MM; vierge; encliquetable

[www.wago.com/793-5501/000-024](http://www.wago.com/793-5501/000-024)



**N° art.: 793-566**  
Carte de repérage WMB; en carte; avec impression; 1 ... 50 (2x); non extensible; Impression horizontale; encliquetable

[www.wago.com/793-566](http://www.wago.com/793-566)



**N° art.: 793-566/000-002**  
Carte de repérage WMB; en carte; avec impression; 1 ... 50 (2x); non extensible; Impression horizontale; encliquetable

[www.wago.com/793-566/000-002](http://www.wago.com/793-566/000-002)



**N° art.: 793-566/000-005**  
Carte de repérage WMB; en carte; avec impression; 1 ... 50 (2x); non extensible; Impression horizontale; encliquetable

[www.wago.com/793-566/000-005](http://www.wago.com/793-566/000-005)



**N° art.: 793-566/000-006**  
Carte de repérage WMB; en carte; avec impression; 1 ... 50 (2x); non extensible; Impression horizontale; encliquetable

[www.wago.com/793-566/000-006](http://www.wago.com/793-566/000-006)



**N° art.: 793-566/000-007**  
Carte de repérage WMB; en carte; avec impression; 1 ... 50 (2x); non extensible; Impression horizontale; encliquetable

[www.wago.com/793-566/000-007](http://www.wago.com/793-566/000-007)



**N° art.: 793-566/000-012**  
Carte de repérage WMB; en carte; avec impression; 1 ... 50 (2x); non extensible; Impression horizontale; encliquetable

[www.wago.com/793-566/000-012](http://www.wago.com/793-566/000-012)



**N° art.: 793-566/000-017**  
Carte de repérage WMB; en carte; avec impression; 1 ... 50 (2x); non extensible; Impression horizontale; encliquetable

[www.wago.com/793-566/000-017](http://www.wago.com/793-566/000-017)



**N° art.: 793-566/000-023**  
Carte de repérage WMB; en carte; avec impression; 1 ... 50 (2x); non extensible; Impression horizontale; encliquetable

[www.wago.com/793-566/000-023](http://www.wago.com/793-566/000-023)



**N° art.: 793-566/000-024**  
Carte de repérage WMB; en carte; avec impression; 1 ... 50 (2x); non extensible; Impression horizontale; encliquetable

[www.wago.com/793-566/000-024](http://www.wago.com/793-566/000-024)

#### tools



**N° art.: 210-719**  
Outil de manipulation, partiellement isolé; Type 1, lame (2,5 x 0,4) mm







[www.wago.com/210-719](http://www.wago.com/210-719)

#### General accessories



**N° art.: 209-145**  
Porte-étiquettes de groupe

[www.wago.com/209-145](http://www.wago.com/209-145)

	<b>N° art.: 209-184</b> Protège-étiquettes	<a href="http://www.wago.com/209-184">www.wago.com/209-184</a>
	<b>N° art.: 249-105</b> Porte-étiquettes de groupe	<a href="http://www.wago.com/249-105">www.wago.com/249-105</a>
	<b>N° art.: 788-120</b> Accessoire pour module relais; Etat de fonctionnement rouge	<a href="http://www.wago.com/788-120">www.wago.com/788-120</a>
	<b>N° art.: 858-110</b> Étrier de maintien pour relais industriel (hauteur 33,5 mm à 35,5)	<a href="http://www.wago.com/858-110">www.wago.com/858-110</a>
	<b>N° art.: 858-150</b> Relais de couplage; Tension nominale d'entrée DC 24 V; 4 RT; Courant permanent limite 5 A; avec forçage manuel; largeur de module : 22 mm; Hauteur du relais 25 mm	<a href="http://www.wago.com/858-150">www.wago.com/858-150</a>
<b>Jumper</b>		
	<b>N° art.: 858-402</b> Peigne de pontage; pour le côté bobine	<a href="http://www.wago.com/858-402">www.wago.com/858-402</a>

## Téléchargements

### Documentation

#### Bid Text

858-304 Relaisbaustein	Jan 15, 2016	DOC 28,7 kB	Téléchargement
---------------------------	--------------	----------------	----------------

#### Instruction Leaflet

Sockets for Elementary Relays	Dec 9, 2016	PDF 2,6 MB	Téléchargement
-------------------------------	-------------	---------------	----------------

#### Additional Information

Disposal; Electrical and electronic equipment, Packaging	V 1.0.0 Oct 15, 2018	PDF 269,1 kB	Téléchargement
--	-------------------------	-----------------	----------------

## smartDATA

### CAD data

3D Download 858-304		URL	Téléchargement
---------------------	--	-----	----------------



Sous réserve de modifications.

---

WAGO Contact SAS  
Paris Nord 2 - 83 rue des Chardonnerets  
Tremblay-en-France  
BP 55065

95947 Roissy CDG Cedex

Téléphone : 01 48 17 25 90 | Fax : 01 48 63 25 20

E-mail : [info-fr@wago.com](mailto:info-fr@wago.com) | Web : [www.wago.fr](http://www.wago.fr)

Avez-vous des questions sur nos produits ?

Nous nous tenons volontiers à votre disposition au +49 (571) 887-44222.