

Fiche technique | Numéro d'article: 857-304

Module relais; Tension nominale d'entrée DC 24 V; 1 RT; Limitation courant constant 6 A; Indication d'état des capteurs/actionneurs jaune; Largeur 6 mm

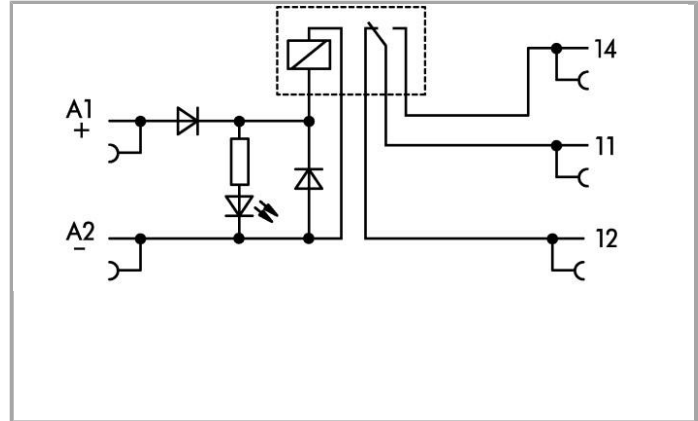

www.wago.com/857-304



RoHS Compliant

BOMcheck.net

Couleur:

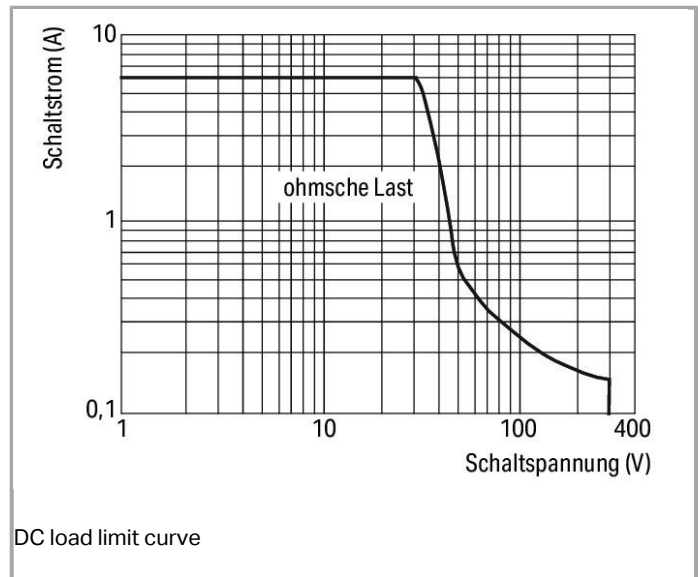
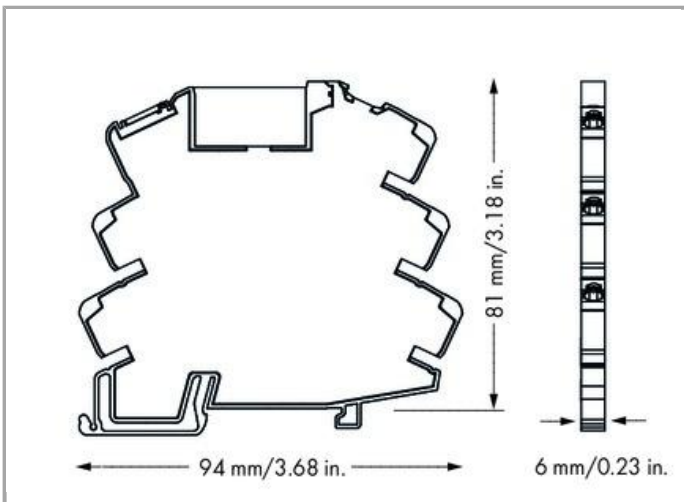



Description du produit :

Description :

Module relais avec relais miniature remplaçable pour la séparation galvanique entre les capteurs/actionneurs et la commande/API.

Les modules relais WAGO d'un pas de 6 mm ont un profil absolument identique. En outre, les dispositifs de pontage pour les tensions d'alimentation, etc. se trouvent toujours à la même position, il suffit alors d'utiliser les peignes de pontage pour une simplification du câblage. Si besoin, les relais enfichables peuvent être remplacés rapidement et simplement. En option, un adaptateur de câblage peut être enfiché du côté entrée ou sortie. Celui-ci permet le précâblage de 8 modules via un cordon câble plat.

L'état de commutation est indiqué par une LED jaune intégrée.

Le repérage des équipements peut être réalisé à l'aide du système de marquage multiple WMB de WAGO.

Note:

Remarque : Un dispositif d'antiparasitage approprié doit être installé parallèlement aux charges inductives.

Données

Données techniques

Circuit de commande

Nominal input voltage U_N	24 VDC
Input voltage range	-15 ... +20 %
Courant d'entrée nominal IN	10 mA

Circuit de charge

Nombre relais 1 T/contacts inverseurs	1
Contact material (relay)	AgSnO ₂
Limiting continuous current	6 A
Max. make current (resistive)	0,02 s 20 A (AC)
Max. switching voltage	250 VAC
Max. switching power (resistive)	1500 VAAC; DC see load limit curve
Switching capacity	AC-15: 3 A / 250 VAC; DC-13: 2 A / 24 VDC
Charge min. recommandée	10 V / 10 mA; 24 V / 1 mA
Temps de montée typ.	8 ms
Temps de relâchement	4 ms
Electrical life (N.O.; resistive load; 23 °C)	50 x 10 ³ switching operations
Mechanical life (N.O.; resistive load; 23 °C)	5 x 10 ⁶ switching operations
Max. switching load with load/without load	6 min ⁻¹ / 180 min ⁻¹

Signaling

Indication d'état	LED jaune
-------------------	-----------

Sécurité & Protection

Tension de référence	250 V
Tension assignée de tenue aux chocs	4 kV
Degré de pollution	2
Tension de claquage contact-bobine (AC, 1 min.)	4 kV _{rms}
Dielectric strength, control/load circuit (AC, 1 min)	4 kV _{rms}
Tension de claquage contact ouvert (AC, 1 min)	1 kV _{rms}
Dielectric strength open contact (AC, 1 min)	1 kV _{rms}
Indice de protection	IP20

Données de raccordement

Technique de connexion	Push-in CAGE CLAMP®
Conducteur rigide	0,34 ... 2,5 mm ² / 22 ... 14 AWG
Conducteur souple	0,34 ... 2,5 mm ² / 22 ... 14 AWG
Longueur de dénudage	9 ... 10 mm / 0.35 ... 0.39 inch

Données géométriques

Largeur	6 mm / 0.236 inch
Profondeur à partir du niveau supérieur du rail	81 mm / 3.189 inch
Profondeur	94 mm / 3.701 inch

Données mécaniques

Type de montage	Rail 35
-----------------	---------

Données du matériau

Couleur	gris
Charge calorifique	0.619 MJ
Poids	31.56 g

Conditions d'environnement

Température ambiante admissible Fonctionnement pour U _N	-40 ... 60 °C
Température ambiante (stockage)	-40 ... 70 °C
Processing temperature	-25 ... +50 °C
Degré de pollution	2

Normes et spécifications

Normes/spécifications	EN 61010-2-201; EN 61810-1; EN 61373; UL 508; GL, ATEX, IEC Ex
-----------------------	--

Elementary relay



WAGO elementary relay	857-152
-----------------------	---------

Dates commerciales

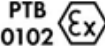

Country of origin	CN
GTIN	4050821797807
Customs Tariff No.	85364900990
Product Group	6 (Interface Electronics)

Autorisations / certificats

Ex-approbations

Logo	Approbation	Nom du certificat
	ATEX DEKRA EXAM GmbH	BVS_14_ATEX_E_091_X
	IECEX DEKRA EXAM GmbH	IECEX_BVS_14.0079_X
	UL UL International Germany GmbH (HAZARDOUS LOCATIONS)	E198726 Sec.4 (HAZARDOUS LOCATIONS)

Approbations de navire

Logo	Approbation	Nom du certificat
	BV Bureau Veritas S.A.	40179_A0
	DNV GL Det Norske Veritas, Germanischer Lloyd	TAA00001D1
	NK Nippon Kaiji Kyokai	TA17255M
	PRS	TE/1989/880590/13













Polski Rejestr Statkow

















Approbations UL















Logo	Approbation	Nom du certificat
	UL UL International Netherlands B.V. (ORDINARY LOCATIONS)	E175199 Sec.4 (ORDINARY LOCATIONS)



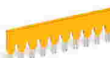













Produits correspondants















Jumper















	N° art.: 281-482 Peigne de pontage; isolé; 2 raccords; IN = IN borne	www.wago.com/281-482
	N° art.: 859-402 Peigne de pontage; 2 raccords; Courant nominal 18 A; isolé	www.wago.com/859-402
	N° art.: 859-402/000-005 Peigne de pontage; 2 raccords; Courant nominal 18 A; isolé	www.wago.com/859-402/000-005
	N° art.: 859-402/000-006 Peigne de pontage; 2 raccords; Courant nominal 18 A; isolé	www.wago.com/859-402/000-006
	N° art.: 859-402/000-029 Peigne de pontage; 2 raccords; Courant nominal 18 A; isolé	www.wago.com/859-402/000-029
	N° art.: 859-403 Peigne de pontage; 3 raccords; Courant nominal 18 A; isolé	www.wago.com/859-403
	N° art.: 859-403/000-005 Peigne de pontage; 3 raccords; Courant nominal 18 A; isolé	www.wago.com/859-403/000-005
	N° art.: 859-403/000-006 Peigne de pontage; 3 raccords; Courant nominal 18 A; isolé	www.wago.com/859-403/000-006
	N° art.: 859-403/000-029 Peigne de pontage; 3 raccords; Courant nominal 18 A; isolé	www.wago.com/859-403/000-029
	N° art.: 859-404 Peigne de pontage; 4 raccords; Courant nominal 18 A; isolé	www.wago.com/859-404
	N° art.: 859-404/000-005 Peigne de pontage; 4 raccords; Courant nominal 18 A; isolé	www.wago.com/859-404/000-005















	N° art.: 859-404/000-006 Peigne de pontage; 4 raccords; Courant nominal 18 A; isolé	www.wago.com/859-404/000-006
	N° art.: 859-404/000-029 Peigne de pontage; 4 raccords; Courant nominal 18 A; isolé	www.wago.com/859-404/000-029
	N° art.: 859-405 Peigne de pontage; 5 raccords; Courant nominal 18 A; isolé	www.wago.com/859-405
	N° art.: 859-405/000-005 Peigne de pontage; 5 raccords; Courant nominal 18 A; isolé	www.wago.com/859-405/000-005
	N° art.: 859-405/000-006 Peigne de pontage; 5 raccords; Courant nominal 18 A; isolé	www.wago.com/859-405/000-006
	N° art.: 859-405/000-029 Peigne de pontage; 5 raccords; Courant nominal 18 A; isolé	www.wago.com/859-405/000-029
	N° art.: 859-406 Peigne de pontage; 6 raccords; Courant nominal 18 A; isolé	www.wago.com/859-406
	N° art.: 859-406/000-005 Peigne de pontage; 6 raccords; Courant nominal 18 A; isolé	www.wago.com/859-406/000-005
	N° art.: 859-406/000-006 Peigne de pontage; 6 raccords; Courant nominal 18 A; isolé	www.wago.com/859-406/000-006
	N° art.: 859-406/000-029 Peigne de pontage; 6 raccords; Courant nominal 18 A; isolé	www.wago.com/859-406/000-029
	N° art.: 859-407 Peigne de pontage; 7 raccords; Courant nominal 18 A; isolé	www.wago.com/859-407
	N° art.: 859-407/000-005 Peigne de pontage; 7 raccords; Courant nominal 18 A; isolé	www.wago.com/859-407/000-005
	N° art.: 859-407/000-006 Peigne de pontage; 7 raccords; Courant nominal 18 A; isolé	www.wago.com/859-407/000-006
	N° art.: 859-407/000-029 Peigne de pontage; 7 raccords; Courant nominal 18 A; isolé	www.wago.com/859-407/000-029
	N° art.: 859-408 Peigne de pontage; 8 raccords; Courant nominal 18 A; isolé	www.wago.com/859-408
	N° art.: 859-408/000-005 Peigne de pontage; 8 raccords; Courant nominal 18 A; isolé	www.wago.com/859-408/000-005

	N° art.: 859-408/000-006 Peigne de pontage; 8 raccords; Courant nominal 18 A; isolé	www.wago.com/859-408/000-006
	N° art.: 859-408/000-029 Peigne de pontage; 8 raccords; Courant nominal 18 A; isolé	www.wago.com/859-408/000-029
	N° art.: 859-409 Peigne de pontage; 9 raccords; Courant nominal 18 A; isolé	www.wago.com/859-409
	N° art.: 859-409/000-005 Peigne de pontage; 9 raccords; Courant nominal 18 A; isolé	www.wago.com/859-409/000-005
	N° art.: 859-409/000-006 Peigne de pontage; 9 raccords; Courant nominal 18 A; isolé	www.wago.com/859-409/000-006
	N° art.: 859-409/000-029 Peigne de pontage; 9 raccords; Courant nominal 18 A; isolé	www.wago.com/859-409/000-029
	N° art.: 859-410 Peigne de pontage; 10 raccords; Courant nominal 18 A; isolé	www.wago.com/859-410
	N° art.: 859-410/000-005 Peigne de pontage; 10 raccords; Courant nominal 18 A; isolé	www.wago.com/859-410/000-005
	N° art.: 859-410/000-006 Peigne de pontage; 10 raccords; Courant nominal 18 A; isolé	www.wago.com/859-410/000-006
	N° art.: 859-410/000-029 Peigne de pontage; 10 raccords; Courant nominal 18 A; isolé	www.wago.com/859-410/000-029
Marking accessories		
	N° art.: 2009-110 Bandes de marquage; sur rouleau; non extensible; vierge; encliquetable	www.wago.com/2009-110
	N° art.: 2009-115 WMB-Inline; pour smartPRINTER; sur rouleau; extensible 5 - 5,2 MM; vierge; encliquetable	www.wago.com/2009-115
	N° art.: 2009-115/000-002 WMB-Inline; pour smartPRINTER; sur rouleau; extensible 5 - 5,2 MM; vierge; encliquetable	www.wago.com/2009-115/000-002
	N° art.: 2009-115/000-006 WMB-Inline; pour smartPRINTER; sur rouleau; extensible 5 - 5,2 MM; vierge; encliquetable	www.wago.com/2009-115/000-006
	N° art.: 2009-115/000-007 WMB-Inline; sur rouleau; extensible 5 - 5,2 MM; vierge; encliquetable	www.wago.com/2009-115/000-007

	<p>N° art.: 2009-115/000-012 WMB-Inline; pour smartPRINTER; sur rouleau; extensible 5 - 5,2 MM; vierge; encliquetable</p>	www.wago.com/2009-115/000-012
	<p>N° art.: 2009-115/000-017 WMB-Inline; sur rouleau; extensible 5 - 5,2 MM; vierge; encliquetable</p>	www.wago.com/2009-115/000-017
	<p>N° art.: 2009-115/000-023 WMB-Inline; pour smartPRINTER; sur rouleau; extensible 5 - 5,2 MM; vierge; encliquetable</p>	www.wago.com/2009-115/000-023
	<p>N° art.: 2009-115/000-024 WMB-Inline; pour smartPRINTER; sur rouleau; extensible 5 - 5,2 MM; vierge; encliquetable</p>	www.wago.com/2009-115/000-024
	<p>N° art.: 209-128 Adaptateur</p>	www.wago.com/209-128
	<p>N° art.: 209-183 Étiquette à enficher</p>	www.wago.com/209-183
	<p>N° art.: 210-110 Stylo feutre-graveur</p>	www.wago.com/210-110
	<p>N° art.: 793-501 Carte de repérage WMB; en carte; non extensible; vierge; encliquetable</p>	www.wago.com/793-501
	<p>N° art.: 793-501/000-002 Carte de repérage WMB; en carte; non extensible; vierge; encliquetable</p>	www.wago.com/793-501/000-002
	<p>N° art.: 793-501/000-005 Carte de repérage WMB; en carte; non extensible; vierge; encliquetable</p>	www.wago.com/793-501/000-005
	<p>N° art.: 793-501/000-006 Carte de repérage WMB; en carte; non extensible; vierge; encliquetable</p>	www.wago.com/793-501/000-006
	<p>N° art.: 793-501/000-007 Carte de repérage WMB; en carte; non extensible; vierge; encliquetable</p>	www.wago.com/793-501/000-007
	<p>N° art.: 793-501/000-012 Carte de repérage WMB; en carte; non extensible; vierge; encliquetable</p>	www.wago.com/793-501/000-012
	<p>N° art.: 793-501/000-017 Carte de repérage WMB; en carte; non extensible; vierge; encliquetable</p>	www.wago.com/793-501/000-017
	<p>N° art.: 793-501/000-023 Carte de repérage WMB; en carte; non extensible; vierge; encliquetable</p>	www.wago.com/793-501/000-023
	<p>N° art.: 793-501/000-024 Carte de repérage WMB; en carte; non extensible; vierge; encliquetable</p>	www.wago.com/793-501/000-024

	<p>N° art.: 793-502 Carte de repérage WMB; en carte; avec impression; 1 ... 10 (10x); non extensible; Impression horizontale; encliquetable</p>	www.wago.com/793-502
	<p>N° art.: 793-502/000-002 Carte de repérage WMB; en carte; avec impression; 1 ... 10 (10x); non extensible; Impression horizontale; encliquetable</p>	www.wago.com/793-502/000-002
	<p>N° art.: 793-502/000-005 Carte de repérage WMB; en carte; avec impression; 1 ... 10 (10x); non extensible; Impression horizontale; encliquetable</p>	www.wago.com/793-502/000-005
	<p>N° art.: 793-502/000-006 Carte de repérage WMB; en carte; avec impression; 1 ... 10 (10x); non extensible; Impression horizontale; encliquetable</p>	www.wago.com/793-502/000-006
	<p>N° art.: 793-502/000-007 Carte de repérage WMB; en carte; avec impression; 1 ... 10 (10x); non extensible; Impression horizontale; encliquetable</p>	www.wago.com/793-502/000-007
	<p>N° art.: 793-502/000-012 Carte de repérage WMB; en carte; avec impression; 1 ... 10 (10x); non extensible; Impression horizontale; encliquetable</p>	www.wago.com/793-502/000-012
	<p>N° art.: 793-502/000-017 Carte de repérage WMB; en carte; avec impression; 1 ... 10 (10x); non extensible; Impression horizontale; encliquetable</p>	www.wago.com/793-502/000-017
	<p>N° art.: 793-502/000-023 Carte de repérage WMB; en carte; avec impression; 1 ... 10 (10x); non extensible; Impression horizontale; encliquetable</p>	www.wago.com/793-502/000-023
	<p>N° art.: 793-502/000-024 Carte de repérage WMB; en carte; avec impression; 1 ... 10 (10x); non extensible; Impression horizontale; encliquetable</p>	www.wago.com/793-502/000-024
	<p>N° art.: 793-503 Carte de repérage WMB; en carte; avec impression; 11 ... 20 (10x); non extensible; Impression horizontale; encliquetable</p>	www.wago.com/793-503
	<p>N° art.: 793-503/000-002 Carte de repérage WMB; en carte; avec impression; 11 ... 20 (10x); non extensible; Impression horizontale; encliquetable</p>	www.wago.com/793-503/000-002
	<p>N° art.: 793-503/000-005 Carte de repérage WMB; en carte; avec impression; 11 ... 20 (10x); non extensible; Impression horizontale; encliquetable</p>	www.wago.com/793-503/000-005
	<p>N° art.: 793-503/000-006 Carte de repérage WMB; en carte; avec impression; 11 ... 20 (10x); non extensible; Impression horizontale; encliquetable</p>	www.wago.com/793-503/000-006
	<p>N° art.: 793-503/000-007 Carte de repérage WMB; en carte; avec impression; 11 ... 20 (10x); non extensible; Impression horizontale; encliquetable</p>	www.wago.com/793-503/000-007
	<p>N° art.: 793-503/000-012 Carte de repérage WMB; en carte; avec impression; 11 ... 20 (10x); non extensible; Impression horizontale; encliquetable</p>	www.wago.com/793-503/000-012

	<p>N° art.: 793-503/000-017 Carte de repérage WMB; en carte; avec impression; 11 ... 20 (10x); non extensible; Impression horizontale; encliquetable</p>	www.wago.com/793-503/000-017
	<p>N° art.: 793-503/000-023 Carte de repérage WMB; en carte; avec impression; 11 ... 20 (10x); non extensible; Impression horizontale; encliquetable</p>	www.wago.com/793-503/000-023
	<p>N° art.: 793-503/000-024 Carte de repérage WMB; en carte; avec impression; 11 ... 20 (10x); non extensible; Impression horizontale; encliquetable</p>	www.wago.com/793-503/000-024
	<p>N° art.: 793-504 Carte de repérage WMB; en carte; avec impression; 21 ... 30 (10x); non extensible; Impression horizontale; encliquetable</p>	www.wago.com/793-504
	<p>N° art.: 793-504/000-002 Carte de repérage WMB; en carte; avec impression; 21 ... 30 (10x); non extensible; Impression horizontale; encliquetable</p>	www.wago.com/793-504/000-002
	<p>N° art.: 793-504/000-005 Carte de repérage WMB; en carte; avec impression; 21 ... 30 (10x); non extensible; Impression horizontale; encliquetable</p>	www.wago.com/793-504/000-005
	<p>N° art.: 793-504/000-006 Carte de repérage WMB; en carte; avec impression; 21 ... 30 (10x); non extensible; Impression horizontale; encliquetable</p>	www.wago.com/793-504/000-006
	<p>N° art.: 793-504/000-012 Carte de repérage WMB; en carte; avec impression; 21 ... 30 (10x); non extensible; Impression horizontale; encliquetable</p>	www.wago.com/793-504/000-012
	<p>N° art.: 793-504/000-017 Carte de repérage WMB; en carte; avec impression; 21 ... 30 (10x); non extensible; Impression horizontale; encliquetable</p>	www.wago.com/793-504/000-017
	<p>N° art.: 793-504/000-023 Carte de repérage WMB; en carte; avec impression; 21 ... 30 (10x); non extensible; Impression horizontale; encliquetable</p>	www.wago.com/793-504/000-023
	<p>N° art.: 793-505 Carte de repérage WMB; en carte; avec impression; 31 ... 40 (10x); non extensible; Impression horizontale; encliquetable</p>	www.wago.com/793-505
	<p>N° art.: 793-505/000-005 Carte de repérage WMB; en carte; avec impression; 31 ... 40 (10x); non extensible; Impression horizontale; encliquetable</p>	www.wago.com/793-505/000-005
	<p>N° art.: 793-505/000-006 Carte de repérage WMB; en carte; avec impression; 31 ... 40 (10x); non extensible; Impression horizontale; encliquetable</p>	www.wago.com/793-505/000-006
	<p>N° art.: 793-505/000-007 Carte de repérage WMB; en carte; avec impression; 31 ... 40 (10x); non extensible; Impression horizontale; encliquetable</p>	www.wago.com/793-505/000-007
	<p>N° art.: 793-505/000-012 Carte de repérage WMB; en carte; avec impression; 31 ... 40 (10x); non extensible; Impression horizontale; encliquetable</p>	www.wago.com/793-505/000-012

	<p>N° art.: 793-506 Carte de repérage WMB; en carte; avec impression; 41 ... 50 (10x); non extensible; Impression horizontale; encliquetable</p>	www.wago.com/793-506
	<p>N° art.: 793-506/000-005 Carte de repérage WMB; en carte; avec impression; 41 ... 50 (10x); non extensible; Impression horizontale; encliquetable</p>	www.wago.com/793-506/000-005
	<p>N° art.: 793-506/000-006 Carte de repérage WMB; en carte; avec impression; 41 ... 50 (10x); non extensible; Impression horizontale; encliquetable</p>	www.wago.com/793-506/000-006
	<p>N° art.: 793-506/000-012 Carte de repérage WMB; en carte; avec impression; 41 ... 50 (10x); non extensible; Impression horizontale; encliquetable</p>	www.wago.com/793-506/000-012
	<p>N° art.: 793-506/000-017 Carte de repérage WMB; en carte; avec impression; 41 ... 50 (10x); non extensible; Impression horizontale; encliquetable</p>	www.wago.com/793-506/000-017
	<p>N° art.: 793-5501 Carte de repérage WMB; en carte; largeur des bornes 5 - 17,5 mm; extensible 5 - 5,2 MM; vierge; encliquetable</p>	www.wago.com/793-5501
	<p>N° art.: 793-5501/000-002 Carte de repérage WMB; en carte; largeur des bornes 5 - 17,5 mm; extensible 5 - 5,2 MM; vierge; encliquetable</p>	www.wago.com/793-5501/000-002
	<p>N° art.: 793-5501/000-005 Carte de repérage WMB; en carte; extensible 5 - 5,2 MM; vierge; encliquetable</p>	www.wago.com/793-5501/000-005
	<p>N° art.: 793-5501/000-006 Carte de repérage WMB; en carte; extensible 5 - 5,2 MM; vierge; encliquetable</p>	www.wago.com/793-5501/000-006
	<p>N° art.: 793-5501/000-007 Carte de repérage WMB; en carte; extensible 5 - 5,2 MM; vierge; encliquetable</p>	www.wago.com/793-5501/000-007
	<p>N° art.: 793-5501/000-012 Carte de repérage WMB; en carte; extensible 5 - 5,2 MM; vierge; encliquetable</p>	www.wago.com/793-5501/000-012
	<p>N° art.: 793-5501/000-014 Carte de repérage WMB; en carte; extensible 5 - 5,2 MM; vierge; encliquetable</p>	www.wago.com/793-5501/000-014
	<p>N° art.: 793-5501/000-017 Carte de repérage WMB; en carte; extensible 5 - 5,2 MM; vierge; encliquetable</p>	www.wago.com/793-5501/000-017
	<p>N° art.: 793-5501/000-023 Carte de repérage WMB; en carte; extensible 5 - 5,2 MM; vierge; encliquetable</p>	www.wago.com/793-5501/000-023
	<p>N° art.: 793-5501/000-024 Carte de repérage WMB; en carte; extensible 5 - 5,2 MM; vierge; encliquetable</p>	www.wago.com/793-5501/000-024

**N° art.: 793-566**

Carte de repérage WMB; en carte; avec impression; 1 ... 50 (2x); non extensible; Impression horizontale; encliquetable www.wago.com/793-566

**N° art.: 793-566/000-002**

Carte de repérage WMB; en carte; avec impression; 1 ... 50 (2x); non extensible; Impression horizontale; encliquetable www.wago.com/793-566/000-002

**N° art.: 793-566/000-005**

Carte de repérage WMB; en carte; avec impression; 1 ... 50 (2x); non extensible; Impression horizontale; encliquetable www.wago.com/793-566/000-005

**N° art.: 793-566/000-006**

Carte de repérage WMB; en carte; avec impression; 1 ... 50 (2x); non extensible; Impression horizontale; encliquetable www.wago.com/793-566/000-006

**N° art.: 793-566/000-007**

Carte de repérage WMB; en carte; avec impression; 1 ... 50 (2x); non extensible; Impression horizontale; encliquetable www.wago.com/793-566/000-007

**N° art.: 793-566/000-012**

Carte de repérage WMB; en carte; avec impression; 1 ... 50 (2x); non extensible; Impression horizontale; encliquetable www.wago.com/793-566/000-012

**N° art.: 793-566/000-017**

Carte de repérage WMB; en carte; avec impression; 1 ... 50 (2x); non extensible; Impression horizontale; encliquetable www.wago.com/793-566/000-017

**N° art.: 793-566/000-023**

Carte de repérage WMB; en carte; avec impression; 1 ... 50 (2x); non extensible; Impression horizontale; encliquetable www.wago.com/793-566/000-023

**N° art.: 793-566/000-024**

Carte de repérage WMB; en carte; avec impression; 1 ... 50 (2x); non extensible; Impression horizontale; encliquetable www.wago.com/793-566/000-024

ferrule**N° art.: 216-241**

Embout d'extrémité; embout pour 0,5 mm² / AWG 22; avec isolation plastique; étamés par électrolyse; Cuivre électrolytique; serti de manière étanche aux gaz; selon DIN 46228, partie 4/09.90 www.wago.com/216-241

**N° art.: 216-242**

Embout d'extrémité; embout pour 0,75 mm² / AWG 20; avec isolation plastique; étamés par électrolyse; Cuivre électrolytique; serti de manière étanche aux gaz; selon DIN 46228, partie 4/09.90 www.wago.com/216-242

**N° art.: 216-243**

Embout d'extrémité; embout pour 1 mm² / AWG 18; avec isolation plastique; étamés par électrolyse; Cuivre électrolytique; serti de manière étanche aux gaz; selon DIN 46228, partie 4/09.90 www.wago.com/216-243

**N° art.: 216-244**

Embout d'extrémité; embout pour 1,5 mm² / AWG 16; avec isolation plastique; étamés par électrolyse; Cuivre électrolytique; serti de manière étanche aux gaz; selon DIN 46228, partie 4/09.90 www.wago.com/216-244

transfer module**N° art.: 857-981**

Adaptateur d'interface; 14 pôles; Entrée à commutation positive www.wago.com/857-981

N° art.: 857-982

Adaptateur d'interface; 14 pôles; Sortie à commutation positive www.wago.com/857-982



N° art.: 857-986
Adaptateur d'interface; 15 pôles; Entrée à commutation positive

www.wago.com/857-986

tools



N° art.: 210-720
Outil de manipulation, partiellement isolé; Type 2, lame (3,5 x 0,5) mm

www.wago.com/210-720

General accessories



N° art.: 209-184
Protège-étiquettes

www.wago.com/209-184



N° art.: 249-105
Porte-étiquettes de groupe

www.wago.com/249-105



N° art.: 857-152
Relais de couplage; Tension nominale d'entrée DC 24 V; 1 RT; Limitation courant constant 6 A; Largeur 5 mm; Hauteur du relais 15 mm

www.wago.com/857-152

Téléchargements

Documentation

Bid Text

857-304 Relaisbaustein	Apr 5, 2012	DOC 22,0 kB	Téléchargement
---------------------------	-------------	----------------	----------------

Instruction Leaflet

Sockets, relay module, optocoupler module Nominal input voltage 24 VDC, switching current 0.1 A	Jul 7, 2016	PDF 2,4 MB	Téléchargement
--	-------------	---------------	----------------

Additional Information

Disposal; Electrical and electronic equipment, Packaging	V 1.0.0 Oct 15, 2018	PDF 269,1 kB	Téléchargement
--	-------------------------	-----------------	----------------

smartDATA

CAD data

3D Download 857-304		URL	Téléchargement
Step file 857-03xx Series	1.0 Jun 30, 2011	STP 299,3 kB	Téléchargement



Sous réserve de modifications.

WAGO Contact SAS
Paris Nord 2 - 83 rue des Chardonnerets
Tremblay-en-France
BP 55065

95947 Roissy CDG Cedex
Téléphone : 01 48 17 25 90 | Fax : 01 48 63 25 20
E-mail : info-fr@wago.com | Web : www.wago.fr

Avez-vous des questions sur nos produits ?

Nous nous tenons volontiers à votre disposition au +49 (571) 887-44222.