

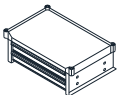

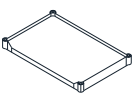



TOOLCRAFT

MONTAGEANLEITUNG / ASSEMBLY INSTRUCTIONS / NOTICE DE MONTAGE / OPZETTENDE INSTRUCTIE

Best. Nr. / Item No. / N° de commande / Bestnr. 55 39 41

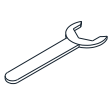
A	B	C	D	E	F	G
						
1 x	1 x	2 x	4 x	2 x	2 x	1 x

1

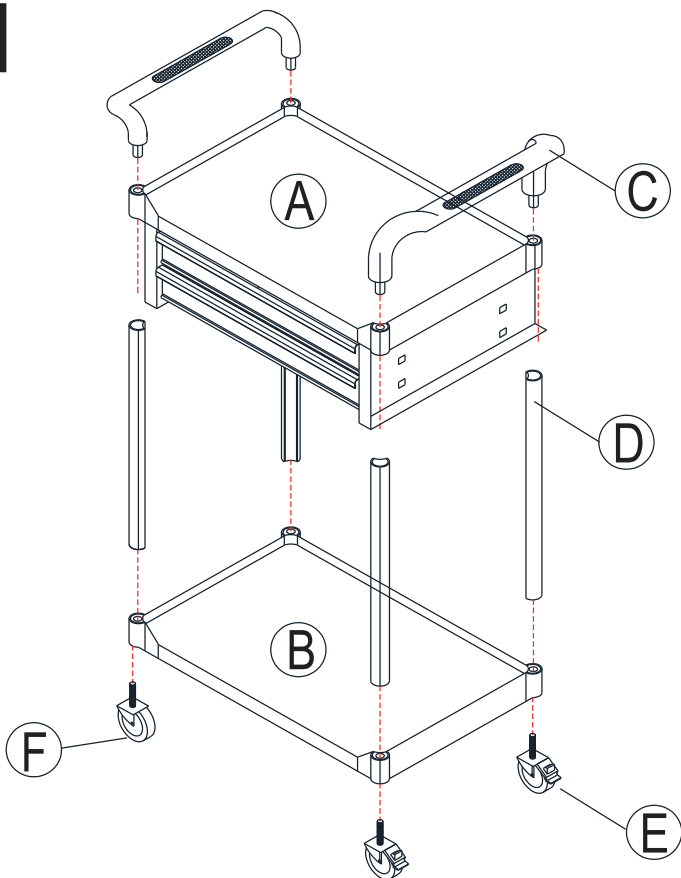

2

