

Fiche technique | Numéro d'article: 2010-1202

Borne de passage pour 2 conducteurs; 10 mm²; pour applications Ex e II;
Marquage latéral et central; Pour rail 35 x 15 et 35 x 7,5; Push-in CAGE
CLAMP®

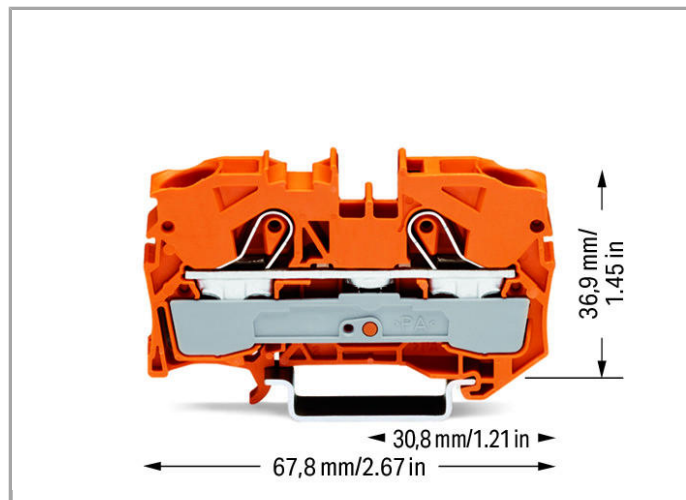

www.wago.com/2010-1202

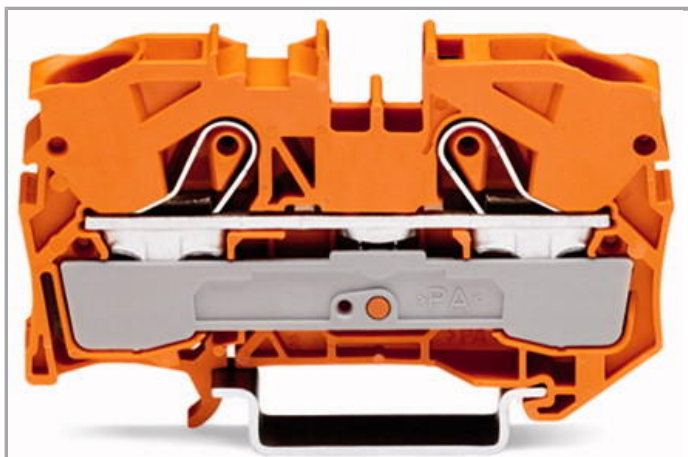

RoHS Compliant

BOMcheck.net

Couleur: ■

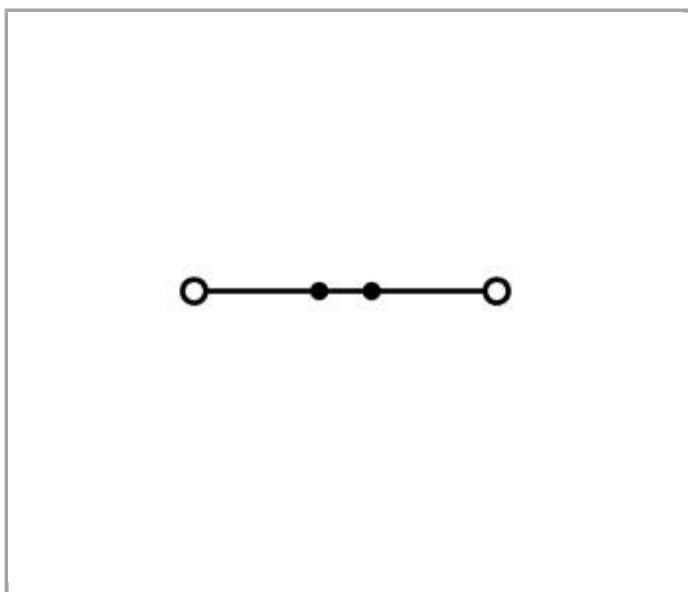

Données

Données électriques

Tension de référence EN (Ex e II)

550 V

Courant de référence (Ex e II)

51 A

Ratings per IEC/EN 60664-1

Tension de référence (III / 3)	800 V
Tension assignée de tenue aux chocs (III / 3)	8 kV
Courant	57 A
Courant de référence 2	76 A
Légende Données de référence	(III / 3) ≙ Catégorie de surtension III / degré de pollution 3

Approvals per UL 1059

Tension de référence UL (Use Group B)	600 V
Courant de référence UL (Use Group B)	65 A
Tension de référence UL (Use Group C)	600 V
Courant de référence UL (Use Group C)	65 A

Approvals per CSA

Tension de référence CSA (Use Group B)	600 V
Courant de référence CSA (Use Group B)	65 A
Tension de référence CSA (Use Group C)	600 V
Courant de référence CSA (Use Group C)	65 A

Données de raccordement

Technique de connexion	Push-in CAGE CLAMP®
Type d'actionnement	Push-in Outil de manipulation
Matière plastique conducteur raccordable	Cuivre
Section nominale :	10 mm ²
Conducteur rigide	0,5 ... 16 mm ² / 20 ... 6 AWG
Conducteur rigide, enfichage direct	4 ... 16 mm ² / 14 ... 6 AWG
Conducteur souple	0,5 ... 16 mm ² / 20 ... 6 AWG
conducteur souple avec embout d'extrémité, directement enfichable à partir de	4 mm ² / 14 AWG
Longueur de dénudage	17 ... 19 mm / 0.67 ... 0.75 inch
Nombre total des points de serrage	2
Nombre total des potentiels	1
nombre des niveaux	1
Type de câblage	câblage frontal

Données géométriques

Largeur	10 mm / 0.394 inch
Profondeur à partir du niveau supérieur du rail	36,9 mm / 1.453 inch
Profondeur	67,8 mm / 2.669 inch

Données mécaniques

Mode de construction	type horizontal
Type de montage	Rail 35
Niveau de marquage	Marquage central/latéral

Données du matériau



Couleur	orange
Matière isolante	Polyamide 66 (PA 66)
Charge calorifique	0.273 MJ
Poids	17.246 g

Dates commerciales

Country of origin	DE
GTIN	4017332076111
Customs Tariff No.	85369010000
Product Group	22 (TOPJOB S)

Autorisations / certificats

Ex-approbations

Logo	Approbation	Nom du certificat
	AEx UL International Germany GmbH c/o Physikalisch Technische Bundesanstalt	E185892 sec.21
	ATEX Physikalisch Technische Bundesanstalt (PTB)	PTB 05 ATEX 1070 U (II 2 G Ex eII bzw. I M2 Ex eI)
	IECEX Physikalisch Technische Bundesanstalt (PTB)	IECEX PTB 06.0003 U (Ex e IIC Gb and Ex e I Mb)

Approbations spécifiques au pays



Logo	Approbation	Nom du certificat
	CCA DEKRA Certification B.V.	NTR NL-7089
	CCA DEKRA Certification B.V.	2160584.11



CSA
DEKRA Certification B.V.

70111238

Approbations de navire

Logo	Approbation	Nom du certificat
	ABS American Bureau of Shipping	14-HG1293677-PDA
	BV Bureau Veritas S.A.	38586/A0 BV
	LR Lloyds Register	91/20112 (E9)

Approbations UL



Logo	Approbation	Nom du certificat
	UL UL International Germany GmbH	E45172











Produits correspondants

















End plate

	N° art.: 2010-1291 Plaque d'extrémité et intermédiaire; épaisseur 1 mm	www.wago.com/2010-1291
	N° art.: 2010-1292 Plaque d'extrémité et intermédiaire; épaisseur 1 mm	www.wago.com/2010-1292
	N° art.: 209-191 Séparateur Ex e/Ex i; épaisseur 3 mm; Largeur 120 mm	www.wago.com/209-191

Marking accessories

	N° art.: 2009-110 Bandes de marquage; sur rouleau; non extensible; vierge; encliquetable	www.wago.com/2009-110
	N° art.: 2009-115 WMB-Inline; pour smartPRINTER; sur rouleau; extensible 5 - 5,2 MM; vierge; encliquetable	www.wago.com/2009-115
	N° art.: 2009-115/000-002 WMB-Inline; pour smartPRINTER; sur rouleau; extensible 5 - 5,2 MM; vierge; encliquetable	www.wago.com/2009-115/000-002

	N° art.: 2009-115/000-006 WMB-Inline; pour smartPRINTER; sur rouleau; extensible 5 - 5,2 MM; vierge; encliquetable	www.wago.com/2009-115/000-006
	N° art.: 2009-115/000-007 WMB-Inline; sur rouleau; extensible 5 - 5,2 MM; vierge; encliquetable	www.wago.com/2009-115/000-007
	N° art.: 2009-115/000-012 WMB-Inline; pour smartPRINTER; sur rouleau; extensible 5 - 5,2 MM; vierge; encliquetable	www.wago.com/2009-115/000-012
	N° art.: 2009-115/000-017 WMB-Inline; sur rouleau; extensible 5 - 5,2 MM; vierge; encliquetable	www.wago.com/2009-115/000-017
	N° art.: 2009-115/000-023 WMB-Inline; pour smartPRINTER; sur rouleau; extensible 5 - 5,2 MM; vierge; encliquetable	www.wago.com/2009-115/000-023
	N° art.: 2009-115/000-024 WMB-Inline; pour smartPRINTER; sur rouleau; extensible 5 - 5,2 MM; vierge; encliquetable	www.wago.com/2009-115/000-024
	N° art.: 2009-145 Mini-WSB Inline; pour smartPRINTER; sur rouleau; extensible 5 - 5,2 MM; vierge; encliquetable	www.wago.com/2009-145
	N° art.: 2009-145/000-002 Mini-WSB Inline; sur rouleau; extensible 5 - 5,2 MM; vierge; encliquetable	www.wago.com/2009-145/000-002
	N° art.: 2009-145/000-005 Mini-WSB Inline; vierge; 1700 étiquettes Mini-WSB (5 mm) sur rouleau; extensible 5 - 5,2 MM	www.wago.com/2009-145/000-005
	N° art.: 2009-145/000-006 Mini-WSB Inline; pour smartPRINTER; sur rouleau; extensible 5 - 5,2 MM; vierge; encliquetable	www.wago.com/2009-145/000-006
	N° art.: 2009-145/000-007 Mini-WSB Inline; vierge; 1700 étiquettes Mini-WSB (5 mm) sur rouleau; extensible 5 - 5,2 MM	www.wago.com/2009-145/000-007
	N° art.: 2009-145/000-012 Mini-WSB Inline; pour smartPRINTER; sur rouleau; extensible 5 - 5,2 MM; vierge; encliquetable	www.wago.com/2009-145/000-012
	N° art.: 2009-145/000-023 Mini-WSB Inline; sur rouleau; extensible 5 - 5,2 MM; vierge; encliquetable	www.wago.com/2009-145/000-023
	N° art.: 2009-145/000-024 Mini-WSB Inline; sur rouleau; extensible 5 - 5,2 MM; vierge; encliquetable	www.wago.com/2009-145/000-024
	N° art.: 2009-191 Porte-étiquettes de groupe	www.wago.com/2009-191
	N° art.: 2009-192	

	Porte-étiquettes de groupe	www.wago.com/2009-192
	N° art.: 2009-193 Porte-étiquettes de groupe	www.wago.com/2009-193
	N° art.: 2009-198 Adaptateur	www.wago.com/2009-198
	N° art.: 248-501 Système de repérage rapide Mini-WSB; vierge; Largeur d'étiquettes 5 mm; 10 bandes à 10 étiquettes par carte	www.wago.com/248-501
	N° art.: 248-501/000-002 Carte de repérage mini WSB; en carte; non extensible; vierge; encliquetable	www.wago.com/248-501/000-002
	N° art.: 248-501/000-005 Carte de repérage mini WSB; en carte; vierge; encliquetable	www.wago.com/248-501/000-005
	N° art.: 248-501/000-006 Carte de repérage mini WSB; en carte; non extensible; vierge; encliquetable	www.wago.com/248-501/000-006
	N° art.: 248-501/000-007 Carte de repérage mini WSB; en carte; non extensible; vierge; encliquetable	www.wago.com/248-501/000-007
	N° art.: 248-501/000-012 Carte de repérage mini WSB; en carte; non extensible; vierge; encliquetable	www.wago.com/248-501/000-012
	N° art.: 248-501/000-017 Carte de repérage mini WSB; en carte; non extensible; vierge; encliquetable	www.wago.com/248-501/000-017
	N° art.: 248-501/000-023 Carte de repérage mini WSB; en carte; non extensible; vierge; encliquetable	www.wago.com/248-501/000-023
	N° art.: 248-501/000-024 Carte de repérage mini WSB; en carte; non extensible; vierge; encliquetable	www.wago.com/248-501/000-024
	N° art.: 793-501 Carte de repérage WMB; en carte; non extensible; vierge; encliquetable	www.wago.com/793-501
	N° art.: 793-501/000-002 Carte de repérage WMB; en carte; non extensible; vierge; encliquetable	www.wago.com/793-501/000-002
	N° art.: 793-501/000-005 Carte de repérage WMB; en carte; non extensible; vierge; encliquetable	www.wago.com/793-501/000-005
	N° art.: 793-501/000-006 Carte de repérage WMB; en carte; non extensible; vierge; encliquetable	www.wago.com/793-501/000-006



N° art.: 793-501/000-007
Carte de repérage WMB; en carte; non extensible; vierge; encliquetable

www.wago.com/793-501/000-007



N° art.: 793-501/000-012
Carte de repérage WMB; en carte; non extensible; vierge; encliquetable

www.wago.com/793-501/000-012



N° art.: 793-501/000-017
Carte de repérage WMB; en carte; non extensible; vierge; encliquetable

www.wago.com/793-501/000-017



N° art.: 793-501/000-023
Carte de repérage WMB; en carte; non extensible; vierge; encliquetable

www.wago.com/793-501/000-023



N° art.: 793-501/000-024
Carte de repérage WMB; en carte; non extensible; vierge; encliquetable

www.wago.com/793-501/000-024



N° art.: 793-5501
Carte de repérage WMB; en carte; largeur des bornes 5 - 17,5 mm; extensible 5 - 5,2 MM; vierge; encliquetable

www.wago.com/793-5501



N° art.: 793-5501/000-002
Carte de repérage WMB; en carte; largeur des bornes 5 - 17,5 mm; extensible 5 - 5,2 MM; vierge; encliquetable

www.wago.com/793-5501/000-002



N° art.: 793-5501/000-005
Carte de repérage WMB; en carte; extensible 5 - 5,2 MM; vierge; encliquetable

www.wago.com/793-5501/000-005



N° art.: 793-5501/000-006
Carte de repérage WMB; en carte; extensible 5 - 5,2 MM; vierge; encliquetable

www.wago.com/793-5501/000-006



N° art.: 793-5501/000-007
Carte de repérage WMB; en carte; extensible 5 - 5,2 MM; vierge; encliquetable

www.wago.com/793-5501/000-007



N° art.: 793-5501/000-012
Carte de repérage WMB; en carte; extensible 5 - 5,2 MM; vierge; encliquetable

www.wago.com/793-5501/000-012



N° art.: 793-5501/000-017
Carte de repérage WMB; en carte; extensible 5 - 5,2 MM; vierge; encliquetable

www.wago.com/793-5501/000-017



N° art.: 793-5501/000-023
Carte de repérage WMB; en carte; extensible 5 - 5,2 MM; vierge; encliquetable

www.wago.com/793-5501/000-023



N° art.: 793-5501/000-024
Carte de repérage WMB; en carte; extensible 5 - 5,2 MM; vierge; encliquetable

www.wago.com/793-5501/000-024

General accessories

N° art.: 2010-100



Couverture protectrice des doigts; sert de protection contre le contact accidentel des points de serrage sans conduit

www.wago.com/2010-100

check



N° art.: 2009-174

Adaptateur de test; pour fiche de test Ø 4 mm; pour tester les bornes sur rail TOPJOB®S

www.wago.com/2009-174



N° art.: 2009-182

Prise de test; pour max. 2,5 mm²; pour le raccordement sans outil des conducteurs de contrôle individuels de 0,08

www.wago.com/2009-182



N° art.: 2010-511

Connecteur modulaire TOPJOB® S; modulaires; pour fentes de pontage; 1 pôle

www.wago.com/2010-511



N° art.: 2010-549

Module vide; modulaires; pour sauter p.ex. des bornes pontées

www.wago.com/2010-549

tools



N° art.: 210-721

Outil de manipulation, partiellement isolé; Type 3, lame (5,5 x 0,8) mm

www.wago.com/210-721

Carrier rail



N° art.: 210-113

Rail acier; 35 x 7,5; épaisseur 1 mm; longueur 2 m; non perforé; d'après EN 60715

www.wago.com/210-113



N° art.: 210-114

Rail acier; 35 x 15; épaisseur 1,5 mm; longueur 2 m; non perforé; d'après EN 60715

www.wago.com/210-114



N° art.: 210-118

Rail acier; 35 x 15; épaisseur 2,3 mm; longueur 2 m; non perforé; d'après EN 60715

www.wago.com/210-118

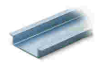

N° art.: 210-196

Rail aluminium; 35 x 8,2; épaisseur 1,6 mm; longueur 2 m; non perforé; d'après EN 60715

www.wago.com/210-196



N° art.: 210-197

Rail acier; 35 x 15; épaisseur 1,5 mm; longueur 2 m; perforé; d'après EN 60715

www.wago.com/210-197



N° art.: 210-198

Rail en cuivre; 35 x 15; épaisseur 2,3 mm; longueur 2 m; non perforé; d'après EN 60715

www.wago.com/210-198

Jumper



N° art.: 2010-402

Peigne de pontage; isolé; 2 raccords; Courant nominal 57 A

www.wago.com/2010-402



N° art.: 2010-403

Peigne de pontage; isolé; 3 raccords; Courant nominal 57 A

www.wago.com/2010-403



N° art.: 2010-404

Peigne de pontage; isolé; 4 raccords; Courant nominal 57 A















www.wago.com/2010-404

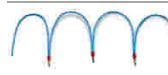

N° art.: 2010-405

Peigne de pontage; isolé; 5 raccords; Courant nominal 57 A

www.wago.com/2010-405

	N° art.: 2010-405/011-000 Contact de pontage en étoile; isolé; 3 pôles (1-3-5); IN = IN borne	www.wago.com/2010-405/011-000
	N° art.: 2010-433 Peigne de pontage; isolé; de 1 à 3; Courant nominal 57 A	www.wago.com/2010-433
	N° art.: 2010-434 Peigne de pontage; isolé; de 1 à 4; Courant nominal 57 A	www.wago.com/2010-434
	N° art.: 2010-435 Peigne de pontage; isolé; de 1 à 5; Courant nominal 57 A	www.wago.com/2010-435
	N° art.: 2016-499 Contact de pontage réducteur; isolé; de 16/10 mm ² à 10/6/4/2,5 mm ² ; Courant nominal 57 A	www.wago.com/2016-499
	N° art.: 210-103 Chaîne de pontage en fil; isolé; 50 raccords	www.wago.com/210-103
	N° art.: 210-123 Chaîne de pontage en fil; isolé; 50 raccords	www.wago.com/210-123
	N° art.: 285-430 Contact de pontage réducteur; isolé; de 285-13x sur bornes TOPJOB®S des séries 2010 et 2016; Courant nominal 90 A	www.wago.com/285-430
ferrule		
	N° art.: 216-284 Embout d'extrémité; embout pour 1,5 mm ² / AWG 16; avec isolation plastique; étamés par électrolyse; Cuivre électrolytique; serti de manière étanche aux gaz; selon DIN 46228, partie 4/09.90	www.wago.com/216-284
	N° art.: 216-286 Embout d'extrémité; embout pour 2,5 mm ² / AWG 14; avec isolation plastique; étamés par électrolyse; Cuivre électrolytique; serti de manière étanche aux gaz; selon DIN 46228, partie 4/09.90	www.wago.com/216-286
	N° art.: 216-287 Embout d'extrémité; embout pour 4 mm ² / AWG 12; avec isolation plastique; étamés par électrolyse; Cuivre électrolytique; serti de manière étanche aux gaz; selon DIN 46228, partie 4/09.90	www.wago.com/216-287
	N° art.: 216-288 Embout d'extrémité; embout pour 6 mm ² / AWG 10; avec isolation plastique; étamés par électrolyse; Cuivre électrolytique; serti de manière étanche aux gaz; selon DIN 46228, partie 4/09.90	www.wago.com/216-288
	N° art.: 216-289 Embout d'extrémité; embout pour 10 mm ² / AWG 8; avec isolation plastique; étamés par électrolyse; Cuivre électrolytique; serti de manière étanche aux gaz; selon DIN 46228, partie 4/09.90	www.wago.com/216-289
Protective Warning Marker		
	N° art.: 2010-115 Obtrateur de protection avec signalisation de danger; avec signalisation de danger; pour 5 bornes	www.wago.com/2010-115
	N° art.: 2016-115 Obturateur de protection avec signalisation de danger; avec signalisation de danger; pour 5 bornes	www.wago.com/2016-115



Téléchargements

Documentation

Bid Text

2010-1202	Aug 13, 2018	DOCX	Téléchargement
Reihenklemmen, TOPJOB S		15,0 kB	

smartDATA

CAD data

3D Download 2010-1202		URL	Téléchargement
-----------------------	--	-----	----------------

Sous réserve de modifications.