

# Fiche technique | Numéro d'article: 788-721

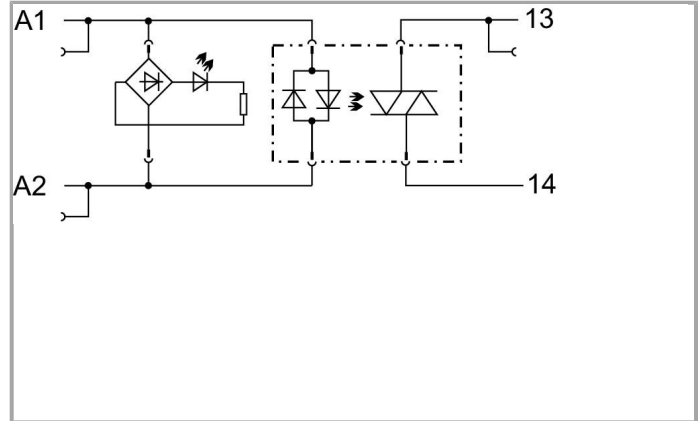

Module relais statique; Tension nominale d'entrée AC/DC 24 V; Plage de tension de sortie AC 24 ... 230 V; Limitation courant constant 4 A; raccordement 2 conducteurs; à commutation lors du passage par zéro; Indication d'état rouge; Largeur 15 mm

[www.wago.com/788-721](http://www.wago.com/788-721)

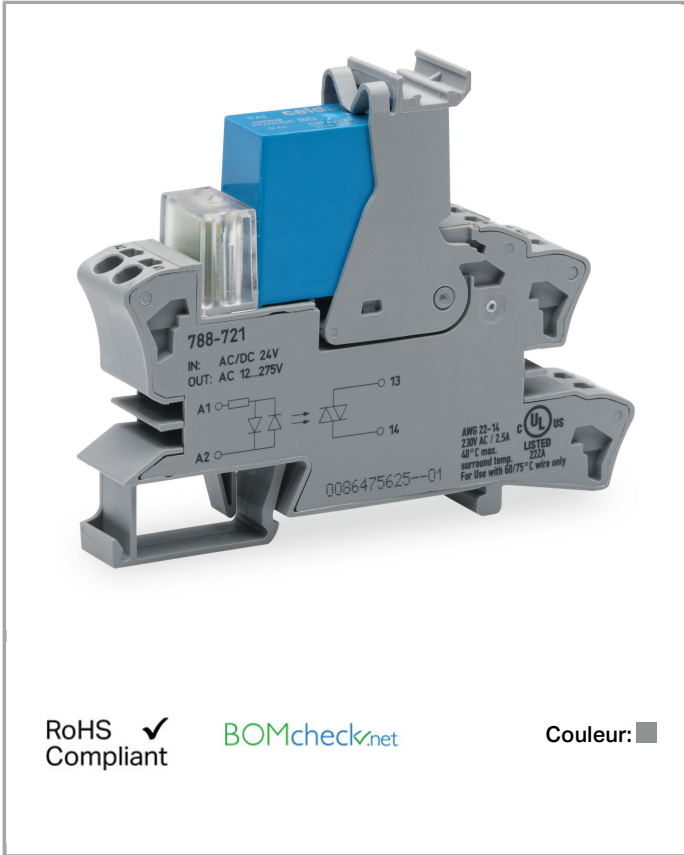

RoHS  Compliant

[BOMcheck.net](http://BOMcheck.net)

Couleur: ■

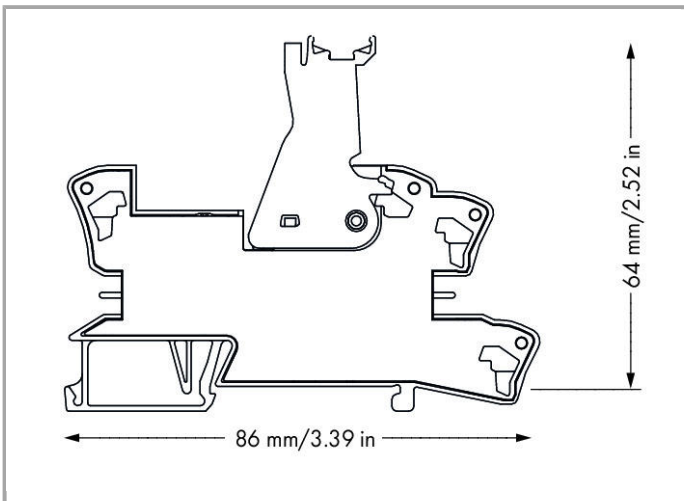

Description du produit :

Note:

**Remarque :** pour des tensions supérieures à 250 V entre modules relais connectés et pour respecter l'isolation renforcée, il faut utiliser un séparateur (par ex. 209-191).

## Données

### Données techniques

#### Circuit de commande

Nominal input voltage $U_N$	24 V AC/DC
Input voltage range (low level)	0 ... 2,5 V AC/DC
Input voltage range (high level)	15 ... 30 V AC/DC
Courant d'entrée nominal IN	10 mA

#### Circuit de charge

Type de circuit	Raccordement pour 2 conducteurs Commutation à tension nulle
Limiting continuous current	4 A
Output voltage range	12 ... 275 VAC (50/60 Hz)
Max. voltage drop at output	$\leq 1,1$ VAC
Temps d'excitation	$\leq 10$ ms
Drop-out time	$\leq 10$ ms

#### Signaling

Indication d'état	LED red
-------------------	---------

#### Sécurité & Protection

Degré de pollution	2
Tension de claquage contact-bobine (AC, 1 min.)	4 kV <sub>rms</sub>
Dielectric strength, control/load circuit (AC, 1 min)	4 kV <sub>rms</sub>
Indice de protection	IP20

#### Données de raccordement

Technique de connexion	Push-in CAGE CLAMP®
Conducteur rigide	0,34 ... 2,5 mm <sup>2</sup> / 22 ... 14 AWG
Conducteur souple	0,34 ... 2,5 mm <sup>2</sup> / 22 ... 14 AWG
Longueur de dénudage	9 ... 10 mm / 0.35 ... 0.39 inch

#### Données géométriques

Largeur	15 mm / 0.591 inch
---------	--------------------

Profondeur à partir du niveau supérieur du rail	64 mm / 2.52 inch
Profondeur	86 mm / 3.386 inch

### Données mécaniques

Type de montage	Rail 35
-----------------	---------

### Données du matériau

Couleur	gris
Poids	49.387 g

### Conditions d'environnement

Température ambiante admissible Fonctionnement pour U <sub>N</sub>	-20 ... 60 °C
Température ambiante (stockage)	-40 ... 70 °C
Température ambiante pour fonctionnement pour UL	-20 ... 40 °C
Degré de pollution	2

### Normes et spécifications

Normes/spécifications	EN 61000-6-2; EN 61000-6-3; EN 61373; EN 61010-2-201; UL 508 (max. 40 °C/2.5 A)
-----------------------	---

### Dates commerciales

Country of origin	DE
GTIN	4045454945961
Customs Tariff No.	85365005000
Product Group	6 (Interface Electronics)



### Autorisations / certificats



#### Approbations UL

Logo	Approbation	Nom du certificat
	UL UL International Netherlands B.V. (ORDINARY LOCATIONS)	E175199 Sec.6

### Produits correspondants

#### ferrule







	N° art.: 216-241 Embout d'extrémité; embout pour 0,5 mm <sup>2</sup> / AWG 22; avec isolation plastique; étamés par électrolyse; <a href="http://www.wago.com/216-241">www.wago.com/216-241</a> Cuivre électrolytique; serti de manière étanche aux gaz; selon DIN 46228, partie 4/09.90
	N° art.: 216-242 Embout d'extrémité; embout pour 0,75 mm <sup>2</sup> / AWG 20; avec isolation plastique; étamés par électrolyse; <a href="http://www.wago.com/216-242">www.wago.com/216-242</a> Cuivre électrolytique; serti de manière étanche aux gaz; selon DIN 46228, partie 4/09.90

















	<b>N° art.: 216-243</b> Embout d'extrémité; embout pour 1 mm <sup>2</sup> / AWG 18; avec isolation plastique; étamés par électrolyse; Cuivre électrolytique; serti de manière étanche aux gaz; selon DIN 46228, partie 4/09.90	<a href="http://www.wago.com/216-243">www.wago.com/216-243</a>
	<b>N° art.: 216-244</b> Embout d'extrémité; embout pour 1,5 mm <sup>2</sup> / AWG 16; avec isolation plastique; étamés par électrolyse; Cuivre électrolytique; serti de manière étanche aux gaz; selon DIN 46228, partie 4/09.90	<a href="http://www.wago.com/216-244">www.wago.com/216-244</a>
	<b>N° art.: 216-542</b> Embout d'extrémité double; Embout pour 2 x 1 mm <sup>2</sup> / AWG 2 x 18; rouge, isolé; longueur 12 mm	<a href="http://www.wago.com/216-542">www.wago.com/216-542</a>















### Jumper















	<b>N° art.: 788-118</b> Peigne de pontage; 2 pôles (1-3); isolé	<a href="http://www.wago.com/788-118">www.wago.com/788-118</a>
	<b>N° art.: 859-402</b> Peigne de pontage; 2 raccords; Courant nominal 18 A; isolé	<a href="http://www.wago.com/859-402">www.wago.com/859-402</a>
	<b>N° art.: 859-402/000-005</b> Peigne de pontage; 2 raccords; Courant nominal 18 A; isolé	<a href="http://www.wago.com/859-402/000-005">www.wago.com/859-402/000-005</a>
	<b>N° art.: 859-402/000-006</b> Peigne de pontage; 2 raccords; Courant nominal 18 A; isolé	<a href="http://www.wago.com/859-402/000-006">www.wago.com/859-402/000-006</a>
	<b>N° art.: 859-402/000-029</b> Peigne de pontage; 2 raccords; Courant nominal 18 A; isolé	<a href="http://www.wago.com/859-402/000-029">www.wago.com/859-402/000-029</a>















### Marking accessories

	<b>N° art.: 2009-110</b> Bandes de marquage; sur rouleau; non extensible; vierge; encliquetable	<a href="http://www.wago.com/2009-110">www.wago.com/2009-110</a>
	<b>N° art.: 2009-115</b> WMB-Inline; pour smartPRINTER; sur rouleau; extensible 5 - 5,2 MM; vierge; encliquetable	<a href="http://www.wago.com/2009-115">www.wago.com/2009-115</a>
	<b>N° art.: 2009-115/000-002</b> WMB-Inline; pour smartPRINTER; sur rouleau; extensible 5 - 5,2 MM; vierge; encliquetable	<a href="http://www.wago.com/2009-115/000-002">www.wago.com/2009-115/000-002</a>
	<b>N° art.: 2009-115/000-006</b> WMB-Inline; pour smartPRINTER; sur rouleau; extensible 5 - 5,2 MM; vierge; encliquetable	<a href="http://www.wago.com/2009-115/000-006">www.wago.com/2009-115/000-006</a>
	<b>N° art.: 2009-115/000-007</b> WMB-Inline; sur rouleau; extensible 5 - 5,2 MM; vierge; encliquetable	<a href="http://www.wago.com/2009-115/000-007">www.wago.com/2009-115/000-007</a>
	<b>N° art.: 2009-115/000-012</b> WMB-Inline; pour smartPRINTER; sur rouleau; extensible 5 - 5,2 MM; vierge; encliquetable	<a href="http://www.wago.com/2009-115/000-012">www.wago.com/2009-115/000-012</a>
	<b>N° art.: 2009-115/000-017</b> WMB-Inline; sur rouleau; extensible 5 - 5,2 MM; vierge; encliquetable	<a href="http://www.wago.com/2009-115/000-017">www.wago.com/2009-115/000-017</a>

	<p><b>N° art.: 2009-115/000-023</b> WMB-Inline; pour smartPRINTER; sur rouleau; extensible 5 - 5,2 MM; vierge; encliquetable</p>	<a href="http://www.wago.com/2009-115/000-023">www.wago.com/2009-115/000-023</a>
	<p><b>N° art.: 209-128</b> Adaptateur</p>	<a href="http://www.wago.com/209-128">www.wago.com/209-128</a>
	<p><b>N° art.: 209-183</b> Étiquette à enficher</p>	<a href="http://www.wago.com/209-183">www.wago.com/209-183</a>
	<p><b>N° art.: 210-110</b> Stylo feutre-graveur</p>	<a href="http://www.wago.com/210-110">www.wago.com/210-110</a>
	<p><b>N° art.: 793-501</b> Carte de repérage WMB; en carte; non extensible; vierge; encliquetable</p>	<a href="http://www.wago.com/793-501">www.wago.com/793-501</a>
	<p><b>N° art.: 793-501/000-002</b> Carte de repérage WMB; en carte; non extensible; vierge; encliquetable</p>	<a href="http://www.wago.com/793-501/000-002">www.wago.com/793-501/000-002</a>
	<p><b>N° art.: 793-501/000-005</b> Carte de repérage WMB; en carte; non extensible; vierge; encliquetable</p>	<a href="http://www.wago.com/793-501/000-005">www.wago.com/793-501/000-005</a>
	<p><b>N° art.: 793-501/000-006</b> Carte de repérage WMB; en carte; non extensible; vierge; encliquetable</p>	<a href="http://www.wago.com/793-501/000-006">www.wago.com/793-501/000-006</a>
	<p><b>N° art.: 793-501/000-007</b> Carte de repérage WMB; en carte; non extensible; vierge; encliquetable</p>	<a href="http://www.wago.com/793-501/000-007">www.wago.com/793-501/000-007</a>
	<p><b>N° art.: 793-501/000-012</b> Carte de repérage WMB; en carte; non extensible; vierge; encliquetable</p>	<a href="http://www.wago.com/793-501/000-012">www.wago.com/793-501/000-012</a>
	<p><b>N° art.: 793-501/000-017</b> Carte de repérage WMB; en carte; non extensible; vierge; encliquetable</p>	<a href="http://www.wago.com/793-501/000-017">www.wago.com/793-501/000-017</a>
	<p><b>N° art.: 793-501/000-023</b> Carte de repérage WMB; en carte; non extensible; vierge; encliquetable</p>	<a href="http://www.wago.com/793-501/000-023">www.wago.com/793-501/000-023</a>
	<p><b>N° art.: 793-501/000-024</b> Carte de repérage WMB; en carte; non extensible; vierge; encliquetable</p>	<a href="http://www.wago.com/793-501/000-024">www.wago.com/793-501/000-024</a>
	<p><b>N° art.: 793-502</b> Carte de repérage WMB; en carte; avec impression; 1 ... 10 (10x); non extensible; Impression horizontale; encliquetable</p>	<a href="http://www.wago.com/793-502">www.wago.com/793-502</a>
	<p><b>N° art.: 793-502/000-002</b> Carte de repérage WMB; en carte; avec impression; 1 ... 10 (10x); non extensible; Impression horizontale; encliquetable</p>	<a href="http://www.wago.com/793-502/000-002">www.wago.com/793-502/000-002</a>
	<p><b>N° art.: 793-502/000-005</b> Carte de repérage WMB; en carte; avec impression; 1 ... 10 (10x); non extensible; Impression horizontale; encliquetable</p>	<a href="http://www.wago.com/793-502/000-005">www.wago.com/793-502/000-005</a>

	<p><b>N° art.: 793-502/000-006</b>                      Carte de repérage WMB; en carte; avec impression; 1 ... 10 (10x); non extensible; Impression horizontale; encliquetable</p>	<a href="http://www.wago.com/793-502/000-006">www.wago.com/793-502/000-006</a>
	<p><b>N° art.: 793-502/000-007</b>                      Carte de repérage WMB; en carte; avec impression; 1 ... 10 (10x); non extensible; Impression horizontale; encliquetable</p>	<a href="http://www.wago.com/793-502/000-007">www.wago.com/793-502/000-007</a>
	<p><b>N° art.: 793-502/000-012</b>                      Carte de repérage WMB; en carte; avec impression; 1 ... 10 (10x); non extensible; Impression horizontale; encliquetable</p>	<a href="http://www.wago.com/793-502/000-012">www.wago.com/793-502/000-012</a>
	<p><b>N° art.: 793-502/000-017</b>                      Carte de repérage WMB; en carte; avec impression; 1 ... 10 (10x); non extensible; Impression horizontale; encliquetable</p>	<a href="http://www.wago.com/793-502/000-017">www.wago.com/793-502/000-017</a>
	<p><b>N° art.: 793-502/000-023</b>                      Carte de repérage WMB; en carte; avec impression; 1 ... 10 (10x); non extensible; Impression horizontale; encliquetable</p>	<a href="http://www.wago.com/793-502/000-023">www.wago.com/793-502/000-023</a>
	<p><b>N° art.: 793-502/000-024</b>                      Carte de repérage WMB; en carte; avec impression; 1 ... 10 (10x); non extensible; Impression horizontale; encliquetable</p>	<a href="http://www.wago.com/793-502/000-024">www.wago.com/793-502/000-024</a>
	<p><b>N° art.: 793-503</b>                      Carte de repérage WMB; en carte; avec impression; 11 ... 20 (10x); non extensible; Impression horizontale; encliquetable</p>	<a href="http://www.wago.com/793-503">www.wago.com/793-503</a>
	<p><b>N° art.: 793-503/000-002</b>                      Carte de repérage WMB; en carte; avec impression; 11 ... 20 (10x); non extensible; Impression horizontale; encliquetable</p>	<a href="http://www.wago.com/793-503/000-002">www.wago.com/793-503/000-002</a>
	<p><b>N° art.: 793-503/000-005</b>                      Carte de repérage WMB; en carte; avec impression; 11 ... 20 (10x); non extensible; Impression horizontale; encliquetable</p>	<a href="http://www.wago.com/793-503/000-005">www.wago.com/793-503/000-005</a>
	<p><b>N° art.: 793-503/000-006</b>                      Carte de repérage WMB; en carte; avec impression; 11 ... 20 (10x); non extensible; Impression horizontale; encliquetable</p>	<a href="http://www.wago.com/793-503/000-006">www.wago.com/793-503/000-006</a>
	<p><b>N° art.: 793-503/000-007</b>                      Carte de repérage WMB; en carte; avec impression; 11 ... 20 (10x); non extensible; Impression horizontale; encliquetable</p>	<a href="http://www.wago.com/793-503/000-007">www.wago.com/793-503/000-007</a>
	<p><b>N° art.: 793-503/000-012</b>                      Carte de repérage WMB; en carte; avec impression; 11 ... 20 (10x); non extensible; Impression horizontale; encliquetable</p>	<a href="http://www.wago.com/793-503/000-012">www.wago.com/793-503/000-012</a>
	<p><b>N° art.: 793-503/000-017</b>                      Carte de repérage WMB; en carte; avec impression; 11 ... 20 (10x); non extensible; Impression horizontale; encliquetable</p>	<a href="http://www.wago.com/793-503/000-017">www.wago.com/793-503/000-017</a>
	<p><b>N° art.: 793-503/000-023</b>                      Carte de repérage WMB; en carte; avec impression; 11 ... 20 (10x); non extensible; Impression horizontale; encliquetable</p>	<a href="http://www.wago.com/793-503/000-023">www.wago.com/793-503/000-023</a>
	<p><b>N° art.: 793-503/000-024</b>                      Carte de repérage WMB; en carte; avec impression; 11 ... 20 (10x); non extensible; Impression horizontale; encliquetable</p>	<a href="http://www.wago.com/793-503/000-024">www.wago.com/793-503/000-024</a>

	<p><b>N° art.: 793-504</b>                      Carte de repérage WMB; en carte; avec impression; 21 ... 30 (10x); non extensible; Impression horizontale; encliquetable</p>	<a href="http://www.wago.com/793-504">www.wago.com/793-504</a>
	<p><b>N° art.: 793-504/000-002</b>                      Carte de repérage WMB; en carte; avec impression; 21 ... 30 (10x); non extensible; Impression horizontale; encliquetable</p>	<a href="http://www.wago.com/793-504/000-002">www.wago.com/793-504/000-002</a>
	<p><b>N° art.: 793-504/000-005</b>                      Carte de repérage WMB; en carte; avec impression; 21 ... 30 (10x); non extensible; Impression horizontale; encliquetable</p>	<a href="http://www.wago.com/793-504/000-005">www.wago.com/793-504/000-005</a>
	<p><b>N° art.: 793-504/000-006</b>                      Carte de repérage WMB; en carte; avec impression; 21 ... 30 (10x); non extensible; Impression horizontale; encliquetable</p>	<a href="http://www.wago.com/793-504/000-006">www.wago.com/793-504/000-006</a>
	<p><b>N° art.: 793-504/000-012</b>                      Carte de repérage WMB; en carte; avec impression; 21 ... 30 (10x); non extensible; Impression horizontale; encliquetable</p>	<a href="http://www.wago.com/793-504/000-012">www.wago.com/793-504/000-012</a>
	<p><b>N° art.: 793-504/000-017</b>                      Carte de repérage WMB; en carte; avec impression; 21 ... 30 (10x); non extensible; Impression horizontale; encliquetable</p>	<a href="http://www.wago.com/793-504/000-017">www.wago.com/793-504/000-017</a>
	<p><b>N° art.: 793-504/000-023</b>                      Carte de repérage WMB; en carte; avec impression; 21 ... 30 (10x); non extensible; Impression horizontale; encliquetable</p>	<a href="http://www.wago.com/793-504/000-023">www.wago.com/793-504/000-023</a>
	<p><b>N° art.: 793-505</b>                      Carte de repérage WMB; en carte; avec impression; 31 ... 40 (10x); non extensible; Impression horizontale; encliquetable</p>	<a href="http://www.wago.com/793-505">www.wago.com/793-505</a>
	<p><b>N° art.: 793-505/000-005</b>                      Carte de repérage WMB; en carte; avec impression; 31 ... 40 (10x); non extensible; Impression horizontale; encliquetable</p>	<a href="http://www.wago.com/793-505/000-005">www.wago.com/793-505/000-005</a>
	<p><b>N° art.: 793-505/000-006</b>                      Carte de repérage WMB; en carte; avec impression; 31 ... 40 (10x); non extensible; Impression horizontale; encliquetable</p>	<a href="http://www.wago.com/793-505/000-006">www.wago.com/793-505/000-006</a>
	<p><b>N° art.: 793-505/000-007</b>                      Carte de repérage WMB; en carte; avec impression; 31 ... 40 (10x); non extensible; Impression horizontale; encliquetable</p>	<a href="http://www.wago.com/793-505/000-007">www.wago.com/793-505/000-007</a>
	<p><b>N° art.: 793-505/000-012</b>                      Carte de repérage WMB; en carte; avec impression; 31 ... 40 (10x); non extensible; Impression horizontale; encliquetable</p>	<a href="http://www.wago.com/793-505/000-012">www.wago.com/793-505/000-012</a>
	<p><b>N° art.: 793-506</b>                      Carte de repérage WMB; en carte; avec impression; 41 ... 50 (10x); non extensible; Impression horizontale; encliquetable</p>	<a href="http://www.wago.com/793-506">www.wago.com/793-506</a>
	<p><b>N° art.: 793-506/000-005</b>                      Carte de repérage WMB; en carte; avec impression; 41 ... 50 (10x); non extensible; Impression horizontale; encliquetable</p>	<a href="http://www.wago.com/793-506/000-005">www.wago.com/793-506/000-005</a>
	<p><b>N° art.: 793-506/000-006</b>                      Carte de repérage WMB; en carte; avec impression; 41 ... 50 (10x); non extensible; Impression horizontale; encliquetable</p>	<a href="http://www.wago.com/793-506/000-006">www.wago.com/793-506/000-006</a>

	<p><b>N° art.: 793-506/000-012</b>                      Carte de repérage WMB; en carte; avec impression; 41 ... 50 (10x); non extensible; Impression horizontale; encliquetable</p>	<a href="http://www.wago.com/793-506/000-012">www.wago.com/793-506/000-012</a>
	<p><b>N° art.: 793-506/000-017</b>                      Carte de repérage WMB; en carte; avec impression; 41 ... 50 (10x); non extensible; Impression horizontale; encliquetable</p>	<a href="http://www.wago.com/793-506/000-017">www.wago.com/793-506/000-017</a>
	<p><b>N° art.: 793-5501</b>                      Carte de repérage WMB; en carte; largeur des bornes 5 - 17,5 mm; extensible 5 - 5,2 MM; vierge; encliquetable</p>	<a href="http://www.wago.com/793-5501">www.wago.com/793-5501</a>
	<p><b>N° art.: 793-5501/000-002</b>                      Carte de repérage WMB; en carte; largeur des bornes 5 - 17,5 mm; extensible 5 - 5,2 MM; vierge; encliquetable</p>	<a href="http://www.wago.com/793-5501/000-002">www.wago.com/793-5501/000-002</a>
	<p><b>N° art.: 793-5501/000-005</b>                      Carte de repérage WMB; en carte; extensible 5 - 5,2 MM; vierge; encliquetable</p>	<a href="http://www.wago.com/793-5501/000-005">www.wago.com/793-5501/000-005</a>
	<p><b>N° art.: 793-5501/000-006</b>                      Carte de repérage WMB; en carte; extensible 5 - 5,2 MM; vierge; encliquetable</p>	<a href="http://www.wago.com/793-5501/000-006">www.wago.com/793-5501/000-006</a>
	<p><b>N° art.: 793-5501/000-007</b>                      Carte de repérage WMB; en carte; extensible 5 - 5,2 MM; vierge; encliquetable</p>	<a href="http://www.wago.com/793-5501/000-007">www.wago.com/793-5501/000-007</a>
	<p><b>N° art.: 793-5501/000-012</b>                      Carte de repérage WMB; en carte; extensible 5 - 5,2 MM; vierge; encliquetable</p>	<a href="http://www.wago.com/793-5501/000-012">www.wago.com/793-5501/000-012</a>
	<p><b>N° art.: 793-5501/000-014</b>                      Carte de repérage WMB; en carte; extensible 5 - 5,2 MM; vierge; encliquetable</p>	<a href="http://www.wago.com/793-5501/000-014">www.wago.com/793-5501/000-014</a>
	<p><b>N° art.: 793-5501/000-017</b>                      Carte de repérage WMB; en carte; extensible 5 - 5,2 MM; vierge; encliquetable</p>	<a href="http://www.wago.com/793-5501/000-017">www.wago.com/793-5501/000-017</a>
	<p><b>N° art.: 793-5501/000-023</b>                      Carte de repérage WMB; en carte; extensible 5 - 5,2 MM; vierge; encliquetable</p>	<a href="http://www.wago.com/793-5501/000-023">www.wago.com/793-5501/000-023</a>
	<p><b>N° art.: 793-5501/000-024</b>                      Carte de repérage WMB; en carte; extensible 5 - 5,2 MM; vierge; encliquetable</p>	<a href="http://www.wago.com/793-5501/000-024">www.wago.com/793-5501/000-024</a>
	<p><b>N° art.: 793-566</b>                      Carte de repérage WMB; en carte; avec impression; 1 ... 50 (2x); non extensible; Impression horizontale; encliquetable</p>	<a href="http://www.wago.com/793-566">www.wago.com/793-566</a>
	<p><b>N° art.: 793-566/000-002</b>                      Carte de repérage WMB; en carte; avec impression; 1 ... 50 (2x); non extensible; Impression horizontale; encliquetable</p>	<a href="http://www.wago.com/793-566/000-002">www.wago.com/793-566/000-002</a>
	<p><b>N° art.: 793-566/000-005</b>                      Carte de repérage WMB; en carte; avec impression; 1 ... 50 (2x); non extensible; Impression horizontale; encliquetable</p>	<a href="http://www.wago.com/793-566/000-005">www.wago.com/793-566/000-005</a>





N° art.: 793-566/000-006

Carte de repérage WMB; en carte; avec impression; 1 ... 50 (2x); non extensible; Impression horizontale; encliquetable

[www.wago.com/793-566/000-006](http://www.wago.com/793-566/000-006)

N° art.: 793-566/000-007

Carte de repérage WMB; en carte; avec impression; 1 ... 50 (2x); non extensible; Impression horizontale; encliquetable

[www.wago.com/793-566/000-007](http://www.wago.com/793-566/000-007)

N° art.: 793-566/000-012

Carte de repérage WMB; en carte; avec impression; 1 ... 50 (2x); non extensible; Impression horizontale; encliquetable

[www.wago.com/793-566/000-012](http://www.wago.com/793-566/000-012)

N° art.: 793-566/000-017

Carte de repérage WMB; en carte; avec impression; 1 ... 50 (2x); non extensible; Impression horizontale; encliquetable

[www.wago.com/793-566/000-017](http://www.wago.com/793-566/000-017)

N° art.: 793-566/000-023

Carte de repérage WMB; en carte; avec impression; 1 ... 50 (2x); non extensible; Impression horizontale; encliquetable

[www.wago.com/793-566/000-023](http://www.wago.com/793-566/000-023)

N° art.: 793-566/000-024

Carte de repérage WMB; en carte; avec impression; 1 ... 50 (2x); non extensible; Impression horizontale; encliquetable

[www.wago.com/793-566/000-024](http://www.wago.com/793-566/000-024)

#### General accessories



N° art.: 209-145

Porte-étiquettes de groupe

[www.wago.com/209-145](http://www.wago.com/209-145)

N° art.: 209-184

Protège-étiquettes

[www.wago.com/209-184](http://www.wago.com/209-184)

N° art.: 249-105

Porte-étiquettes de groupe

[www.wago.com/249-105](http://www.wago.com/249-105)

N° art.: 788-123

Accessoire pour module relais; Etat de fonctionnement rouge

[www.wago.com/788-123](http://www.wago.com/788-123)

N° art.: 788-148

Module de filtrage; élément de filtre RC; Tension nominale AC 230 V

[www.wago.com/788-148](http://www.wago.com/788-148)

#### tools



N° art.: 210-720

Outil de manipulation, partiellement isolé; Type 2, lame (3,5 x 0,5) mm

[www.wago.com/210-720](http://www.wago.com/210-720)

## Téléchargements

### Documentation

#### Bid Text

788-721

Jan 22, 2016

DOC

Téléchargement

Solid-State-Relais

27,6 kB

#### Additional Information



Disposal; Electrical and electronic equipment, Packaging

V 1.0.0  
Oct 15, 2018

PDF  
269,1 kB

Téléchargement

---

## smartDATA

### CAD data

3D Download 788-721

URL

Téléchargement

---

Sous réserve de modifications.