

Fiche technique | Numéro d'article: 2004-1205

Borne de passage pour 2 conducteurs; 4 mm²; pour applications Ex e II;
Marquage latéral et central; Pour rail 35 x 15 et 35 x 7,5; Push-in CAGE
CLAMP®

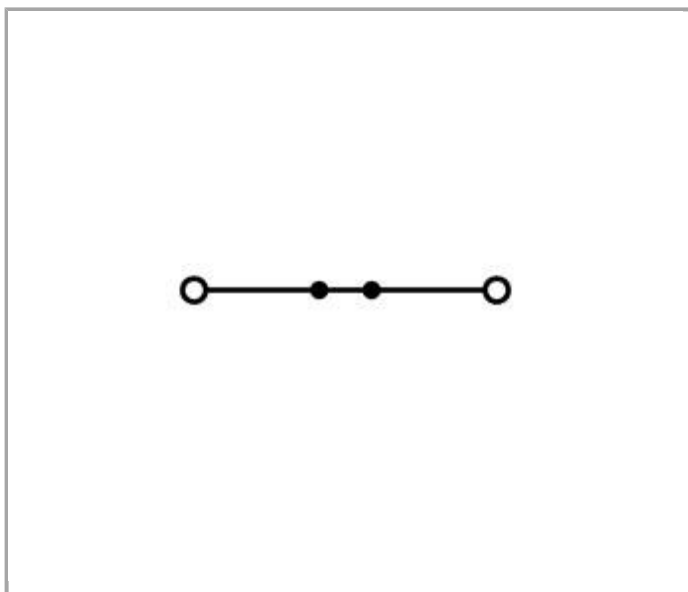

www.wago.com/2004-1205

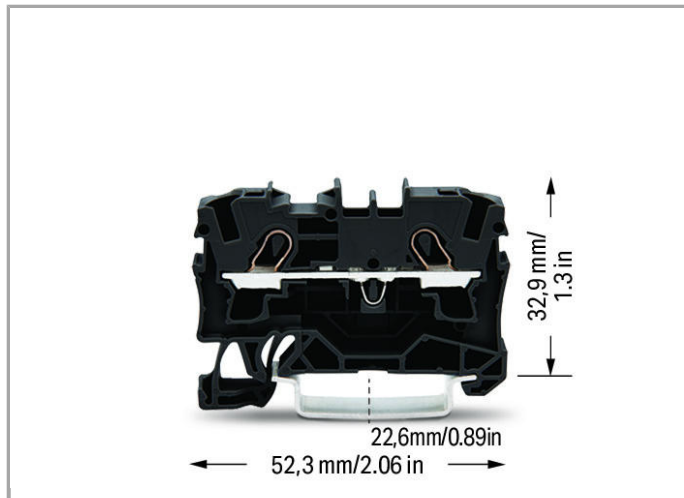
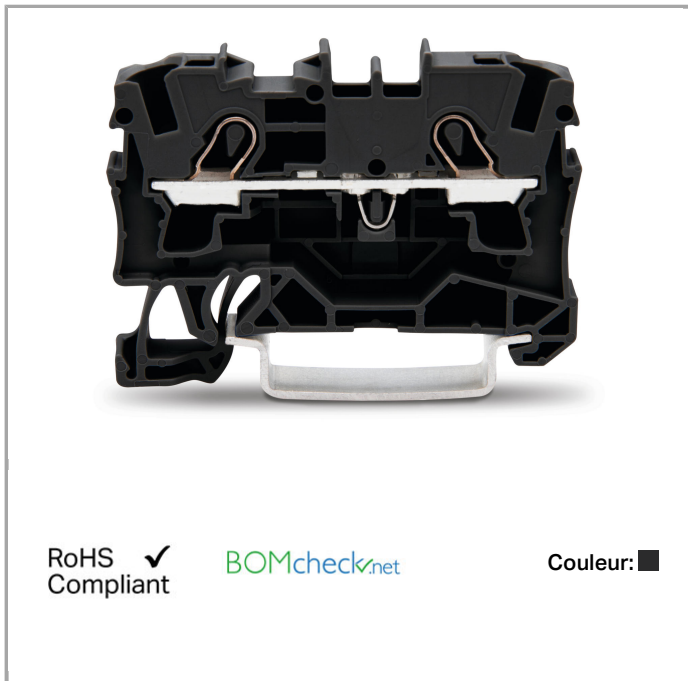

Données

Données électriques

Tension de référence EN (Ex e II)	550 V
Courant de référence (Ex e II)	30 A

Ratings per IEC/EN 60664-1

Tension de référence (III / 3)	800 V
Tension assignée de tenue aux chocs (III / 3)	8 kV
Courant	32 A
Courant de référence 2	41 A
Légende Données de référence	(III / 3) ≙ Catégorie de surtension III / degré de pollution 3

Approvals per UL 1059

Tension de référence UL (Use Group B)	600 V
Courant de référence UL (Use Group B)	30 A
Tension de référence UL (Use Group C)	600 V
Courant de référence UL (Use Group C)	30 A

Approvals per CSA

Tension de référence CSA (Use Group B)	600 V
Courant de référence CSA (Use Group B)	30 A
Tension de référence CSA (Use Group C)	600 V
Courant de référence CSA (Use Group C)	30 A

Données de raccordement

Technique de connexion	Push-in CAGE CLAMP®
Type d'actionnement	Push-in Outil de manipulation
Matière plastique conducteur raccordable	Cuivre
Section nominale :	4 mm ²
Conducteur rigide	0,5 ... 6 mm ² / 20 ... 10 AWG
Conducteur rigide, enfichage direct	1,5 ... 6 mm ² / 14 ... 10 AWG
Conducteur souple	0,5 ... 6 mm ² / 20 ... 10 AWG
conducteur souple avec embout d'extrémité, directement enfichable à partir de	1,5 mm ² / 18 AWG
Longueur de dénudage	11 ... 13 mm / 0.43 ... 0.51 inch
Nombre total des points de serrage	2
Nombre total des potentiels	1
nombre des niveaux	1
Type de câblage	câblage frontal

Données géométriques

Largeur	6,2 mm / 0.244 inch
Profondeur à partir du niveau supérieur du rail	32,9 mm / 1.295 inch
Profondeur	52,3 mm / 2.059 inch

Données mécaniques

Mode de construction	type horizontal
Type de montage	Rail 35
Niveau de marquage	Marquage central/latéral

Données du matériau



Couleur	noir
Matière isolante	Polyamide 66 (PA 66)
Charge calorifique	0.114 MJ
Poids	6.325 g

Dates commerciales



Country of origin	DE
GTIN	4045454537449
Customs Tariff No.	85369010000
Product Group	22 (TOPJOB S)

Autorisations / certificats



Ex-approbations

Logo	Approbation	Nom du certificat
	AEx Underwriters Laboratories Inc.	E185892
	ATEX Physikalisch Technische Bundesanstalt (PTB)	PTB 05 ATEX 1095 U (II 2 G/D Ex eII bzw. I M2 Ex eI)

Approbations spécifiques au pays

Logo	Approbation	Nom du certificat
	CCA DEKRA Certification B.V.	2160584.10
	CCA DEKRA Certification B.V.	NTR NL-7088
	CSA DEKRA Certification B.V.	1645435

Approbations de navire





Logo	Approbation	Nom du certificat
	ABS American Bureau of Shipping	14-HG1293677-PDA
	BV Bureau Veritas S.A.	38586/A0 BV
	LR Lloyds Register	91/20112 (E9)

Approbations UL

Logo	Approbation	Nom du certificat
	UL UL International Germany GmbH	E45172

Produits correspondants















End plate

















	N° art.: 2004-1291 Plaque d'extrémité et intermédiaire; épaisseur 1 mm	www.wago.com/2004-1291
	N° art.: 2004-1292 Plaque d'extrémité et intermédiaire; épaisseur 1 mm	www.wago.com/2004-1292
	N° art.: 2004-1293 Séparateur; épaisseur 2 mm; en saillie	www.wago.com/2004-1293
	N° art.: 2004-1294 Séparateur; épaisseur 2 mm; en saillie	www.wago.com/2004-1294
	N° art.: 209-190 Séparateur Ex e/Ex i; épaisseur 3 mm; Largeur 90 mm	www.wago.com/209-190
	N° art.: 209-191 Séparateur Ex e/Ex i; épaisseur 3 mm; Largeur 120 mm	www.wago.com/209-191















Insulation stop

	N° art.: 2004-171 Réducteur isolant de sécurité; 0,25 - 0,5 mm ² ; 5 pièces/bande	www.wago.com/2004-171
	N° art.: 2004-172 Réducteur isolant de sécurité; 0,75 - 1 mm ² ; 5 pièces/bande	www.wago.com/2004-172

Marking accessories

	N° art.: 2009-110 Bandes de marquage; sur rouleau; non extensible; vierge; encliquetable	www.wago.com/2009-110
	N° art.: 2009-115 WMB-Inline; pour smartPRINTER; sur rouleau; extensible 5 - 5,2 MM; vierge; encliquetable	www.wago.com/2009-115
	N° art.: 2009-115/000-002 WMB-Inline; pour smartPRINTER; sur rouleau; extensible 5 - 5,2 MM; vierge; encliquetable	www.wago.com/2009-115/000-002
	N° art.: 2009-115/000-006 WMB-Inline; pour smartPRINTER; sur rouleau; extensible 5 - 5,2 MM; vierge; encliquetable	www.wago.com/2009-115/000-006
	N° art.: 2009-115/000-007 WMB-Inline; sur rouleau; extensible 5 - 5,2 MM; vierge; encliquetable	www.wago.com/2009-115/000-007
	N° art.: 2009-115/000-012 WMB-Inline; pour smartPRINTER; sur rouleau; extensible 5 - 5,2 MM; vierge; encliquetable	www.wago.com/2009-115/000-012
	N° art.: 2009-115/000-017 WMB-Inline; sur rouleau; extensible 5 - 5,2 MM; vierge; encliquetable	www.wago.com/2009-115/000-017
	N° art.: 2009-115/000-023 WMB-Inline; pour smartPRINTER; sur rouleau; extensible 5 - 5,2 MM; vierge; encliquetable	www.wago.com/2009-115/000-023
	N° art.: 2009-115/000-024 WMB-Inline; pour smartPRINTER; sur rouleau; extensible 5 - 5,2 MM; vierge; encliquetable	www.wago.com/2009-115/000-024
	N° art.: 2009-135 WMB-Inline; pour smartPRINTER; sur rouleau; extensible 5 - 5,2 MM; vierge; encliquetable	www.wago.com/2009-135
	N° art.: 2009-145 Mini-WSB Inline; pour smartPRINTER; sur rouleau; extensible 5 - 5,2 MM; vierge; encliquetable	www.wago.com/2009-145
	N° art.: 2009-145/000-002 Mini-WSB Inline; sur rouleau; extensible 5 - 5,2 MM; vierge; encliquetable	www.wago.com/2009-145/000-002
	N° art.: 2009-145/000-005 Mini-WSB Inline; vierge; 1700 étiquettes Mini-WSB (5 mm) sur rouleau; extensible 5 - 5,2 MM	www.wago.com/2009-145/000-005
	N° art.: 2009-145/000-006 Mini-WSB Inline; pour smartPRINTER; sur rouleau; extensible 5 - 5,2 MM; vierge; encliquetable	www.wago.com/2009-145/000-006
	N° art.: 2009-145/000-007 Mini-WSB Inline; vierge; 1700 étiquettes Mini-WSB (5 mm) sur rouleau; extensible 5 - 5,2 MM	www.wago.com/2009-145/000-007

	<p>N° art.: 2009-145/000-012 Mini-WSB Inline; pour smartPRINTER; sur rouleau; extensible 5 - 5,2 MM; vierge; encliquetable</p>	www.wago.com/2009-145/000-012
	<p>N° art.: 2009-145/000-023 Mini-WSB Inline; sur rouleau; extensible 5 - 5,2 MM; vierge; encliquetable</p>	www.wago.com/2009-145/000-023
	<p>N° art.: 2009-145/000-024 Mini-WSB Inline; sur rouleau; extensible 5 - 5,2 MM; vierge; encliquetable</p>	www.wago.com/2009-145/000-024
	<p>N° art.: 2009-191 Porte-étiquettes de groupe</p>	www.wago.com/2009-191
	<p>N° art.: 2009-192 Porte-étiquettes de groupe</p>	www.wago.com/2009-192
	<p>N° art.: 2009-193 Porte-étiquettes de groupe</p>	www.wago.com/2009-193
	<p>N° art.: 2009-198 Adaptateur</p>	www.wago.com/2009-198
	<p>N° art.: 248-501 Système de repérage rapide Mini-WSB; vierge; Largeur d'étiquettes 5 mm; 10 bandes à 10 étiquettes par carte</p>	www.wago.com/248-501
	<p>N° art.: 248-501/000-002 Carte de repérage mini WSB; en carte; non extensible; vierge; encliquetable</p>	www.wago.com/248-501/000-002
	<p>N° art.: 248-501/000-005 Carte de repérage mini WSB; en carte; vierge; encliquetable</p>	www.wago.com/248-501/000-005
	<p>N° art.: 248-501/000-006 Carte de repérage mini WSB; en carte; non extensible; vierge; encliquetable</p>	www.wago.com/248-501/000-006
	<p>N° art.: 248-501/000-007 Carte de repérage mini WSB; en carte; non extensible; vierge; encliquetable</p>	www.wago.com/248-501/000-007
	<p>N° art.: 248-501/000-012 Carte de repérage mini WSB; en carte; non extensible; vierge; encliquetable</p>	www.wago.com/248-501/000-012
	<p>N° art.: 248-501/000-017 Carte de repérage mini WSB; en carte; non extensible; vierge; encliquetable</p>	www.wago.com/248-501/000-017
	<p>N° art.: 248-501/000-023 Carte de repérage mini WSB; en carte; non extensible; vierge; encliquetable</p>	www.wago.com/248-501/000-023
	<p>N° art.: 248-501/000-024 Carte de repérage mini WSB; en carte; non extensible; vierge; encliquetable</p>	www.wago.com/248-501/000-024

	N° art.: 793-501 Carte de repérage WMB; en carte; non extensible; vierge; encliquetable	www.wago.com/793-501
	N° art.: 793-501/000-002 Carte de repérage WMB; en carte; non extensible; vierge; encliquetable	www.wago.com/793-501/000-002
	N° art.: 793-501/000-005 Carte de repérage WMB; en carte; non extensible; vierge; encliquetable	www.wago.com/793-501/000-005
	N° art.: 793-501/000-006 Carte de repérage WMB; en carte; non extensible; vierge; encliquetable	www.wago.com/793-501/000-006
	N° art.: 793-501/000-007 Carte de repérage WMB; en carte; non extensible; vierge; encliquetable	www.wago.com/793-501/000-007
	N° art.: 793-501/000-012 Carte de repérage WMB; en carte; non extensible; vierge; encliquetable	www.wago.com/793-501/000-012
	N° art.: 793-501/000-017 Carte de repérage WMB; en carte; non extensible; vierge; encliquetable	www.wago.com/793-501/000-017
	N° art.: 793-501/000-023 Carte de repérage WMB; en carte; non extensible; vierge; encliquetable	www.wago.com/793-501/000-023
	N° art.: 793-501/000-024 Carte de repérage WMB; en carte; non extensible; vierge; encliquetable	www.wago.com/793-501/000-024
	N° art.: 793-5501 Carte de repérage WMB; en carte; largeur des bornes 5 - 17,5 mm; extensible 5 - 5,2 MM; vierge; encliquetable	www.wago.com/793-5501
	N° art.: 793-5501/000-002 Carte de repérage WMB; en carte; largeur des bornes 5 - 17,5 mm; extensible 5 - 5,2 MM; vierge; encliquetable	www.wago.com/793-5501/000-002
	N° art.: 793-5501/000-005 Carte de repérage WMB; en carte; extensible 5 - 5,2 MM; vierge; encliquetable	www.wago.com/793-5501/000-005
	N° art.: 793-5501/000-006 Carte de repérage WMB; en carte; extensible 5 - 5,2 MM; vierge; encliquetable	www.wago.com/793-5501/000-006
	N° art.: 793-5501/000-007 Carte de repérage WMB; en carte; extensible 5 - 5,2 MM; vierge; encliquetable	www.wago.com/793-5501/000-007
	N° art.: 793-5501/000-012 Carte de repérage WMB; en carte; extensible 5 - 5,2 MM; vierge; encliquetable	www.wago.com/793-5501/000-012

**N° art.: 793-5501/000-017**

Carte de repérage WMB; en carte; extensible 5 - 5,2 MM; vierge; encliquetable

www.wago.com/793-5501/000-017**N° art.: 793-5501/000-023**

Carte de repérage WMB; en carte; extensible 5 - 5,2 MM; vierge; encliquetable

www.wago.com/793-5501/000-023**N° art.: 793-5501/000-024**

Carte de repérage WMB; en carte; extensible 5 - 5,2 MM; vierge; encliquetable

www.wago.com/793-5501/000-024**ferrule****N° art.: 216-262**Embout d'extrémité; embout pour 0,75 mm² / AWG 20; avec isolation plastique; étamés par électrolyse; Cuivre électrolytique; serti de manière étanche aux gaz; selon DIN 46228, partie 4/09.90www.wago.com/216-262**N° art.: 216-263**Embout d'extrémité; embout pour 1 mm² / AWG 18; avec isolation plastique; étamés par électrolyse; Cuivre électrolytique; serti de manière étanche aux gaz; selon DIN 46228, partie 4/09.90www.wago.com/216-263**N° art.: 216-264**Embout d'extrémité; embout pour 1,5 mm² / AWG 16; avec isolation plastique; étamés par électrolyse; Cuivre électrolytique; serti de manière étanche aux gaz; selon DIN 46228, partie 4/09.90www.wago.com/216-264**N° art.: 216-266**Embout d'extrémité; embout pour 2,5 mm² / AWG 14; avec isolation plastique; étamés par électrolyse; Cuivre électrolytique; serti de manière étanche aux gaz; selon DIN 46228, partie 4/09.90www.wago.com/216-266**N° art.: 216-267**Embout d'extrémité; embout pour 4 mm² / AWG 12; avec isolation plastique; étamés par électrolyse; Cuivre électrolytique; serti de manière étanche aux gaz; selon DIN 46228, partie 4/09.90www.wago.com/216-267**Carrier rail****N° art.: 210-112**

Rail acier; 35 x 7,5; épaisseur 1 mm; longueur 2 m; perforé; d'après EN 60715; Largeur de trou 25 mm; pas des trous 36 mm

www.wago.com/210-112**N° art.: 210-113**

Rail acier; 35 x 7,5; épaisseur 1 mm; longueur 2 m; non perforé; d'après EN 60715

www.wago.com/210-113**N° art.: 210-114**

Rail acier; 35 x 15; épaisseur 1,5 mm; longueur 2 m; non perforé; d'après EN 60715

www.wago.com/210-114**N° art.: 210-115**

Rail acier; 35 x 7,5; épaisseur 1 mm; longueur 2 m; perforé; d'après EN 60715; Largeur de trou 18 mm; pas des trous 25 mm

www.wago.com/210-115**N° art.: 210-118**

Rail acier; 35 x 15; épaisseur 2,3 mm; longueur 2 m; non perforé; d'après EN 60715

www.wago.com/210-118**N° art.: 210-196**

Rail aluminium; 35 x 8,2; épaisseur 1,6 mm; longueur 2 m; non perforé; d'après EN 60715

www.wago.com/210-196**N° art.: 210-197**

Rail acier; 35 x 15; épaisseur 1,5 mm; longueur 2 m; perforé; d'après EN 60715

www.wago.com/210-197**N° art.: 210-198**

Rail en cuivre; 35 x 15; épaisseur 2,3 mm; longueur 2 m; non perforé; d'après EN 60715

www.wago.com/210-198

Protective Warning Marker



N° art.: 2004-115

Obtuteur de protection avec signalisation de danger; avec signalisation de danger; pour 5 bornes

www.wago.com/2004-115

check



N° art.: 2004-511

Connecteur modulaire TOPJOB® S; modulaires; pour fentes de pontage; 1 pôle

www.wago.com/2004-511

N° art.: 2004-549

Module vide; modulaires; pour sauter p.ex. des bornes pontées

www.wago.com/2004-549

N° art.: 2004-552

Connecteur femelle TOPJOB® S; pour fentes de pontage; 2 pôles

www.wago.com/2004-552

N° art.: 2004-553

Connecteur femelle TOPJOB® S; pour fentes de pontage; 3 pôles

www.wago.com/2004-553

N° art.: 2004-554

Connecteur femelle TOPJOB® S; pour fentes de pontage; 4 pôles

www.wago.com/2004-554

N° art.: 2004-555

Connecteur femelle TOPJOB® S; pour fentes de pontage; 5 pôles

www.wago.com/2004-555

N° art.: 2009-174

Adaptateur de test; pour fiche de test Ø 4 mm; pour tester les bornes sur rail TOPJOB®S

www.wago.com/2009-174

N° art.: 2009-182

Prise de test; pour max. 2,5 mm²; pour le raccordement sans outil des conducteurs de contrôle individuels de 0,08www.wago.com/2009-182

tools



N° art.: 210-658

Outil de manipulation, partiellement isolé; Lame (3,5 x 0,5) mm; court; Coudé

www.wago.com/210-658

N° art.: 210-720

Outil de manipulation, partiellement isolé; Type 2, lame (3,5 x 0,5) mm

www.wago.com/210-720

Jumper



N° art.: 2004-402

Peigne de pontage; isolé; 2 raccords; Courant nominal 32 A

www.wago.com/2004-402

N° art.: 2004-403

Peigne de pontage; isolé; 3 raccords; Courant nominal 32 A

www.wago.com/2004-403

N° art.: 2004-404

Peigne de pontage; isolé; 4 raccords; Courant nominal 32 A

www.wago.com/2004-404

N° art.: 2004-405

Peigne de pontage; isolé; 5 raccords; Courant nominal 32 A

www.wago.com/2004-405

N° art.: 2004-405/011-000

Contact de pontage en étoile; isolé; 3 pôles (1-3-5); IN = IN borne

www.wago.com/2004-405/011-000



N° art.: 2004-406
Peigne de pontage; isolé; 6 raccords; Courant nominal 32 A

www.wago.com/2004-406



N° art.: 2004-406/020-000
Contact de pontage sous forme de triangle; isolé; 1-2 3-4 5-6; IN = IN borne

www.wago.com/2004-406/020-000



N° art.: 2004-407
Peigne de pontage; isolé; 7 raccords; Courant nominal 32 A

www.wago.com/2004-407



N° art.: 2004-408
Peigne de pontage; isolé; 8 raccords; Courant nominal 32 A

www.wago.com/2004-408



N° art.: 2004-409
Peigne de pontage; isolé; 9 raccords; Courant nominal 32 A

www.wago.com/2004-409



N° art.: 2004-410
Peigne de pontage; isolé; 10 raccords; Courant nominal 32 A

www.wago.com/2004-410



N° art.: 2004-433
Peigne de pontage; isolé; de 1 à 3; Courant nominal 32 A

www.wago.com/2004-433



N° art.: 2004-434
Peigne de pontage; isolé; de 1 à 4; Courant nominal 32 A

www.wago.com/2004-434



N° art.: 2004-435
Peigne de pontage; isolé; de 1 à 5; Courant nominal 32 A

www.wago.com/2004-435



N° art.: 2004-436
Peigne de pontage; isolé; de 1 à 6; Courant nominal 32 A

www.wago.com/2004-436



N° art.: 2004-437
Peigne de pontage; isolé; de 1 à 7; Courant nominal 32 A

www.wago.com/2004-437



N° art.: 2004-438
Peigne de pontage; isolé; de 1 à 8; Courant nominal 32 A

www.wago.com/2004-438



N° art.: 2004-439
Peigne de pontage; isolé; de 1 à 9; Courant nominal 32 A

www.wago.com/2004-439



N° art.: 2004-440
Peigne de pontage; isolé; de 1 à 10; Courant nominal 32 A

www.wago.com/2004-440



N° art.: 2006-499
Contact de pontage réducteur; isolé; de 6/4 mm² à 4/2,5/1,5 mm²; Courant nominal 32 A

www.wago.com/2006-499



N° art.: 2016-499
Contact de pontage réducteur; isolé; de 16/10 mm² à 10/6/4/2,5 mm²; Courant nominal 57 A

www.wago.com/2016-499



N° art.: 210-103
Chaîne de pontage en fil; isolé; 50 raccords

www.wago.com/210-103

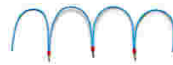

N° art.: 210-123
Chaîne de pontage en fil; isolé; 50 raccords

www.wago.com/210-123



Téléchargements

Documentation

Bid Text

2004-1205	Aug 13, 2018	DOCX	Téléchargement
Reihenklennen, TOPJOB S		15,0 kB	

smartDATA

CAD data

3D Download 2004-1205		URL	Téléchargement
-----------------------	--	-----	----------------

Sous réserve de modifications.