

# Fiche technique | Numéro d'article: 2004-1206

Borne de passage pour 2 conducteurs; 4 mm<sup>2</sup>; pour applications Ex e II;  
Marquage latéral et central; Pour rail 35 x 15 et 35 x 7,5; Push-in CAGE  
CLAMP®

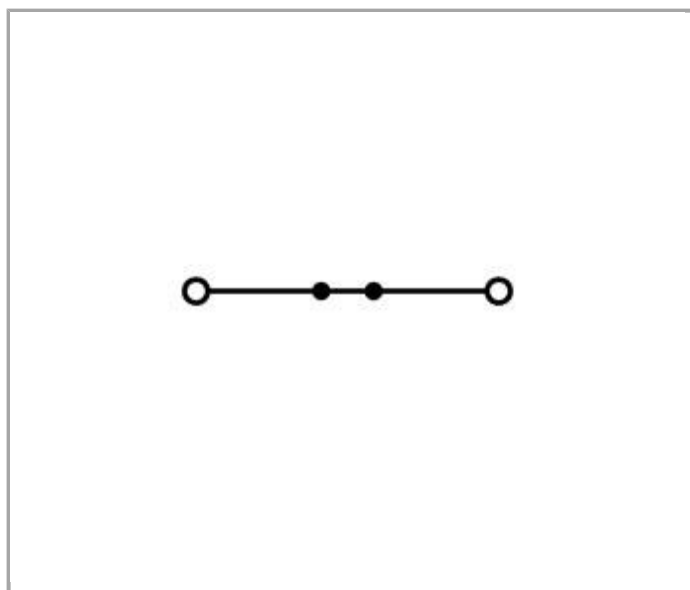

[www.wago.com/2004-1206](http://www.wago.com/2004-1206)

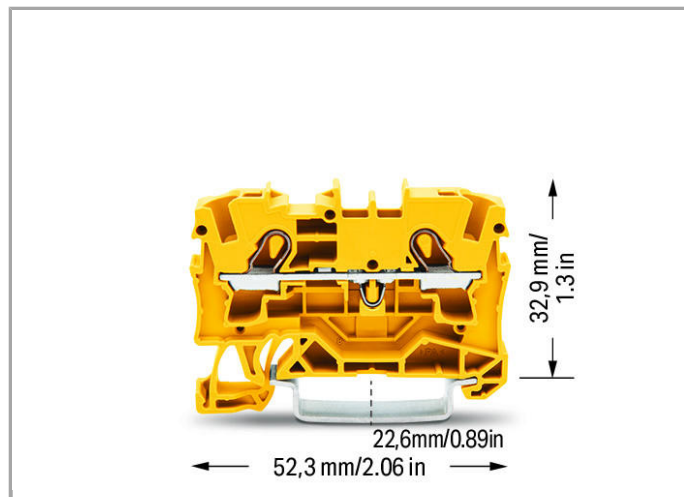
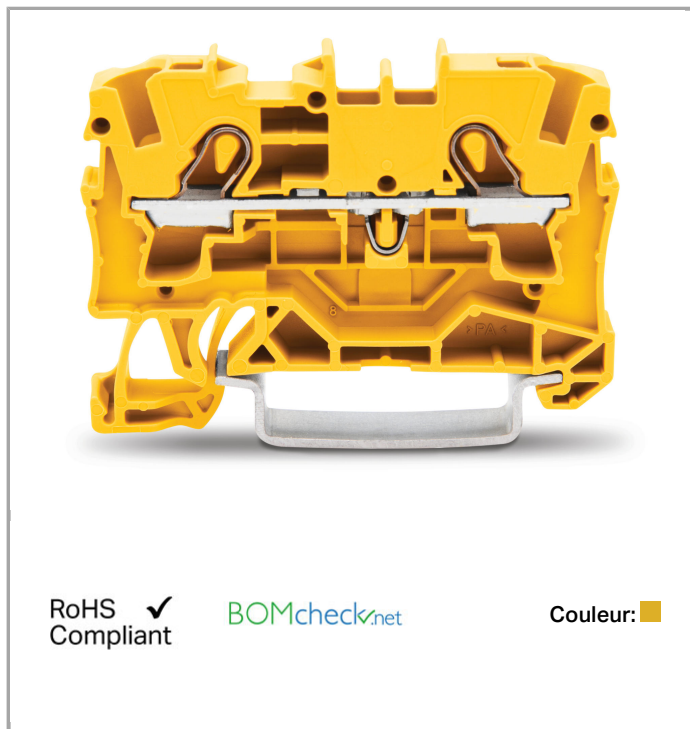

## Données

### Données électriques

Tension de référence EN (Ex e II)	550 V
Courant de référence (Ex e II)	30 A

### Ratings per IEC/EN 60664-1

Tension de référence (III / 3)	800 V
Tension assignée de tenue aux chocs (III / 3)	8 kV
Courant	32 A
Courant de référence 2	41 A
Légende Données de référence	(III / 3) ≙ Catégorie de surtension III / degré de pollution 3

### Approvals per UL 1059

Tension de référence UL (Use Group B)	600 V
Courant de référence UL (Use Group B)	30 A
Tension de référence UL (Use Group C)	600 V
Courant de référence UL (Use Group C)	30 A

### Approvals per CSA

Tension de référence CSA (Use Group B)	600 V
Courant de référence CSA (Use Group B)	30 A
Tension de référence CSA (Use Group C)	600 V
Courant de référence CSA (Use Group C)	30 A

### Données de raccordement

Technique de connexion	Push-in CAGE CLAMP®
Type d'actionnement	Push-in Outil de manipulation
Matière plastique conducteur raccordable	Cuivre
Section nominale :	4 mm <sup>2</sup>
Conducteur rigide	0,5 ... 6 mm <sup>2</sup> / 20 ... 10 AWG
Conducteur rigide, enfichage direct	1,5 ... 6 mm <sup>2</sup> / 14 ... 10 AWG
Conducteur souple	0,5 ... 6 mm <sup>2</sup> / 20 ... 10 AWG
conducteur souple avec embout d'extrémité, directement enfichable à partir de	1,5 mm <sup>2</sup> / 18 AWG
Longueur de dénudage	11 ... 13 mm / 0.43 ... 0.51 inch
Nombre total des points de serrage	2
Nombre total des potentiels	1
nombre des niveaux	1
Type de câblage	câblage frontal

### Données géométriques

Largeur	6,2 mm / 0.244 inch
Profondeur à partir du niveau supérieur du rail	32,9 mm / 1.295 inch

Profondeur	52,3 mm / 2.059 inch
------------	----------------------

### Données mécaniques

Mode de construction	type horizontal
Type de montage	Rail 35
Niveau de marquage	Marquage central/latéral

### Données du matériau

Couleur	jaune
Matière isolante	Polyamide 66 (PA 66)
Charge calorifique	0.114 MJ
Poids	6.325 g

### Dates commerciales

Country of origin	DE
GTIN	4045454537456
Customs Tariff No.	85369010000
Product Group	22 (TOPJOB S)

### Autorisations / certificats

#### Ex-approbations

Logo	Approbation	Nom du certificat
------	-------------	-------------------



AEx Underwriters Laboratories Inc.	E185892
---------------------------------------	---------



ATEX Physikalisch Technische Bundesanstalt (PTB)	PTB 05 ATEX 1095 U (II 2 G/D Ex eII bzw. I M2 Ex eI)
---	--

#### Approbations spécifiques au pays

Logo	Approbation	Nom du certificat
------	-------------	-------------------



CCA DEKRA Certification B.V.	2160584.10
---------------------------------	------------



CCA DEKRA Certification B.V.	NTR NL-7088
---------------------------------	-------------

CSA DEKRA Certification B.V.	1645435
---------------------------------	---------



## Approbations de navire







Logo	Approbation	Nom du certificat
	<b>ABS</b> American Bureau of Shipping	14-HG1293677-PDA
	<b>BV</b> Bureau Veritas S.A.	38586/A0 BV
	<b>LR</b> Lloyds Register	91/20112 (E9)















## Approbations UL

Logo	Approbation	Nom du certificat
	<b>UL</b> UL International Germany GmbH	E45172



## Produits correspondants

## Jumper

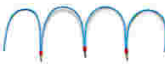
	<b>N° art.: 2004-402</b> Peigne de pontage; isolé; 2 raccords; Courant nominal 32 A	<a href="http://www.wago.com/2004-402">www.wago.com/2004-402</a>
	<b>N° art.: 2004-403</b> Peigne de pontage; isolé; 3 raccords; Courant nominal 32 A	<a href="http://www.wago.com/2004-403">www.wago.com/2004-403</a>
	<b>N° art.: 2004-404</b> Peigne de pontage; isolé; 4 raccords; Courant nominal 32 A	<a href="http://www.wago.com/2004-404">www.wago.com/2004-404</a>
	<b>N° art.: 2004-405</b> Peigne de pontage; isolé; 5 raccords; Courant nominal 32 A	<a href="http://www.wago.com/2004-405">www.wago.com/2004-405</a>
	<b>N° art.: 2004-405/011-000</b> Contact de pontage en étoile; isolé; 3 pôles (1-3-5); IN = IN borne	<a href="http://www.wago.com/2004-405/011-000">www.wago.com/2004-405/011-000</a>
	<b>N° art.: 2004-406</b> Peigne de pontage; isolé; 6 raccords; Courant nominal 32 A	<a href="http://www.wago.com/2004-406">www.wago.com/2004-406</a>
	<b>N° art.: 2004-406/020-000</b> Contact de pontage sous forme de triangle; isolé; 1-2 3-4 5-6; IN = IN borne	<a href="http://www.wago.com/2004-406/020-000">www.wago.com/2004-406/020-000</a>

















	<b>N° art.: 2004-407</b> Peigne de pontage; isolé; 7 raccords; Courant nominal 32 A	<a href="http://www.wago.com/2004-407">www.wago.com/2004-407</a>
	<b>N° art.: 2004-408</b> Peigne de pontage; isolé; 8 raccords; Courant nominal 32 A	<a href="http://www.wago.com/2004-408">www.wago.com/2004-408</a>
	<b>N° art.: 2004-409</b> Peigne de pontage; isolé; 9 raccords; Courant nominal 32 A	<a href="http://www.wago.com/2004-409">www.wago.com/2004-409</a>
	<b>N° art.: 2004-410</b> Peigne de pontage; isolé; 10 raccords; Courant nominal 32 A	<a href="http://www.wago.com/2004-410">www.wago.com/2004-410</a>
	<b>N° art.: 2004-433</b> Peigne de pontage; isolé; de 1 à 3; Courant nominal 32 A	<a href="http://www.wago.com/2004-433">www.wago.com/2004-433</a>
	<b>N° art.: 2004-434</b> Peigne de pontage; isolé; de 1 à 4; Courant nominal 32 A	<a href="http://www.wago.com/2004-434">www.wago.com/2004-434</a>
	<b>N° art.: 2004-435</b> Peigne de pontage; isolé; de 1 à 5; Courant nominal 32 A	<a href="http://www.wago.com/2004-435">www.wago.com/2004-435</a>
	<b>N° art.: 2004-436</b> Peigne de pontage; isolé; de 1 à 6; Courant nominal 32 A	<a href="http://www.wago.com/2004-436">www.wago.com/2004-436</a>
	<b>N° art.: 2004-437</b> Peigne de pontage; isolé; de 1 à 7; Courant nominal 32 A	<a href="http://www.wago.com/2004-437">www.wago.com/2004-437</a>
	<b>N° art.: 2004-438</b> Peigne de pontage; isolé; de 1 à 8; Courant nominal 32 A	<a href="http://www.wago.com/2004-438">www.wago.com/2004-438</a>
	<b>N° art.: 2004-439</b> Peigne de pontage; isolé; de 1 à 9; Courant nominal 32 A	<a href="http://www.wago.com/2004-439">www.wago.com/2004-439</a>
	<b>N° art.: 2004-440</b> Peigne de pontage; isolé; de 1 à 10; Courant nominal 32 A	<a href="http://www.wago.com/2004-440">www.wago.com/2004-440</a>
	<b>N° art.: 2006-499</b> Contact de pontage réducteur; isolé; de 6/4 mm <sup>2</sup> a 4/2,5/1,5 mm <sup>2</sup> ; Courant nominal 32 A	<a href="http://www.wago.com/2006-499">www.wago.com/2006-499</a>
	<b>N° art.: 2016-499</b> Contact de pontage réducteur; isolé; de 16/10 mm <sup>2</sup> à 10/6/4/2,5 mm <sup>2</sup> ; Courant nominal 57 A	<a href="http://www.wago.com/2016-499">www.wago.com/2016-499</a>
	<b>N° art.: 210-103</b> Chaîne de pontage en fil; isolé; 50 raccords	<a href="http://www.wago.com/210-103">www.wago.com/210-103</a>
	<b>N° art.: 210-123</b> Chaîne de pontage en fil; isolé; 50 raccords	<a href="http://www.wago.com/210-123">www.wago.com/210-123</a>

tools

	<b>N° art.: 210-658</b> Outil de manipulation, partiellement isolé; Lame (3,5 x 0,5) mm; court; Coudé	<a href="http://www.wago.com/210-658">www.wago.com/210-658</a>
	<b>N° art.: 210-720</b> Outil de manipulation, partiellement isolé; Type 2, lame (3,5 x 0,5) mm	<a href="http://www.wago.com/210-720">www.wago.com/210-720</a>

Marking accessories

	<b>N° art.: 2009-110</b> Bandes de marquage; sur rouleau; non extensible; vierge; encliquetable	<a href="http://www.wago.com/2009-110">www.wago.com/2009-110</a>
	<b>N° art.: 2009-115</b> WMB-Inline; pour smartPRINTER; sur rouleau; extensible 5 - 5,2 MM; vierge; encliquetable	<a href="http://www.wago.com/2009-115">www.wago.com/2009-115</a>
	<b>N° art.: 2009-115/000-002</b> WMB-Inline; pour smartPRINTER; sur rouleau; extensible 5 - 5,2 MM; vierge; encliquetable	<a href="http://www.wago.com/2009-115/000-002">www.wago.com/2009-115/000-002</a>
	<b>N° art.: 2009-115/000-006</b> WMB-Inline; pour smartPRINTER; sur rouleau; extensible 5 - 5,2 MM; vierge; encliquetable	<a href="http://www.wago.com/2009-115/000-006">www.wago.com/2009-115/000-006</a>
	<b>N° art.: 2009-115/000-007</b> WMB-Inline; sur rouleau; extensible 5 - 5,2 MM; vierge; encliquetable	<a href="http://www.wago.com/2009-115/000-007">www.wago.com/2009-115/000-007</a>
	<b>N° art.: 2009-115/000-012</b> WMB-Inline; pour smartPRINTER; sur rouleau; extensible 5 - 5,2 MM; vierge; encliquetable	<a href="http://www.wago.com/2009-115/000-012">www.wago.com/2009-115/000-012</a>
	<b>N° art.: 2009-115/000-017</b> WMB-Inline; sur rouleau; extensible 5 - 5,2 MM; vierge; encliquetable	<a href="http://www.wago.com/2009-115/000-017">www.wago.com/2009-115/000-017</a>
	<b>N° art.: 2009-115/000-023</b> WMB-Inline; pour smartPRINTER; sur rouleau; extensible 5 - 5,2 MM; vierge; encliquetable	<a href="http://www.wago.com/2009-115/000-023">www.wago.com/2009-115/000-023</a>
	<b>N° art.: 2009-115/000-024</b> WMB-Inline; pour smartPRINTER; sur rouleau; extensible 5 - 5,2 MM; vierge; encliquetable	<a href="http://www.wago.com/2009-115/000-024">www.wago.com/2009-115/000-024</a>
	<b>N° art.: 2009-135</b> WMB-Inline; pour smartPRINTER; sur rouleau; extensible 5 - 5,2 MM; vierge; encliquetable	<a href="http://www.wago.com/2009-135">www.wago.com/2009-135</a>
	<b>N° art.: 2009-145</b> Mini-WSB Inline; pour smartPRINTER; sur rouleau; extensible 5 - 5,2 MM; vierge; encliquetable	<a href="http://www.wago.com/2009-145">www.wago.com/2009-145</a>
	<b>N° art.: 2009-145/000-002</b> Mini-WSB Inline; sur rouleau; extensible 5 - 5,2 MM; vierge; encliquetable	<a href="http://www.wago.com/2009-145/000-002">www.wago.com/2009-145/000-002</a>
	<b>N° art.: 2009-145/000-005</b> Mini-WSB Inline; vierge; 1700 étiquettes Mini-WSB (5 mm) sur rouleau; extensible 5 - 5,2 MM	<a href="http://www.wago.com/2009-145/000-005">www.wago.com/2009-145/000-005</a>
	<b>N° art.: 2009-145/000-006</b> Mini-WSB Inline; pour smartPRINTER; sur rouleau; extensible 5 - 5,2 MM; vierge; encliquetable	<a href="http://www.wago.com/2009-145/000-006">www.wago.com/2009-145/000-006</a>
	<b>N° art.: 2009-145/000-007</b> Mini-WSB Inline; vierge; 1700 étiquettes Mini-WSB (5 mm) sur rouleau; extensible 5 - 5,2 MM	<a href="http://www.wago.com/2009-145/000-007">www.wago.com/2009-145/000-007</a>
	<b>N° art.: 2009-145/000-012</b> Mini-WSB Inline; pour smartPRINTER; sur rouleau; extensible 5 - 5,2 MM; vierge; encliquetable	<a href="http://www.wago.com/2009-145/000-012">www.wago.com/2009-145/000-012</a>

	<b>N° art.: 2009-145/000-023</b> Mini-WSB Inline; sur rouleau; extensible 5 - 5,2 MM; vierge; encliquetable	<a href="http://www.wago.com/2009-145/000-023">www.wago.com/2009-145/000-023</a>
	<b>N° art.: 2009-145/000-024</b> Mini-WSB Inline; sur rouleau; extensible 5 - 5,2 MM; vierge; encliquetable	<a href="http://www.wago.com/2009-145/000-024">www.wago.com/2009-145/000-024</a>
	<b>N° art.: 2009-191</b> Porte-étiquettes de groupe	<a href="http://www.wago.com/2009-191">www.wago.com/2009-191</a>
	<b>N° art.: 2009-192</b> Porte-étiquettes de groupe	<a href="http://www.wago.com/2009-192">www.wago.com/2009-192</a>
	<b>N° art.: 2009-193</b> Porte-étiquettes de groupe	<a href="http://www.wago.com/2009-193">www.wago.com/2009-193</a>
	<b>N° art.: 2009-198</b> Adaptateur	<a href="http://www.wago.com/2009-198">www.wago.com/2009-198</a>
	<b>N° art.: 248-501</b> Système de repérage rapide Mini-WSB; vierge; Largeur d'étiquettes 5 mm; 10 bandes à 10 étiquettes par carte	<a href="http://www.wago.com/248-501">www.wago.com/248-501</a>
	<b>N° art.: 248-501/000-002</b> Carte de repérage mini WSB; en carte; non extensible; vierge; encliquetable	<a href="http://www.wago.com/248-501/000-002">www.wago.com/248-501/000-002</a>
	<b>N° art.: 248-501/000-005</b> Carte de repérage mini WSB; en carte; vierge; encliquetable	<a href="http://www.wago.com/248-501/000-005">www.wago.com/248-501/000-005</a>
	<b>N° art.: 248-501/000-006</b> Carte de repérage mini WSB; en carte; non extensible; vierge; encliquetable	<a href="http://www.wago.com/248-501/000-006">www.wago.com/248-501/000-006</a>
	<b>N° art.: 248-501/000-007</b> Carte de repérage mini WSB; en carte; non extensible; vierge; encliquetable	<a href="http://www.wago.com/248-501/000-007">www.wago.com/248-501/000-007</a>
	<b>N° art.: 248-501/000-012</b> Carte de repérage mini WSB; en carte; non extensible; vierge; encliquetable	<a href="http://www.wago.com/248-501/000-012">www.wago.com/248-501/000-012</a>
	<b>N° art.: 248-501/000-017</b> Carte de repérage mini WSB; en carte; non extensible; vierge; encliquetable	<a href="http://www.wago.com/248-501/000-017">www.wago.com/248-501/000-017</a>
	<b>N° art.: 248-501/000-023</b> Carte de repérage mini WSB; en carte; non extensible; vierge; encliquetable	<a href="http://www.wago.com/248-501/000-023">www.wago.com/248-501/000-023</a>
	<b>N° art.: 248-501/000-024</b> Carte de repérage mini WSB; en carte; non extensible; vierge; encliquetable	<a href="http://www.wago.com/248-501/000-024">www.wago.com/248-501/000-024</a>
	<b>N° art.: 793-501</b> Carte de repérage WMB; en carte; non extensible; vierge; encliquetable	<a href="http://www.wago.com/793-501">www.wago.com/793-501</a>



**N° art.: 793-501/000-002**  
Carte de repérage WMB; en carte; non extensible; vierge; encliquetable

[www.wago.com/793-501/000-002](http://www.wago.com/793-501/000-002)



**N° art.: 793-501/000-005**  
Carte de repérage WMB; en carte; non extensible; vierge; encliquetable

[www.wago.com/793-501/000-005](http://www.wago.com/793-501/000-005)



**N° art.: 793-501/000-006**  
Carte de repérage WMB; en carte; non extensible; vierge; encliquetable

[www.wago.com/793-501/000-006](http://www.wago.com/793-501/000-006)



**N° art.: 793-501/000-007**  
Carte de repérage WMB; en carte; non extensible; vierge; encliquetable

[www.wago.com/793-501/000-007](http://www.wago.com/793-501/000-007)



**N° art.: 793-501/000-012**  
Carte de repérage WMB; en carte; non extensible; vierge; encliquetable

[www.wago.com/793-501/000-012](http://www.wago.com/793-501/000-012)



**N° art.: 793-501/000-017**  
Carte de repérage WMB; en carte; non extensible; vierge; encliquetable

[www.wago.com/793-501/000-017](http://www.wago.com/793-501/000-017)



**N° art.: 793-501/000-023**  
Carte de repérage WMB; en carte; non extensible; vierge; encliquetable

[www.wago.com/793-501/000-023](http://www.wago.com/793-501/000-023)



**N° art.: 793-501/000-024**  
Carte de repérage WMB; en carte; non extensible; vierge; encliquetable

[www.wago.com/793-501/000-024](http://www.wago.com/793-501/000-024)



**N° art.: 793-5501**  
Carte de repérage WMB; en carte; largeur des bornes 5 - 17,5 mm; extensible 5 - 5,2 MM; vierge; encliquetable

[www.wago.com/793-5501](http://www.wago.com/793-5501)



**N° art.: 793-5501/000-002**  
Carte de repérage WMB; en carte; largeur des bornes 5 - 17,5 mm; extensible 5 - 5,2 MM; vierge; encliquetable

[www.wago.com/793-5501/000-002](http://www.wago.com/793-5501/000-002)



**N° art.: 793-5501/000-005**  
Carte de repérage WMB; en carte; extensible 5 - 5,2 MM; vierge; encliquetable

[www.wago.com/793-5501/000-005](http://www.wago.com/793-5501/000-005)



**N° art.: 793-5501/000-006**  
Carte de repérage WMB; en carte; extensible 5 - 5,2 MM; vierge; encliquetable

[www.wago.com/793-5501/000-006](http://www.wago.com/793-5501/000-006)



**N° art.: 793-5501/000-007**  
Carte de repérage WMB; en carte; extensible 5 - 5,2 MM; vierge; encliquetable

[www.wago.com/793-5501/000-007](http://www.wago.com/793-5501/000-007)



**N° art.: 793-5501/000-012**  
Carte de repérage WMB; en carte; extensible 5 - 5,2 MM; vierge; encliquetable

[www.wago.com/793-5501/000-012](http://www.wago.com/793-5501/000-012)



**N° art.: 793-5501/000-017**  
Carte de repérage WMB; en carte; extensible 5 - 5,2 MM; vierge; encliquetable

[www.wago.com/793-5501/000-017](http://www.wago.com/793-5501/000-017)





N° art.: 793-5501/000-023

Carte de repérage WMB; en carte; extensible 5 - 5,2 MM; vierge; encliquetable

[www.wago.com/793-5501/000-023](http://www.wago.com/793-5501/000-023)

N° art.: 793-5501/000-024

Carte de repérage WMB; en carte; extensible 5 - 5,2 MM; vierge; encliquetable

[www.wago.com/793-5501/000-024](http://www.wago.com/793-5501/000-024)

## ferrule



N° art.: 216-262

Embout d'extrémité; embout pour 0,75 mm<sup>2</sup> / AWG 20; avec isolation plastique; étamés par électrolyse; Cuivre électrolytique; serti de manière étanche aux gaz; selon DIN 46228, partie 4/09.90[www.wago.com/216-262](http://www.wago.com/216-262)

N° art.: 216-263

Embout d'extrémité; embout pour 1 mm<sup>2</sup> / AWG 18; avec isolation plastique; étamés par électrolyse; Cuivre électrolytique; serti de manière étanche aux gaz; selon DIN 46228, partie 4/09.90[www.wago.com/216-263](http://www.wago.com/216-263)

N° art.: 216-264

Embout d'extrémité; embout pour 1,5 mm<sup>2</sup> / AWG 16; avec isolation plastique; étamés par électrolyse; Cuivre électrolytique; serti de manière étanche aux gaz; selon DIN 46228, partie 4/09.90[www.wago.com/216-264](http://www.wago.com/216-264)

N° art.: 216-266

Embout d'extrémité; embout pour 2,5 mm<sup>2</sup> / AWG 14; avec isolation plastique; étamés par électrolyse; Cuivre électrolytique; serti de manière étanche aux gaz; selon DIN 46228, partie 4/09.90[www.wago.com/216-266](http://www.wago.com/216-266)

N° art.: 216-267

Embout d'extrémité; embout pour 4 mm<sup>2</sup> / AWG 12; avec isolation plastique; étamés par électrolyse; Cuivre électrolytique; serti de manière étanche aux gaz; selon DIN 46228, partie 4/09.90[www.wago.com/216-267](http://www.wago.com/216-267)

## Protective Warning Marker



N° art.: 2004-115

Obturbateur de protection avec signalisation de danger; avec signalisation de danger; pour 5 bornes

[www.wago.com/2004-115](http://www.wago.com/2004-115)

## Insulation stop



N° art.: 2004-171

Réducteur isolant de sécurité; 0,25 - 0,5 mm<sup>2</sup>; 5 pièces/bande[www.wago.com/2004-171](http://www.wago.com/2004-171)

N° art.: 2004-172

Réducteur isolant de sécurité; 0,75 - 1 mm<sup>2</sup>; 5 pièces/bande[www.wago.com/2004-172](http://www.wago.com/2004-172)

## End plate



N° art.: 2004-1291

Plaque d'extrémité et intermédiaire; épaisseur 1 mm

[www.wago.com/2004-1291](http://www.wago.com/2004-1291)

N° art.: 2004-1292

Plaque d'extrémité et intermédiaire; épaisseur 1 mm

[www.wago.com/2004-1292](http://www.wago.com/2004-1292)

N° art.: 2004-1293

Séparateur; épaisseur 2 mm; en saillie

[www.wago.com/2004-1293](http://www.wago.com/2004-1293)

N° art.: 2004-1294

Séparateur; épaisseur 2 mm; en saillie

[www.wago.com/2004-1294](http://www.wago.com/2004-1294)

N° art.: 209-190

Séparateur Ex e/Ex i; épaisseur 3 mm; Largeur 90 mm

[www.wago.com/209-190](http://www.wago.com/209-190)



**N° art.: 209-191**  
Séparateur Ex e/Ex i; épaisseur 3 mm; Largeur 120 mm

[www.wago.com/209-191](http://www.wago.com/209-191)

#### Carrier rail



**N° art.: 210-112**  
Rail acier; 35 x 7,5; épaisseur 1 mm; longueur 2 m; perforé; d'après EN 60715; Largeur de trou 25 mm; pas des trous 36 mm

[www.wago.com/210-112](http://www.wago.com/210-112)



**N° art.: 210-113**  
Rail acier; 35 x 7,5; épaisseur 1 mm; longueur 2 m; non perforé; d'après EN 60715

[www.wago.com/210-113](http://www.wago.com/210-113)



**N° art.: 210-114**  
Rail acier; 35 x 15; épaisseur 1,5 mm; longueur 2 m; non perforé; d'après EN 60715

[www.wago.com/210-114](http://www.wago.com/210-114)



**N° art.: 210-115**  
Rail acier; 35 x 7,5; épaisseur 1 mm; longueur 2 m; perforé; d'après EN 60715; Largeur de trou 18 mm; pas des trous 25 mm

[www.wago.com/210-115](http://www.wago.com/210-115)



**N° art.: 210-118**  
Rail acier; 35 x 15; épaisseur 2,3 mm; longueur 2 m; non perforé; d'après EN 60715

[www.wago.com/210-118](http://www.wago.com/210-118)



**N° art.: 210-196**  
Rail aluminium; 35 x 8,2; épaisseur 1,6 mm; longueur 2 m; non perforé; d'après EN 60715

[www.wago.com/210-196](http://www.wago.com/210-196)



**N° art.: 210-197**  
Rail acier; 35 x 15; épaisseur 1,5 mm; longueur 2 m; perforé; d'après EN 60715

[www.wago.com/210-197](http://www.wago.com/210-197)



**N° art.: 210-198**  
Rail en cuivre; 35 x 15; épaisseur 2,3 mm; longueur 2 m; non perforé; d'après EN 60715

[www.wago.com/210-198](http://www.wago.com/210-198)

#### check



**N° art.: 2004-511**  
Connecteur modulaire TOPJOB® S; modulaires; pour fentes de pontage; 1 pôle

[www.wago.com/2004-511](http://www.wago.com/2004-511)



**N° art.: 2004-549**  
Module vide; modulaires; pour sauter p.ex. des bornes pontées

[www.wago.com/2004-549](http://www.wago.com/2004-549)



**N° art.: 2004-552**  
Connecteur femelle TOPJOB® S; pour fentes de pontage; 2 pôles

[www.wago.com/2004-552](http://www.wago.com/2004-552)



**N° art.: 2004-553**  
Connecteur femelle TOPJOB® S; pour fentes de pontage; 3 pôles

[www.wago.com/2004-553](http://www.wago.com/2004-553)



**N° art.: 2004-554**  
Connecteur femelle TOPJOB® S; pour fentes de pontage; 4 pôles

[www.wago.com/2004-554](http://www.wago.com/2004-554)



**N° art.: 2004-555**  
Connecteur femelle TOPJOB® S; pour fentes de pontage; 5 pôles

[www.wago.com/2004-555](http://www.wago.com/2004-555)



**N° art.: 2009-174**  
Adaptateur de test; pour fiche de test Ø 4 mm; pour tester les bornes sur rail TOPJOB®S

[www.wago.com/2009-174](http://www.wago.com/2009-174)



**N° art.: 2009-182**  
Prise de test; pour max. 2,5 mm<sup>2</sup>; pour le raccordement sans outil des conducteurs de contrôle individuels de 0,08

[www.wago.com/2009-182](http://www.wago.com/2009-182)



## Téléchargements

### Documentation

#### Bid Text

2004-1206 Reihenklemmen, TOPJOB S	Aug 13, 2018	DOCX 15,0 kB	Téléchargement
--------------------------------------	--------------	-----------------	----------------

---

## smartDATA

### CAD data

3D Download 2004-1206		URL	Téléchargement
-----------------------	--	-----	----------------

---

Sous réserve de modifications.