

# Fiche technique | Numéro d'article: 2004-1305

Borne de passage pour 3 conducteurs; 4 mm<sup>2</sup>; pour applications Ex e II;  
Marquage latéral et central; Pour rail 35 x 15 et 35 x 7,5; Push-in CAGE  
CLAMP®

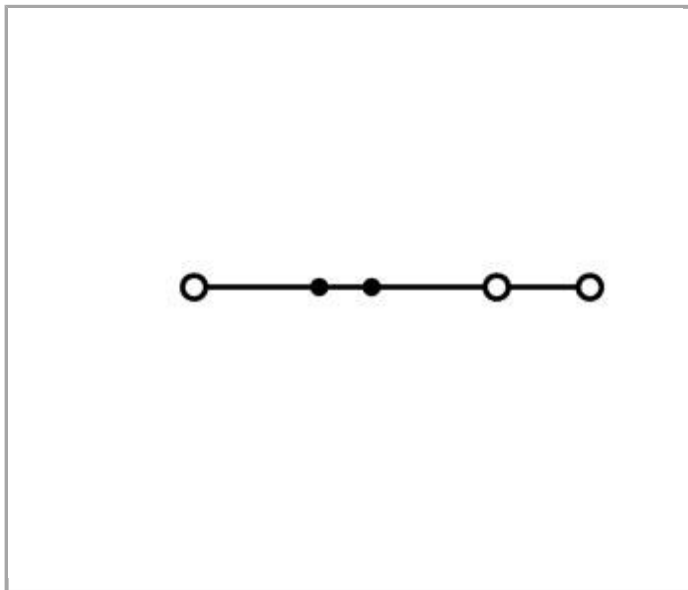

[www.wago.com/2004-1305](http://www.wago.com/2004-1305)

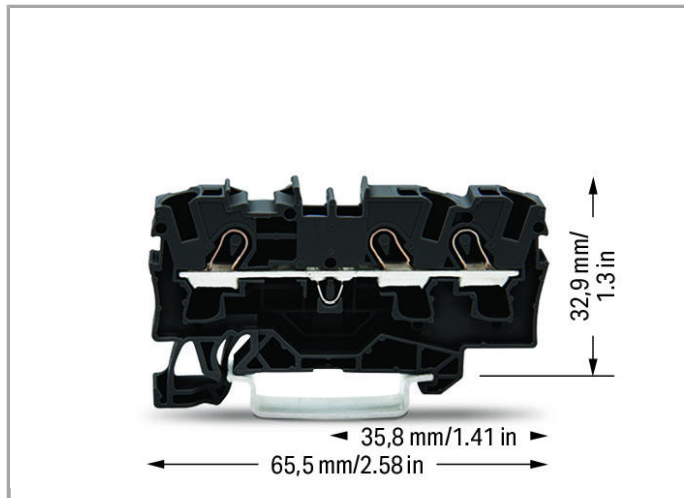
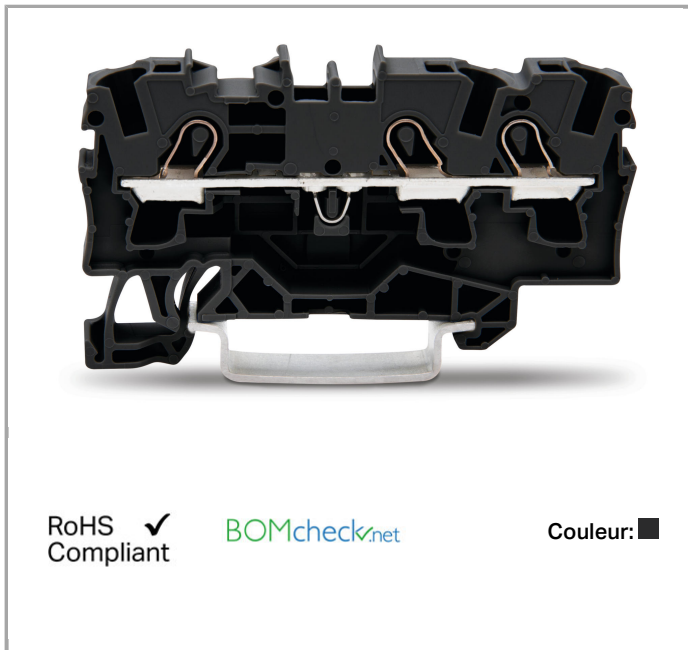

## Données

### Données électriques

Tension de référence EN (Ex e II)	550 V
Courant de référence (Ex e II)	30 A

### Ratings per IEC/EN 60664-1

Tension de référence (III / 3)	800 V
Tension assignée de tenue aux chocs (III / 3)	8 kV
Courant	32 A
Courant de référence 2	41 A
Légende Données de référence	(III / 3) ≙ Catégorie de surtension III / degré de pollution 3

### Approvals per UL 1059

Tension de référence UL (Use Group B)	600 V
Courant de référence UL (Use Group B)	30 A
Tension de référence UL (Use Group C)	600 V
Courant de référence UL (Use Group C)	30 A

### Approvals per CSA

Tension de référence CSA (Use Group B)	600 V
Courant de référence CSA (Use Group B)	30 A
Tension de référence CSA (Use Group C)	600 V
Courant de référence CSA (Use Group C)	30 A

### Données de raccordement

Technique de connexion	Push-in CAGE CLAMP®
Type d'actionnement	Push-in Outil de manipulation
Matière plastique conducteur raccordable	Cuivre
Section nominale :	4 mm <sup>2</sup>
Conducteur rigide	0,5 ... 6 mm <sup>2</sup> / 20 ... 10 AWG
Conducteur rigide, enfichage direct	1,5 ... 6 mm <sup>2</sup> / 14 ... 10 AWG
Conducteur souple	0,5 ... 6 mm <sup>2</sup> / 20 ... 10 AWG
conducteur souple avec embout d'extrémité, directement enfichable à partir de	1,5 mm <sup>2</sup> / 18 AWG
Longueur de dénudage	11 ... 13 mm / 0.43 ... 0.51 inch
Nombre total des points de serrage	3
Nombre total des potentiels	1
nombre des niveaux	1
Type de câblage	câblage frontal

### Données géométriques

Largeur	6,2 mm / 0.244 inch
Profondeur à partir du niveau supérieur du rail	32,9 mm / 1.295 inch

Profondeur	65,5 mm / 2.579 inch
------------	----------------------

### Données mécaniques

Mode de construction	type horizontal
Type de montage	Rail 35
Niveau de marquage	Marquage central/latéral

### Données du matériau



Couleur	noir
Matière isolante	Polyamide 66 (PA 66)
Charge calorifique	0.15 MJ
Poids	8.37 g

### Dates commerciales

Country of origin	DE
GTIN	4045454537470
Customs Tariff No.	85369010000
Product Group	22 (TOPJOB S)

### Autorisations / certificats

#### Ex-approbations

Logo	Approbation	Nom du certificat
	AEx Underwriters Laboratories Inc.	E185892
	ATEX Physikalisch Technische Bundesanstalt (PTB)	PTB 05 ATEX 1095 U (II 2 G/D Ex eII bzw. I M2 Ex el)

#### Approbations spécifiques au pays

Logo	Approbation	Nom du certificat
	CCA DEKRA Certification B.V.	2160584.10
	CCA DEKRA Certification B.V.	NTR NL-7088
	CSA DEKRA Certification B.V.	1645435



## Approbations de navire

Logo	Approbation	Nom du certificat
<b>ABS</b>	ABS American Bureau of Shipping	14-HG1293677-PDA
<b>BV</b>	BV Bureau Veritas S.A.	38586/A0 BV
	LR Lloyds Register	91/20112 (E9)

## Approbations UL





Logo	Approbation	Nom du certificat
	UL UL International Germany GmbH	E45172

## Produits correspondants

## Protective Warning Marker

	N° art.: 2004-115 Obturbateur de protection avec signalisation de danger; avec signalisation de danger; pour 5 bornes	<a href="http://www.wago.com/2004-115">www.wago.com/2004-115</a>
--	--	--

## ferrule

	N° art.: 216-262 Embout d'extrémité; embout pour 0,75 mm <sup>2</sup> / AWG 20; avec isolation plastique; étamés par électrolyse; Cuivre électrolytique; serti de manière étanche aux gaz; selon DIN 46228, partie 4/09.90	<a href="http://www.wago.com/216-262">www.wago.com/216-262</a>
	N° art.: 216-263 Embout d'extrémité; embout pour 1 mm <sup>2</sup> / AWG 18; avec isolation plastique; étamés par électrolyse; Cuivre électrolytique; serti de manière étanche aux gaz; selon DIN 46228, partie 4/09.90	<a href="http://www.wago.com/216-263">www.wago.com/216-263</a>
	N° art.: 216-264 Embout d'extrémité; embout pour 1,5 mm <sup>2</sup> / AWG 16; avec isolation plastique; étamés par électrolyse; Cuivre électrolytique; serti de manière étanche aux gaz; selon DIN 46228, partie 4/09.90	<a href="http://www.wago.com/216-264">www.wago.com/216-264</a>
	N° art.: 216-266 Embout d'extrémité; embout pour 2,5 mm <sup>2</sup> / AWG 14; avec isolation plastique; étamés par électrolyse; Cuivre électrolytique; serti de manière étanche aux gaz; selon DIN 46228, partie 4/09.90	<a href="http://www.wago.com/216-266">www.wago.com/216-266</a>
	N° art.: 216-267 Embout d'extrémité; embout pour 4 mm <sup>2</sup> / AWG 12; avec isolation plastique; étamés par électrolyse; Cuivre électrolytique; serti de manière étanche aux gaz; selon DIN 46228, partie 4/09.90	<a href="http://www.wago.com/216-267">www.wago.com/216-267</a>

## tools



N° art.: 210-658

Outil de manipulation, partiellement isolé; Lame (3,5 x 0,5) mm; court; Coudé

[www.wago.com/210-658](http://www.wago.com/210-658)

N° art.: 210-720

Outil de manipulation, partiellement isolé; Type 2, lame (3,5 x 0,5) mm

[www.wago.com/210-720](http://www.wago.com/210-720)

## Insulation stop



N° art.: 2004-171

Réducteur isolant de sécurité; 0,25 - 0,5 mm<sup>2</sup>; 5 pièces/bande[www.wago.com/2004-171](http://www.wago.com/2004-171)

N° art.: 2004-172

Réducteur isolant de sécurité; 0,75 - 1 mm<sup>2</sup>; 5 pièces/bande[www.wago.com/2004-172](http://www.wago.com/2004-172)

## Jumper



N° art.: 2004-402

Peigne de pontage; isolé; 2 raccords; Courant nominal 32 A

[www.wago.com/2004-402](http://www.wago.com/2004-402)

N° art.: 2004-403

Peigne de pontage; isolé; 3 raccords; Courant nominal 32 A

[www.wago.com/2004-403](http://www.wago.com/2004-403)

N° art.: 2004-404

Peigne de pontage; isolé; 4 raccords; Courant nominal 32 A

[www.wago.com/2004-404](http://www.wago.com/2004-404)

N° art.: 2004-405

Peigne de pontage; isolé; 5 raccords; Courant nominal 32 A

[www.wago.com/2004-405](http://www.wago.com/2004-405)

N° art.: 2004-405/011-000

Contact de pontage en étoile; isolé; 3 pôles (1-3-5); IN = IN borne

[www.wago.com/2004-405/011-000](http://www.wago.com/2004-405/011-000)

N° art.: 2004-406

Peigne de pontage; isolé; 6 raccords; Courant nominal 32 A

[www.wago.com/2004-406](http://www.wago.com/2004-406)

N° art.: 2004-406/020-000

Contact de pontage sous forme de triangle; isolé; 1-2 3-4 5-6; IN = IN borne

[www.wago.com/2004-406/020-000](http://www.wago.com/2004-406/020-000)

N° art.: 2004-407

Peigne de pontage; isolé; 7 raccords; Courant nominal 32 A

[www.wago.com/2004-407](http://www.wago.com/2004-407)

N° art.: 2004-408

Peigne de pontage; isolé; 8 raccords; Courant nominal 32 A

[www.wago.com/2004-408](http://www.wago.com/2004-408)

N° art.: 2004-409

Peigne de pontage; isolé; 9 raccords; Courant nominal 32 A

[www.wago.com/2004-409](http://www.wago.com/2004-409)

N° art.: 2004-410

Peigne de pontage; isolé; 10 raccords; Courant nominal 32 A

[www.wago.com/2004-410](http://www.wago.com/2004-410)

N° art.: 2004-433















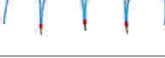

Peigne de pontage; isolé; de 1 à 3; Courant nominal 32 A

[www.wago.com/2004-433](http://www.wago.com/2004-433)

N° art.: 2004-434

Peigne de pontage; isolé; de 1 à 4; Courant nominal 32 A

[www.wago.com/2004-434](http://www.wago.com/2004-434)

	<b>N° art.: 2004-435</b> Peigne de pontage; isolé; de 1 à 5; Courant nominal 32 A	<a href="http://www.wago.com/2004-435">www.wago.com/2004-435</a>
	<b>N° art.: 2004-436</b> Peigne de pontage; isolé; de 1 à 6; Courant nominal 32 A	<a href="http://www.wago.com/2004-436">www.wago.com/2004-436</a>
	<b>N° art.: 2004-437</b> Peigne de pontage; isolé; de 1 à 7; Courant nominal 32 A	<a href="http://www.wago.com/2004-437">www.wago.com/2004-437</a>
	<b>N° art.: 2004-438</b> Peigne de pontage; isolé; de 1 à 8; Courant nominal 32 A	<a href="http://www.wago.com/2004-438">www.wago.com/2004-438</a>
	<b>N° art.: 2004-439</b> Peigne de pontage; isolé; de 1 à 9; Courant nominal 32 A	<a href="http://www.wago.com/2004-439">www.wago.com/2004-439</a>
	<b>N° art.: 2004-440</b> Peigne de pontage; isolé; de 1 à 10; Courant nominal 32 A	<a href="http://www.wago.com/2004-440">www.wago.com/2004-440</a>
	<b>N° art.: 2006-499</b> Contact de pontage réducteur; isolé; de 6/4 mm <sup>2</sup> a 4/2,5/1,5 mm <sup>2</sup> ; Courant nominal 32 A	<a href="http://www.wago.com/2006-499">www.wago.com/2006-499</a>
	<b>N° art.: 2016-499</b> Contact de pontage réducteur; isolé; de 16/10 mm <sup>2</sup> à 10/6/4/2,5 mm <sup>2</sup> ; Courant nominal 57 A	<a href="http://www.wago.com/2016-499">www.wago.com/2016-499</a>
	<b>N° art.: 210-103</b> Chaîne de pontage en fil; isolé; 50 raccords	<a href="http://www.wago.com/210-103">www.wago.com/210-103</a>
	<b>N° art.: 210-123</b> Chaîne de pontage en fil; isolé; 50 raccords	<a href="http://www.wago.com/210-123">www.wago.com/210-123</a>
<b>End plate</b>		
	<b>N° art.: 2004-1391</b> Plaque d'extrémité et intermédiaire; épaisseur 1 mm	<a href="http://www.wago.com/2004-1391">www.wago.com/2004-1391</a>
	<b>N° art.: 2004-1392</b> Plaque d'extrémité et intermédiaire; épaisseur 1 mm	<a href="http://www.wago.com/2004-1392">www.wago.com/2004-1392</a>
	<b>N° art.: 2004-1393</b> Séparateur; épaisseur 2 mm; en saillie	<a href="http://www.wago.com/2004-1393">www.wago.com/2004-1393</a>
	<b>N° art.: 2004-1394</b> Séparateur; épaisseur 2 mm; en saillie	<a href="http://www.wago.com/2004-1394">www.wago.com/2004-1394</a>
	<b>N° art.: 209-191</b> Séparateur Ex e/Ex i; épaisseur 3 mm; Largeur 120 mm	<a href="http://www.wago.com/209-191">www.wago.com/209-191</a>
<b>check</b>		
	<b>N° art.: 2004-511</b> Connecteur modulaire TOPJOB® S; modulaires; pour fentes de pontage; 1 pôle	<a href="http://www.wago.com/2004-511">www.wago.com/2004-511</a>
	<b>N° art.: 2004-549</b> Module vide; modulaires; pour sauter p.ex. des bornes pontées	<a href="http://www.wago.com/2004-549">www.wago.com/2004-549</a>
	<b>N° art.: 2004-552</b> Connecteur femelle TOPJOB® S; pour fentes de pontage; 2 pôles	<a href="http://www.wago.com/2004-552">www.wago.com/2004-552</a>



**N° art.: 2004-553**  
Connecteur femelle TOPJOB® S; pour fentes de pontage; 3 pôles

[www.wago.com/2004-553](http://www.wago.com/2004-553)



**N° art.: 2004-554**  
Connecteur femelle TOPJOB® S; pour fentes de pontage; 4 pôles

[www.wago.com/2004-554](http://www.wago.com/2004-554)



**N° art.: 2004-555**  
Connecteur femelle TOPJOB® S; pour fentes de pontage; 5 pôles

[www.wago.com/2004-555](http://www.wago.com/2004-555)



**N° art.: 2009-174**  
Adaptateur de test; pour fiche de test Ø 4 mm; pour tester les bornes sur rail TOPJOB®S

[www.wago.com/2009-174](http://www.wago.com/2009-174)



**N° art.: 2009-182**  
Prise de test; pour max. 2,5 mm<sup>2</sup>; pour le raccordement sans outil des conducteurs de contrôle individuels de 0,08

[www.wago.com/2009-182](http://www.wago.com/2009-182)

### Carrier rail



**N° art.: 210-112**  
Rail acier; 35 x 7,5; épaisseur 1 mm; longueur 2 m; perforé; d'après EN 60715; Largeur de trou 25 mm; pas des trous 36 mm

[www.wago.com/210-112](http://www.wago.com/210-112)



**N° art.: 210-113**  
Rail acier; 35 x 7,5; épaisseur 1 mm; longueur 2 m; non perforé; d'après EN 60715

[www.wago.com/210-113](http://www.wago.com/210-113)



**N° art.: 210-114**  
Rail acier; 35 x 15; épaisseur 1,5 mm; longueur 2 m; non perforé; d'après EN 60715

[www.wago.com/210-114](http://www.wago.com/210-114)



**N° art.: 210-115**  
Rail acier; 35 x 7,5; épaisseur 1 mm; longueur 2 m; perforé; d'après EN 60715; Largeur de trou 18 mm; pas des trous 25 mm

[www.wago.com/210-115](http://www.wago.com/210-115)



**N° art.: 210-118**  
Rail acier; 35 x 15; épaisseur 2,3 mm; longueur 2 m; non perforé; d'après EN 60715

[www.wago.com/210-118](http://www.wago.com/210-118)



**N° art.: 210-196**  
Rail aluminium; 35 x 8,2; épaisseur 1,6 mm; longueur 2 m; non perforé; d'après EN 60715

[www.wago.com/210-196](http://www.wago.com/210-196)



**N° art.: 210-197**  
Rail acier; 35 x 15; épaisseur 1,5 mm; longueur 2 m; perforé; d'après EN 60715

[www.wago.com/210-197](http://www.wago.com/210-197)



**N° art.: 210-198**  
Rail en cuivre; 35 x 15; épaisseur 2,3 mm; longueur 2 m; non perforé; d'après EN 60715

[www.wago.com/210-198](http://www.wago.com/210-198)

### Marking accessories



**N° art.: 2009-110**  
Bandes de marquage; sur rouleau; non extensible; vierge; encliquetable

[www.wago.com/2009-110](http://www.wago.com/2009-110)



**N° art.: 2009-115**  
WMB-Inline; pour smartPRINTER; sur rouleau; extensible 5 - 5,2 MM; vierge; encliquetable

[www.wago.com/2009-115](http://www.wago.com/2009-115)



















**N° art.: 2009-115/000-002**  
WMB-Inline; pour smartPRINTER; sur rouleau; extensible 5 - 5,2 MM; vierge; encliquetable

[www.wago.com/2009-115/000-002](http://www.wago.com/2009-115/000-002)



**N° art.: 2009-115/000-006**  
WMB-Inline; pour smartPRINTER; sur rouleau; extensible 5 - 5,2 MM; vierge; encliquetable

[www.wago.com/2009-115/000-006](http://www.wago.com/2009-115/000-006)

	<b>N° art.: 2009-115/000-007</b> WMB-Inline; sur rouleau; extensible 5 - 5,2 MM; vierge; encliquetable	<a href="http://www.wago.com/2009-115/000-007">www.wago.com/2009-115/000-007</a>
	<b>N° art.: 2009-115/000-012</b> WMB-Inline; pour smartPRINTER; sur rouleau; extensible 5 - 5,2 MM; vierge; encliquetable	<a href="http://www.wago.com/2009-115/000-012">www.wago.com/2009-115/000-012</a>
	<b>N° art.: 2009-115/000-017</b> WMB-Inline; sur rouleau; extensible 5 - 5,2 MM; vierge; encliquetable	<a href="http://www.wago.com/2009-115/000-017">www.wago.com/2009-115/000-017</a>
	<b>N° art.: 2009-115/000-023</b> WMB-Inline; pour smartPRINTER; sur rouleau; extensible 5 - 5,2 MM; vierge; encliquetable	<a href="http://www.wago.com/2009-115/000-023">www.wago.com/2009-115/000-023</a>
	<b>N° art.: 2009-115/000-024</b> WMB-Inline; pour smartPRINTER; sur rouleau; extensible 5 - 5,2 MM; vierge; encliquetable	<a href="http://www.wago.com/2009-115/000-024">www.wago.com/2009-115/000-024</a>
	<b>N° art.: 2009-135</b> WMB-Inline; pour smartPRINTER; sur rouleau; extensible 5 - 5,2 MM; vierge; encliquetable	<a href="http://www.wago.com/2009-135">www.wago.com/2009-135</a>
	<b>N° art.: 2009-145</b> Mini-WSB Inline; pour smartPRINTER; sur rouleau; extensible 5 - 5,2 MM; vierge; encliquetable	<a href="http://www.wago.com/2009-145">www.wago.com/2009-145</a>
	<b>N° art.: 2009-145/000-002</b> Mini-WSB Inline; sur rouleau; extensible 5 - 5,2 MM; vierge; encliquetable	<a href="http://www.wago.com/2009-145/000-002">www.wago.com/2009-145/000-002</a>
	<b>N° art.: 2009-145/000-005</b> Mini-WSB Inline; vierge; 1700 étiquettes Mini-WSB (5 mm) sur rouleau; extensible 5 - 5,2 MM	<a href="http://www.wago.com/2009-145/000-005">www.wago.com/2009-145/000-005</a>
	<b>N° art.: 2009-145/000-006</b> Mini-WSB Inline; pour smartPRINTER; sur rouleau; extensible 5 - 5,2 MM; vierge; encliquetable	<a href="http://www.wago.com/2009-145/000-006">www.wago.com/2009-145/000-006</a>
	<b>N° art.: 2009-145/000-007</b> Mini-WSB Inline; vierge; 1700 étiquettes Mini-WSB (5 mm) sur rouleau; extensible 5 - 5,2 MM	<a href="http://www.wago.com/2009-145/000-007">www.wago.com/2009-145/000-007</a>
	<b>N° art.: 2009-145/000-012</b> Mini-WSB Inline; pour smartPRINTER; sur rouleau; extensible 5 - 5,2 MM; vierge; encliquetable	<a href="http://www.wago.com/2009-145/000-012">www.wago.com/2009-145/000-012</a>
	<b>N° art.: 2009-145/000-023</b> Mini-WSB Inline; sur rouleau; extensible 5 - 5,2 MM; vierge; encliquetable	<a href="http://www.wago.com/2009-145/000-023">www.wago.com/2009-145/000-023</a>
	<b>N° art.: 2009-145/000-024</b> Mini-WSB Inline; sur rouleau; extensible 5 - 5,2 MM; vierge; encliquetable	<a href="http://www.wago.com/2009-145/000-024">www.wago.com/2009-145/000-024</a>
	<b>N° art.: 2009-191</b> Porte-étiquettes de groupe	<a href="http://www.wago.com/2009-191">www.wago.com/2009-191</a>
	<b>N° art.: 2009-192</b> Porte-étiquettes de groupe	<a href="http://www.wago.com/2009-192">www.wago.com/2009-192</a>





**N° art.: 2009-193**  
Porte-étiquettes de groupe

[www.wago.com/2009-193](http://www.wago.com/2009-193)



**N° art.: 2009-198**  
Adaptateur

[www.wago.com/2009-198](http://www.wago.com/2009-198)



**N° art.: 248-501**  
Système de repérage rapide Mini-WSB; vierge; Largeur d'étiquettes 5 mm; 10 bandes à 10 étiquettes par carte

[www.wago.com/248-501](http://www.wago.com/248-501)



**N° art.: 248-501/000-002**  
Carte de repérage mini WSB; en carte; non extensible; vierge; encliquetable

[www.wago.com/248-501/000-002](http://www.wago.com/248-501/000-002)



**N° art.: 248-501/000-005**  
Carte de repérage mini WSB; en carte; vierge; encliquetable

[www.wago.com/248-501/000-005](http://www.wago.com/248-501/000-005)



**N° art.: 248-501/000-006**  
Carte de repérage mini WSB; en carte; non extensible; vierge; encliquetable

[www.wago.com/248-501/000-006](http://www.wago.com/248-501/000-006)



**N° art.: 248-501/000-007**  
Carte de repérage mini WSB; en carte; non extensible; vierge; encliquetable

[www.wago.com/248-501/000-007](http://www.wago.com/248-501/000-007)



**N° art.: 248-501/000-012**  
Carte de repérage mini WSB; en carte; non extensible; vierge; encliquetable

[www.wago.com/248-501/000-012](http://www.wago.com/248-501/000-012)



**N° art.: 248-501/000-017**  
Carte de repérage mini WSB; en carte; non extensible; vierge; encliquetable

[www.wago.com/248-501/000-017](http://www.wago.com/248-501/000-017)



**N° art.: 248-501/000-023**  
Carte de repérage mini WSB; en carte; non extensible; vierge; encliquetable

[www.wago.com/248-501/000-023](http://www.wago.com/248-501/000-023)



**N° art.: 248-501/000-024**  
Carte de repérage mini WSB; en carte; non extensible; vierge; encliquetable

[www.wago.com/248-501/000-024](http://www.wago.com/248-501/000-024)



**N° art.: 793-501**  
Carte de repérage WMB; en carte; non extensible; vierge; encliquetable

[www.wago.com/793-501](http://www.wago.com/793-501)



**N° art.: 793-501/000-002**  
Carte de repérage WMB; en carte; non extensible; vierge; encliquetable

[www.wago.com/793-501/000-002](http://www.wago.com/793-501/000-002)



**N° art.: 793-501/000-005**  
Carte de repérage WMB; en carte; non extensible; vierge; encliquetable

[www.wago.com/793-501/000-005](http://www.wago.com/793-501/000-005)



**N° art.: 793-501/000-006**  
Carte de repérage WMB; en carte; non extensible; vierge; encliquetable

[www.wago.com/793-501/000-006](http://www.wago.com/793-501/000-006)

**N° art.: 793-501/000-007**  
Carte de repérage WMB; en carte; non extensible; vierge; encliquetable

[www.wago.com/793-501/000-007](http://www.wago.com/793-501/000-007)

**N° art.: 793-501/000-012**

Carte de repérage WMB; en carte; non extensible; vierge; encliquetable

[www.wago.com/793-501/000-012](http://www.wago.com/793-501/000-012)**N° art.: 793-501/000-017**

Carte de repérage WMB; en carte; non extensible; vierge; encliquetable

[www.wago.com/793-501/000-017](http://www.wago.com/793-501/000-017)**N° art.: 793-501/000-023**

Carte de repérage WMB; en carte; non extensible; vierge; encliquetable

[www.wago.com/793-501/000-023](http://www.wago.com/793-501/000-023)**N° art.: 793-501/000-024**

Carte de repérage WMB; en carte; non extensible; vierge; encliquetable

[www.wago.com/793-501/000-024](http://www.wago.com/793-501/000-024)**N° art.: 793-5501**

Carte de repérage WMB; en carte; largeur des bornes 5 - 17,5 mm; extensible 5 - 5,2 MM; vierge; encliquetable

[www.wago.com/793-5501](http://www.wago.com/793-5501)**N° art.: 793-5501/000-002**

Carte de repérage WMB; en carte; largeur des bornes 5 - 17,5 mm; extensible 5 - 5,2 MM; vierge; encliquetable

[www.wago.com/793-5501/000-002](http://www.wago.com/793-5501/000-002)**N° art.: 793-5501/000-005**

Carte de repérage WMB; en carte; extensible 5 - 5,2 MM; vierge; encliquetable

[www.wago.com/793-5501/000-005](http://www.wago.com/793-5501/000-005)**N° art.: 793-5501/000-006**

Carte de repérage WMB; en carte; extensible 5 - 5,2 MM; vierge; encliquetable

[www.wago.com/793-5501/000-006](http://www.wago.com/793-5501/000-006)**N° art.: 793-5501/000-007**

Carte de repérage WMB; en carte; extensible 5 - 5,2 MM; vierge; encliquetable

[www.wago.com/793-5501/000-007](http://www.wago.com/793-5501/000-007)**N° art.: 793-5501/000-012**

Carte de repérage WMB; en carte; extensible 5 - 5,2 MM; vierge; encliquetable

[www.wago.com/793-5501/000-012](http://www.wago.com/793-5501/000-012)**N° art.: 793-5501/000-017**

Carte de repérage WMB; en carte; extensible 5 - 5,2 MM; vierge; encliquetable

[www.wago.com/793-5501/000-017](http://www.wago.com/793-5501/000-017)**N° art.: 793-5501/000-023**

Carte de repérage WMB; en carte; extensible 5 - 5,2 MM; vierge; encliquetable

[www.wago.com/793-5501/000-023](http://www.wago.com/793-5501/000-023)**N° art.: 793-5501/000-024**

Carte de repérage WMB; en carte; extensible 5 - 5,2 MM; vierge; encliquetable

[www.wago.com/793-5501/000-024](http://www.wago.com/793-5501/000-024)



## Téléchargements

### Documentation

#### Bid Text

2004-1305	Aug 13, 2018	DOCX	Téléchargement
Reihenklennen, TOPJOB S		15,1 kB	

---

### smartDATA

#### CAD data

3D Download 2004-1305		URL	Téléchargement
-----------------------	--	-----	----------------

---

Sous réserve de modifications.