

Fiche technique | Numéro d'article: 2006-8671

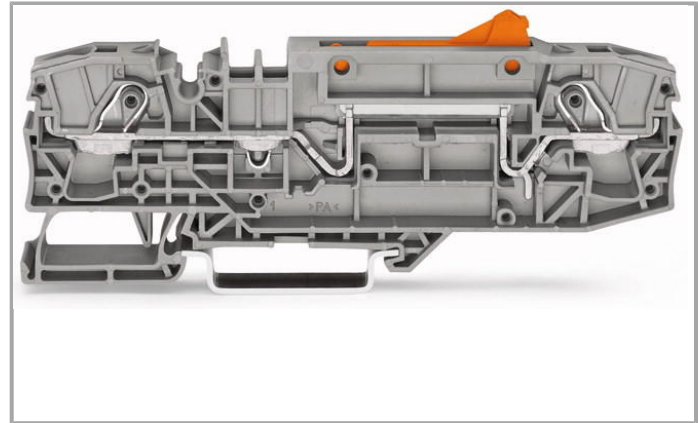

Borne sectionnable et de mesure pour 2 conducteurs; avec sectionneur pivotant; avec ouverture de test; Support du sectionneur, orange; Pour rail 35 x 15 et 35 x 7,5; 6 mm<sup>2</sup>; Push-in CAGE CLAMP®

[www.wago.com/2006-8671](http://www.wago.com/2006-8671)

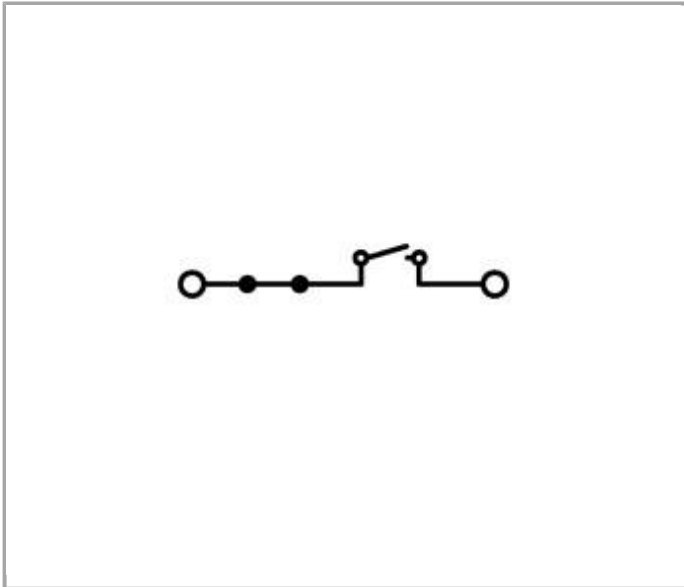
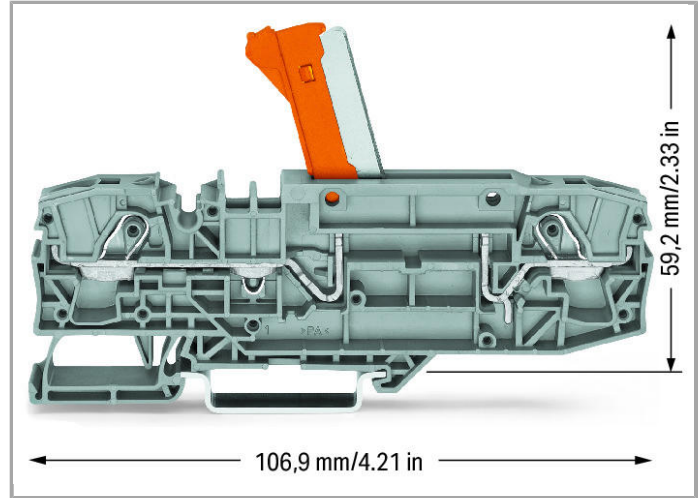
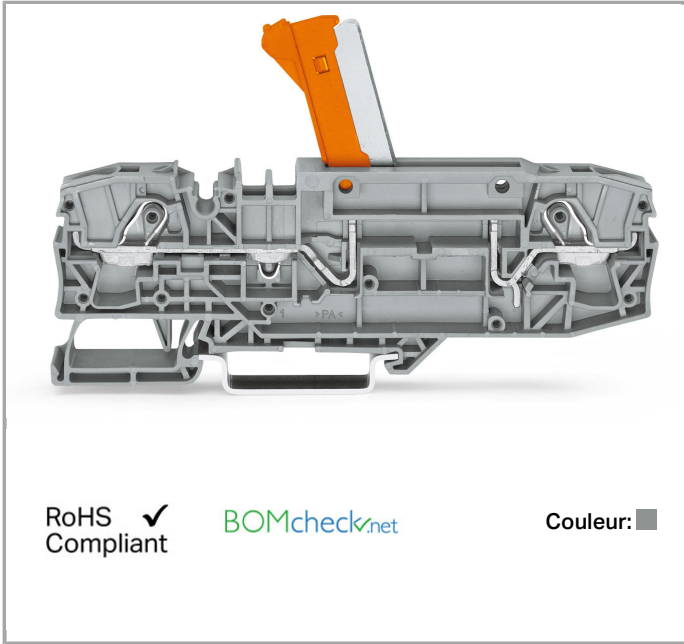

Données

Données électriques

Type de la tension 1

AC/DC

Ratings per IEC/EN 60664-1

Tension de référence (III / 3)

1000 V

Tension assignée de tenue aux chocs (III / 3)	12 kV
Courant	30 A
Tension de référence (III / 3) 2	1500 V
Tension assignée de tenue aux chocs (III / 3) 2	12 kV
Légende Données de référence	(III / 3) $\hat{=}$ Catégorie de surtension III / degré de pollution 3

### Approvals per UL 1059

Tension de référence UL (Use Group B)	600 V
Courant de référence UL (Use Group B)	30 A
Tension de référence UL (Use Group C)	600 V
Courant de référence UL (Use Group C)	30 A

### Approvals per CSA

Tension de référence CSA (Use Group B)	600 V
Courant de référence CSA (Use Group B)	30 A
Tension de référence CSA (Use Group C)	1000 V
Courant de référence CSA (Use Group C)	30 A

### Données de raccordement

Technique de connexion	Push-in CAGE CLAMP®
Type d'actionnement	Push-in Outil de manipulation
Matière plastique conducteur raccordable	Cuivre
Section nominale :	6 mm <sup>2</sup>
Conducteur rigide	0,5 ... 10 mm <sup>2</sup> / 20 ... 8 AWG
Conducteur rigide, enfichage direct	2,5 ... 10 mm <sup>2</sup> / 14 ... 8 AWG
Conducteur souple	0,5 ... 10 mm <sup>2</sup> / 20 ... 8 AWG
conducteur souple avec embout d'extrémité, directement enfichable à partir de	2,5 mm <sup>2</sup> / 16 AWG
Longueur de dénudage	13 ... 15 mm / 0.51 ... 0.59 inch
Nombre total des points de serrage	2
Nombre total des potentiels	1
nombre des niveaux	1
Type de câblage	câblage frontal

### Données géométriques

Largeur	15 mm / 0.591 inch
Profondeur à partir du niveau supérieur du rail	33 mm / 1.299 inch
Profondeur	106,9 mm / 4.209 inch

## Données mécaniques

Mode de construction	type horizontal
Type de montage	Rail 35
Niveau de marquage	Marquage central/latéral

## Données du matériau

Couleur	gris
Matière isolante	Polyamide 66 (PA 66)
Charge calorifique	0.673 MJ
Poids	31.425 g

## Dates commerciales

Country of origin	DE
GTIN	4050821372509
Customs Tariff No.	85365080990
Product Group	22 (TOPJOB S)

## Autorisations / certificats

### Approbations spécifiques au pays

Logo	Approbation	Nom du certificat
	<b>CCA</b> DEKRA Certification B.V.	NTR NL 7311
	<b>CCA</b> DEKRA Certification B.V.	71-101179

### Approbations de navire

Logo	Approbation	Nom du certificat
	<b>ABS</b> American Bureau of Shipping	14-HG1293677-PDA

### Approbations UL

Logo	Approbation	Nom du certificat
	<b>UL</b> Underwriters Laboratories Inc.	E45172

## Produits correspondants

## Protective Warning Marker

	<b>N° art.: 2006-115</b> Obturbateur de protection avec signalisation de danger; avec signalisation de danger; pour 5 bornes	<a href="http://www.wago.com/2006-115">www.wago.com/2006-115</a>
--	---	--

## check

	<b>N° art.: 2009-174</b> Adaptateur de test; pour fiche de test Ø 4 mm; pour tester les bornes sur rail TOPJOB®S	<a href="http://www.wago.com/2009-174">www.wago.com/2009-174</a>
---	---	--

	<b>N° art.: 2009-182</b> Prise de test; pour max. 2,5 mm <sup>2</sup> ; pour le raccordement sans outil des conducteurs de contrôle individuels de 0,08	<a href="http://www.wago.com/2009-182">www.wago.com/2009-182</a>
--	--	--

	<b>N° art.: 210-136</b> Fiche de contrôle; Ø 2 mm; avec câble de longueur 500 mm	<a href="http://www.wago.com/210-136">www.wago.com/210-136</a>
--	---	--

## Marking accessories

	<b>N° art.: 2009-110</b> Bandes de marquage; sur rouleau; non extensible; vierge; encliquetable	<a href="http://www.wago.com/2009-110">www.wago.com/2009-110</a>
--	--	--

	<b>N° art.: 2009-115</b> WMB-Inline; pour smartPRINTER; sur rouleau; extensible 5 - 5,2 MM; vierge; encliquetable	<a href="http://www.wago.com/2009-115">www.wago.com/2009-115</a>
--	--	--

	<b>N° art.: 2009-115/000-002</b> WMB-Inline; pour smartPRINTER; sur rouleau; extensible 5 - 5,2 MM; vierge; encliquetable	<a href="http://www.wago.com/2009-115/000-002">www.wago.com/2009-115/000-002</a>
--	--	--

	<b>N° art.: 2009-115/000-006</b> WMB-Inline; pour smartPRINTER; sur rouleau; extensible 5 - 5,2 MM; vierge; encliquetable	<a href="http://www.wago.com/2009-115/000-006">www.wago.com/2009-115/000-006</a>
--	--	--

	<b>N° art.: 2009-115/000-007</b> WMB-Inline; sur rouleau; extensible 5 - 5,2 MM; vierge; encliquetable	<a href="http://www.wago.com/2009-115/000-007">www.wago.com/2009-115/000-007</a>
--	---	--

















	<b>N° art.: 2009-115/000-012</b> WMB-Inline; pour smartPRINTER; sur rouleau; extensible 5 - 5,2 MM; vierge; encliquetable	<a href="http://www.wago.com/2009-115/000-012">www.wago.com/2009-115/000-012</a>
--	--	--















	<b>N° art.: 2009-115/000-017</b> WMB-Inline; sur rouleau; extensible 5 - 5,2 MM; vierge; encliquetable	<a href="http://www.wago.com/2009-115/000-017">www.wago.com/2009-115/000-017</a>
--	---	--

	<b>N° art.: 2009-115/000-023</b> WMB-Inline; pour smartPRINTER; sur rouleau; extensible 5 - 5,2 MM; vierge; encliquetable	<a href="http://www.wago.com/2009-115/000-023">www.wago.com/2009-115/000-023</a>
--	--	--

	<b>N° art.: 2009-115/000-024</b> WMB-Inline; pour smartPRINTER; sur rouleau; extensible 5 - 5,2 MM; vierge; encliquetable	<a href="http://www.wago.com/2009-115/000-024">www.wago.com/2009-115/000-024</a>
--	--	--

	<b>N° art.: 2009-145</b> Mini-WSB Inline; pour smartPRINTER; sur rouleau; extensible 5 - 5,2 MM; vierge; encliquetable	<a href="http://www.wago.com/2009-145">www.wago.com/2009-145</a>
--	---	--

	<p><b>N° art.: 2009-145/000-002</b> Mini-WSB Inline; sur rouleau; extensible 5 - 5,2 MM; vierge; encliquetable</p>	<a href="http://www.wago.com/2009-145/000-002">www.wago.com/2009-145/000-002</a>
	<p><b>N° art.: 2009-145/000-005</b> Mini-WSB Inline; vierge; 1700 étiquettes Mini-WSB (5 mm) sur rouleau; extensible 5 - 5,2 MM</p>	<a href="http://www.wago.com/2009-145/000-005">www.wago.com/2009-145/000-005</a>
	<p><b>N° art.: 2009-145/000-006</b> Mini-WSB Inline; pour smartPRINTER; sur rouleau; extensible 5 - 5,2 MM; vierge; encliquetable</p>	<a href="http://www.wago.com/2009-145/000-006">www.wago.com/2009-145/000-006</a>
	<p><b>N° art.: 2009-145/000-007</b> Mini-WSB Inline; vierge; 1700 étiquettes Mini-WSB (5 mm) sur rouleau; extensible 5 - 5,2 MM</p>	<a href="http://www.wago.com/2009-145/000-007">www.wago.com/2009-145/000-007</a>
	<p><b>N° art.: 2009-145/000-012</b> Mini-WSB Inline; pour smartPRINTER; sur rouleau; extensible 5 - 5,2 MM; vierge; encliquetable</p>	<a href="http://www.wago.com/2009-145/000-012">www.wago.com/2009-145/000-012</a>
	<p><b>N° art.: 2009-145/000-023</b> Mini-WSB Inline; sur rouleau; extensible 5 - 5,2 MM; vierge; encliquetable</p>	<a href="http://www.wago.com/2009-145/000-023">www.wago.com/2009-145/000-023</a>
	<p><b>N° art.: 2009-145/000-024</b> Mini-WSB Inline; sur rouleau; extensible 5 - 5,2 MM; vierge; encliquetable</p>	<a href="http://www.wago.com/2009-145/000-024">www.wago.com/2009-145/000-024</a>
	<p><b>N° art.: 2009-191</b> Porte-étiquettes de groupe</p>	<a href="http://www.wago.com/2009-191">www.wago.com/2009-191</a>
	<p><b>N° art.: 2009-192</b> Porte-étiquettes de groupe</p>	<a href="http://www.wago.com/2009-192">www.wago.com/2009-192</a>
	<p><b>N° art.: 2009-193</b> Porte-étiquettes de groupe</p>	<a href="http://www.wago.com/2009-193">www.wago.com/2009-193</a>
	<p><b>N° art.: 2009-198</b> Adaptateur</p>	<a href="http://www.wago.com/2009-198">www.wago.com/2009-198</a>
	<p><b>N° art.: 248-501</b> Système de repérage rapide Mini-WSB; vierge; Largeur d'étiquettes 5 mm; 10 bandes à 10 étiquettes par carte</p>	<a href="http://www.wago.com/248-501">www.wago.com/248-501</a>
	<p><b>N° art.: 248-501/000-002</b> Carte de repérage mini WSB; en carte; non extensible; vierge; encliquetable</p>	<a href="http://www.wago.com/248-501/000-002">www.wago.com/248-501/000-002</a>
	<p><b>N° art.: 248-501/000-005</b> Carte de repérage mini WSB; en carte; vierge; encliquetable</p>	<a href="http://www.wago.com/248-501/000-005">www.wago.com/248-501/000-005</a>
	<p><b>N° art.: 248-501/000-006</b> Carte de repérage mini WSB; en carte; non extensible; vierge; encliquetable</p>	<a href="http://www.wago.com/248-501/000-006">www.wago.com/248-501/000-006</a>
	<p><b>N° art.: 248-501/000-007</b> Carte de repérage mini WSB; en carte; non extensible; vierge; encliquetable</p>	<a href="http://www.wago.com/248-501/000-007">www.wago.com/248-501/000-007</a>

	<p><b>N° art.: 248-501/000-012</b>                      Carte de repérage mini WSB; en carte; non extensible; vierge; encliquetable</p>	<p><a href="http://www.wago.com/248-501/000-012">www.wago.com/248-501/000-012</a></p>
	<p><b>N° art.: 248-501/000-017</b>                      Carte de repérage mini WSB; en carte; non extensible; vierge; encliquetable</p>	<p><a href="http://www.wago.com/248-501/000-017">www.wago.com/248-501/000-017</a></p>
	<p><b>N° art.: 248-501/000-023</b>                      Carte de repérage mini WSB; en carte; non extensible; vierge; encliquetable</p>	<p><a href="http://www.wago.com/248-501/000-023">www.wago.com/248-501/000-023</a></p>
	<p><b>N° art.: 248-501/000-024</b>                      Carte de repérage mini WSB; en carte; non extensible; vierge; encliquetable</p>	<p><a href="http://www.wago.com/248-501/000-024">www.wago.com/248-501/000-024</a></p>
	<p><b>N° art.: 793-501</b>                      Carte de repérage WMB; en carte; non extensible; vierge; encliquetable</p>	<p><a href="http://www.wago.com/793-501">www.wago.com/793-501</a></p>
	<p><b>N° art.: 793-501/000-002</b>                      Carte de repérage WMB; en carte; non extensible; vierge; encliquetable</p>	<p><a href="http://www.wago.com/793-501/000-002">www.wago.com/793-501/000-002</a></p>
	<p><b>N° art.: 793-501/000-005</b>                      Carte de repérage WMB; en carte; non extensible; vierge; encliquetable</p>	<p><a href="http://www.wago.com/793-501/000-005">www.wago.com/793-501/000-005</a></p>
	<p><b>N° art.: 793-501/000-006</b>                      Carte de repérage WMB; en carte; non extensible; vierge; encliquetable</p>	<p><a href="http://www.wago.com/793-501/000-006">www.wago.com/793-501/000-006</a></p>
	<p><b>N° art.: 793-501/000-007</b>                      Carte de repérage WMB; en carte; non extensible; vierge; encliquetable</p>	<p><a href="http://www.wago.com/793-501/000-007">www.wago.com/793-501/000-007</a></p>
	<p><b>N° art.: 793-501/000-012</b>                      Carte de repérage WMB; en carte; non extensible; vierge; encliquetable</p>	<p><a href="http://www.wago.com/793-501/000-012">www.wago.com/793-501/000-012</a></p>
	<p><b>N° art.: 793-501/000-017</b>                      Carte de repérage WMB; en carte; non extensible; vierge; encliquetable</p>	<p><a href="http://www.wago.com/793-501/000-017">www.wago.com/793-501/000-017</a></p>
	<p><b>N° art.: 793-501/000-023</b>                      Carte de repérage WMB; en carte; non extensible; vierge; encliquetable</p>	<p><a href="http://www.wago.com/793-501/000-023">www.wago.com/793-501/000-023</a></p>
	<p><b>N° art.: 793-501/000-024</b>                      Carte de repérage WMB; en carte; non extensible; vierge; encliquetable</p>	<p><a href="http://www.wago.com/793-501/000-024">www.wago.com/793-501/000-024</a></p>
	<p><b>N° art.: 793-5501</b>                      Carte de repérage WMB; en carte; largeur des bornes 5 - 17,5 mm; extensible 5 - 5,2 MM; vierge; encliquetable</p>	<p><a href="http://www.wago.com/793-5501">www.wago.com/793-5501</a></p>
	<p><b>N° art.: 793-5501/000-002</b>                      Carte de repérage WMB; en carte; largeur des bornes 5 - 17,5 mm; extensible 5 - 5,2 MM; vierge; encliquetable</p>	<p><a href="http://www.wago.com/793-5501/000-002">www.wago.com/793-5501/000-002</a></p>



**N° art.: 793-5501/000-005**  
Carte de repérage WMB; en carte; extensible 5 - 5,2 MM; vierge; encliquetable

[www.wago.com/793-5501/000-005](http://www.wago.com/793-5501/000-005)



**N° art.: 793-5501/000-006**  
Carte de repérage WMB; en carte; extensible 5 - 5,2 MM; vierge; encliquetable

[www.wago.com/793-5501/000-006](http://www.wago.com/793-5501/000-006)



**N° art.: 793-5501/000-007**  
Carte de repérage WMB; en carte; extensible 5 - 5,2 MM; vierge; encliquetable

[www.wago.com/793-5501/000-007](http://www.wago.com/793-5501/000-007)



**N° art.: 793-5501/000-012**  
Carte de repérage WMB; en carte; extensible 5 - 5,2 MM; vierge; encliquetable

[www.wago.com/793-5501/000-012](http://www.wago.com/793-5501/000-012)



**N° art.: 793-5501/000-017**  
Carte de repérage WMB; en carte; extensible 5 - 5,2 MM; vierge; encliquetable

[www.wago.com/793-5501/000-017](http://www.wago.com/793-5501/000-017)



**N° art.: 793-5501/000-023**  
Carte de repérage WMB; en carte; extensible 5 - 5,2 MM; vierge; encliquetable

[www.wago.com/793-5501/000-023](http://www.wago.com/793-5501/000-023)



**N° art.: 793-5501/000-024**  
Carte de repérage WMB; en carte; extensible 5 - 5,2 MM; vierge; encliquetable

[www.wago.com/793-5501/000-024](http://www.wago.com/793-5501/000-024)

#### Carrier rail



**N° art.: 210-112**  
Rail acier; 35 x 7,5; épaisseur 1 mm; longueur 2 m; perforé; d'après EN 60715; Largeur de trou 25 mm; pas des trous 36 mm

[www.wago.com/210-112](http://www.wago.com/210-112)

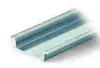

**N° art.: 210-113**  
Rail acier; 35 x 7,5; épaisseur 1 mm; longueur 2 m; non perforé; d'après EN 60715

[www.wago.com/210-113](http://www.wago.com/210-113)



**N° art.: 210-114**  
Rail acier; 35 x 15; épaisseur 1,5 mm; longueur 2 m; non perforé; d'après EN 60715

[www.wago.com/210-114](http://www.wago.com/210-114)



**N° art.: 210-115**  
Rail acier; 35 x 7,5; épaisseur 1 mm; longueur 2 m; perforé; d'après EN 60715; Largeur de trou 18 mm; pas des trous 25 mm

[www.wago.com/210-115](http://www.wago.com/210-115)



**N° art.: 210-118**  
Rail acier; 35 x 15; épaisseur 2,3 mm; longueur 2 m; non perforé; d'après EN 60715

[www.wago.com/210-118](http://www.wago.com/210-118)

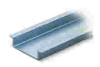

**N° art.: 210-196**  
Rail aluminium; 35 x 8,2; épaisseur 1,6 mm; longueur 2 m; non perforé; d'après EN 60715

[www.wago.com/210-196](http://www.wago.com/210-196)



**N° art.: 210-197**  
Rail acier; 35 x 15; épaisseur 1,5 mm; longueur 2 m; perforé; d'après EN 60715

[www.wago.com/210-197](http://www.wago.com/210-197)



**N° art.: 210-198**  
Rail en cuivre; 35 x 15; épaisseur 2,3 mm; longueur 2 m; non perforé; d'après EN 60715

[www.wago.com/210-198](http://www.wago.com/210-198)

#### General accessories



**N° art.: 2002-121**  
Adaptateur

[www.wago.com/2002-121](http://www.wago.com/2002-121)



N° art.: 2006-191  
Bouchon; Répartiteur de signaux

[www.wago.com/2006-191](http://www.wago.com/2006-191)

### Jumper



N° art.: 2006-433  
Peigne de pontage; isolé; de 1 à 3; Courant nominal 41 A

[www.wago.com/2006-433](http://www.wago.com/2006-433)



N° art.: 2006-435  
Peigne de pontage; isolé; de 1 à 5; Courant nominal 41 A

[www.wago.com/2006-435](http://www.wago.com/2006-435)



N° art.: 210-103  
Chaîne de pontage en fil; isolé; 50 raccords

[www.wago.com/210-103](http://www.wago.com/210-103)

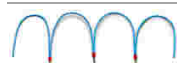

N° art.: 210-123  
Chaîne de pontage en fil; isolé; 50 raccords

[www.wago.com/210-123](http://www.wago.com/210-123)

### ferrule



N° art.: 216-208  
Embout d'extrémité; embout pour 6 mm<sup>2</sup> / AWG 10; avec isolation plastique; étamés par électrolyse; Cuivre électrolytique; serti de manière étanche aux gaz; selon DIN 46228, partie 4/09.90 [www.wago.com/216-208](http://www.wago.com/216-208)



N° art.: 216-262  
Embout d'extrémité; embout pour 0,75 mm<sup>2</sup> / AWG 20; avec isolation plastique; étamés par électrolyse; Cuivre électrolytique; serti de manière étanche aux gaz; selon DIN 46228, partie 4/09.90 [www.wago.com/216-262](http://www.wago.com/216-262)



N° art.: 216-263  
Embout d'extrémité; embout pour 1 mm<sup>2</sup> / AWG 18; avec isolation plastique; étamés par électrolyse; Cuivre électrolytique; serti de manière étanche aux gaz; selon DIN 46228, partie 4/09.90 [www.wago.com/216-263](http://www.wago.com/216-263)



N° art.: 216-264  
Embout d'extrémité; embout pour 1,5 mm<sup>2</sup> / AWG 16; avec isolation plastique; étamés par électrolyse; Cuivre électrolytique; serti de manière étanche aux gaz; selon DIN 46228, partie 4/09.90 [www.wago.com/216-264](http://www.wago.com/216-264)



N° art.: 216-266  
Embout d'extrémité; embout pour 2,5 mm<sup>2</sup> / AWG 14; avec isolation plastique; étamés par électrolyse; Cuivre électrolytique; serti de manière étanche aux gaz; selon DIN 46228, partie 4/09.90 [www.wago.com/216-266](http://www.wago.com/216-266)



N° art.: 216-267  
Embout d'extrémité; embout pour 4 mm<sup>2</sup> / AWG 12; avec isolation plastique; étamés par électrolyse; Cuivre électrolytique; serti de manière étanche aux gaz; selon DIN 46228, partie 4/09.90 [www.wago.com/216-267](http://www.wago.com/216-267)

### tools



N° art.: 210-721  
Outil de manipulation, partiellement isolé; Type 3, lame (5,5 x 0,8) mm

[www.wago.com/210-721](http://www.wago.com/210-721)

### End plate



N° art.: 2006-8691  
Plaque d'extrémité et intermédiaire; épaisseur 1 mm

[www.wago.com/2006-8691](http://www.wago.com/2006-8691)



N° art.: 2006-8692  
Plaque d'extrémité et intermédiaire; épaisseur 1 mm

[www.wago.com/2006-8692](http://www.wago.com/2006-8692)





## Téléchargements

### Documentation

#### Bid Text

---

2006-8671	Aug 13, 2018	DOCX 15,8 kB	Téléchargement
-----------	--------------	-----------------	----------------

---

### smartDATA

#### CAD data

---

3D Download 2006-8671		URL	Téléchargement
-----------------------	--	-----	----------------

---

Sous réserve de modifications.