

- **PLANETARY GEAR option:**
See special section in catalogue.
- **REDUCTOR PLANETARIO opcional:**
Ver sección especial en catálogo.
- **RÉDUCTEUR PLANÉTAIRE en option:**
Consultez section spécial du catalogue.
- **Optionales PLANETENGETRIEBE:**
Sehen Sie Sonderabschnitt im Katalog.

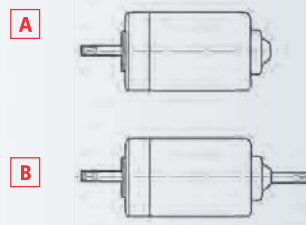

MOTOR FEATURES

REFERENCE NUMBER REFERENCIA REFERENCE REFERENZNUMMERN	NOMINAL VOLTAGE TENSION NOMINAL TENSION NOMINALE NENNSPANNUNG	NOMINAL TORQUE PAR NOMINAL COUPLE NOMINAL DREHMOMENT NOMINAL	NOMINAL SPEED VELOCIDAD NOMINAL VITESSE NOMINALE GESCHWINDIGKEIT NOMINAL	NOMINAL CURRENT CORRIENTE NOMINAL COURANT NOMINAL NOMINALSTROM	STARTING TORQUE PAR DE ARRANQUE COUPLE DE DÉMARRAGE ANZUGSDREHMOMENT	STARTING CURRENT CORRIENTE DE ARRANQUE COURANT DE DÉMARRAGE ANLAUFSTROM	SHAFT EJE ARBRE WELLE	CONNECTIONS CONEXIONES CONNEXIONS ANSCHLUSSART	WIRING DIAGRAM ESQUEMA ELECTRICO SCHEMA ELECTRIQUE SCHALTBILD	APPROXIMATE WEIGHT PESO APROXIMADO POIDS APPROXIMATIF GEWICHT (ca.)	WATERTIGHTNESS GRADO DE ESTANQUEIDAD ÉTANCHEITE FEUCHTIGKEITSSCHUTZKLASSE	DESIGN-A/B DISEÑO-A/B DISSIN-A/B ABBILDUNG-A/B	CURVE CURVA COURBE KURVE
	Un (V)	Mn (N.m./lbf.in)	Fn (r.p.m.)	In (A)	Ma (N.m./lbf.in)	Ia (A)				P (kg/lb)	IP		
16241012000	12	0.18 / 1.59	2800	7.5	1.0 / 8.85	33	E2	C2	EE2	1.1 / 2.43	IP53	A	32
16241013000	24	0.20 / 1.77	3000	4	1.0 / 8.85	18	E2	C2	EE2	1.1 / 2.43	IP53	A	33
16241022000	12	0.20 / 1.77	2000	6	1.0 / 8.85	24	E2	C3	EE2	1.1 / 2.43	IP53	A	34
16241023000	24	0.20 / 1.77	2000	3	1.0 / 8.85	12	E2	C3	EE2	1.1 / 2.43	IP53	A	34
16241062000	12	0.18 / 1.59	2800	7.5	1.0 / 8.85	33	E4	C2	EE2	1.1 / 2.43	IP53	A	32
16241063000	24	0.20 / 1.77	3000	4	1.0 / 8.85	18	E4	C2	EE2	1.1 / 2.43	IP53	A	33
16241073000E	24	0.20 / 1.77	2000	3	1.0 / 8.85	12	E5	C5	F3	1.1 / 2.43	IP53	A	34
16241082000	12	0.18 / 1.59	1500	5	0.8 / 7.08	17	E2	C3	EE2	1.1 / 2.43	IP53	A	35
16241083000	24	0.18 / 1.59	1500	2.5	0.8 / 7.08	8.5	E2	C3	EE2	1.1 / 2.43	IP53	A	35
16241093000	24	0.18 / 1.59	1500	2.5	0.8 / 7.08	8.5	E38	C35	EE3	1.1 / 2.43	IP53	A	35
16241095000	48	0.18 / 1.59	1500	1,3	0.8 / 7.08	4,5	E38	C35	EE3	1.1 / 2.43	IP53	A	35
16241163000	24	0.20 / 1.77	3000	4	1.0 / 8.85	18	E58/E57	C2	EE2	1.1 / 2.43	IP40	B	33

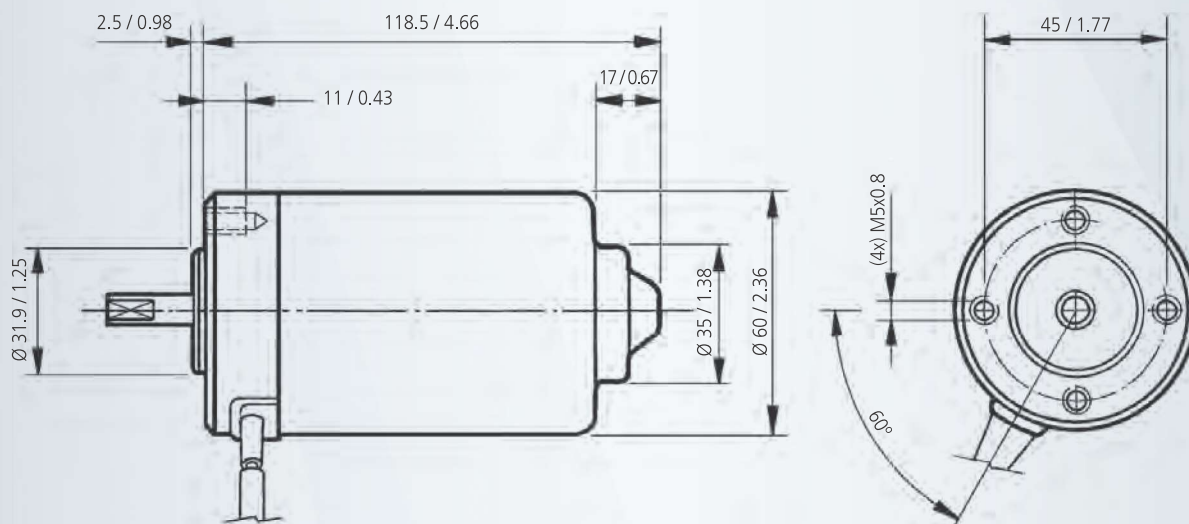

mm / inch

SHAFT EJE ARBRE WELLE

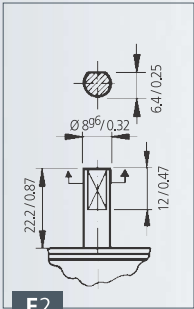

E2

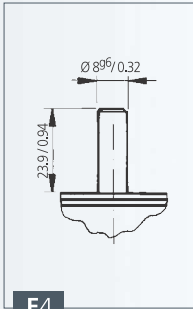

E4

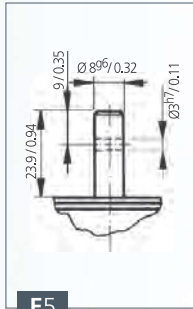

E5

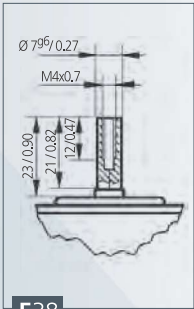

E38

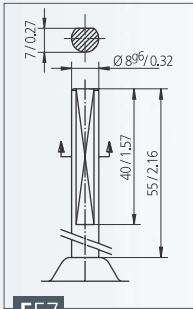

E57

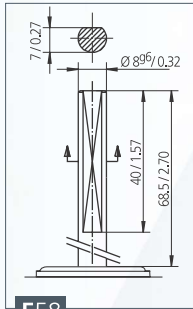

E58

CONNECTIONS CONEXIONES
CONNEXIONS ANSCHLUSSART

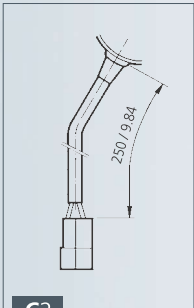

C2

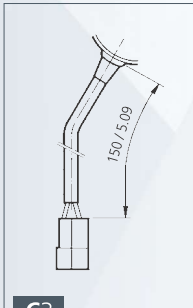

C3

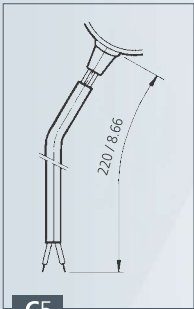

C5

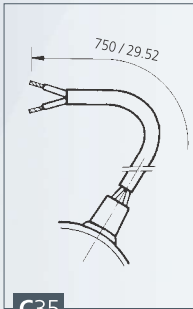

C35

WIRING DIAGRAM ESQUEMA ELÉCTRICO
SCHEMA ÉLECTRIQUE SCHALTBILD

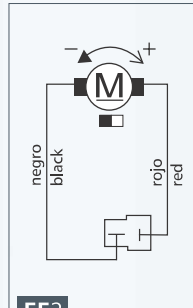

EE2

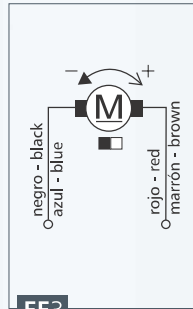

EE3

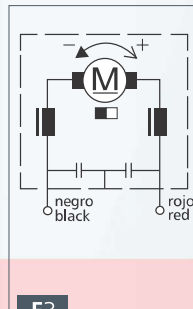

F3

CURVES CURVAS COURBES KURVEN

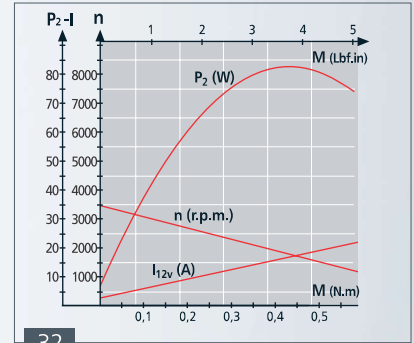

32

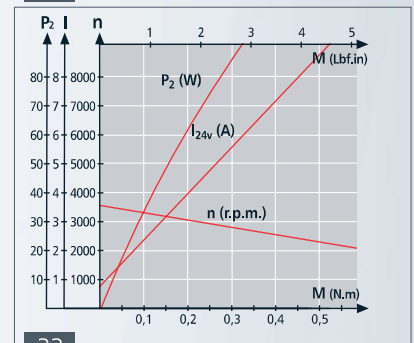

33

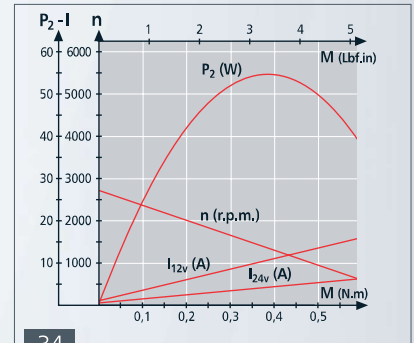

34

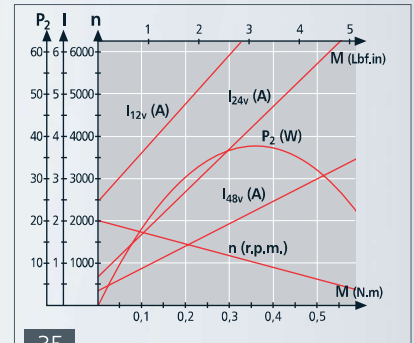

35