

MOTOR FEATURES

REFERENCE NUMBER REFERENCIA REFERENZNUMMERN	NOMINAL VOLTAGE TENSION NOMINALE NENNSPANNUNG	NOMINAL TORQUE PAR NOMINAL DREHMOMENT NOMINAL	NOMINAL SPEED VELOCIDAD NOMINAL GESCHWINDIGKEIT NOMINAL	NOMINAL CURRENT CORRIENTE NOMINAL COURANT NOMINAL NOMINALSTROM	STARTING TORQUE PAR DE ARRANQUE COUPLE DE DEMARRAGE ANZUGSDREHMOMENT	STARTING CURRENT CORRIENTE DE ARRANQUE COUPLET DE DEMARRAGE ANZUGSTROM	SHAFT EJE ARBRE WELLE	CONNECTIONS CONEXIONES CONNECTIONS ANSCHLUSSART	WIRING DIAGRAM ESQUEMA ELECTRICO SCHEMA ELECTRIQUE SCHALTPLAN	TRANSMISSION RATIO RELACION DE REDUCCION RAPPORT DE REDUCTEUR UNTERSATZUNG	APPROXIMATE WEIGHT PESO APROXIMADO POIDS APPROXIMATIF GEWICHT (ca.)	WATER TIGHTNESS GRADO DE ESTANQUEIDAD ETANCHÉITÉ FEUCHTIGKEITSSCHUTZKLASSE	WHEEL MATERIAL MATERIAL RUEDA MATERIAU ROUE MATERIAL DES SCHNITTENRADES	DESIGN: A, B, C DISEÑO: A, B, C Dessin: A, B, C ABBILDUNG: A, B, C	CURVE CURVA COURBE KURVE
	Un (V)	Mn (N.m./lbf.in)	Pn (r.p.m.)	In (A)	Ma (N.m./lbf.in)	Ia (A)				i	P (kg/lb)	IP			
11137112000	12	5 / 44.2	40	5	25 / 221.2	25	E22	C25	EE2	62:1	1.25 / 2.76	IP53	PLA	A	1
11137113000	24	5 / 44.2	40	2.5	25 / 221.2	13	E22	C25	EE2	62:1	1.25 / 2.76	IP53	PLA	A	1
11137612000	12	5 / 44.2	40	5	25 / 221.2	25	E23	C25	EE2	62:1	1.25 / 2.76	IP53	PLA	A	1
11137613000	24	5 / 44.2	40	2.5	25 / 221.2	13	E23	C25	EE2	62:1	1.25 / 2.76	IP53	PLA	A	1
11137612000E	12	5 / 44.2	40	5	25 / 221.2	25	E23	C25	F2	62:1	1.25 / 2.76	IP53	PLA	A	1
11137613000E	24	5 / 44.2	40	2.5	25 / 221.2	13	E23	C25	F2	62:1	1.25 / 2.76	IP53	PLA	A	1
11137632000	12	6 / 53.1	25	4	25 / 221.2	15	E23	C25	EE2	62:1	1.25 / 2.76	IP53	PLA	A	3
11137633000	24	6 / 53.1	25	2	25 / 221.2	8	E23	C25	EE2	62:1	1.25 / 2.76	IP53	PLA	A	3
11147613000	24	5 / 44.2	40	2.5	25 / 221.2	13	E23	C25	EE2	62:1	1.25 / 2.76	IP53	PLA	B	1
11190312000	12	3 / 26.5	70	6	25 / 221.2	34	E23	C25	EE2	62:1	1.25 / 2.76	IP53	PLA	A	2
11190313000	24	3 / 26.5	70	3	25 / 221.2	17	E23	C25	EE2	62:1	1.25 / 2.76	IP53	PLA	A	2
11190392000	12	1.5 / 13.2	240	8	10 / 88.5	46	E23	C26	EE1	49:4	1.25 / 2.76	IP53	PLA	A	4
11190393000	24	1.5 / 13.2	240	4	10 / 88.5	23	E23	C26	EE1	49:4	1.25 / 2.76	IP53	PLA	A	4
11190413000	24	5 / 44.2	40	2.5	25 / 221.2	13	E24	C25	EE2	62:1	1.30 / 2.87	IP53	BRO	A	1
11190942000	12	5 / 44.2	40	5	25 / 221.2	25	E52	C2	EE2	62:1	1.25 / 2.76	IP53	PLA	A	1
11191073000	24	1.5 / 13.2	240	4	14 / 123.9	23	E24/E53	C26	EE1	49:4	1.25 / 2.76	IP40	CEL	C	4
11191992000	12	3 / 26.5	100	6	20 / 177.01	48	E67	C26	F3	59:2	1.25 / 2.76	IP53	PLA	A	59
11191993000	24	3 / 26.5	100	3	20 / 177.01	24	E67	C26	F3	59:2	1.25 / 2.76	IP53	PLA	A	59

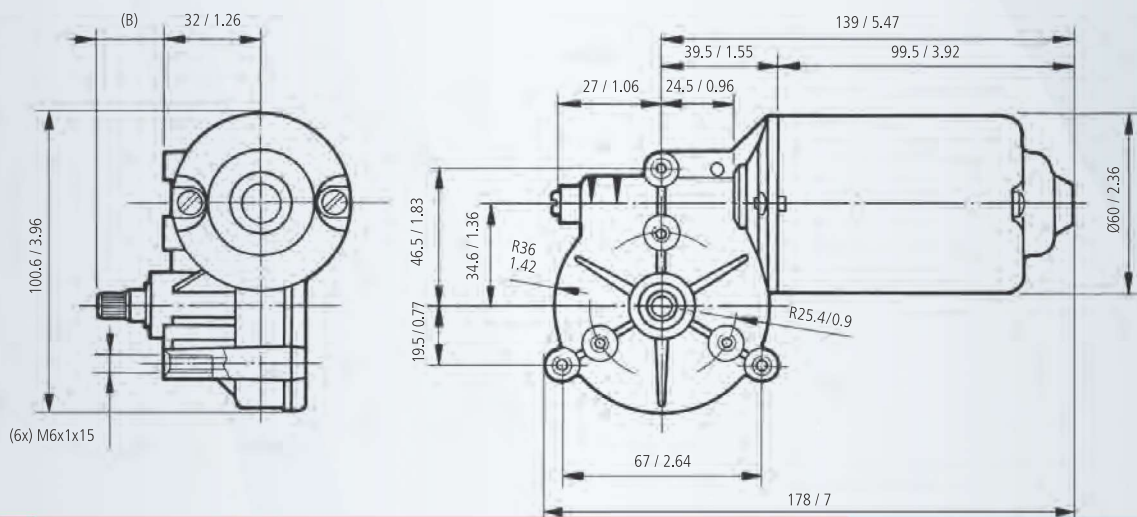

mm / inch

SHAFT EJE ARBRE WELLE

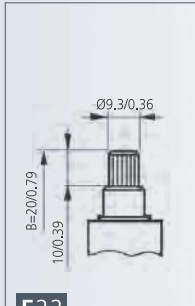

E22

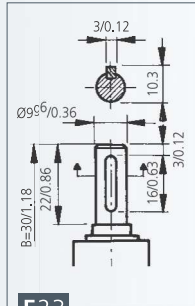

E23

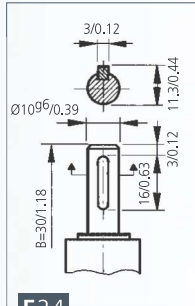

E24

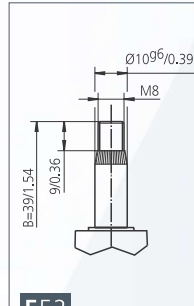

E52

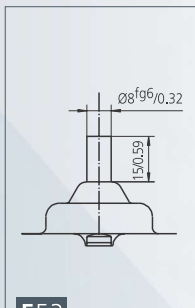

E53

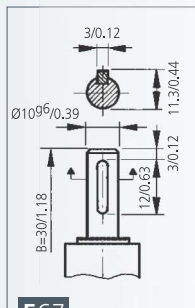

E67

CONNECTIONS CONEXIONES CONNEXIONS ANSCHLUSSART

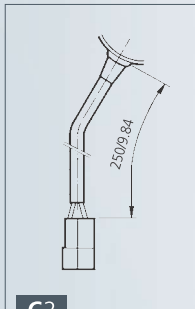

C2

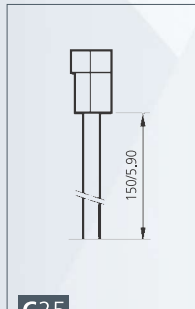

C25

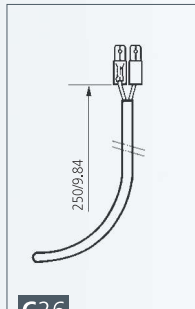

C26

WIRING DIAGRAM ESQUEMA ELÉCTRICO SCHEMA ÉLECTRIQUE SCHALTBILD

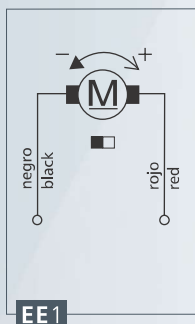

EE1

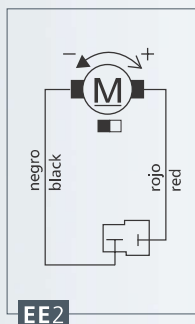

EE2

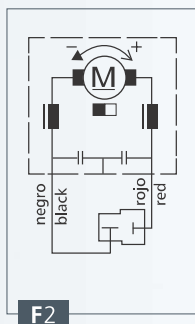

F2

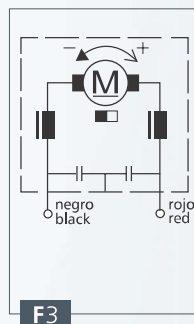

F3

CURVES CURVAS COURBES KURVEN

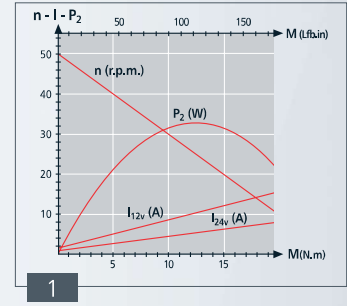

1

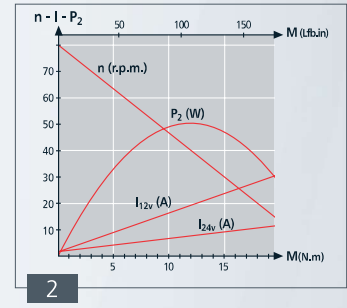

2

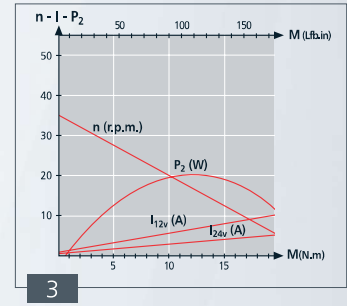

3

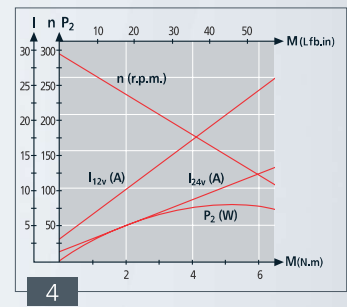

4

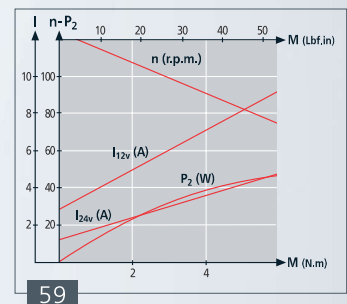

59