

- **PLANETARY GEAR option:**  
See special section in catalogue.
- **REDUCTOR PLANETARIO opcional:**  
Ver sección especial en catálogo.
- **RÉDUCTEUR PLANÉTAIRE en option:**  
Consultez section spécial du catalogue.
- **Optionales PLANETENGETRIEBE:**  
Sehen Sie Sonderabschnitt im Katalog.

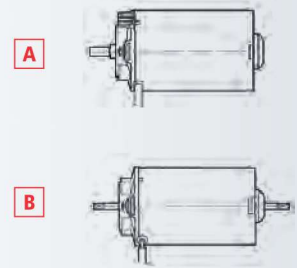

## MOTOR FEATURES

REFERENCE NUMBER REFERENCIA REFERENZNUMMERN	NOMINAL VOLTAGE TENSION NOMINAL TENSION NOMINALE NENNSPANNUNG	NOMINAL TORQUE PAR NOMINAL COUPLE NOMINAL DREHMOMENT NOMINAL	NOMINAL SPEED VELOCIDAD NOMINAL VITESSE NOMINALE GESCHWINDIGKEIT NOMINAL	NOMINAL CURRENT CORRIENTE NOMINAL COURANT NOMINAL NOMINALSTROM	STARTING TORQUE PAR DE ARRANQUE COUPLE DE DÉMARRAGE ANZUGSDREHMOMENT	STARTING CURRENT CORRIENTE DE ARRANQUE COURANT DE DÉMARRAGE ANLAUFSTROM	SHAFT EJE ARBRE WELLE	CONNECTIONS CONEXIONES CONNEXIONS ANSCHLUSSART	WIRING DIAGRAM ESQUEMA ELÉCTRICO SCHEMA ÉLECTRIQUE SCHALTBILD	APPROXIMATE WEIGHT PESO APROXIMADO POIDS APPROXIMATIF GEWICHT (ca.)	WATER TIGHTNESS GRADO DE ESTANQUEIDAD ÉTANCHÉITÉ FLUCHTIGKEITSSCHUTZKASSE	DESIGN: A-B DISEÑO: A-B DESSIN: A-B ABBILDUNG: A-B	CURVE CURVA COURBE KURVE
	Un (V)	Mn (N.m./lbf.in)	Pn (r.p.m.)	In (A)	Ma (N.m./lbf.in)	Ia (A)				P (kg/lb)	IP		
26941022004	12	0.50 / 4.42	3000	20	4 / 35.4	140	E20	C22	EE2	3.8 / 8.38	IP53	A	52
26941023004	24	0.75 / 6.63	3000	15	4 / 35.4	120	E20	C22	EE2	3.8 / 8.38	IP53	A	53
26941032004	12	0.50 / 4.42	3000	20	4 / 35.4	140	E21	C23	EE2	3.8 / 8.38	IP53	A	52
26941033004	24	0.75 / 6.63	3000	15	4 / 35.4	120	E21	C23	EE2	3.8 / 8.38	IP53	A	53
26941042004	12	0.80 / 7.08	1800	20	4 / 35.4	100	E48	C24	EE2	3.8 / 8.38	IP53	A	54
26941043004	24	0.80 / 7.08	1800	10	4 / 35.4	50	E48	C24	EE2	3.8 / 8.38	IP53	A	54
26941062004	12	0.80 / 7.08	1800	20	4 / 35.4	100	E21	C23	EE2	3.8 / 8.38	IP53	A	54
26941063004	24	0.80 / 7.08	1800	10	4 / 35.4	50	E21	C23	EE2	3.8 / 8.38	IP53	A	54
26941073004E	24	0.75 / 6.63	3000	15	4 / 35.4	120	E48/E11	C22	F2	3.8 / 8.38	IP40	B	53
26941082004E	12	0.80 / 7.08	1800	20	4 / 35.4	100	E48/E11	C24	F2	3.8 / 8.38	IP40	B	54
26941133004	24	0.50 / 4.42	675	2.25	2.7 / 23.8	12	E48	C24	EE2	3.8 / 8.38	IP53	A	55

Flange according to IEC 63 B14 - Puntos de anclaje según IEC 63 B14

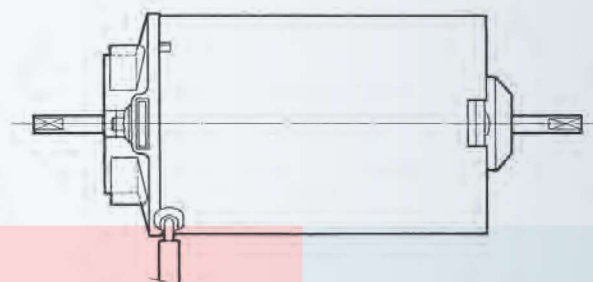
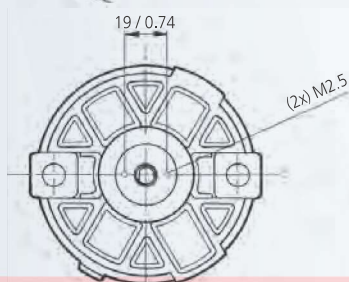
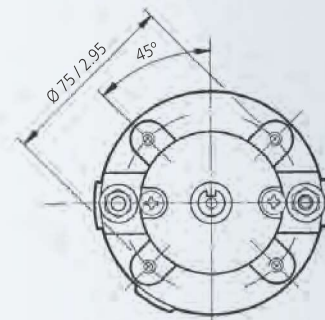
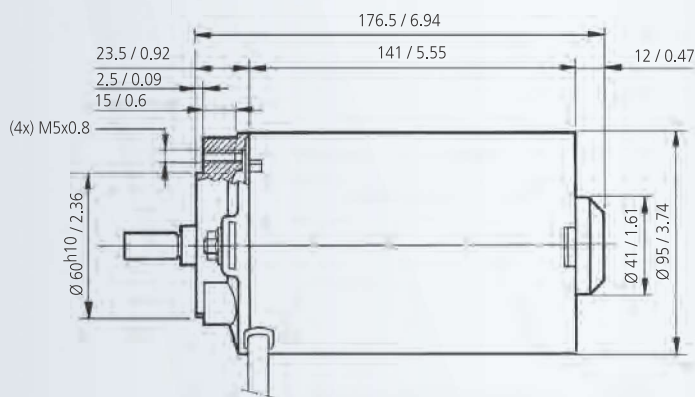

mm / inch

SHAFT EJE ARBRE WELLE

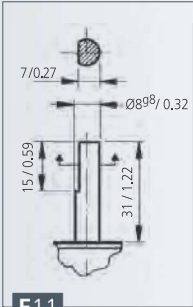

E11

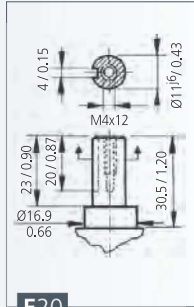

E20

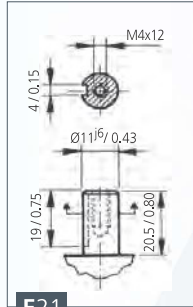

E21

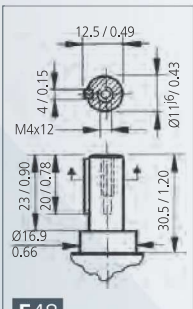

E48

CONNECTIONS CONEXIONES CONNEXIONS ANSCHLUSSART

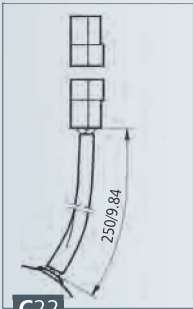

C22

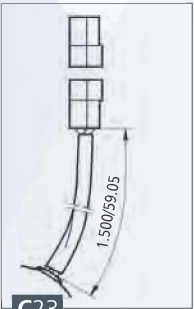

C23

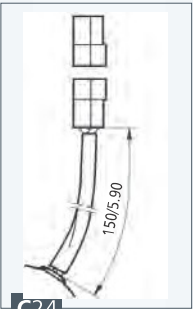

C24

WIRING DIAGRAM ESQUEMA ELÉCTRICO SCHÉMA ÉLECTRIQUE SCHALTBIKD

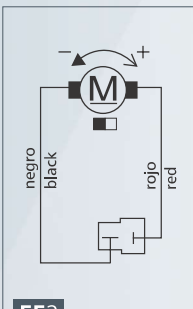

EE2

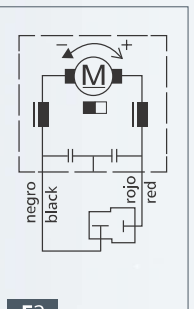

F2

CURVES CURVAS COURBES KURVEN

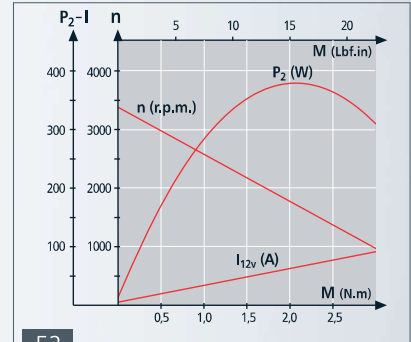

52

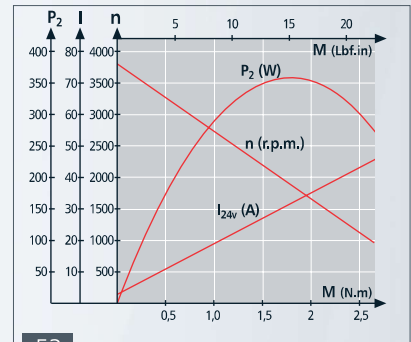

53

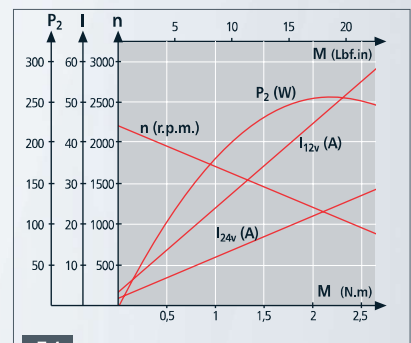

54

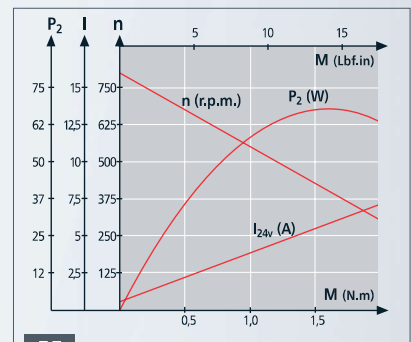

55