

319

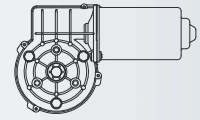

A



B

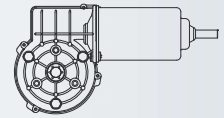

MOTOR FEATURES

REFERENCE NUMBER REFERENCIA REFERENZNUMMERN	NOMINAL VOLTAGE TENSION NOMINALE NENNSPANNUNG	NOMINAL TORQUE PAR NOMINAL DREHMOMENT NOMINAL	NOMINAL SPEED VELOCIDAD NOMINAL VITESSE NOMINALE GESCHWINDIGKEIT NOMINAL	NOMINAL CURRENT CORRENTE NOMINAL COURANT NOMINAL NOMINALSTROM	STARTING TORQUE PAR DE ARRANQUE COUPLE DE DEMARRAGE ANZUGSDREHMOMENT	STARTING CURRENT CORRENTE DE ARRANQUE COURANT DE DEMARRAGE ANLAUFSTROM	SHAFT EJE ARBRE WELLE	CONNECTIONS CONEXIONES CONNEXIONS ANSCHLUSSART	WIRING DIAGRAM ESQUEMA ELECTRICO SCHEMA ELECTRIQUE SCHALDPLAN	TRANSMISSION RATIO RELACION DE REDUCCION RAPPORT DE REDUCTEUR UNTERSATZUNG	APPROXIMATE WEIGHT PESO APROXIMADO POIDS APPROXIMATIF GEWICHT (ca.)	WATERTIGHTNESS GRADO DE ESTANQUEIDAD ETANCHÉITÉ FEUCHTIGKEITSSCHUTZKLASSE	WHEEL MATERIAL MATERIAL RUEDA MATERIAU ROUE MATERIAL DES SCHNECKENRADES	DESIGN-A,B,C DISEÑO-A,B,C DRESSIN-A,B,C ABBILDUNG-A,B,C	CURVE CURVA COURBE KURVE
	Un (V)	Mn (N.m./lbf.in)	nn (r.p.m.)	In (A)	Ma (N.m./lbf.in)	Ia (A)			i	P (kg/lb)	IP				
31918462000	12	4 / 35	85	7	40 / 354	60	E35	C37	F5	78:2	1.7 / 3.75	IP65	PLA	A	62
31918463000	24	4 / 35	85	3.5	40 / 354	30	E35	C37	F5	78:2	1.7 / 3.75	IP65	PLA	A	62
31918602000	12	9 / 79.6	30	7	50 / 442	28	E35	C37	F5	81:1	1.7 / 3.75	IP65	PLA	A	58
31918603000	24	9 / 79.6	30	3	50 / 442	15	E35	C37	F5	81:1	1.7 / 3.75	IP65	PLA	A	58
31918622000	12	8 / 70.8	45	6	50 / 442	50	E35	C37	F5	81:1	1.7 / 3.75	IP65	PLA	A	60
31918623000	24	9 / 79.6	45	3	60 / 531	25	E35	C37	F5	81:1	1.7 / 3.75	IP65	PLA	A	61
31938202000	12	9 / 79.6	30	7	50 / 442	28	E35	C37	EE4	81:1	1.7 / 3.75	IP65	BRO	A	58
31938203000	24	9 / 79.6	30	3	50 / 442	15	E35	C37	EE4	81:1	1.7 / 3.75	IP65	BRO	A	58
31938222000	12	8 / 70.8	45	6	50 / 442	50	E35	C37	EE4	81:1	1.7 / 3.75	IP65	BRO	A	60
31938223000	24	9 / 79.6	45	3	60 / 531	25	E35	C37	EE4	81:1	1.7 / 3.75	IP65	BRO	A	61
31938452000	12	6 / 53.1	65	8	35 / 309	40	E35	C37	EE4	78:2	1.7 / 3.75	IP65	PLA	A	67
31938453000	24	6 / 53.1	65	4	40 / 354	25	E35	C37	EE4	78:2	1.7 / 3.75	IP65	PLA	A	67
31938462000	12	4 / 35	85	7	40 / 354	60	E35	C37	EE4	78:2	1.7 / 3.75	IP65	PLA	A	62
31938463000	24	4 / 35	85	3.5	40 / 354	30	E35	C37	EE4	78:2	1.7 / 3.75	IP65	PLA	A	62
31938602000	12	9 / 79.6	30	7	50 / 442	28	E35	C37	EE4	81:1	1.7 / 3.75	IP65	PLA	A	58
31938603000	24	9 / 79.6	30	3	50 / 442	15	E35	C37	EE4	81:1	1.7 / 3.75	IP65	PLA	A	58
31938622000	12	8 / 70.8	45	6	50 / 442	50	E35	C37	EE4	81:1	1.7 / 3.75	IP65	PLA	A	60
31938623000	24	9 / 79.6	45	3	60 / 531	25	E35	C37	EE4	81:1	1.7 / 3.75	IP65	PLA	A	61
31990593000	24	2.2 / 19.47	230	4	20 / 177	36	E35	C37	EE4	68:4	1.7 / 3.75	IP65	PLA	A	65
31991283000	24	2.2 / 19.47	230	4	20 / 177	36	E35/E66	C38	EE4	68:4	1.7 / 3.75	IP40	PLA	B	65
31991372000	12	2 / 17.7	155	8	20 / 177	60	E35	C38	EE4	68:4	1.7 / 3.75	IP65	PLA	A	66
31991373000	24	2 / 17.7	175	4	20 / 177	30	E35	C38	EE4	68:4	1.7 / 3.75	IP65	PLA	A	66

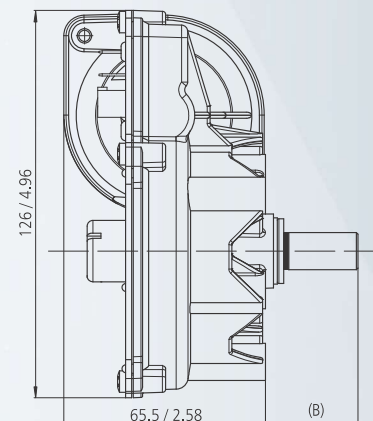
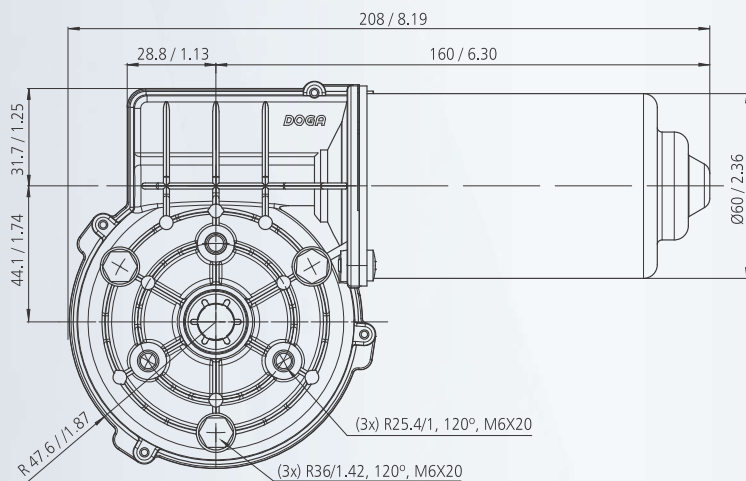

mm / inch

SHAFT EJE ARBRE WELLE

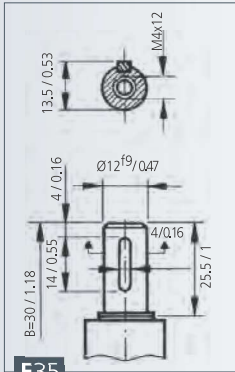

E35

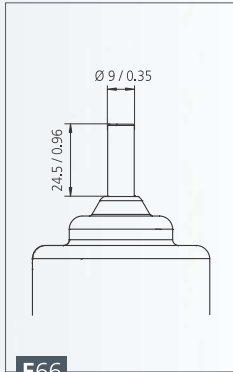

E66

CONEXIONES **CONNECTIONS**
CONNEXIONS ANSCHLUSSART

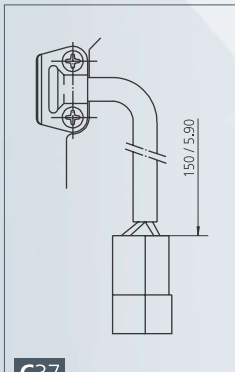

C37

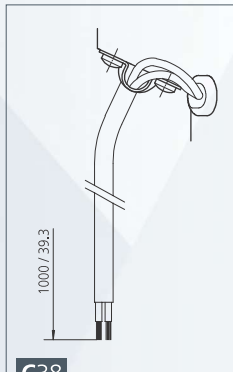

C38

WIRING DIAGRAM **ESQUEMA ELÉCTRICO**
SCHEMA ÉLECTRIQUE SCHALTBILD

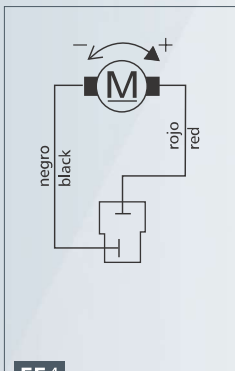

EE4

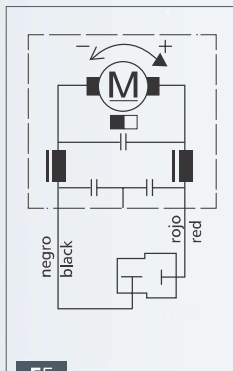

F5

CURVAS **CURVES** COURBES KURVEN

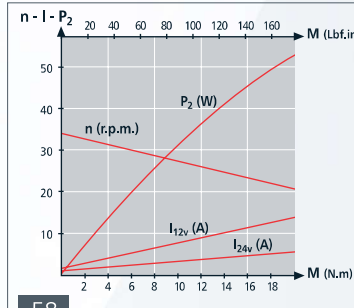

58

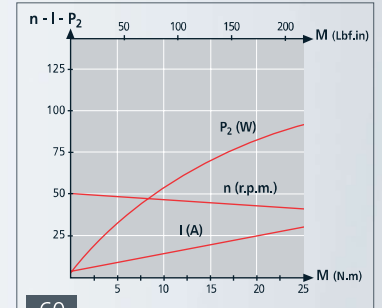

60

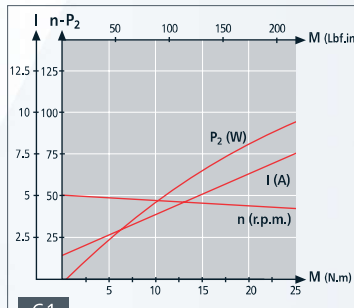

61

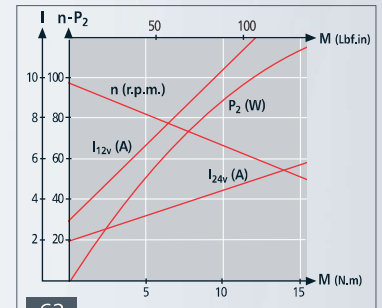

62

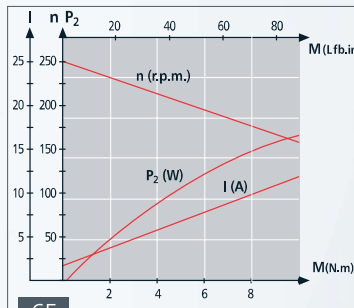

65

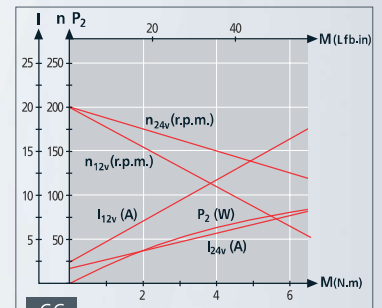

66

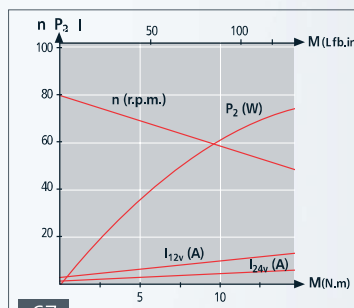

67