

83

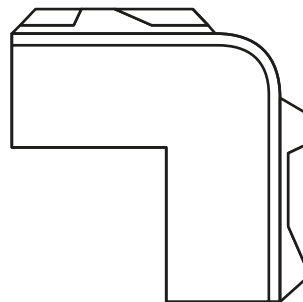

56



22