

1	EN	Instruction Manual	DC Power Supply
2	DE	Bedienungsanleitung	DC Stromversorgung
3	FR	Manual d'instructions	DC Alimentation d'Énergie
4	ES	Manual de instrucciones	DC Fuente De Alimentación
5	IT	Manuale di Istruzione	DC Gruppo di alimentazione
6	PT	Manual de Instruções	DC Fonte De Alimentação

PULS

MiniLine

ML90 / ML95 / ML100

Read first !

English **1**

Before operating this unit please read this manual thoroughly. Retain this manual for future reference! The power supply may only be installed and put into operation by qualified personnel.

Intended Use:

This device is designed for installation in an enclosure and is intended for the general use such as in industrial control, communication, and instrumentation equipment. Do not use this device in aircraft, trains and nuclear equipment where malfunction of the power supply may cause severe personal injury or threaten human life.

<p>⚠ WARNING !</p> <p>Risk of electrical shock, fire, personal injury or death.</p> <p>(1) Do not use the unit without proper grounding (Protective earth)</p> <p>(2) Turn power off before working on the power supply. Protect against inadvertent reworking.</p> <p>(3) Make sure that the wiring is correct by following all local and national codes.</p> <p>(4) Do not modify or repair the unit.</p> <p>(5) Do not open the unit as high voltages are present inside.</p> <p>(6) Use caution to prevent any foreign objects from entering into the housing.</p> <p>(7) Do not expose the unit to wet locations.</p> <p>(8) Do not use the unit in area where moisture or condensation can be expected</p>	<p>⚠ CAUTION !</p> <p>Reduction of output power may be necessary when:</p> <p>(1) Minimum installation clearance can not be met</p> <p>(2) Altitudes higher than 2000m</p> <p>(3) Power supply is used above 60°C ambient</p> <p>(4) Mounting orientation is other than input terminal located at the bottom and output at the top.</p> <p>(5) Airflow for convection cooling is obstructed</p> <p>Details for de-rating can be found in this manual.</p> <p>Do not touch during power-on, and immediately after power-off. Hot surface may cause heat injury. The unit does not contain serviceable parts. The tripping of an internal fuse is caused by an internal defect. If damage or malfunction should occur during operation, immediately turn power off and send unit for inspection to the factory!</p>
---	--

The information presented in this document is believed to be accurate and reliable and may change without notice. The English text applies in cases of doubt.

Notes for use in hazardous locations	<p>WARNING EXPLOSION HAZARDS</p> <p>Units which are marked with "Class I Div 2" are suitable for use in non-hazardous or Class I Division 2 Groups A, B, C, D locations only.</p> <p>Substitution of components may impair suitability for Class I Division 2 environment. Do not disconnect equipment unless power has been switched off.</p> <p>Wiring must be in accordance with Class I, Division 2 wiring methods of the National Electrical Code, NFPA 70, and in accordance with other local or national codes.</p>
---	---

Vor Inbetriebnahme lesen !

Deutsch **2**

Bitte lesen Sie diese Warnungen und Hinweise sorgfältig durch bevor Sie die Stromversorgung in Betrieb nehmen. Bewahren Sie die Anleitung zum Nachlesen auf. Die Stromversorgung darf nur durch fachkundiges und qualifiziertes Personal installiert werden.

Bestimmungsgemäßer Gebrauch:

Dieses Gerät ist für den Einbau in ein Gehäuse konzipiert und zur Verwendung für allgemeine elektronische Geräte, wie z.B. Industriesteuerungen, Kommunikationsgeräte oder Messgeräte geeignet. Benutzen Sie dieses Gerät nicht in Steuerungsanlagen von Flugzeugen, Zügen oder atomaren Einrichtungen, in denen eine Funktionsstörung zu schweren Verletzungen führen oder Lebensgefahr bedeuten kann.

<p>⚠ WARNUNG !</p> <p>Missachtung nachfolgender Punkte kann einen elektrischen Schlag, Brände, schwere Unfälle oder Tod zur Folge haben.</p> <p>(1) Betreiben Sie die Stromversorgung nie ohne Schutzleiter!</p> <p>(2) Schalten Sie die Netzspannung vor Installations-, Wartungs- oder Änderungsarbeiten ab und sichern Sie gegen unbeabsichtigtes Wiedereinschalten.</p> <p>(3) Sorgen Sie für eine ordnungsgemäße und fachgerechte Verdrahtung.</p> <p>(4) Führen Sie keine Änderungen oder Reparaturversuche am Gerät durch.</p> <p>(5) Gerät niemals öffnen. Im Inneren befinden sich gefährliche Spannungen.</p> <p>(6) Verhindern Sie das Eindringen von Fremdkörpern, wie z.B. Büroklammern und anderen Metallteilen.</p> <p>(7) Betreiben Sie das Gerät nicht in feuchter Umgebung.</p> <p>(8) Betreiben Sie das Gerät nicht in einer Umgebung, bei der mit Betauung oder Kondensation zu rechnen ist.</p>	<p>⚠ VORSICHT !</p> <p>Rücknahme der Ausgangsleistung kann erforderlich sein:</p> <p>(1) wenn die minimalen Einbaubstände nicht eingehalten werden können.</p> <p>(2) bei Aufstellhöhen über 2000m.</p> <p>(3) Betrieb bei Umgebungstemperaturen über 60°C.</p> <p>(4) bei Einbaulagen abweichend von der Standardeinbaulage (Eingang unten, Ausgang oben).</p> <p>(5) bei behinderter Luftzirkulation.</p> <p>Weitere Informationen zur Leistungsrücknahme befinden sich in dieser Betriebsanleitung. Gehäuse nicht während des Betriebes oder kurz nach dem Abschalten berühren. Heiße Oberflächen können Verletzungen verursachen. Das Gerät beinhaltet keine Servicebauteile. Interne Sicherungen lösen nur bei Gerätedefekt aus. Bei Funktionsstörungen oder Beschädigungen schalten Sie sofort die Versorgungsspannung ab und senden das Gerät zur Überprüfung ins Werk.</p>
---	---

Die angegebenen Daten dienen allein der Produktbeschreibung und sind nicht als zugesicherte Eigenschaften im Rechtssinne aufzufassen. Im Zweifelsfall gilt der englische Text

Hinweise für den Betrieb in explosionsgefährdeter Umgebung	<p>ACHTUNG EXPLOSIONSGEFAHR !</p> <p>Geräte die am Leistungsschild mit "Class I Div 2" gekennzeichnet sind, sind für den Einsatz in Klasse I Division 2 Gruppen A,B,C,D oder für explosions-ungefährliche Aufstellorte geeignet. Veränderungen an Bauteilen können die Tauglichkeit für Klasse I Division 2 beeinträchtigen. Anschlüsse nicht trennen solange Spannung anliegt. Anschluss muss unter Berücksichtigung der Anforderungen nach Klasse I Division 2 Artikel 501-4(b) des National Electrical Code, NFPA 70 erfolgen.</p>
---	--

A lire avant mise sous tension !

Français **3**

Merci de lire ces instructions de montage et d'entretien avant de mettre l'alimentation sous tension. Conservez ce manuel qui vous sera toujours utile. Cette alimentation doit être installée par du personnel qualifié et compétent.

Utilisation:

Cet appareil est conçu pour être installé dans une armoire et pour tous les équipements électroniques, tel que l'équipement industriel de commande, l'équipement de bureau, le matériel de communication et les instruments de mesures. N'utilisez pas cet appareil pour l'équipement de commandes dans les avions, les trains et l'équipement atomique où un problème de fonctionnement de l'alimentation pourrait causer des blessures graves ou menacer la vie humaine.

<p>⚠ ATTENTION !</p> <p>Prendre en compte les points suivants, afin d'éviter toute détérioration électrique, incendie, dommage aux personnes ou mort.</p> <p>(1) ne jamais faire fonctionner l'alimentation sans raccordement à la terre !</p> <p>(2) débrancher l'installation avant toute intervention sur l'alimentation (ou démontage) et s'assurer qu'il n'y a pas risque de redémarrage.</p> <p>(3) s'assurer que le câblage a été fait selon les prescriptions</p> <p>(4) ne pas effectuer de réparations ou modifications sur l'alimentation</p> <p>(5) ne pas ouvrir l'appareil. Des tensions importantes passent à l'intérieur.</p> <p>(6) veiller à ce qu'aucun objet ne rentre en contact avec l'intérieur de l'alimentation (trombones, pièces métalliques)</p> <p>(7) ne pas faire fonctionner l'appareil dans un environnement humide ou à l'extérieur, non protégé</p> <p>(8) ne pas utiliser l'appareil dans un environnement où il peut y avoir de la condensation.</p>	<p>⚠ ATTENTION !</p> <p>Des limitations de puissance de sortie peuvent apparaître si :</p> <p>(1) les distances d'installation mini. ne peuvent être observées</p> <p>(2) installation à une altitude > 2000 m</p> <p>(3) pour des fonctionnements en charge et avec une température ambiante > 60°C</p> <p>(4) pour des positions de montage différentes de la préconisation standard (entrée dessous, sortie en haut)</p> <p>(5) lorsque la circulation d'air est gênée</p> <p>D'autres informations sont disponibles dans la documentation de mise en service</p> <p>Ne pas toucher le carter pendant le fonctionnement ou après la mise sous tension. Surface chaude risquant d'entraîner des blessures.</p> <p>Le déclenchement du fusible interne traduit très probablement un défaut au niveau de l'appareil. Si un défaut quelconque apparaît en cours de fonctionnement, débrancher au plus vite l'alimentation. Dans ce deux cas de figure, il convient de faire contrôler l'alimentation en usine!</p>
--	--

Les données indiquées dans ce document servent uniquement à donner une description du produit et n'ont aucune valeur juridique. En cas de doute, veuillez vous reporter au texte anglais.

Utilisation Class I Div 2	<p>ATTENTION RISQUE D' EXPLOSION Les appareils portant la marque "Class I Div 2" au niveau de la plaque signalétique sont prévus pour fonctionner en Classe I, Division 2, Groupes A,B,C,D ou pour un environnement non explosif et non dangereux.</p> <p>Le remplacement de composants peut rendre le matériel impropre à une utilisation en Classe 1, Division 2.</p> <p>Ne déconnecter l'équipement qu' hors tension ou en zone connue comme non dangereuse.</p> <p>Le raccordement doit obligatoirement tenir compte des exigences de la classe 1, division 2, article 501-4(b) du National Electrical Code, NFPA 70.</p>
----------------------------------	--

Conserve este manual como referencia para futuras consultas. La fuente de alimentación solo puede ser instalada y puesta en funcionamiento por personal cualificado. Por favor lea detenidamente este manual antes de conectar la fuente de alimentación.

Uso apropiado:

Este equipo ha sido diseñado para su instalación en un ambiente cerrado y ha sido concebido para uso general en instalaciones de control industrial, oficinas, comunicaciones y equipos de instrumentación. No emplee este equipo en aeronaves, trenes e instalaciones atómicas, donde un mal funcionamiento de la fuente de alimentación puede ocasionar lesiones graves o riesgo mortal.

<p>⚠ ADVERTENCIA !</p> <p>Riesgo de descarga eléctrica, incendio, accidente grave o muerte.</p> <ol style="list-style-type: none"> (1) No conectar nunca la unidad sin conexión de puesta a tierra. (2) Desconectar la tensión de red antes de trabajar en la fuente de alimentación. Evite una posible reconexión involuntaria. (3) Asegurarse de que el cableado es correcto de acuerdo a los códigos locales y nacionales. (4) No realizar ninguna modificación o reparación de la unidad. (5) No abrir nunca la unidad. En el interior existe riesgo de altas tensiones. (6) Evitar la introducción en la carcasa de objetos extraños. (7) No usar el equipo en ambientes húmedos. (8) No operar el equipo en ambientes donde se espere la formación de rocío o condensación. 	<p>⚠ CUIDADO !</p> <p>La deriva en la tensión de salida se produce:</p> <ol style="list-style-type: none"> (1) cuando no pueden mantenerse las distancias mínimas de montaje. (2) en caso de que el montaje se realice en altitudes superiores a los 2000 m. (3) en caso de funcionamiento a plena carga y temperaturas ambientales superiores a 60° C. (4) En caso de posicionamiento de montaje diferentes a la posición de montaje estándar (terminales de entrada abajo y terminales de salida arriba). (5) en caso de que la circulación de aire para la refrigeración por conducción esté obstruida. <p>Puede encontrar más detalles del caso de deriva en este manual.</p> <p>No tocar durante el funcionamiento ni inmediatamente después del apagado. El calor de la superficie puede causar quemaduras graves.</p> <p>Cuando se funde un fusible interno, existe gran probabilidad de un fallo interno en el equipo. Si se produce un fallo o mal funcionamiento durante la operación, desconecte inmediatamente la tensión de alimentación. En ambos casos, el equipo debe ser inspeccionado en fábrica.</p>
--	---

La información presentada en este documento es exacta y fiable en cuanto a la descripción del producto y puede cambiar sin aviso. En casa de duda, prevalece el texto inglés.

Uso apropiado	ATENCIÓN PELIGRO DE EXPLOSIÓN! Los equipos marcados con la expresión "Class I Div 2" son adecuados para su uso en ambientes no peligrosos y en entornos con la Clase I División 2 Grupos A, B, C, D. La sustitución de componentes puede perjudicar la idoneidad para la Clase I División 2.
Class I Div 2	No desconecte el equipo a menos que la tensión de alimentación esté desconectada. El conexionado debe cumplir con la Clase I División 2 métodos de conexión del Código Nacional Eléctrico NFPA 70 o con el resto de códigos locales o nacionales.

Leggere prima questa parte!

Prima di collegare il sistema di alimentazione elettrica si prega di leggere attentamente le seguenti avvertenze. Conservare le istruzioni per la consultazione futura. Il sistema di alimentazione elettrica deve essere installato solo da personale competente e qualificato.

Uso previsto:

Questo apparecchio è previsto per il montaggio in un rack per moduli elettronici, ad esempio per controllori industriali, apparecchiature per ufficio, unità di comunicazione o apparecchi di misura. Non utilizzare l'apparecchio in impianti di controllo di aerei, di treni o di impianti nucleari in cui il suo eventuale guasto può comportare gravi lesioni o la morte di persone.

<p>⚠ AVVERTENZA!</p> <p>Il mancato rispetto delle seguenti norme può provocare folgorazione elettrica, incendi, gravi incidenti e perfino la morte.</p> <ol style="list-style-type: none"> (1) Non far funzionare in nessun caso il sistema di alimentazione elettrica senza conduttore di protezione! (2) Prima di eseguire interventi di installazione, di manutenzione o di modifica scollegare la tensione di rete ed adottare tutti i provvedimenti necessari per impedirne il ricollegamento non intenzionale. (3) Assicurare un cablaggio regolare e corretto. (4) Non tentare di modificare o di riparare da soli l'apparecchio. (5) Non aprire l'apparecchio. Al suo interno sono applicate tensioni elettriche pericolose. (6) Impedire la penetrazione di corpi estranei nell'apparecchio, ad esempio fermagli o altri oggetti metallici. (7) Non far funzionare l'apparecchio in un ambiente umido. (8) Non far funzionare l'apparecchio in un ambiente soggetto alla formazione di condensa o di rugiada. 	<p>⚠ CAUTELA !</p> <p>È necessario ridurre la potenza di uscita se:</p> <ol style="list-style-type: none"> (1) non è possibile rispettare le distanze minime di montaggio; (2) l'apparecchio viene installato in un luogo di altitudine maggiore di 2000 m; (3) il funzionamento è a pieno carico a temperatura ambiente maggiore di 60 °C; (4) la posizione di montaggio differisce da quella standard (ingresso in basso, uscita in alto); (5) è ostacolata la libera circolazione dell'aria. <p>Ulteriori informazioni sono riportate in questo manuale.</p> <p>Non toccare quando acceso e subito dopo lo spegnimento. La superficie calda può causare scottature.</p> <p>In caso di intervento del fusibile interno, molto probabilmente l'apparecchio è guasto.</p> <p>Se durante il funzionamento si verificano anomalie o guasti, scollegare immediatamente la tensione di alimentazione.</p> <p>In entrambi i casi è necessario far controllare l'apparecchio dal produttore!</p>
---	--

I dati sono indicati solo a scopo descrittivo del prodotto e non vanno considerati come caratteristiche garantite dell'apparecchio. In caso di differenze o problemi è valido il testo inglese

Uso previsto	ATTENZIONE: PERICOLO DI ESPLOSIONE! Gli apparecchi la cui targhetta riporta "Class I Div 2" sono adatti per l'impiego in ambienti di classe I, divisione 2, gruppi A, B, C e D o non soggetti al pericolo di esplosione. La modifica dei componenti possono influenzare negativamente l'idoneità per ambienti di classe I, divisione 2. Non aprire i morsetti con tensione di alimentazione collegata. Il collegamento deve essere eseguito nel rispetto dei requisiti previsti dalla classe I, divisione 2, articolo 501-4(b) del National Electrical Code, NFPA 70.
Class I Div 2	

Leia primeiro!

Recomendamos a leitura cuidadosa das seguintes advertências e observações, antes de colocar em funcionamento a fonte de alimentação. Guarde as Instruções para futura consulta, em casos de dúvida. A fonte de alimentação deverá ser instalada apenas por profissionais da área, tecnicamente qualificados.

Utilize:

apenas para o fim pré-estabelecido. Este aparelho foi concebido para ser montado dentro de invólucros, caixas ou armários para aparelhos eletrônicos em geral, como, por exemplo, comandos de instalações industriais, aparelhos para escritórios, aparelhos de comunicação ou instrumentos de medida e quadros elétricos. Não utilize este aparelho em sistemas de comando de aviões, de comboios ou em instalações movidas por energia nuclear, nos quais um defeito de funcionamento poderá causar danos graves ou significar risco de morte.

<p>⚠ ATENÇÃO !</p> <p>A não observância ou o incumprimento dos pontos a seguir mencionados, poderá causar uma descarga elétrica, incêndios, acidentes graves ou morte.</p> <ol style="list-style-type: none"> (1) Não use a fonte de alimentação sem o condutor de proteção terra! (2) Antes de trabalhos de instalação, manutenção ou modificação, desligue a tensão de alimentação, protegendo-a contra uma nova ligação involuntária. (3) As ligações devem ser efectuadas apenas por profissionais competentes. (4) Não efectue nenhuma modificação ou tentativa de reparação no aparelho. Quando necessário contacte o seu distribuidor. (5) Não abra o aparelho mesmo quando desligado. No seu interior existem condensadores que podem estar carregados electricamente. (6) Proteger a fonte de alimentação contra a introdução inadvertida de corpos metálicos, como por ex., cliques ou outras peças de metal. (7) Não usar o aparelho em ambientes húmidos. (8) Não usar o aparelho em ambientes propensos a condensações. 	<p>⚠ CUIDADO !</p> <p>Será necessário reduzir a potência de saída nos seguintes casos:</p> <ol style="list-style-type: none"> (1) Quando não forem observadas as distâncias mínimas de montagem. (2) Quando instaladas a altitudes superiores a 2000m. (3) Existência de temperatura ambiente superior a 60°C, em plena carga do aparelho. (4) Montagem invertida do aparelho (Entrada em baixo, saída em cima). (5) Montagem em ambiente sem ventilação. <p>No presente manual de funcionamento encontram-se ainda outras informações.</p> <p>Não tocar enquanto estiver em funcionamento, nem após a desligar. A superfície poderá estar quente e provocar lesões.</p> <p>Se o fusível interno se fundir, é grande a possibilidade de existir um defeito no aparelho. Se por acaso, durante a utilização ocorrer algum defeito de funcionamento ou dano, desligue imediatamente a tensão de alimentação.</p> <p>Em ambos os casos, será necessária uma verificação na Fábrica!</p>
---	--

Os dados mencionados têm como finalidade somente a descrição do produto, e não devem ser interpretados como propriedades garantidas no sentido jurídico. Em caso de dúvidas, aplica-se o texto em Inglês.

Utilize	ATENÇÃO, RISCO DE EXPLOÇÃO ! Aparelhos que contêm na sua placa de dados elétricos o texto "Class I Div 2" são apropriados para a aplicação na Classe I, divisão 2, Grupos A, B, C, D ou também para locais de instalação isentos de riscos de explosão.
Class I Div 2	Modificações efectuadas em componentes podem restringir ou reduzir a adequação para aplicação na Classe I, Divisão 2. As ligações não devem ser separadas enquanto estiverem ligadas a uma fonte de alimentação elétrica. As ligações devem ser efetuadas levando-se em consideração as exigências normativas da Classe I, Divisão 2.

Germany	PULS in Munich	+49 89 9278 0	www.pulspower.com	Headquarters: PULS GmbH Arabellastrasse 15 D-81925 Munich Germany
China	PULS in Shanghai	+86 21 6432 7680	www.puls-power.cn	
France	PULS in Limonest / Lyon	+33 478 668 941	www.pulspower.com/fr	
North America	PULS in St. Charles / Chicago	+1 630 587 9780	www.puls-power.us	
Austria	PULS in Rohrbach	+43 27 64 32 13	www.pulspower.com	
Switzerland	PULS in Oberflachs / Aargau	+41 56 450 18 10	www.puls-power.ch	
United Kingdom	PULS in Bedfordshire	+44 845 130 1080	www.puls.co.uk	

MiniLine Power Supply Instruction Manual

Technical Data	Technische Daten	Single Phase Input				
		ML95.100	ML100.100	ML100.102	ML100.105	ML100.109
Output Voltage	Ausgangsspannung	24-28V	24-28V	12-15V	48-56V	24-28V
Factory Set ¹⁾	Werkseinstellung ¹⁾	typ. 24.5V	24.5V	12.0V	48.0V	24.5V
Output Current	Ausgangsstrom	nom. 3.95-3.4A	4.2-3.6A	7.5-6A	2.1-1.8A	4.2-3.6A
Output Power	Ausgangsleistung	nom. 95W	100W	90W	100W	100W
Output Ripple ²⁾	Ausgangswelligkeit ²⁾	max. 50mVpp	50mVpp	50mVpp	100mVpp	50mVpp
AC Input Voltage	AC Eingangsspannung	- 100-120V / 220-240V -15% +10%	100-120V / 220-240V -15% +10%	100-120V / 220-240V -15% +10%	100-120V / 220-240V -15% +10%	100-120V / 220-240V -15% +10%
AC Input Current ¹⁾	AC Eingangsstrom ¹⁾	typ. 1.63 / 0.95A	1.72 / 1.0A	1.57 / 0.91A	1.72 / 1.0A	1.72 / 1.0A
DC Input Voltage	DC Eingangsspannung	- 220-375Vdc	220-375Vdc	220-375Vdc	220-375Vdc	220-375Vdc
Power Factor ¹⁾	Leistungsfaktor ¹⁾	typ. 0.56 / 0.5	0.56 / 0.5	0.56 / 0.5	0.56 / 0.5	0.56 / 0.5
EN 61000-3-2 ⁵⁾	EN 61000-3-2 ⁵⁾	yes / ja	yes / ja	yes / ja	yes / ja	yes / ja
Inrush Current ³⁾	Einschaltspitzenstrom ³⁾	typ. 22A; 1.4A ² s	22A; 1.4A ² s	22A; 1.4A ² s	22A; 1.4A ² s	22A; 1.4A ² s
Efficiency ¹⁾	Wirkungsgrad ¹⁾	typ. 88.5 / 90.0%	87.7 / 88.5%	88.5 / 90.0%	90.4 / 91.8%	88.5 / 90.0%
Losses ¹⁾	Verlustleistung ¹⁾	typ. 11.6 / 9.9W	12.6 / 11.7W	13.0 / 11.1W	10.6 / 8.9W	11.6 / 9.9W
Hold-up Time ¹⁾	Pufferzeit ¹⁾	typ. 41 / 46ms	38 / 44ms	41 / 46ms	38 / 44ms	41 / 46ms
Single/Parallel Jumper	Einzel/Parallelbetr. Brücke	no / nein	yes / ja	yes / ja	yes / ja	yes / ja
Dimensions (wxhxd) ⁴⁾	Abmessungen (BxHxT) ⁴⁾	73x75x103mm	73x75x103mm	73x75x103mm	73x75x103mm	73x75x103mm
Weight	Gewicht	max. 360g / 0.79lb	360g / 0.79lb	360g / 0.79lb	360g / 0.79lb	360g / 0.79lb
Special Features	Besonderheiten	NEC Class 2	--	--	--	conf. coated Schutzlack
Limited Warranty (Years)	Gewährleistung (Jahre)	- 3	3	3	3	3

- 1) At full load
- 2) 50Ohm measurement, bandwidth 20MHz
- 3) Peak value and inrush energy at an ambient temperature of 40°C and cold start.
- 4) Without DIN-rail
- 5) EN 61000-3-2 is the European standard for harmonic current emission (PFC)

- 1) bei Nennlast
- 2) 50 Ohm Messung, Bandbreite 20MHz
- 3) Spitzenstrom und Einschaltenergie bei einer Umgebungstemperatur von 40°C und Kaltstart.
- 4) Tiefe ohne DIN-Schiene
- 5) Die EN 61000-3-2 ist der EU Standard zur Festlegung der zulässigen Oberwellenströme die ein Gerät erzeugen darf.

380-480V Input	
ML90.200	ML100.200
Output Voltage	24-28V
Factory Set ¹⁾	24.5V
Output Current	3.75-3.2A
Output Power	90W
Output Ripple ²⁾	50mVpp
AC Input Voltage	380-480Vac ±15%
AC Input Current ¹⁾	0.42 / 0.36A
DC Input Voltage	--
Power Factor ¹⁾	0.6 / 0.55
EN 61000-3-2 ⁵⁾	yes / ja
Inrush Current ³⁾	36A; 1A ² s
Efficiency ¹⁾	89.5 / 89.0%
Losses ¹⁾	10.5 / 11.1W
Hold-up Time ¹⁾	52 / 93ms
Single/Parallel Jumper	no / nein
Dimensions (wxhxd) ⁴⁾	73x75x103mm
Weight	360g / 0.79lb
Special Features	NEC Class 2
Limited Warranty (Years)	3

Functional Diagrams / Funktionsschaltbilder

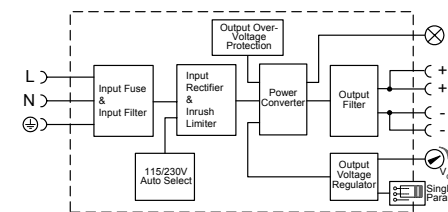

ML100.100, ML100.102, ML100.105, ML100.109

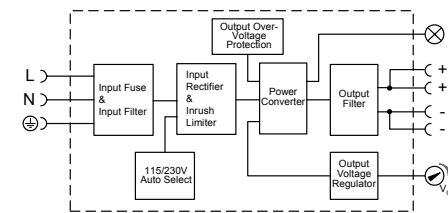

ML95.100

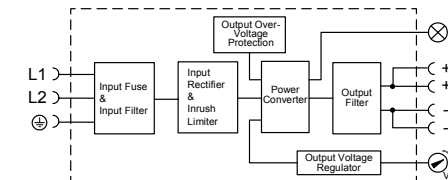

ML90.200, ML100.200

Overload Performance / Überlastverhalten

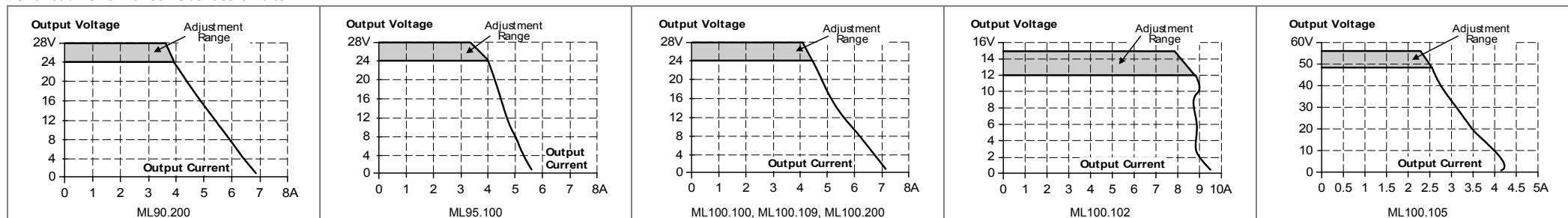

EMC Electromagnetic Compatibility

These devices are suitable for applications in industrial environment as well as in residential, commercial and light industry environment without any restrictions. These devices comply with FCC Part 15 rules. Operation is subjected to following two conditions: (1) this device may not cause harmful interference, and (2) this device must accept any interference received, including interference that may cause undesired operation. CE mark is in conformance with EMC guideline 89/336/EEC, 93/68/EEC and the low-voltage directive (LVD) 73/23/EEC, 93/68/EEC.

EMC Immunity	EMV Störfestigkeit	EN 61000-6-1, EN 61000-6-2
EMC Emission	EMV Störaussendung	EN 61000-3-2, EN 61000-3-3, EN 61000-6-3, EN 61000-6-4, FCC Part 15 Class B

EMV Elektromagnetische Verträglichkeit

Diese Geräte erfüllen die Anforderungen für Anwendungen in industrieller Umgebung als auch für den Wohn-, Geschäfts- und Gewerbebereich ohne Einschränkungen. Die Geräte erfüllen auch die Anforderungen der FCC Teil 15. Das CE Zeichen ist angebracht und erklärt die Erfüllung der EMC Richtlinien 89/336/EWG, 93/68/EWG und der Niederspannungsrichtlinie 73/23/EWG, 93/68/EWG.

MiniLine Power Supply Instruction Manual

Environmental conditions	Umgebungsbedingungen	
Operational temperature range	Betriebstemperaturbereich	-10 to +70°C
Output Derating	Leistungsrücknahme	2,5%/°C, >60°C
Storage temperature	Lagertemperaturbereich	-40 to +85° C
Humidity, IEC 60068-2-30 *)	Feuchte, IEC 60068-2-30 *)	< 95% r. H.
Vibration, IEC 60068-2-6	Schwingen, IEC 60068-2-6	2g
Shock, IEC 60068-2-27	Schocken, IEC 60068-2-27	30g 6ms, 20g 11ms
Degree of pollution, EN 50178	Verschmutzungsgrad, EN 50178	2

Fuses

Internal input fuse: 3.15A time lag (Device protection, not externally accessible)

The unit is tested and approved for branch circuits up to 20A. External protection is only required if the supplying branch has an ampacity greater than this. In some countries local regulations might apply. Check also local codes and local requirements. If an external fuse is necessary or utilized, minimum requirements need to be considered. To avoid nuisance tripping of the circuit breaker, use a min. value of 6A C-Characteristic.

*) Do not energize while condensation is present / Nicht betreiben solange das Gerät Kondensation aufweist

Protections	Schutzfunktionen	
Overload, short-circuit proof	Überlast, Kurzschlussschutz	yes / ja
Degree of protection	Schutzart	IP 20, EN/IEC 60529
Class of protection	Schutzklasse	I
Over-voltage category	Überspannungskategorie	III, EN 50178
Over-temperature protection	Übertemperaturschutz	no / nein
Output over-voltage protection	Überspannungsschutz Ausgang	yes / ja
Penetration protection	Fremdkörper Eindringenschutz	>3.5mm

Sicherungen

Interne Gerätesicherung: 3.15A träge (Gerätesicherung, nicht austauschbar durch Anwender)

Das Gerät ist geprüft und zugelassen zum Anschluss an Stromkreisen bis max. 20A. Zusätzlicher externer Schutz ist nur erforderlich wenn der Speisestromkreis mit einem höheren Wert abgesichert ist oder nationale Richtlinien es vorschreiben. Falls ein externes Schutzelement verwendet wird, soll dieses nicht kleiner als 6A (C- Charakteristik) sein um ein fehlerhaftes Auslösen zu vermeiden.

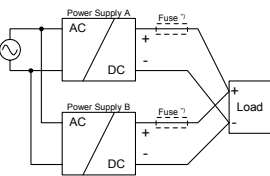

Parallel Operation
All units except ML90.200 and ML95.100 can be used in parallel to get redundancy or to gain higher output power.
(1) Use only power supplies from the same series.
(2) Adjust the power supplies to parallel mode if a single/parallel mode jumper is available.
(3) A fuse (or diode) on the output is only required if more than three units are paralleled.
(4) Keep an installation clearance of 15mm (left/right) between two power supplies and avoid installing the power supplies on top of each other.

Parallel Betrieb
Alle Geräte mit Ausnahme des ML90.200 und ML95.100 können zur Erhöhung der Ausgangsleistung oder für Redundanzzwecke parallel betrieben werden.
(1) Verwenden Sie nur gleiche Stromversorgungen.
(2) Stellen Sie die Stromversorgung in den „Parallel Mode“ wenn ein Single/Parallel Mode Jumper vorhanden ist.
(3) Eine Sicherung oder Diode wird nur benötigt, wenn mehr als drei Geräte parallel geschaltet werden.
(4) 15mm seitlicher Installationsabstand (links/rechts) zwischen den einzelnen Stromversorgungen sind einzuhalten. Verwenden Sie die Geräte nicht übereinander.

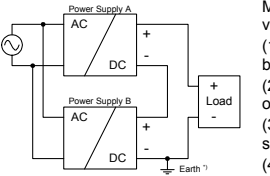

Series Operation
All units except ML90.200, ML95.100 and ML100.102 can be used in series to get a sum voltage of up to 150Vdc max.
(1) Voltages with a potential above 60Vdc must be installed with a protection against touching.
(2) For serial operation use only power supplies of the same type.
(3) Earthing of the output is required when the sum of the output voltage is above 60Vdc.
(4) Keep an installation clearance of 15mm (left/right) between two power supplies and avoid installing the power supplies on top of each other.

Betrieb in Serienschaltung
Alle Geräte mit Ausnahme ML90.200, ML95.100 und ML100.102 können bis zu einer Gesamtspannung von 150Vdc in Serie geschaltet werden.
(1) Spannungen über 60Vdc müssen berührgeschützt installiert werden.
(2) Verwenden Sie bei Serienschaltung nur gleiche Geräte
(3) Wenn die Gesamtspannung 60Vdc übersteigt, muss der Ausgang geerdet werden.
(4) 15mm seitlicher Installationsabstand (links/rechts) zwischen den einzelnen Stromversorgungen sind einzuhalten. Verwenden Sie die Geräte nicht übereinander.

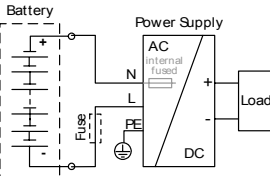

Operation with DC Input
All units except ML90.200 and ML100.200 will operate with a DC input voltage.
(1) Use a battery or similar DC source.
(2) Connect -pole to L and +pole to N
(3) Connect the ground terminal of the power supply to a PE wire or to machine ground.

Betrieb an einer DC Eingangsspannung
Alle Geräte mit Ausnahme des ML90.200 und ML100.200 können an einer DC Eingangsspannung betrieben werden.
(1) Verwenden Sie eine Batterie oder ähnliche Quelle
(2) Schließen Sie den -Pol an L und +Pol an N an
(3) Schließen Sie den Schutzleiteranschluss an die Schutzerde oder an die Maschinenmasse an.

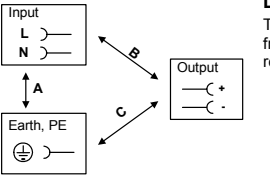

Dielectric Strength
The output voltage is floating and separated from the input according to SELV / PELV requirements.

Isolationsfestigkeit
Die Ausgangsspannung hat keinen Bezug zur Erde oder Schutzleiter und ist zum Eingang nach den SELV und PELV Richtlinien getrennt.

	A	B	C
Type Test (60s)	2500Vac	3000Vac	500Vac
Factory Test (5s)	2500Vac	2500Vac	500Vac
Field Test (5s)	2000Vac	2000Vac	500Vac

Installation:

Use DIN-rails according to EN 60715 or EN 50022 with a height of 7.5 or 15mm. Mounting orientation must be output terminals on top and input terminals on the bottom. For other orientations see datasheet. Do not obstruct air flow! The unit is convection cooled. Ventilation grid must be kept free of any obstructions. The following installation clearances must be kept when permanently full loaded:

- Left / right: 0mm (15mm in case the adjacent device is a heat source)
- 40mm on top, 20mm on the bottom

Installation:

Geeignet für DIN-Schienen entsprechend EN 60715 oder EN 50022 mit einer Höhe von 7,5 oder 15mm. Der Einbau hat so zu erfolgen, dass sich die Eingangsklemmen unten, und die Ausgangsklemmen oben befinden. Für andere Einbaulagen siehe Datenblatt. Luftzirkulation nicht behindern! Das Gerät ist für Konvektionskühlung ausgelegt. Es ist für ungehinderte Luftzirkulation zu sorgen. Die folgende Einbauabstände sind bei dauerhafter Vollast einzuhalten:

- Links / rechts: 0mm (15mm wenn das benachbarte Geräte eine Wärmequelle ist)
- Oben: 40mm, unten 20mm

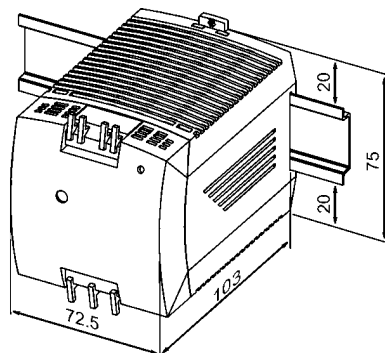

Terminals and Wiring:

Do not use the unit without PE (Ground) connection! Use appropriate copper cables that are designed for an operating temperatures of 60°C (for ambient up to 45°C) and 75°C (for ambient up to 60°C), minimum. Follow national installation codes and regulations! Ensure that all strands of a stranded wire enter the terminal connection! Up to two stranded wires with the same cross section are permitted in one connection point (except PE wire). Ferrules are allowed, but not required.

Spring-clamp terminals

Solid wire
Stranded wire
American wire gauge
Wire stripping length
Pull-out force

Federkraftklemmen

Starrdraht
Litze
AWG
Abisolierlänge
Ausziehkraft

0.3-4mm²
0.3-2.5mm²
26-12 AWG
6mm / 0.25inch
50N (14AWG, UL486E)

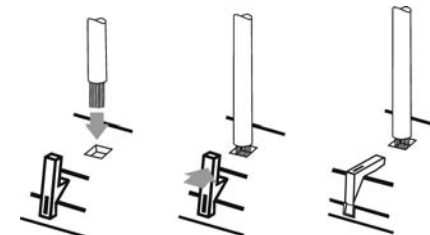

Anschlussklemmen und Verdrahtung:

Betreiben Sie das Gerät nie ohne Schutzleiter. Verwenden Sie geeignete Kupferkabel, die mindestens für 60°C (bei einer Umgebungstemperatur bis zu 45°C) und 75°C (bei einer Umgebungstemperatur bis zu 60°C) zugelassen sind. Beachten Sie nationale Bestimmungen und Installationsvorschriften! Stellen Sie sicher, dass keine einzelnen Drähte von Litzen abstehen. Bis zu zwei Leiter mit gleichem Querschnitt sind in einem Anschlusspunkt zulässig (außer für den Schutzleiter). Aderendhülsen sind erlaubt, aber nicht erforderlich.