

WallSkim ACTIVE 12.000



-  **DE** Gebrauchsanweisung
-  **GB** Instructions for use
-  **FR** Mode d'emploi
-  **NL** Gebruiksaanwijzing
-  **ES** Instrucciones de uso
-  **PT** Instruções de uso
-  **IT** Istruzioni per l'uso
-  **DK** Brugsanvisning
-  **NO** Instruksjoner for bruk
-  **SE** Användningsinstruktioner

-  **FI** Käyttöohjeet
-  **HU** Használati útmutató
-  **PL** Instrukcja użycia
-  **CZ** Návod k použití
-  **RO** Instrucțiuni de folosire
-  **BG** Инструкции за употреба
-  **UA** Інструкція на ўжыванні
-  **RU** Инструкции по применению
-  **TR** Kullanım için talimatlar
-  **GR** Οδηγίες χρήσης



WallSkim ACTIVE 12.000

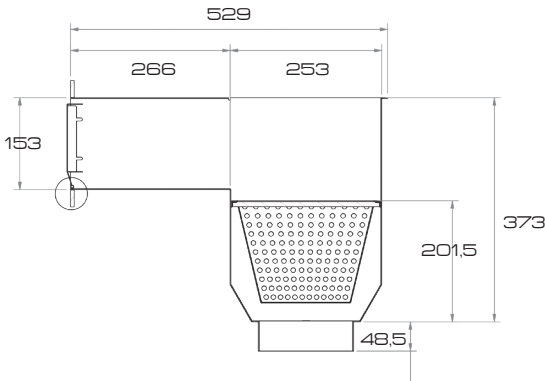
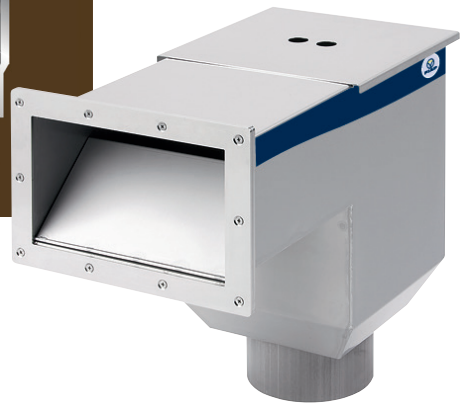

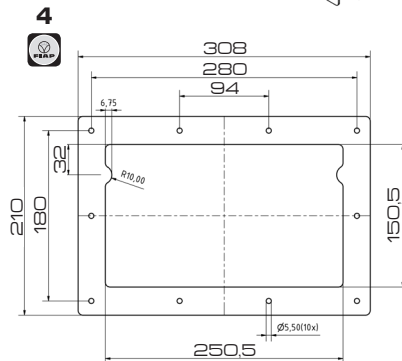
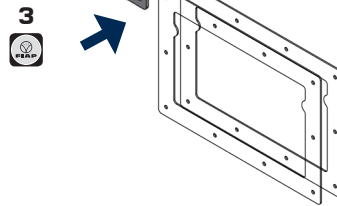
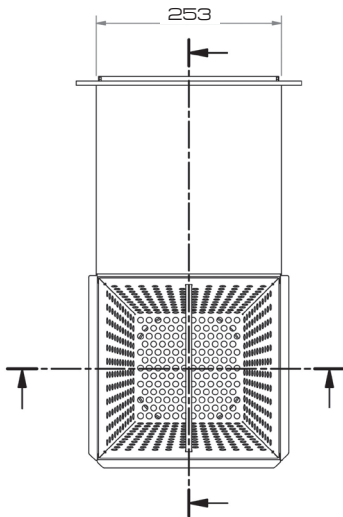
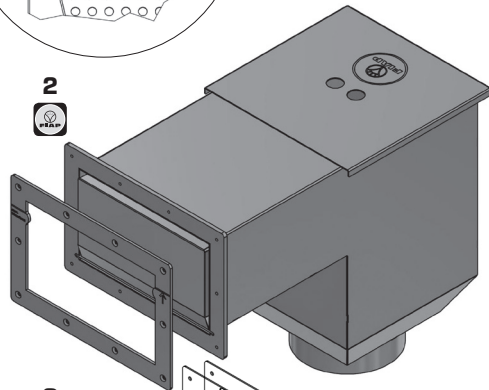
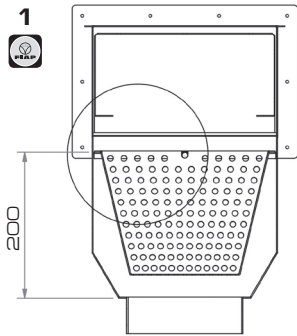



FIAP GmbH

Jakob - Oswald - Str. 16
92289 Ursensollen
GERMANY

+49 9628 9213-0

info@fiap.de

www.fiap.com



Technische Änderungen vorbehalten.
Für Druckfehler übernehmen wir keine Haftung.
WEEE-Reg. Nr.: DE78152045