

Fiche technique | Numéro d'article: 280-880

Borne sectionnable et de mesure pour 2 conducteurs; avec rail de contact pour continuité de blindage; avec ouverture de test; pour fiche de test Ø 2 mm et Ø 3 mm; Pour rail 35 x 15 et 35 x 7,5; 2,5 mm²; CAGE CLAMP®

www.wago.com/280-880

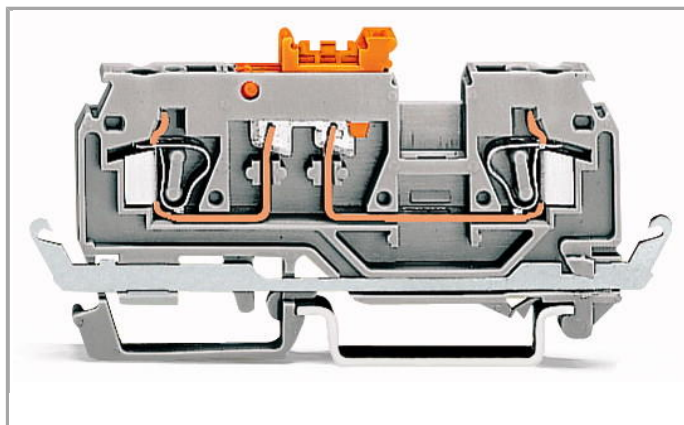

RoHS
Compliant

BOMcheck.net

Couleur: ■

Données

Données électriques

Ratings per IEC/EN 60664-1

Tension de référence (III / 3)	250 V
Tension assignée de tenue aux chocs (III / 3)	4 kV
Courant	16 A
Légende Données de référence	(III / 3) ≙ Catégorie de surtension III / degré de pollution 3

Données de raccordement

Technique de connexion	CAGE CLAMP®
Type d'actionnement	Outil de manipulation
Matière plastique conducteur raccordable	Cuivre aluminium
Conducteur rigide	0,08 ... 2,5 mm ² / 28 ... 12 AWG
Conducteur souple	0,08 ... 2,5 mm ² / 28 ... 12 AWG
Longueur de dénudage	8 ... 9 mm / 0.31 ... 0.35 inch
Nombre total des points de serrage	2
Nombre total des potentiels	2
nombre des niveaux	1
Type de câblage	câblage frontal

Données géométriques

Largeur	5 mm / 0.197 inch
Profondeur à partir du niveau supérieur du rail	28,5 mm / 1.122 inch
Profondeur	82 mm / 3.228 inch

Données mécaniques

Mode de construction	type horizontal
Type de montage	Rail 35
Niveau de marquage	Marquage central/latéral

Données du matériau

Couleur	orange
Matière isolante	Polyamide 66 (PA 66)
Charge calorifique	0.148 MJ
Poids	10.179 g

Dates commerciales



Country of origin	CN
GTIN	4050821180999
Customs Tariff No.	85365080990
Product Group	1 (Rail Mounted Terminal Blocks)

Autorisations / certificats

Approbations spécifiques au pays

Logo	Approbation	Nom du certificat
	CCA DEKRA Certification B.V.	2157201.01

Approbations de navire













Logo	Approbation	Nom du certificat
	ABS American Bureau of Shipping	14-HG1293677-PDA
	LR Lloyds Register	91/20112 (E9)















Produits correspondants

End plate

	N° art.: 280-371 Plaque d'extrémité et intermédiaire; épaisseur 2,5 mm	www.wago.com/280-371
	N° art.: 280-374 Plaque d'extrémité et intermédiaire; épaisseur 2,5 mm	www.wago.com/280-374

Marking accessories

	N° art.: 2009-115 WMB-Inline; pour smartPRINTER; sur rouleau; extensible 5 - 5,2 MM; vierge; encliquetable	www.wago.com/2009-115
	N° art.: 2009-115/000-002 WMB-Inline; pour smartPRINTER; sur rouleau; extensible 5 - 5,2 MM; vierge; encliquetable	www.wago.com/2009-115/000-002
	N° art.: 2009-115/000-006 WMB-Inline; pour smartPRINTER; sur rouleau; extensible 5 - 5,2 MM; vierge; encliquetable	www.wago.com/2009-115/000-006
	N° art.: 2009-115/000-007 WMB-Inline; sur rouleau; extensible 5 - 5,2 MM; vierge; encliquetable	www.wago.com/2009-115/000-007
	N° art.: 2009-115/000-012 WMB-Inline; pour smartPRINTER; sur rouleau; extensible 5 - 5,2 MM; vierge; encliquetable	www.wago.com/2009-115/000-012
	N° art.: 2009-115/000-017 WMB-Inline; sur rouleau; extensible 5 - 5,2 MM; vierge; encliquetable	www.wago.com/2009-115/000-017
	N° art.: 2009-115/000-023 WMB-Inline; pour smartPRINTER; sur rouleau; extensible 5 - 5,2 MM; vierge; encliquetable	www.wago.com/2009-115/000-023
	N° art.: 2009-115/000-024 WMB-Inline; pour smartPRINTER; sur rouleau; extensible 5 - 5,2 MM; vierge; encliquetable	www.wago.com/2009-115/000-024
	N° art.: 2009-145 Mini-WSB Inline; pour smartPRINTER; sur rouleau; extensible 5 - 5,2 MM; vierge; encliquetable	www.wago.com/2009-145
	N° art.: 2009-145/000-002 Mini-WSB Inline; sur rouleau; extensible 5 - 5,2 MM; vierge; encliquetable	www.wago.com/2009-145/000-002
	N° art.: 2009-145/000-005 Mini-WSB Inline; vierge; 1700 étiquettes Mini-WSB (5 mm) sur rouleau; extensible 5 - 5,2 MM	www.wago.com/2009-145/000-005
	N° art.: 2009-145/000-006 Mini-WSB Inline; pour smartPRINTER; sur rouleau; extensible 5 - 5,2 MM; vierge; encliquetable	www.wago.com/2009-145/000-006

	<p>N° art.: 2009-145/000-007 Mini-WSB Inline; vierge; 1 700 étiquettes Mini-WSB (5 mm) sur rouleau; extensible 5 - 5,2 MM</p>	www.wago.com/2009-145/000-007
	<p>N° art.: 2009-145/000-012 Mini-WSB Inline; pour smartPRINTER; sur rouleau; extensible 5 - 5,2 MM; vierge; encliquetable</p>	www.wago.com/2009-145/000-012
	<p>N° art.: 2009-145/000-023 Mini-WSB Inline; sur rouleau; extensible 5 - 5,2 MM; vierge; encliquetable</p>	www.wago.com/2009-145/000-023
	<p>N° art.: 2009-145/000-024 Mini-WSB Inline; sur rouleau; extensible 5 - 5,2 MM; vierge; encliquetable</p>	www.wago.com/2009-145/000-024
	<p>N° art.: 209-140 Porte-étiquettes de groupe</p>	www.wago.com/209-140
	<p>N° art.: 209-141 Porte-étiquettes de groupe</p>	www.wago.com/209-141
	<p>N° art.: 209-142 Porte-étiquettes de groupe</p>	www.wago.com/209-142
	<p>N° art.: 248-501 Système de repérage rapide Mini-WSB; vierge; Largeur d'étiquettes 5 mm; 10 bandes à 10 étiquettes par carte</p>	www.wago.com/248-501
	<p>N° art.: 248-501/000-002 Carte de repérage mini WSB; en carte; non extensible; vierge; encliquetable</p>	www.wago.com/248-501/000-002
	<p>N° art.: 248-501/000-005 Carte de repérage mini WSB; en carte; vierge; encliquetable</p>	www.wago.com/248-501/000-005
	<p>N° art.: 248-501/000-006 Carte de repérage mini WSB; en carte; non extensible; vierge; encliquetable</p>	www.wago.com/248-501/000-006
	<p>N° art.: 248-501/000-007 Carte de repérage mini WSB; en carte; non extensible; vierge; encliquetable</p>	www.wago.com/248-501/000-007
	<p>N° art.: 248-501/000-012 Carte de repérage mini WSB; en carte; non extensible; vierge; encliquetable</p>	www.wago.com/248-501/000-012
	<p>N° art.: 248-501/000-017 Carte de repérage mini WSB; en carte; non extensible; vierge; encliquetable</p>	www.wago.com/248-501/000-017
	<p>N° art.: 248-501/000-023 Carte de repérage mini WSB; en carte; non extensible; vierge; encliquetable</p>	www.wago.com/248-501/000-023



N° art.: 248-501/000-024
 Carte de repérage mini WSB; en carte; non extensible; vierge; encliquetable

www.wago.com/248-501/000-024



N° art.: 793-501
 Carte de repérage WMB; en carte; non extensible; vierge; encliquetable

www.wago.com/793-501



N° art.: 793-501/000-002
 Carte de repérage WMB; en carte; non extensible; vierge; encliquetable

www.wago.com/793-501/000-002



N° art.: 793-501/000-005
 Carte de repérage WMB; en carte; non extensible; vierge; encliquetable

www.wago.com/793-501/000-005



N° art.: 793-501/000-006
 Carte de repérage WMB; en carte; non extensible; vierge; encliquetable

www.wago.com/793-501/000-006



N° art.: 793-501/000-007
 Carte de repérage WMB; en carte; non extensible; vierge; encliquetable

www.wago.com/793-501/000-007



N° art.: 793-501/000-012
 Carte de repérage WMB; en carte; non extensible; vierge; encliquetable

www.wago.com/793-501/000-012



N° art.: 793-501/000-017
 Carte de repérage WMB; en carte; non extensible; vierge; encliquetable

www.wago.com/793-501/000-017



N° art.: 793-501/000-023
 Carte de repérage WMB; en carte; non extensible; vierge; encliquetable

www.wago.com/793-501/000-023



N° art.: 793-501/000-024
 Carte de repérage WMB; en carte; non extensible; vierge; encliquetable

www.wago.com/793-501/000-024



N° art.: 793-5501
 Carte de repérage WMB; en carte; largeur des bornes 5 - 17,5 mm; extensible 5 - 5,2 MM; vierge; encliquetable

www.wago.com/793-5501



N° art.: 793-5501/000-002
 Carte de repérage WMB; en carte; largeur des bornes 5 - 17,5 mm; extensible 5 - 5,2 MM; vierge; encliquetable

www.wago.com/793-5501/000-002



N° art.: 793-5501/000-005
 Carte de repérage WMB; en carte; extensible 5 - 5,2 MM; vierge; encliquetable

www.wago.com/793-5501/000-005



N° art.: 793-5501/000-006
 Carte de repérage WMB; en carte; extensible 5 - 5,2 MM; vierge; encliquetable

www.wago.com/793-5501/000-006



N° art.: 793-5501/000-007
 Carte de repérage WMB; en carte; extensible 5 - 5,2 MM; vierge; encliquetable

www.wago.com/793-5501/000-007



N° art.: 793-5501/000-012
Carte de repérage WMB; en carte; extensible 5 - 5,2 MM; vierge; encliquetable

www.wago.com/793-5501/000-012



N° art.: 793-5501/000-017
Carte de repérage WMB; en carte; extensible 5 - 5,2 MM; vierge; encliquetable

www.wago.com/793-5501/000-017



N° art.: 793-5501/000-023
Carte de repérage WMB; en carte; extensible 5 - 5,2 MM; vierge; encliquetable

www.wago.com/793-5501/000-023



N° art.: 793-5501/000-024
Carte de repérage WMB; en carte; extensible 5 - 5,2 MM; vierge; encliquetable

www.wago.com/793-5501/000-024

Carrier rail



N° art.: 210-112
Rail acier; 35 x 7,5; épaisseur 1 mm; longueur 2 m; perforé; d'après EN 60715; Largeur de trou 25 mm; pas des trous 36 mm www.wago.com/210-112

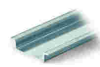

N° art.: 210-113
Rail acier; 35 x 7,5; épaisseur 1 mm; longueur 2 m; non perforé; d'après EN 60715 www.wago.com/210-113



N° art.: 210-114
Rail acier; 35 x 15; épaisseur 1,5 mm; longueur 2 m; non perforé; d'après EN 60715 www.wago.com/210-114



N° art.: 210-115
Rail acier; 35 x 7,5; épaisseur 1 mm; longueur 2 m; perforé; d'après EN 60715; Largeur de trou 18 mm; pas des trous 25 mm www.wago.com/210-115



N° art.: 210-118
Rail acier; 35 x 15; épaisseur 2,3 mm; longueur 2 m; non perforé; d'après EN 60715 www.wago.com/210-118

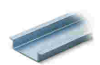

N° art.: 210-196
Rail aluminium; 35 x 8,2; épaisseur 1,6 mm; longueur 2 m; non perforé; d'après EN 60715 www.wago.com/210-196



N° art.: 210-197
Rail acier; 35 x 15; épaisseur 1,5 mm; longueur 2 m; perforé; d'après EN 60715 www.wago.com/210-197



N° art.: 210-198
Rail en cuivre; 35 x 15; épaisseur 2,3 mm; longueur 2 m; non perforé; d'après EN 60715 www.wago.com/210-198



N° art.: 210-504
Rail acier; 35 x 7,5; épaisseur 1 mm; longueur 2 m; perforé; galvanisation de bandes; d'après EN 60715 www.wago.com/210-504

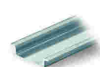

N° art.: 210-505
Rail acier; 35 x 7,5; épaisseur 1 mm; longueur 2 m; non perforé; galvanisation de bandes; d'après EN 60715 www.wago.com/210-505



N° art.: 210-506
Rail acier; 35 x 15; épaisseur 1,5 mm; longueur 2 m; non perforé; galvanisation de bandes; d'après EN 60715 www.wago.com/210-506





N° art.: 210-508
Rail acier; 35 x 15; épaisseur 1,5 mm; longueur 2 m; perforé; galvanisation de bandes; d'après EN 60715 www.wago.com/210-508

ferrule

	N° art.: 216-101 Embout d'extrémité; embout pour 0,5 mm ² / AWG 22; sans isolation plastique; étamés par électrolyse	www.wago.com/216-101
	N° art.: 216-102 Embout d'extrémité; embout pour 0,75 mm ² / AWG 20; sans isolation plastique; étamés par électrolyse	www.wago.com/216-102
	N° art.: 216-103 Embout d'extrémité; embout pour 1 mm ² / AWG 18; sans isolation plastique; étamés par électrolyse	www.wago.com/216-103
	N° art.: 216-104 Embout d'extrémité; embout pour 1,5 mm ² / AWG 16; sans isolation plastique; étamés par électrolyse	www.wago.com/216-104
	N° art.: 216-201 Embout d'extrémité; embout pour 0,5 mm ² / AWG 22; avec isolation plastique; étamés par électrolyse	www.wago.com/216-201
	N° art.: 216-202 Embout d'extrémité; embout pour 0,75 mm ² / AWG 20; avec isolation plastique; étamés par électrolyse	www.wago.com/216-202
	N° art.: 216-203 Embout d'extrémité; embout pour 1 mm ² / AWG 18; avec isolation plastique; étamés par électrolyse	www.wago.com/216-203
	N° art.: 216-204 Embout d'extrémité; embout pour 1,5 mm ² / AWG 16; avec isolation plastique; étamés par électrolyse	www.wago.com/216-204
	N° art.: 216-301 Embout d'extrémité; embout pour 0,25 mm ² / AWG 24; avec isolation plastique; étamés par électrolyse	www.wago.com/216-301
	N° art.: 216-302 Embout d'extrémité; embout pour 0,34 mm ² / AWG 24; avec isolation plastique; étamés par électrolyse	www.wago.com/216-302



Insulation stop

	N° art.: 280-470 Réducteur isolant de sécurité; 0,08 - 0,2 mm ² « r » (0,14 mm ² « s »); 5 pièces/bande	www.wago.com/280-470
	N° art.: 280-471 Réducteur isolant de sécurité; 0,25 - 0,5 mm ² ; 5 pièces/bande	www.wago.com/280-471
	N° art.: 280-472 Réducteur isolant de sécurité; 0,75 - 1 mm ² ; 5 pièces/bande	www.wago.com/280-472















Protective Warning Marker















	N° art.: 280-415 Obturateur de protection avec signalisation de danger; avec signalisation de danger; pour 5 bornes	www.wago.com/280-415
--	---	--















assembling

	N° art.: 209-106 Pied de montage; pour le montage isolé des rails DIN35	www.wago.com/209-106
	N° art.: 709-153 Profil de recouvrement; typ. 1; approprié au support pour capot type 1; longueur 1 m	www.wago.com/709-153











Female plug















	N° art.: 232-132/005-000 Female connector for rail-mount terminal blocks; Droit; Pas 5 mm; 2 pôles	www.wago.com/232-132/005-000
	N° art.: 232-132/005-000/039-000 Female connector for rail-mount terminal blocks; Droit; Cliquets de verrouillage; Pas 5 mm; 3 pôles	www.wago.com/232-132/005-000/039-000
	N° art.: 232-133/005-000 Female connector for rail-mount terminal blocks; Droit; Pas 5 mm; 3 pôles	www.wago.com/232-133/005-000
	N° art.: 232-133/005-000/039-000 Female connector for rail-mount terminal blocks; Droit; Cliquets de verrouillage; Pas 5 mm; 3 pôles	www.wago.com/232-133/005-000/039-000
	N° art.: 232-134/005-000 Female connector for rail-mount terminal blocks; Droit; Pas 5 mm; 4 pôles	www.wago.com/232-134/005-000
	N° art.: 232-134/005-000/039-000 Female connector for rail-mount terminal blocks; Droit; Cliquets de verrouillage; Pas 5 mm; 4 pôles	www.wago.com/232-134/005-000/039-000
	N° art.: 232-135/005-000 Female connector for rail-mount terminal blocks; Droit; Pas 5 mm; 5 pôles	www.wago.com/232-135/005-000
	N° art.: 232-135/005-000/039-000 Female connector for rail-mount terminal blocks; Droit; Cliquets de verrouillage; Pas 5 mm; 5 pôles	www.wago.com/232-135/005-000/039-000
	N° art.: 232-136/005-000 Female connector for rail-mount terminal blocks; Droit; Pas 5 mm; 6 pôles	www.wago.com/232-136/005-000
	N° art.: 232-136/005-000/039-000 Female connector for rail-mount terminal blocks; Droit; Cliquets de verrouillage; Pas 5 mm; 6 pôles	www.wago.com/232-136/005-000/039-000
	N° art.: 232-137/005-000 Female connector for rail-mount terminal blocks; Droit; Pas 5 mm; 7 pôles	www.wago.com/232-137/005-000
	N° art.: 232-137/005-000/039-000 Female connector for rail-mount terminal blocks; Droit; Cliquets de verrouillage; Pas 5 mm; 7 pôles	www.wago.com/232-137/005-000/039-000
	N° art.: 232-138/005-000 Female connector for rail-mount terminal blocks; Droit; Pas 5 mm; 8 pôles	www.wago.com/232-138/005-000
	N° art.: 232-138/005-000/039-000 Female connector for rail-mount terminal blocks; Droit; Cliquets de verrouillage; Pas 5 mm; 8 pôles	www.wago.com/232-138/005-000/039-000
	N° art.: 232-139/005-000 Female connector for rail-mount terminal blocks; Droit; Pas 5 mm; 9 pôles	www.wago.com/232-139/005-000

	N° art.: 232-139/005-000/039-000 Female connector for rail-mount terminal blocks; Droit; Cliquets de verrouillage; Pas 5 mm; 9 pôles	www.wago.com/232-139/005-000/039-000
	N° art.: 232-140/005-000 Female connector for rail-mount terminal blocks; Droit; Pas 5 mm; 10 pôles	www.wago.com/232-140/005-000
	N° art.: 232-140/005-000/039-000 Female connector for rail-mount terminal blocks; Droit; Cliquets de verrouillage; Pas 5 mm; 10 pôles	www.wago.com/232-140/005-000/039-000
	N° art.: 232-142/005-000 Female connector for rail-mount terminal blocks; Droit; Pas 5 mm; 12 pôles	www.wago.com/232-142/005-000
	N° art.: 232-142/005-000/039-000 Female connector for rail-mount terminal blocks; Droit; Cliquets de verrouillage; Pas 5 mm; 12 pôles	www.wago.com/232-142/005-000/039-000
	N° art.: 232-146/005-000 Female connector for rail-mount terminal blocks; Droit; Pas 5 mm; 16 pôles	www.wago.com/232-146/005-000
	N° art.: 232-146/005-000/039-000 Female connector for rail-mount terminal blocks; Droit; Cliquets de verrouillage; Pas 5 mm; 16 pôles	www.wago.com/232-146/005-000/039-000
	N° art.: 232-147/005-000/039-000 Female connector for rail-mount terminal blocks; Droit; Cliquets de verrouillage; Pas 5 mm; 17 pôles	www.wago.com/232-147/005-000/039-000
	N° art.: 232-150/005-000 Female connector for rail-mount terminal blocks; Droit; Pas 5 mm; 20 pôles	www.wago.com/232-150/005-000
	N° art.: 232-150/005-000/039-000 Female connector for rail-mount terminal blocks; Droit; Cliquets de verrouillage; Pas 5 mm; 20 pôles	www.wago.com/232-150/005-000/039-000
	N° art.: 232-232/005-000 Female connector for rail-mount terminal blocks; Coudé; Pas 5 mm; 2 pôles	www.wago.com/232-232/005-000
	N° art.: 232-232/005-000/039-000 Female connector for rail-mount terminal blocks; Coudé; Cliquets de verrouillage; Pas 5 mm; 2 pôles	www.wago.com/232-232/005-000/039-000
	N° art.: 232-233/005-000 Female connector for rail-mount terminal blocks; Coudé; Pas 5 mm; 3 pôles	www.wago.com/232-233/005-000
	N° art.: 232-233/005-000/039-000 Female connector for rail-mount terminal blocks; Coudé; Cliquets de verrouillage; Pas 5 mm; 3 pôles	www.wago.com/232-233/005-000/039-000















	N° art.: 232-234/005-000 Female connector for rail-mount terminal blocks; Coudé; Pas 5 mm; 4 pôles	www.wago.com/232-234/005-000
	N° art.: 232-234/005-000/039-000 Female connector for rail-mount terminal blocks; Coudé; Cliquets de verrouillage; Pas 5 mm; 4 pôles	www.wago.com/232-234/005-000/039-000
	N° art.: 232-235/005-000 Female connector for rail-mount terminal blocks; Coudé; Pas 5 mm; 5 pôles	www.wago.com/232-235/005-000
	N° art.: 232-235/005-000/039-000 Female connector for rail-mount terminal blocks; Coudé; Cliquets de verrouillage; Pas 5 mm; 5 pôles	www.wago.com/232-235/005-000/039-000
	N° art.: 232-236/005-000 Female connector for rail-mount terminal blocks; Coudé; Pas 5 mm; 6 pôles	www.wago.com/232-236/005-000
	N° art.: 232-236/005-000/039-000 Female connector for rail-mount terminal blocks; Coudé; Cliquets de verrouillage; Pas 5 mm; 6 pôles	www.wago.com/232-236/005-000/039-000
	N° art.: 232-237/005-000 Female connector for rail-mount terminal blocks; Coudé; Pas 5 mm; 7 pôles	www.wago.com/232-237/005-000
	N° art.: 232-238/005-000 Female connector for rail-mount terminal blocks; Coudé; Pas 5 mm; 8 pôles	www.wago.com/232-238/005-000
	N° art.: 232-239/005-000 Female connector for rail-mount terminal blocks; Coudé; Pas 5 mm; 9 pôles	www.wago.com/232-239/005-000
	N° art.: 232-240/005-000 Female connector for rail-mount terminal blocks; Coudé; Pas 5 mm; 10 pôles	www.wago.com/232-240/005-000
	N° art.: 232-240/005-000/039-000 Female connector for rail-mount terminal blocks; Coudé; Cliquets de verrouillage; Pas 5 mm; 10 pôles	www.wago.com/232-240/005-000/039-000
	N° art.: 232-242/005-000 Female connector for rail-mount terminal blocks; Coudé; Pas 5 mm; 12 pôles	www.wago.com/232-242/005-000
	N° art.: 232-242/005-000/039-000 Female connector for rail-mount terminal blocks; Coudé; Cliquets de verrouillage; Pas 5 mm; 12 pôles	www.wago.com/232-242/005-000/039-000
	N° art.: 232-246/005-000 Female connector for rail-mount terminal blocks; Coudé; Pas 5 mm; 16 pôles	www.wago.com/232-246/005-000
	N° art.: 232-246/005-000/039-000 Female connector for rail-mount terminal blocks; Coudé; Cliquets de verrouillage; Pas 5 mm; 16 pôles	www.wago.com/232-246/005-000/039-000































	N° art.: 232-250/005-000 Female connector for rail-mount terminal blocks; Coudé; Pas 5 mm; 20 pôles	www.wago.com/232-250/005-000
	N° art.: 232-250/005-000/039-000 Female connector for rail-mount terminal blocks; Coudé; Cliquets de verrouillage; Pas 5 mm; 20 pôles	www.wago.com/232-250/005-000/039-000
	N° art.: 232-732/005-000 Female connector for rail-mount terminal blocks; Droit; Pas 7,5 mm; 2 pôles	www.wago.com/232-732/005-000
	N° art.: 232-733/005-000 Female connector for rail-mount terminal blocks; Droit; Pas 7,5 mm; 3 pôles	www.wago.com/232-733/005-000
	N° art.: 232-734/005-000 Female connector for rail-mount terminal blocks; Droit; Pas 7,5 mm; 4 pôles	www.wago.com/232-734/005-000
	N° art.: 232-734/005-000/039-000 Female connector for rail-mount terminal blocks; Droit; Pas 7,5 mm; 4 pôles	www.wago.com/232-734/005-000/039-000
	N° art.: 232-735/005-000 Female connector for rail-mount terminal blocks; Droit; Pas 7,5 mm; 5 pôles	www.wago.com/232-735/005-000
	N° art.: 232-735/005-000/039-000 Female connector for rail-mount terminal blocks; Droit; Pas 7,5 mm; 5 pôles	www.wago.com/232-735/005-000/039-000
	N° art.: 232-736/005-000 Female connector for rail-mount terminal blocks; Droit; Pas 7,5 mm; 6 pôles	www.wago.com/232-736/005-000
	N° art.: 232-736/005-000/039-000 Female connector for rail-mount terminal blocks; Droit; Pas 7,5 mm; 6 pôles	www.wago.com/232-736/005-000/039-000
	N° art.: 232-738/005-000 Female connector for rail-mount terminal blocks; Droit; Pas 7,5 mm; 8 pôles	www.wago.com/232-738/005-000
	N° art.: 232-740/005-000 Female connector for rail-mount terminal blocks; Droit; Pas 7,5 mm; 10 pôles	www.wago.com/232-740/005-000
	N° art.: 232-742/005-000 Female connector for rail-mount terminal blocks; Droit; Pas 7,5 mm; 12 pôles	www.wago.com/232-742/005-000
	N° art.: 232-832/005-000 Female connector for rail-mount terminal blocks; Coudé; Pas 7,5 mm; 2 pôles	www.wago.com/232-832/005-000

	N° art.: 232-833/005-000 Female connector for rail-mount terminal blocks; Coudé; Pas 7,5 mm; 3 pôles	www.wago.com/232-833/005-000
	N° art.: 232-834/005-000 Female connector for rail-mount terminal blocks; Coudé; Pas 7,5 mm; 4 pôles	www.wago.com/232-834/005-000
	N° art.: 232-836/005-000 Female connector for rail-mount terminal blocks; Coudé; Pas 7,5 mm; 6 pôles	www.wago.com/232-836/005-000
	N° art.: 232-836/005-000/039-000 Female connector for rail-mount terminal blocks; Coudé; Pas 7,5 mm; 6 pôles	www.wago.com/232-836/005-000/039-000
	N° art.: 232-840/005-000 Female connector for rail-mount terminal blocks; Coudé; Pas 7,5 mm; 10 pôles	www.wago.com/232-840/005-000
	N° art.: 232-842/005-000 Female connector for rail-mount terminal blocks; Coudé; Pas 7,5 mm; 12 pôles	www.wago.com/232-842/005-000
	N° art.: 722-132/005-000 Female connector for rail-mount terminal blocks; Droit; 100% protégé contre l'inversion; Pas 5 mm; 2 pôles	www.wago.com/722-132/005-000
	N° art.: 722-132/005-000/039-000 Female connector for rail-mount terminal blocks; Droit; 100% protégé contre l'inversion; Cliquets de verrouillage; Pas 5 mm; 3 pôles	www.wago.com/722-132/005-000/039-000
	N° art.: 722-133/005-000 Female connector for rail-mount terminal blocks; Droit; 100% protégé contre l'inversion; Pas 5 mm; 3 pôles	www.wago.com/722-133/005-000
	N° art.: 722-133/005-000/039-000 Female connector for rail-mount terminal blocks; Droit; 100% protégé contre l'inversion; Cliquets de verrouillage; Pas 5 mm; 3 pôles	www.wago.com/722-133/005-000/039-000
	N° art.: 722-134/005-000 Female connector for rail-mount terminal blocks; Droit; 100% protégé contre l'inversion; Pas 5 mm; 4 pôles	www.wago.com/722-134/005-000
	N° art.: 722-134/005-000/039-000 Female connector for rail-mount terminal blocks; Droit; 100% protégé contre l'inversion; Cliquets de verrouillage; Pas 5 mm; 4 pôles	www.wago.com/722-134/005-000/039-000
	N° art.: 722-135/005-000 Female connector for rail-mount terminal blocks; Droit; 100% protégé contre l'inversion; Pas 5 mm; 5 pôles	www.wago.com/722-135/005-000
	N° art.: 722-135/005-000/039-000 Female connector for rail-mount terminal blocks; Droit; 100% protégé contre l'inversion; Cliquets de verrouillage; Pas 5 mm; 5 pôles	www.wago.com/722-135/005-000/039-000
	N° art.: 722-136/005-000 Female connector for rail-mount terminal blocks; Droit; 100% protégé contre l'inversion; Pas 5 mm; 6 pôles	www.wago.com/722-136/005-000



pôles

	N° art.: 722-136/005-000/039-000 Female connector for rail-mount terminal blocks; Droit; 100% protégé contre l'inversion; Cliquets de verrouillage; Pas 5 mm; 6 pôles	www.wago.com/722-136/005-000/039-000
	N° art.: 722-137/005-000 Female connector for rail-mount terminal blocks; Droit; 100% protégé contre l'inversion; Pas 5 mm; 7 pôles	www.wago.com/722-137/005-000
	N° art.: 722-137/005-000/039-000 Female connector for rail-mount terminal blocks; Droit; 100% protégé contre l'inversion; Cliquets de verrouillage; Pas 5 mm; 7 pôles	www.wago.com/722-137/005-000/039-000
	N° art.: 722-138/005-000 Female connector for rail-mount terminal blocks; Droit; 100% protégé contre l'inversion; Pas 5 mm; 8 pôles	www.wago.com/722-138/005-000
	N° art.: 722-138/005-000/039-000 Female connector for rail-mount terminal blocks; Droit; 100% protégé contre l'inversion; Cliquets de verrouillage; Pas 5 mm; 8 pôles	www.wago.com/722-138/005-000/039-000
	N° art.: 722-139/005-000 Female connector for rail-mount terminal blocks; Droit; 100% protégé contre l'inversion; Pas 5 mm; 9 pôles	www.wago.com/722-139/005-000
	N° art.: 722-139/005-000/039-000 Female connector for rail-mount terminal blocks; Droit; 100% protégé contre l'inversion; Cliquets de verrouillage; Pas 5 mm; 9 pôles	www.wago.com/722-139/005-000/039-000
	N° art.: 722-140/005-000 Female connector for rail-mount terminal blocks; Droit; 100% protégé contre l'inversion; Pas 5 mm; 10 pôles	www.wago.com/722-140/005-000
	N° art.: 722-140/005-000/039-000 Female connector for rail-mount terminal blocks; Droit; 100% protégé contre l'inversion; Cliquets de verrouillage; Pas 5 mm; 10 pôles	www.wago.com/722-140/005-000/039-000
	N° art.: 722-141/005-000 Female connector for rail-mount terminal blocks; Droit; 100% protégé contre l'inversion; Pas 5 mm; 11 pôles	www.wago.com/722-141/005-000
	N° art.: 722-142/005-000 Female connector for rail-mount terminal blocks; Droit; 100% protégé contre l'inversion; Pas 5 mm; 12 pôles	www.wago.com/722-142/005-000
	N° art.: 722-142/005-007/039-000 Female connector for rail-mount terminal blocks; Droit; 100% protégé contre l'inversion; Cliquets de verrouillage; Pas 5 mm; 12 pôles	www.wago.com/722-142/005-007/039-000
	N° art.: 722-143/005-000 Female connector for rail-mount terminal blocks; Droit; 100% protégé contre l'inversion; Pas 5 mm; 13 pôles	www.wago.com/722-143/005-000
	N° art.: 722-144/005-000 Female connector for rail-mount terminal blocks; Droit; 100% protégé contre l'inversion; Pas 5 mm; 14 pôles	www.wago.com/722-144/005-000
	N° art.: 722-144/005-000/039-000	











	Female connector for rail-mount terminal blocks; Droit; 100% protégé contre l'inversion; Cliquets de verrouillage; Pas 5 mm; 14 pôles	www.wago.com/722-144/005-000/039-000
	N° art.: 722-145/005-000 Female connector for rail-mount terminal blocks; Droit; 100% protégé contre l'inversion; Pas 5 mm; 15 pôles	www.wago.com/722-145/005-000
	N° art.: 722-146/005-000 Female connector for rail-mount terminal blocks; Droit; 100% protégé contre l'inversion; Pas 5 mm; 16 pôles	www.wago.com/722-146/005-000
	N° art.: 722-146/005-000/039-000 Female connector for rail-mount terminal blocks; Droit; 100% protégé contre l'inversion; Cliquets de verrouillage; Pas 5 mm; 16 pôles	www.wago.com/722-146/005-000/039-000
	N° art.: 722-150/005-000 Female connector for rail-mount terminal blocks; Droit; 100% protégé contre l'inversion; Pas 5 mm; 20 pôles	www.wago.com/722-150/005-000
	N° art.: 722-150/005-000/039-000 Female connector for rail-mount terminal blocks; Droit; 100% protégé contre l'inversion; Cliquets de verrouillage; Pas 5 mm; 20 pôles	www.wago.com/722-150/005-000/039-000
	N° art.: 722-232/005-000 Female connector for rail-mount terminal blocks; Coudé; 100% protégé contre l'inversion; Pas 5 mm; 3 pôles	www.wago.com/722-232/005-000
	N° art.: 722-232/005-000/039-000 Female connector for rail-mount terminal blocks; Coudé; 100% protégé contre l'inversion; Cliquets de verrouillage; Pas 5 mm; 3 pôles	www.wago.com/722-232/005-000/039-000
	N° art.: 722-233/005-000 Female connector for rail-mount terminal blocks; Coudé; 100% protégé contre l'inversion; Pas 5 mm; 3 pôles	www.wago.com/722-233/005-000
	N° art.: 722-233/005-000/039-000 Female connector for rail-mount terminal blocks; Coudé; 100% protégé contre l'inversion; Cliquets de verrouillage; Pas 5 mm; 3 pôles	www.wago.com/722-233/005-000/039-000
	N° art.: 722-234/005-000 Female connector for rail-mount terminal blocks; Coudé; 100% protégé contre l'inversion; Pas 5 mm; 4 pôles	www.wago.com/722-234/005-000
	N° art.: 722-234/005-000/039-000 Female connector for rail-mount terminal blocks; Coudé; 100% protégé contre l'inversion; Cliquets de verrouillage; Pas 5 mm; 4 pôles	www.wago.com/722-234/005-000/039-000
	N° art.: 722-235/005-000 Female connector for rail-mount terminal blocks; Coudé; 100% protégé contre l'inversion; Pas 5 mm; 5 pôles	www.wago.com/722-235/005-000
	N° art.: 722-235/005-000/039-000 Female connector for rail-mount terminal blocks; Coudé; 100% protégé contre l'inversion; Cliquets de verrouillage; Pas 5 mm; 5 pôles	www.wago.com/722-235/005-000/039-000
	N° art.: 722-236/005-000 Female connector for rail-mount terminal blocks; Coudé; 100% protégé contre l'inversion; Pas 5 mm; 6 pôles	www.wago.com/722-236/005-000



















	N° art.: 722-236/005-000/039-000 Female connector for rail-mount terminal blocks; Coudé; 100% protégé contre l'inversion; Cliquets de verrouillage; Pas 5 mm; 6 pôles	www.wago.com/722-236/005-000/039-000
	N° art.: 722-237/005-000 Female connector for rail-mount terminal blocks; Coudé; 100% protégé contre l'inversion; Pas 5 mm; 7 pôles	www.wago.com/722-237/005-000
	N° art.: 722-237/005-000/039-000 Female connector for rail-mount terminal blocks; Coudé; 100% protégé contre l'inversion; Cliquets de verrouillage; Pas 5 mm; 7 pôles	www.wago.com/722-237/005-000/039-000
	N° art.: 722-238/005-000 Female connector for rail-mount terminal blocks; Coudé; 100% protégé contre l'inversion; Pas 5 mm; 8 pôles	www.wago.com/722-238/005-000
	N° art.: 722-239/005-000 Female connector for rail-mount terminal blocks; Coudé; 100% protégé contre l'inversion; Pas 5 mm; 9 pôles	www.wago.com/722-239/005-000
	N° art.: 722-239/005-000/039-000 Female connector for rail-mount terminal blocks; Coudé; 100% protégé contre l'inversion; Cliquets de verrouillage; Pas 5 mm; 9 pôles	www.wago.com/722-239/005-000/039-000
	N° art.: 722-240/005-000 Female connector for rail-mount terminal blocks; Coudé; 100% protégé contre l'inversion; Pas 5 mm; 10 pôles	www.wago.com/722-240/005-000
	N° art.: 722-240/005-000/039-000 Female connector for rail-mount terminal blocks; Coudé; 100% protégé contre l'inversion; Cliquets de verrouillage; Pas 5 mm; 10 pôles	www.wago.com/722-240/005-000/039-000
	N° art.: 722-241/005-000 Female connector for rail-mount terminal blocks; Coudé; 100% protégé contre l'inversion; Pas 5 mm; 11 pôles	www.wago.com/722-241/005-000
	N° art.: 722-242/005-000 Female connector for rail-mount terminal blocks; Coudé; 100% protégé contre l'inversion; Pas 5 mm; 12 pôles	www.wago.com/722-242/005-000
	N° art.: 722-242/005-000/039-000 Female connector for rail-mount terminal blocks; Coudé; 100% protégé contre l'inversion; Cliquets de verrouillage; Pas 5 mm; 12 pôles	www.wago.com/722-242/005-000/039-000
	N° art.: 722-243/005-000 Female connector for rail-mount terminal blocks; Coudé; 100% protégé contre l'inversion; Pas 5 mm; 13 pôles	www.wago.com/722-243/005-000
	N° art.: 722-244/005-000 Female connector for rail-mount terminal blocks; Coudé; 100% protégé contre l'inversion; Pas 5 mm; 14 pôles	www.wago.com/722-244/005-000
	N° art.: 722-244/005-000/039-000 Female connector for rail-mount terminal blocks; Coudé; 100% protégé contre l'inversion; Cliquets de verrouillage; Pas 5 mm; 14 pôles	www.wago.com/722-244/005-000/039-000



















N° art.: 722-246/005-000

	Female connector for rail-mount terminal blocks; Coudé; 100% protégé contre l'inversion; Pas 5 mm; 16 pôles	www.wago.com/722-246/005-000
	N° art.: 722-246/005-000/039-000 Female connector for rail-mount terminal blocks; Coudé; 100% protégé contre l'inversion; Cliquets de verrouillage; Pas 5 mm; 16 pôles	www.wago.com/722-246/005-000/039-000
	N° art.: 722-250/005-000 Female connector for rail-mount terminal blocks; Coudé; 100% protégé contre l'inversion; Pas 5 mm; 20 pôles	www.wago.com/722-250/005-000

General accessories

	N° art.: 231-162/003-000 Male connector for rail-mount terminal blocks; 1.2 x 1.2 mm pins; Droit; Pas 5 mm; 2 pôles	www.wago.com/231-162/003-000
	N° art.: 231-163/003-000 Male connector for rail-mount terminal blocks; 1.2 x 1.2 mm pins; Droit; Pas 5 mm; 3 pôles	www.wago.com/231-163/003-000
	N° art.: 231-164/003-000 Male connector for rail-mount terminal blocks; 1.2 x 1.2 mm pins; Droit; Pas 5 mm; 4 pôles	www.wago.com/231-164/003-000
	N° art.: 231-165/003-000 Male connector for rail-mount terminal blocks; 1.2 x 1.2 mm pins; Droit; Pas 5 mm; 5 pôles	www.wago.com/231-165/003-000
	N° art.: 231-166/003-000 Male connector for rail-mount terminal blocks; 1.2 x 1.2 mm pins; Droit; Pas 5 mm; 6 pôles	www.wago.com/231-166/003-000
	N° art.: 231-167/003-000 Male connector for rail-mount terminal blocks; 1.2 x 1.2 mm pins; Droit; Pas 5 mm; 7 pôles	www.wago.com/231-167/003-000
	N° art.: 231-168/003-000 Male connector for rail-mount terminal blocks; 1.2 x 1.2 mm pins; Droit; Pas 5 mm; 8 pôles	www.wago.com/231-168/003-000
	N° art.: 231-169/003-000 Male connector for rail-mount terminal blocks; 1.2 x 1.2 mm pins; Droit; Pas 5 mm; 9 pôles	www.wago.com/231-169/003-000
	N° art.: 231-170/003-000 Male connector for rail-mount terminal blocks; 1.2 x 1.2 mm pins; Droit; Pas 5 mm; 10 pôles	www.wago.com/231-170/003-000
	N° art.: 231-171/003-000 Male connector for rail-mount terminal blocks; 1.2 x 1.2 mm pins; Droit; Pas 5 mm; 11 pôles	www.wago.com/231-171/003-000
	N° art.: 231-172/003-000 Male connector for rail-mount terminal blocks; 1.2 x 1.2 mm pins; Droit; Pas 5 mm; 12 pôles	www.wago.com/231-172/003-000

	N° art.: 231-176/003-000 Male connector for rail-mount terminal blocks; 1.2 x 1.2 mm pins; Droit; Pas 5 mm; 16 pôles	www.wago.com/231-176/003-000
	N° art.: 231-180/003-000 Male connector for rail-mount terminal blocks; 1.2 x 1.2 mm pins; Droit; Pas 5 mm; 20 pôles	www.wago.com/231-180/003-000
	N° art.: 280-404 Adaptateur de test; Largeur 5 mm; pour fiche de test 210-137 (Ø 2,3 mm); approprié pour des bornes d'une section de 1,5 mm ² - 4 mm ²	www.wago.com/280-404
	N° art.: 280-418 Module fiche de contrôle; modulaires; approprié à toutes les bornes sur rail des séries 280 et 780 avec fentes de pontage	www.wago.com/280-418
	N° art.: 280-419 Module vide; modulaires; pour sauter des bornes	www.wago.com/280-419
Jumper		
	N° art.: 210-103 Chaîne de pontage en fil; isolé; 50 raccords	www.wago.com/210-103
	N° art.: 210-123 Chaîne de pontage en fil; isolé; 50 raccords	www.wago.com/210-123
	N° art.: 249-123 Conducteurs de pontage enfichables; isolé; L = 180 mm; Section du conducteur 0,75 mm ²	www.wago.com/249-123
	N° art.: 249-125 Conducteurs de pontage enfichables; isolé; L = 60 mm; Section du conducteur 0,75 mm ²	www.wago.com/249-125
	N° art.: 249-126 Conducteurs de pontage enfichables; isolé; L = 110 mm; Section du conducteur 0,75 mm ²	www.wago.com/249-126
	N° art.: 249-127 Conducteurs de pontage enfichables; isolé; L = 250 mm; Section du conducteur 0,75 mm ²	www.wago.com/249-127
	N° art.: 280-402 Contact de pontage horizontal; isolé; IN = IN borne	www.wago.com/280-402
	N° art.: 280-409 Contact de pontage alternatif; isolé; IN = IN borne	www.wago.com/280-409
	N° art.: 280-422 Contact de pontage horizontal; isolé; IN = IN borne	www.wago.com/280-422
	N° art.: 280-482 Peigne de pontage; isolé; 2 raccords; IN = IN borne	www.wago.com/280-482
	N° art.: 280-483 Peigne de pontage; isolé; 3 raccords; IN = IN borne	www.wago.com/280-483
	N° art.: 280-484 Peigne de pontage; isolé; 4 raccords; IN = IN borne	www.wago.com/280-484
	N° art.: 280-485 Peigne de pontage; isolé; 5 raccords; IN = IN borne	www.wago.com/280-485

	N° art.: 280-490 Peigne de pontage; isolé; 10 raccords; IN = IN borne	www.wago.com/280-490
	N° art.: 280-492 Peigne de pontage alternant; isolé; 2 raccords; IN = IN borne	www.wago.com/280-492
	N° art.: 709-110 Chaîne de pontage en fil; isolé; 4 raccords; 3 x 110	www.wago.com/709-110
	N° art.: 709-111 Chaîne de pontage en fil; isolé; 3 raccords; 2 x 120	www.wago.com/709-111
	N° art.: 709-112 Chaîne de pontage en fil; isolé; 3 raccords; 2 x 170	www.wago.com/709-112
	N° art.: 780-452 Ponts intercalables; isolé; de 1 à 2; Pas 5 mm; approprié pour connecteurs femelles pour 2 conducteurs	www.wago.com/780-452
	N° art.: 780-453 Ponts intercalables; isolé; de 1 à 3; Pas 5 mm; approprié pour connecteurs femelles pour 2 conducteurs	www.wago.com/780-453
	N° art.: 780-454 Ponts intercalables; isolé; de 1 à 4; Pas 5 mm; approprié pour connecteurs femelles pour 2 conducteurs	www.wago.com/780-454
	N° art.: 780-455 Ponts intercalables; isolé; de 1 à 5; Pas 5 mm; approprié pour connecteurs femelles pour 2 conducteurs	www.wago.com/780-455
	N° art.: 780-456 Ponts intercalables; isolé; de 1 à 6; Pas 5 mm; approprié pour connecteurs femelles pour 2 conducteurs	www.wago.com/780-456
	N° art.: 780-457 Ponts intercalables; isolé; de 1 à 7; Pas 5 mm; approprié pour connecteurs femelles pour 2 conducteurs	www.wago.com/780-457
	N° art.: 780-458 Ponts intercalables; isolé; de 1 à 8; Pas 5 mm; approprié pour connecteurs femelles pour 2 conducteurs	www.wago.com/780-458
check		
	N° art.: 209-170 Adaptateur de test; Largeur 8,3 mm; pour fiche de test Ø 4 mm; approprié pour des bornes d'une section de 1,5 mm ² - 10 mm ²	www.wago.com/209-170
	N° art.: 210-136 Fiche de contrôle; Ø 2 mm; avec câble de longueur 500 mm	www.wago.com/210-136
	N° art.: 210-137 Fiche de contrôle; Ø 2,3 mm; avec câble de longueur 500 mm	www.wago.com/210-137
	N° art.: 249-106 Module de fiche de contrôle type B; modulaires	www.wago.com/249-106
	N° art.: 249-107 Module vide type B; modulaires; pour sauter p.ex. des bornes pontées	www.wago.com/249-107
	N° art.: 249-141 Module de fiche de contrôle type L; modulaires; avec broche de contact à ressort; Module central	www.wago.com/249-141

tools



N° art.: 210-657

Outil de manipulation, partiellement isolé; Lame (3,5 x 0,5) mm; court

www.wago.com/210-657



N° art.: 210-658

Outil de manipulation, partiellement isolé; Lame (3,5 x 0,5) mm; court; Coudé

www.wago.com/210-658



N° art.: 210-720

Outil de manipulation, partiellement isolé; Type 2, lame (3,5 x 0,5) mm

www.wago.com/210-720

Téléchargements

Documentation

Bid Text

280-880

Oct 12, 2017

DOC
25,6 kB

Téléchargement

Sous réserve de modifications.