



## RD24 Steckverbinder RD24 connectors

### Kabelsteckverbinder

- Steckverbinder mit Schraubverriegelung
- Schutzart IP67 <sup>1)</sup>
- Varianten mit VDE-, SEV-, UL-Zulassung
- 3 Anschlusstechniken:
  - **LÖT**anschluss
  - **SCHRAUB**anschluss
  - **CRIMP**anschluss für gedrehte Crimpkontakte (die u.a. auch in schweren Rechtecksteckverbindern nach DIN 43 652 eingesetzt werden)

### Cable Connector

- Connector with screw locking
- Degree of protection IP67 <sup>1)</sup>
- Versions with VDE-, SEV-, UL-approval
- 3 termination possibilities:
  - **SOLDER** termination
  - **SCREW** termination
  - **CRIMP** termination for turned crimp contacts (which are used in heavy duty rectangular connectors DIN 43652)



Aufbau des Steckverbinders:  
Construction of the connector:

Kabelstecker  
Male cable connector

Winkelstecker  
Male angled connector

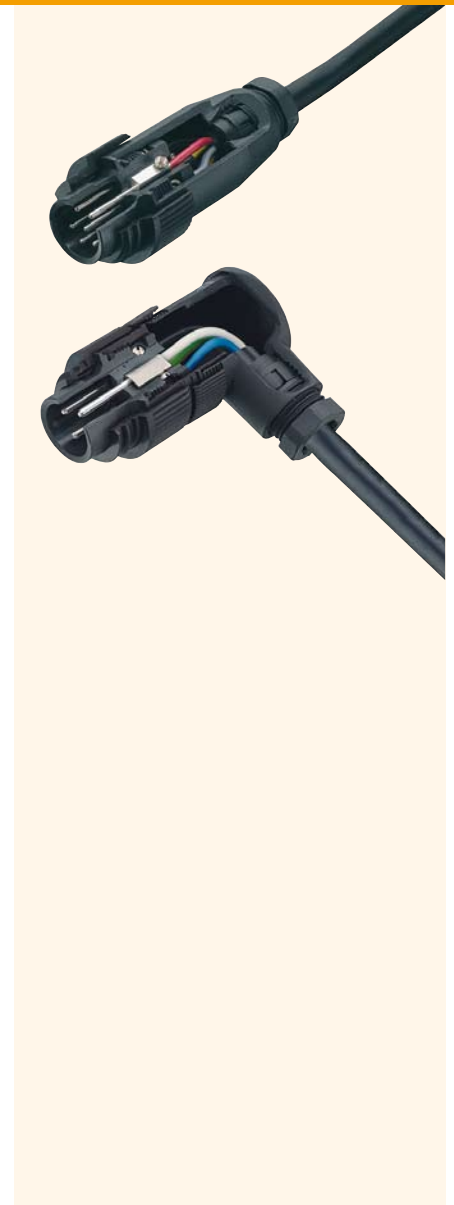

**Leistungs Steckverbinder Serie 692 - 693**  
**Power connectors series 692 - 693**
**Bezeichnung**  
*Description*
**Kabelstecker, PG9**  
*Male cable connector, PG9*
**Kabelstecker, PG9 mit VDE, SEV, UL Zulassung**  
*Male cable connector, PG9 with VDE, SEV, UL approval*
**Abbildung**  
*Figure*
**Crimpkontakte siehe Seite 27.**  
*Crimp contacts see page 27.*
**Crimpkontakte siehe Seite 27.**  
*Crimp contacts see page 27.*

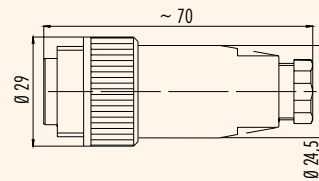
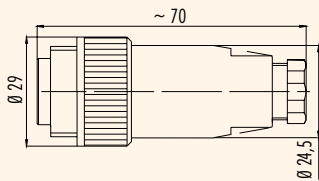
**Maßzeichnung**  
*Drawing*

**Bestell-Nr.**  
*Ordering-No.*

Polzahl Contacts	Anschlussart Termination	Kabeldurchlass (mm) Cable outlet (mm)	Bestell-Nr. Ordering-No.
3+PE	schrauben screw	6-9,5	99-0209-00-04
6+PE	löten solder	6-9,5	99-0213-00-07
6+PE	schrauben screw	6-8	99-0217-00-07
6+PE	crimpen crimp	6-8	99-0201-00-07

Polzahl Contacts	Anschlussart Termination	Kabeldurchlass (mm) Cable outlet (mm)	Bestell-Nr. Ordering-No.
3+PE	schrauben screw	6-9,5	99-4221-00-04
6+PE	löten solder	6-9,5	99-4225-00-07
6+PE	schrauben screw	6-8	99-4217-00-07
6+PE	crimpen crimp	6-8	99-4201-00-07

**Technische Daten**  
*Specifications*

Polzahl	3+PE	6+PE	6+PE	6+PE	Number of contacts
Steckverbinder Verriegelung	schrauben/screw				Connector locking system
Anschlussart	schrauben/screw	löten/solder	schrauben/screw	crimpen/crimp	Termination
Anschlussquerschnitt	0,5-2,5 mm <sup>2</sup> (AWG 20-14)	max. 0,75 mm <sup>2</sup> (max. AWG 18)	0,34-1,5 mm <sup>2</sup> (AWG 22-16)	0,14-1,5 mm <sup>2</sup> (AWG 26-16)	Wire gauge
Kabeldurchlass	6-8 mm, 6-9,5 mm				Cable outlet
Schutzart	IP67 <sup>1)</sup>				Degree of protection
Mechanische Lebensdauer	> 500 Steckzyklen / > 500 mating cycles				Mechanical operation
Obere Grenztemperatur	+ 100 °C				Upper temperature
Untere Grenztemperatur	- 40 °C				Lower temperature
Bemessungsspannung	400 V (600 V UL)		250 V		Rated voltage
Bemessungs-Stoßspannung	6000 V		4000 V		Rated impulse voltage
Verschmutzungsgrad	3				Pollution degree
Überspannungskategorie	III				Overvoltage categorie
Isolierstoffgruppe	III				Material group
Bemessungsstrom (40°C)	16 A (12 A UL)		10 A (8 A UL)		Rated current (40 °C)
Durchgangswiderstand	≤ 5 mΩ				Contact resistance
Material Kontakt	CuZn (Messing/brass)				Material of contact
Kontaktoberfläche	Ag (Silber/silver)				Contact plating
Material Kontaktkörper	PBT (UL 94 V-0)				Material of contact body
Material Gehäuse	PBT (UL 94 V-0)				Material of housing

**Leistungs Steckverbinder Serie 692 - 693**  
**Power connectors series 692 - 693**

Bezeichnung  
Description

Kabelstecker, PG11  
Male cable connector, PG11

Kabelstecker, PG11 mit VDE, SEV, UL Zulassung  
Male cable connector, PG11 with VDE, SEV, UL approval

Abbildung  
Figure

Crimpkontakte siehe Seite 27.  
Crimp contacts see page 27.

Crimpkontakte siehe Seite 27.  
Crimp contacts see page 27.



Maßzeichnung  
Drawing

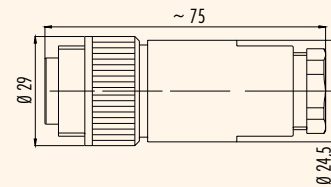
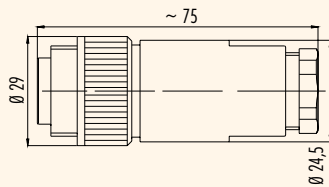

Bestell-Nr.  
Ordering-No.

Polzahl Contacts	Anschlussart Termination	Kabeldurchlass (mm) Cable outlet (mm)	Bestell-Nr. Ordering-No.	Polzahl Contacts	Anschlussart Termination	Kabeldurchlass (mm) Cable outlet (mm)	Bestell-Nr. Ordering-No.
3+PE	schrauben screw	8-10	99-0209-110-04	3+PE	schrauben screw	8-10	99-4221-110-04
6+PE	löten solder	8-10	99-0213-110-07	6+PE	löten solder	8-10	99-4225-110-07
6+PE	schrauben screw	8-10	99-0217-110-07	6+PE	schrauben screw	8-10	99-4217-110-07
6+PE	crimpen crimp	8-10	99-0201-110-07	6+PE	crimpen crimp	8-10	99-4201-110-07

Technische Daten  
Specifications

Polzahl	3+PE	6+PE	6+PE	6+PE	Number of contacts
Steckverbinder Verriegelung	schrauben/screw				Connector locking system
Anschlussart	schrauben/screw	löten/solder	schrauben/screw	crimpen/crimp	Termination
Anschlussquerschnitt	0,5-2,5 mm <sup>2</sup> (AWG 20-14)	max. 0,75 mm <sup>2</sup> (max. AWG 18)	0,34-1,5 mm <sup>2</sup> (AWG 22-16)	0,14-1,5 mm <sup>2</sup> (AWG 26-16)	Wire gauge
Kabeldurchlass	8-10 mm				Cable outlet
Schutzart	IP67				Degree of protection
Mechanische Lebensdauer	> 500 Steckzyklen/> 500 mating cycles				Mechanical operation
Obere Grenztemperatur	+ 100 °C				Upper temperature
Untere Grenztemperatur	- 40 °C				Lower temperature
Bemessungsspannung	400 V (600 V UL)		250 V		Rated voltage
Bemessungs-Stoßspannung	6000 V		4000 V		Rated impulse voltage
Verschmutzungsgrad	3				Pollution degree
Überspannungskategorie	III				Overvoltage categorie
Isolierstoffgruppe	III				Material group
Bemessungsstrom (40°C)	16 A (12 A UL)		10 A (8 A UL)		Rated current (40 °C)
Durchgangswiderstand	≤ 5 mΩ				Contact resistance
Material Kontakt	CuZn (Messing/brass)				Material of contact
Kontaktoberfläche	Ag (Silber/silver)				Contact plating
Material Kontaktkörper	PBT (UL 94 V-0)				Material of contact body
Material Gehäuse	PBT (UL 94 V-0)				Material of housing

## Leistungs Steckverbinder Serie 692 - 693

### Power connectors series 692 - 693

**Bezeichnung**  
*Description*

 Kabelstecker, PG13,5  
*Male cable connector, PG13,5*

 Kabelstecker, PG13,5 mit **VDE, SEV, UL Zulassung**  
*Male cable connector, PG13,5 with VDE, SEV, UL approval*
**Abbildung**  
*Figure*

 Crimpkontakte siehe Seite 27.  
*Crimp contacts see page 27.*

 Crimpkontakte siehe Seite 27.  
*Crimp contacts see page 27.*

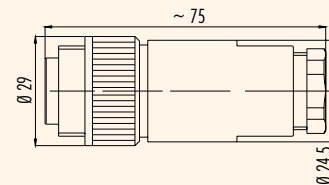
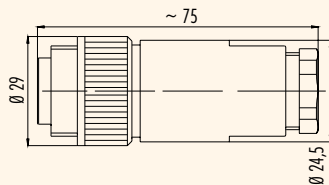
**Maßzeichnung**  
*Drawing*

**Bestell-Nr.**  
*Ordering-No.*

Polzahl Contacts	Anschlussart Termination	Kabeldurchlass (mm) Cable outlet (mm)	Bestell-Nr. Ordering-No.	Polzahl Contacts	Anschlussart Termination	Kabeldurchlass (mm) Cable outlet (mm)	Bestell-Nr. Ordering-No.
3+PE	schrauben screw	10-12	99-0209-15-04	3+PE	schrauben screw	10-12	99-4221-14-04
6+PE	löten solder	10-12	99-0213-15-07	6+PE	löten solder	10-12	99-4225-14-07
6+PE	schrauben screw	10-12	99-0217-15-07	6+PE	schrauben screw	10-12	99-4217-14-07
6+PE	crimpen crimp	10-12	99-0201-15-07	6+PE	crimpen crimp	10-12	99-4201-14-07

**Technische Daten**  
*Specifications*

Polzahl	3+PE	6+PE	6+PE	6+PE	Number of contacts
Steckverbinder Verriegelung	schrauben/screw				Connector locking system
Anschlussart	schrauben/screw	löten/solder	schrauben/screw	crimpen/crimp	Termination
Anschlussquerschnitt	0,5-2,5 mm <sup>2</sup> (AWG 20-14)	max. 0,75 mm <sup>2</sup> (max. AWG 18)	0,34-1,5 mm <sup>2</sup> (AWG 22-16)	0,14-1,5 mm <sup>2</sup> (AWG 26-16)	Wire gauge
Kabeldurchlass	10-12 mm				Cable outlet
Schutzart	IP67				Degree of protection
Mechanische Lebensdauer	> 500 Steckzyklen/> 500 mating cycles				Mechanical operation
Obere Grenztemperatur	+ 100 °C				Upper temperature
Untere Grenztemperatur	- 40 °C				Lower temperature
Bemessungsspannung	400 V (600 V UL)		250 V		Rated voltage
Bemessungs-Stoßspannung	6000 V		4000 V		Rated impulse voltage
Verschmutzungsgrad	3				Pollution degree
Überspannungskategorie	III				Overvoltage categorie
Isolierstoffgruppe	III				Material group
Bemessungsstrom (40°C)	16 A (12 A UL)		10 A (8 A UL)		Rated current (40 °C)
Durchgangswiderstand	≤ 5 mΩ				Contact resistance
Material Kontakt	CuZn (Messing/brass)				Material of contact
Kontaktoberfläche	Ag (Silber/silver)				Contact plating
Material Kontaktkörper	PBT (UL 94 V-0)				Material of contact body
Material Gehäuse	PBT (UL 94 V-0)				Material of housing

**Leistungs Steckverbinder Serie 692 - 693**  
**Power connectors series 692 - 693**
**Bezeichnung**  
*Description*
**Abbildung**  
*Figure*
**Kabelstecker, PG16**  
**Male cable connector, PG16**
**Crimpkontakte siehe Seite 27.**  
**Crimp contacts see page 27.**

**Kabelstecker, PG16 mit VDE, SEV, UL Zulassung**  
**Male cable connector, PG16 with VDE, SEV, UL approval**
**Crimpkontakte siehe Seite 27.**  
**Crimp contacts see page 27.**

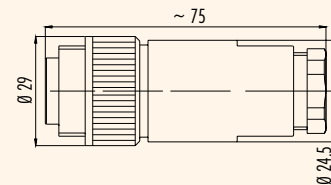
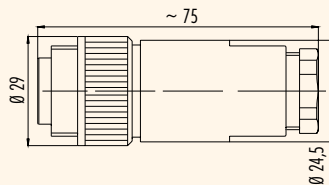
**Maßzeichnung**  
**Drawing**

**Bestell-Nr.**  
**Ordering-No.**

Polzahl Contacts	Anschlussart Termination	Kabeldurchlass (mm) Cable outlet (mm)	Bestell-Nr. Ordering-No.
3+PE	schrauben screw	12-14	99-0209-160-04
6+PE	löten solder	12-14	99-0213-160-07
6+PE	schrauben screw	12-14	99-0217-160-07
6+PE	crimpen crimp	12-14	99-0201-160-07

Polzahl Contacts	Anschlussart Termination	Kabeldurchlass (mm) Cable outlet (mm)	Bestell-Nr. Ordering-No.
3+PE	schrauben screw	12-14	99-4221-160-04
6+PE	löten solder	12-14	99-4225-160-07
6+PE	schrauben screw	12-14	99-4217-160-07
6+PE	crimpen crimp	12-14	99-4201-160-07

**Technische Daten**  
**Specifications**

Polzahl	3+PE	6+PE	6+PE	6+PE	Number of contacts
Steckverbinder Verriegelung	schrauben/screw				Connector locking system
Anschlussart	schrauben/screw	löten/solder	schrauben/screw	crimpen/crimp	Termination
Anschlussquerschnitt	0,5-2,5 mm <sup>2</sup> (AWG 20-14)	max. 0,75 mm <sup>2</sup> (max. AWG 18)	0,34-1,5 mm <sup>2</sup> (AWG 22-16)	0,14-1,5 mm <sup>2</sup> (AWG 26-16)	Wire gauge
Kabeldurchlass	12-14 mm				Cable outlet
Schutzart	IP67				Degree of protection
Mechanische Lebensdauer	> 500 Steckzyklen/> 500 mating cycles				Mechanical operation
Obere Grenztemperatur	+ 100 °C				Upper temperature
Untere Grenztemperatur	- 40 °C				Lower temperature
Bemessungsspannung	400 V (600 V UL)		250 V		Rated voltage
Bemessungsstoßspannung	6000 V		4000 V		Rated impulse voltage
Verschmutzungsgrad	3				Pollution degree
Überspannungskategorie	III				Overvoltage categorie
Isolierstoffgruppe	III				Material group
Bemessungsstrom (40°C)	16 A (12 A UL)		10 A (8 A UL)		Rated current (40 °C)
Durchgangswiderstand	≤ 5 mΩ				Contact resistance
Material Kontakt	CuZn (Messing/brass)				Material of contact
Kontaktoberfläche	Ag (Silber/silver)				Contact plating
Material Kontaktkörper	PBT (UL 94 V-0)				Material of contact body
Material Gehäuse	PBT (UL 94 V-0)				Material of housing

## Leistung Steckverbinder Serie 692 - 693

### Power connectors series 692 - 693

Bezeichnung  
Description

Winkelstecker, PG9  
Male angled connector, PG9

Winkelstecker, PG9 mit VDE, SEV, UL Zulassung  
Male angled connector, PG9 with VDE, SEV, UL approval

Abbildung  
Figure

Crimpkontakte siehe Seite 27.  
Crimp contacts see page 27.

Crimpkontakte siehe Seite 27.  
Crimp contacts see page 27.



Maßzeichnung  
Drawing

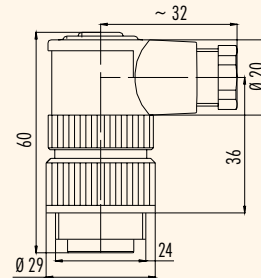
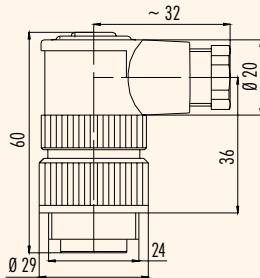

Bestell-Nr.  
Ordering-No.

Polzahl Contacts	Anschlussart Termination	Kabeldurchlass (mm) Cable outlet (mm)	Bestell-Nr. Ordering-No.
3+PE	schrauben screw	6-8	99-0209-70-04
6+PE	löten solder	6-8	99-0213-70-07
6+PE	schrauben screw	6-8	99-0217-70-07
6+PE	crimpen crimp	6-8	99-0201-70-07

Polzahl Contacts	Anschlussart Termination	Kabeldurchlass (mm) Cable outlet (mm)	Bestell-Nr. Ordering-No.
3+PE	schrauben screw	6-8	99-4221-70-04
6+PE	löten solder	6-8	99-4225-70-07
6+PE	schrauben screw	6-8	99-4217-70-07
6+PE	crimpen crimp	6-8	99-4201-70-07

Technische Daten  
Specifications

Polzahl	3+PE	6+PE	6+PE	6+PE	Number of contacts
Steckverbinder Verriegelung	schrauben/screw				Connector locking system
Anschlussart	schrauben/screw	löten/solder	schrauben/screw	crimpen/crimp	Termination
Anschlussquerschnitt	0,5-2,5 mm <sup>2</sup> (AWG 20-14)	max. 0,75 mm <sup>2</sup> (max. AWG 18)	0,34-1,5 mm <sup>2</sup> (AWG 22-16)	0,14-1,5 mm <sup>2</sup> (AWG 26-16)	Wire gauge
Kabeldurchlass	6-8 mm				Cable outlet
Schutzart	IP67 <sup>1)</sup>				Degree of protection
Mechanische Lebensdauer	> 500 Steckzyklen/> 500 mating cycles				Mechanical operation
Obere Grenztemperatur	+ 100 °C				Upper temperature
Untere Grenztemperatur	- 40 °C				Lower temperature
Bemessungsspannung	400 V (600 V UL)		250 V		Rated voltage
Bemessungsstoßspannung	6000 V		4000 V		Rated impulse voltage
Verschmutzungsgrad	3				Pollution degree
Überspannungskategorie	III				Overvoltage categorie
Isolierstoffgruppe	III				Material group
Bemessungsstrom (40°C)	16 A (12 A UL)		10 A (8 A UL)		Rated current (40 °C)
Durchgangswiderstand	≤ 5 mΩ				Contact resistance
Material Kontakt	CuZn (Messing/brass)				Material of contact
Kontaktoberfläche	Ag (Silber/silver)				Contact plating
Material Kontaktkörper	PBT (UL 94 V-0)				Material of contact body
Material Gehäuse	PBT (UL 94 V-0)				Material of housing

**Leistungs Steckverbinder Serie 692 - 693**  
**Power connectors series 692 - 693**
**Bezeichnung**  
*Description*
**Abbildung**  
*Figure*
**Kabelstecker**  
*Male cable connector*

 Technische Kabeldaten siehe Seite 24.  
*Specifications of cable see page 24.*

**Winkelstecker**  
*Male angled connector*

 Technische Kabeldaten siehe Seite 24.  
*Specifications of cable see page 24.*

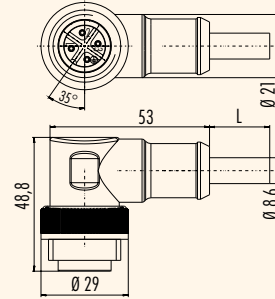
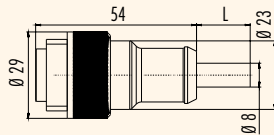
**Maßzeichnung**  
*Drawing*

**Bestell-Nr.**  
*Ordering-No.*

Polzahl Contacts	Kabellänge (m) Cable length (m)	Bestell-Nr. Ordering-No.	Polzahl Contacts	Kabellänge (m) Cable length (m)	Bestell-Nr. Ordering-No.
3+PE 4 x 1,5 PVC	2	79-0231-20-04	3+PE 4 x 1,5 PVC	2	79-0233-20-04
6+PE 7 x 0,75 PVC		79-0235-20-07	6+PE 7 x 0,75 PVC		79-0237-20-07

**Technische Daten**  
*Specifications*

Polzahl	3+PE	6+PE	Number of contacts
Steckverbinder Verriegelung	schrauben/screw		Connector locking system
Anschlussart	crimpen, am Kabel angespritzt/crimp, moulded		Termination
Anschlussquerschnitt	1,5 mm <sup>2</sup> (AWG 16)	0,75 mm <sup>2</sup> (AWG 18)	Wire gauge
Kabeldurchlass	-		Cable outlet
Schutzart	IP67		Degree of protection
Mechanische Lebensdauer	> 500 Steckzyklen/> 500 mating cycles		Mechanical operation
Obere Grenztemperatur	+ 80 °C		Upper temperature
Untere Grenztemperatur	- 25 °C		Lower temperature
Bemessungsspannung	400 V	250 V	Rated voltage
Bemessungs-Stoßspannung	6000 V	4000 V	Rated impulse voltage
Verschmutzungsgrad	3		Pollution degree
Überspannungskategorie	III		Overvoltage categorie
Isolierstoffgruppe	III		Material group
Bemessungsstrom (40°C)	16 A	8 A	Rated current (40 °C)
Durchgangswiderstand	≤ 5 mΩ		Contact resistance
Material Kontakt	CuZn (Messing/brass)		Material of contact
Kontaktoberfläche	Ag (Silber/silver)		Contact plating
Material Kontaktkörper	PA 12		Material of contact body
Material Gehäuse	PUR		Material of housing



**Leistungs Steckverbinder Serie 692 - 693**  
**Power connectors series 692 - 693**

Bezeichnung  
Description

Kabeldose, PG9  
Female cable connector, PG9

Kabeldose, PG9 mit VDE, SEV, UL Zulassung  
Female cable connector, PG9 with VDE, SEV, UL approval

Abbildung  
Figure

Crimpkontakte siehe Seite 27.  
Crimp contacts see page 27.

Crimpkontakte siehe Seite 27.  
Crimp contacts see page 27.



Maßzeichnung  
Drawing

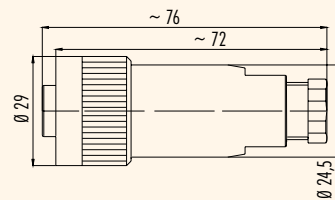
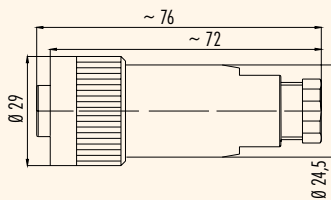

Bestell-Nr.  
Ordering-No.

Polzahl Contacts	Anschlussart Termination	Kabeldurchlass (mm) Cable outlet (mm)	Bestell-Nr. Ordering-No.
3+PE	schrauben screw	6-9,5	99-0210-00-04
6+PE	löten solder	6-9,5	99-0214-00-07
6+PE	schrauben screw	6-8	99-0218-00-07
6+PE	crimpen crimp	6-8	99-0202-00-07

Polzahl Contacts	Anschlussart Termination	Kabeldurchlass (mm) Cable outlet (mm)	Bestell-Nr. Ordering-No.
3+PE	schrauben screw	6-9,5	99-4222-00-04
6+PE	löten solder	6-9,5	99-4226-00-07
6+PE	schrauben screw	6-8	99-4218-00-07
6+PE	crimpen crimp	6-8	99-4202-00-07

Technische Daten  
Specifications

Polzahl	3+PE	6+PE	6+PE	6+PE	Number of contacts
Steckverbinder Verriegelung	schrauben/screw				Connector locking system
Anschlussart	schrauben/screw	löten/solder	schrauben/screw	crimpen/crimp	Termination
Anschlussquerschnitt	0,5-2,5 mm <sup>2</sup> (AWG 20-14)	max. 0,75 mm <sup>2</sup> (max. AWG 18)	0,34-1,5 mm <sup>2</sup> (AWG 22-16)	0,14-1,5 mm <sup>2</sup> (AWG 26-16)	Wire gauge
Kabeldurchlass	6-8 mm, 6-9,5 mm				Cable outlet
Schutzart	IP67 <sup>1)</sup>				Degree of protection
Mechanische Lebensdauer	> 500 Steckzyklen/> 500 mating cycles				Mechanical operation
Obere Grenztemperatur	+ 100 °C				Upper temperature
Untere Grenztemperatur	- 40 °C				Lower temperature
Bemessungsspannung	400 V (600 V UL)		250 V		Rated voltage
Bemessungs-Stoßspannung	6000 V		4000 V		Rated impulse voltage
Verschmutzungsgrad	3				Pollution degree
Überspannungskategorie	III				Overvoltage categorie
Isolierstoffgruppe	III				Material group
Bemessungsstrom (40 °C)	16 A (12 A UL)		10 A (8 A UL)		Rated current (40 °C)
Durchgangswiderstand	≤ 5 mΩ				Contact resistance
Material Kontakt	CuSn (Bronze/bronze), CuZn (Messing/brass)				Material of contact
Kontaktoberfläche	Ag (Silber/silver)				Contact plating
Material Kontaktkörper	PBT (UL 94 V-0)				Material of contact body
Material Gehäuse	PBT (UL 94 V-0)				Material of housing

**Leistungs Steckverbinder Serie 692 - 693**  
**Power connectors series 692 - 693**
**Bezeichnung**  
*Description*
**Abbildung**  
*Figure*
**Kabeldose, PG11**  
*Female cable connector, PG11*
**Crimpkontakte siehe Seite 27.**  
*Crimp contacts see page 27.*

**Kabeldose, PG11 mit VDE, SEV, UL Zulassung**  
*Female cable connector, PG11 with VDE, SEV, UL approval*
**Crimpkontakte siehe Seite 27.**  
*Crimp contacts see page 27.*

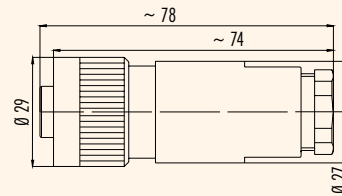
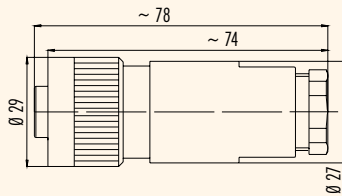
**Maßzeichnung**  
*Drawing*

**Bestell-Nr.**  
*Ordering-No.*

Polzahl Contacts	Anschlussart Termination	Kabeldurchlass (mm) Cable outlet (mm)	Bestell-Nr. Ordering-No.
3+PE	schrauben screw	8-10	99-0210-110-04
6+PE	löten solder	8-10	99-0214-110-07
6+PE	schrauben screw	8-10	99-0218-110-07
6+PE	crimpen crimp	8-10	99-0202-110-07

Polzahl Contacts	Anschlussart Termination	Kabeldurchlass (mm) Cable outlet (mm)	Bestell-Nr. Ordering-No.
3+PE	schrauben screw	8-10	99-4222-110-04
6+PE	löten solder	8-10	99-4226-110-07
6+PE	schrauben screw	8-10	99-4218-110-07
6+PE	crimpen crimp	8-10	99-4202-110-07

**Technische Daten**  
*Specifications*

Polzahl	3+PE	6+PE	6+PE	6+PE	Number of contacts
Steckverbinder Verriegelung	schrauben/screw				Connector locking system
Anschlussart	schrauben/screw	löten/solder	schrauben/screw	crimpen/crimp	Termination
Anschlussquerschnitt	0,5-2,5 mm <sup>2</sup> (AWG 20-14)	max. 0,75 mm <sup>2</sup> (max. AWG 18)	0,34-1,5 mm <sup>2</sup> (AWG 22-16)	0,14-1,5 mm <sup>2</sup> (AWG 26-16)	Wire gauge
Kabeldurchlass	8-10 mm				Cable outlet
Schutzart	IP67				Degree of protection
Mechanische Lebensdauer	> 500 Steckzyklen/> 500 mating cycles				Mechanical operation
Obere Grenztemperatur	+ 100 °C				Upper temperature
Untere Grenztemperatur	- 40 °C				Lower temperature
Bemessungsspannung	400 V (600 V UL)		250 V		Rated voltage
Bemessungs-Stoßspannung	6000 V		4000 V		Rated impulse voltage
Verschmutzungsgrad	3				Pollution degree
Überspannungskategorie	III				Overvoltage categorie
Isolierstoffgruppe	III				Material group
Bemessungsstrom (40°C)	16 A (12 A UL)		10 A (8 A UL)		Rated current (40 °C)
Durchgangswiderstand	≤ 5 mΩ				Contact resistance
Material Kontakt	CuSn (Bronze/bronce), CuZn (Messing/brass)				Material of contact
Kontaktoberfläche	Ag (Silber/silver)				Contact plating
Material Kontaktkörper	PBT (UL 94 V-0)				Material of contact body
Material Gehäuse	PBT (UL 94 V-0)				Material of housing

## Leistungs Steckverbinder Serie 692 - 693

### Power connectors series 692 - 693

Bezeichnung  
Description

Kabeldose, PG13,5  
Female cable connector, PG13,5

Kabeldose, PG13,5 mit VDE, SEV, UL Zulassung  
Female cable connector, PG13,5 with VDE, SEV, UL approval

Abbildung  
Figure

Crimpkontakte siehe Seite 27.  
Crimp contacts see page 27.

Crimpkontakte siehe Seite 27.  
Crimp contacts see page 27.



Maßzeichnung  
Drawing

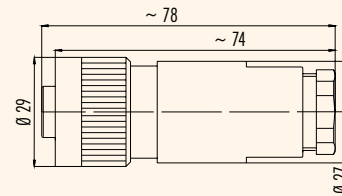
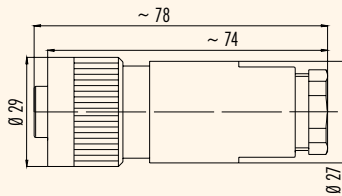

Bestell-Nr.  
Ordering-No.

Polzahl Contacts	Anschlussart Termination	Kabeldurchlass (mm) Cable outlet (mm)	Bestell-Nr. Ordering-No.	Polzahl Contacts	Anschlussart Termination	Kabeldurchlass (mm) Cable outlet (mm)	Bestell-Nr. Ordering-No.
3+PE	schrauben screw	10-12	99-0210-15-04	3+PE	schrauben screw	10-12	99-4222-14-04
6+PE	löten solder	10-12	99-0214-15-07	6+PE	löten solder	10-12	99-4226-14-07
6+PE	schrauben screw	10-12	99-0218-15-07	6+PE	schrauben screw	10-12	99-4218-14-07
6+PE	crimpen crimp	10-12	99-0202-15-07	6+PE	crimpen crimp	10-12	99-4202-14-07

Technische Daten  
Specifications

Polzahl	3+PE	6+PE	6+PE	6+PE	Number of contacts
Steckverbinder Verriegelung	schrauben/screw				Connector locking system
Anschlussart	schrauben/screw	löten/solder	schrauben/screw	crimpen/crimp	Termination
Anschlussquerschnitt	0,5-2,5 mm <sup>2</sup> (AWG 20-14)	max. 0,75 mm <sup>2</sup> (max. AWG 18)	0,34-1,5 mm <sup>2</sup> (AWG 22-16)	0,14-1,5 mm <sup>2</sup> (AWG 26-16)	Wire gauge
Kabeldurchlass	10-12 mm				Cable outlet
Schutzart	IP67				Degree of protection
Mechanische Lebensdauer	> 500 Steckzyklen/> 500 mating cycles				Mechanical operation
Obere Grenztemperatur	+ 100 °C				Upper temperature
Untere Grenztemperatur	- 40 °C				Lower temperature
Bemessungsspannung	400 V (600 V UL)		250 V		Rated voltage
Bemessungs-Stoßspannung	6000 V		4000 V		Rated impulse voltage
Verschmutzungsgrad	3				Pollution degree
Überspannungskategorie	III				Overvoltage categorie
Isolierstoffgruppe	III				Material group
Bemessungsstrom (40 °C)	16 A (12 A UL)		10 A (8 A UL)		Rated current (40 °C)
Durchgangswiderstand	≤ 5 mΩ				Contact resistance
Material Kontakt	CuSn (Bronze/bronze), CuZn (Messing/brass)				Material of contact
Kontaktoberfläche	Ag (Silber/silver)				Contact plating
Material Kontaktkörper	PBT (UL 94 V-0)				Material of contact body
Material Gehäuse	PBT (UL 94 V-0)				Material of housing

**Leistungs Steckverbinder Serie 692 - 693**  
**Power connectors series 692 - 693**
**Bezeichnung**  
*Description*
**Abbildung**  
*Figure*
**Kabeldose, PG16**  
*Female cable connector, PG16*
**Crimpkontakte siehe Seite 27.**  
*Crimp contacts see page 27.*

**Kabeldose, PG16 mit VDE, SEV, UL Zulassung**  
*Female cable connector, PG16 with VDE, SEV, UL approval*
**Crimpkontakte siehe Seite 27.**  
*Crimp contacts see page 27.*

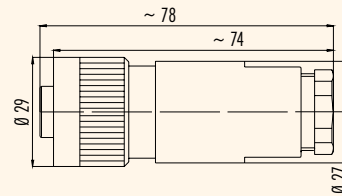
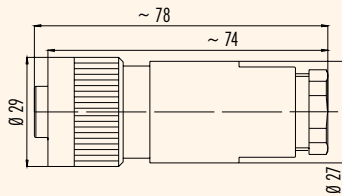
**Maßzeichnung**  
*Drawing*

**Bestell-Nr.**  
*Ordering-No.*

Polzahl Contacts	Anschlussart Termination	Kabeldurchlass (mm) Cable outlet (mm)	Bestell-Nr. Ordering-No.	Polzahl Contacts	Anschlussart Termination	Kabeldurchlass (mm) Cable outlet (mm)	Bestell-Nr. Ordering-No.
3+PE	<b>schrauben</b> <i>screw</i>	12-14	99-0210-160-04	3+PE	<b>schrauben</b> <i>screw</i>	12-14	99-4222-160-04
6+PE	<b>löten</b> <i>solder</i>	12-14	99-0214-160-07	6+PE	<b>löten</b> <i>solder</i>	12-14	99-4226-160-07
6+PE	<b>schrauben</b> <i>screw</i>	12-14	99-0218-160-07	6+PE	<b>schrauben</b> <i>screw</i>	12-14	99-4218-160-07
6+PE	<b>crimpen</b> <i>crimp</i>	12-14	99-0202-160-07	6+PE	<b>crimpen</b> <i>crimp</i>	12-14	99-4202-160-07

**Technische Daten**  
*Specifications*

Polzahl	3+PE	6+PE	6+PE	6+PE	Number of contacts
Steckverbinder Verriegelung	schrauben/screw				Connector locking system
Anschlussart	schrauben/screw	löten/solder	schrauben/screw	crimpen/crimp	Termination
Anschlussquerschnitt	0,5-2,5 mm <sup>2</sup> (AWG 20-14)	max. 0,75 mm <sup>2</sup> (max. AWG 18)	0,34-1,5 mm <sup>2</sup> (AWG 22-16)	0,14-1,5 mm <sup>2</sup> (AWG 26-16)	Wire gauge
Kabeldurchlass	12-14 mm				Cable outlet
Schutzart	IP67				Degree of protection
Mechanische Lebensdauer	> 500 Steckzyklen/> 500 mating cycles				Mechanical operation
Obere Grenztemperatur	+ 100 °C				Upper temperature
Untere Grenztemperatur	- 40 °C				Lower temperature
Bemessungsspannung	400 V (600 V UL)		250 V		Rated voltage
Bemessungs-Stoßspannung	6000 V		4000 V		Rated impulse voltage
Verschmutzungsgrad	3				Pollution degree
Überspannungskategorie	III				Overvoltage categorie
Isolierstoffgruppe	III				Material group
Bemessungsstrom (40°C)	16 A (12 A UL)		10 A (8 A UL)		Rated current (40 °C)
Durchgangswiderstand	≤ 5 mΩ				Contact resistance
Material Kontakt	CuSn (Bronze/bronze), CuZn (Messing/brass)				Material of contact
Kontaktoberfläche	Ag (Silber/silver)				Contact plating
Material Kontaktkörper	PBT (UL 94 V-0)				Material of contact body
Material Gehäuse	PBT (UL 94 V-0)				Material of housing

## Leistungs Steckverbinder Serie 692 - 693

### Power connectors series 692 - 693

Bezeichnung  
Description

Winkeldose, PG9  
Female angled connector, PG9

Abbildung  
Figure

Crimpkontakte siehe Seite 27.  
Crimp contacts see page 27.



Winkeldose, PG9 mit VDE, SEV, UL Zulassung  
Female angled connector, PG9 with VDE, SEV, UL approval

Crimpkontakte siehe Seite 27.  
Crimp contacts see page 27.



Maßzeichnung  
Drawing

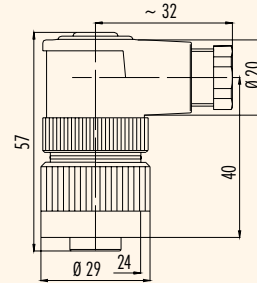
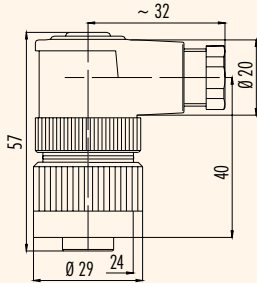

Bestell-Nr.  
Ordering-No.

Polzahl Contacts	Anschlussart Termination	Kabeldurchlass (mm) Cable outlet (mm)	Bestell-Nr. Ordering-No.
3+PE	schrauben screw	6-8	99-0210-70-04
6+PE	löten solder	6-8	99-0214-70-07
6+PE	schrauben screw	6-8	99-0218-70-07
6+PE	crimpen crimp	6-8	99-0202-70-07

Polzahl Contacts	Anschlussart Termination	Kabeldurchlass (mm) Cable outlet (mm)	Bestell-Nr. Ordering-No.
3+PE	schrauben screw	6-8	99-4222-70-04
6+PE	löten solder	6-8	99-4226-70-07
6+PE	schrauben screw	6-8	99-4218-70-07
6+PE	crimpen crimp	6-8	99-4202-70-07

Technische Daten  
Specifications

Polzahl	3+PE	6+PE	6+PE	6+PE	Number of contacts
Steckverbinder Verriegelung	schrauben/screw				Connector locking system
Anschlussart	schrauben/screw	löten/solder	schrauben/screw	crimpen/crimp	Termination
Anschlussquerschnitt	0,5-2,5 mm <sup>2</sup> (AWG 20-14)	max. 0,75 mm <sup>2</sup> (max. AWG 18)	0,34-1,5 mm <sup>2</sup> (AWG 22-16)	0,14-1,5 mm <sup>2</sup> (AWG 26-16)	Wire gauge
Kabeldurchlass	6-8 mm				Cable outlet
Schutzart	IP67 <sup>1)</sup>				Degree of protection
Mechanische Lebensdauer	> 500 Steckzyklen/> 500 mating cycles				Mechanical operation
Obere Grenztemperatur	+ 100 °C				Upper temperature
Untere Grenztemperatur	- 40 °C				Lower temperature
Bemessungsspannung	400 V (600 V UL)	250 V		4000 V	Rated voltage
Bemessungs-Stoßspannung	6000 V	4000 V			Rated impulse voltage
Verschmutzungsgrad	3				Pollution degree
Überspannungskategorie	III				Overvoltage categorie
Isolierstoffgruppe	III				Material group
Bemessungsstrom (40 °C)	16 A (12 A UL)	10 A (8 A UL)			Rated current (40 °C)
Durchgangswiderstand	≤ 5 mΩ				Contact resistance
Material Kontakt	CuSn (Bronze/bronze), CuZn (Messing/brass)				Material of contact
Kontaktoberfläche	Ag (Silber/silver)				Contact plating
Material Kontaktkörper	PBT (UL 94 V-0)				Material of contact body
Material Gehäuse	PBT (UL 94 V-0)				Material of housing

**Leistungs Steckverbinder Serie 692 - 693**  
**Power connectors series 692 - 693**

Bezeichnung  
Description

Abbildung  
Figure

Kabeldose  
Female cable connector

Technische Kabeldaten siehe Seite 24.  
Specifications of cable see page 24.



Winkeldose  
Female angled connector

Technische Kabeldaten siehe Seite 24.  
Specifications of cable see page 24.



Maßzeichnung  
Drawing

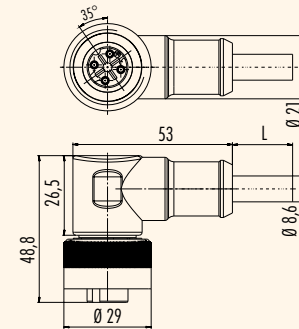
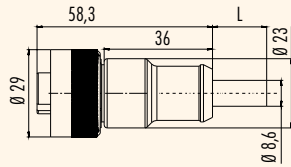

Bestell-Nr.  
Ordering-No.

Polzahl Contacts	Kabellänge (m) Cable length (m)	Bestell-Nr. Ordering-No.
3+PE 4 x 1,5 PVC	2	79-0232-20-04
6+PE 7 x 0,75 PVC		79-0236-20-07

Polzahl Contacts	Kabellänge (m) Cable length (m)	Bestell-Nr. Ordering-No.
3+PE 4 x 1,5 PVC	2	79-0234-20-04
6+PE 7 x 0,75 PVC		79-0238-20-07

Technische Daten  
Specifications

	3+PE	6+PE	
Polzahl	3+PE	6+PE	Number of contacts
Steckverbinder Verriegelung	schrauben/screw		Connector locking system
Anschlussart	crimpen, am Kabel angespritzt/crimp, moulded		Termination
Anschlussquerschnitt	1,5 mm <sup>2</sup> (AWG 16)	0,75 mm <sup>2</sup> (AWG 18)	Wire gauge
Kabeldurchlass	-		Cable outlet
Schutzart	IP67		Degree of protection
Mechanische Lebensdauer	> 500 Steckzyklen/> 500 mating cycles		Mechanical operation
Obere Grenztemperatur	+ 80 °C		Upper temperature
Untere Grenztemperatur	- 25 °C		Lower temperature
Bemessungsspannung	400 V	250 V	Rated voltage
Bemessungs-Stoßspannung	6000 V	4000 V	Rated impulse voltage
Verschmutzungsgrad	3		Pollution degree
Überspannungskategorie	III		Overvoltage categorie
Isolierstoffgruppe	III		Material group
Bemessungsstrom (40 °C)	16 A	8 A	Rated current (40 °C)
Durchgangswiderstand	≤ 5 mΩ		Contact resistance
Material Kontakt	CuZn (Messing/brass)		Material of contact
Kontaktoberfläche	Ag (Silber/silver)		Contact plating
Material Kontaktkörper	PA 12		Material of contact body
Material Gehäuse	PUR		Material of housing

**Leistungs Steckverbinder Serie 692 - 693**  
**Power connectors series 692 - 693**

Bezeichnung  
Description

Flanschstecker 3+PE, Schraubanschluss  
Male socket 3+PE, screw termination

Abbildung  
Figure



Flanschstecker 3+PE, Schraubanschluss,  
VDE, SEV, UL Zulassung  
Male socket 3+PE, screw termination  
VDE, SEV, UL approval



Maßzeichnung  
Drawing

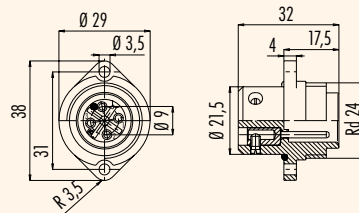
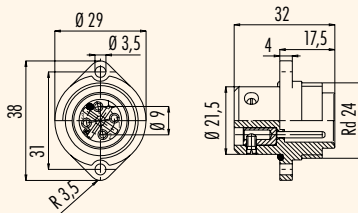

Bestell-Nr.  
Ordering-No.

Polzahl Contacts	Bestell-Nr. Ordering-No.
3+PE	09-0211-00-04

Polzahl Contacts	Bestell-Nr. Ordering-No.
3+PE	09-4223-00-04

Technische Daten  
Specifications

Polzahl	3+PE	Number of contacts
Steckverbinder Verriegelung	Schrauben/screw	Connector locking system
Anschlussart	Schrauben/screw	Termination
Anschlussquerschnitt	0,5-2,5 mm <sup>2</sup> (AWG 20-14)	Wire gauge
Kabeldurchlass	-	Cable outlet
Schutzart	IP67	Degree of protection
Mechanische Lebensdauer	> 500 Steckzyklen/> 500 mating cycles	Mechanical operation
Obere Grenztemperatur	+ 100 °C	Upper temperature
Untere Grenztemperatur	- 40 °C	Lower temperature
Bemessungsspannung	400 V (600 V UL)	Rated voltage
Bemessungs-Stoßspannung	6000 V	Rated impulse voltage
Verschmutzungsgrad	3	Pollution degree
Überspannungskategorie	III	Overvoltage categorie
Isolierstoffgruppe	III	Material group
Bemessungsstrom (40°C)	16 A (12 A UL)	Rated current (40 °C)
Durchgangswiderstand	≤ 5 mΩ	Contact resistance
Material Kontakt	CuZn (Messing/brass)	Material of contact
Kontaktfläche	Ag (Silber/silver)	Contact plating
Material Kontaktkörper	PBT	Material of contact body
Material Gehäuse	-	Material of housing

**Leistungs Steckverbinder Serie 692 - 693**  
**Power connectors series 692 - 693**

Bezeichnung  
Description

Flanschstecker 6+PE, Lötanschluss  
Male socket 6+PE, solder termination

Flanschstecker 6+PE, Lötanschluss  
**VDE, SEV, UL Zulassung**  
Male socket 6+PE, solder termination  
**VDE, SEV, UL approval**

Abbildung  
Figure



Maßzeichnung  
Drawing

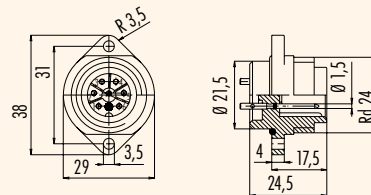
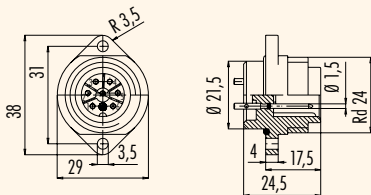

Bestell-Nr.  
Ordering-No.

Polzahl Contacts	Bestell-Nr. Ordering-No.
6+PE	09-0215-00-07

Polzahl Contacts	Bestell-Nr. Ordering-No.
6+PE	09-4227-00-07

**Technische Daten**  
Specifications

Polzahl	6+PE	Number of contacts
Steckverbinder Verriegelung	Schrauben/screw	Connector locking system
Anschlussart	Löten/solder	Termination
Anschlussquerschnitt	max. 0,75 mm <sup>2</sup> (max. AWG 20)	Wire gauge
Kabeldurchlass	-	Cable outlet
Schutzart	IP67	Degree of protection
Mechanische Lebensdauer	> 500 Steckzyklen/> 500 mating cycles	Mechanical operation
Obere Grenztemperatur	+ 100 °C	Upper temperature
Untere Grenztemperatur	- 40 °C	Lower temperature
Bemessungsspannung	250 V	Rated voltage
Bemessungs-Stoßspannung	4000 V	Rated impulse voltage
Verschmutzungsgrad	3	Pollution degree
Überspannungskategorie	III	Overvoltage category
Isolierstoffgruppe	III	Material group
Bemessungsstrom (40°C)	10 A (8 A UL)	Rated current (40 °C)
Durchgangswiderstand	≤ 5 mΩ	Contact resistance
Material Kontakt	CuZn (Messing/brass)	Material at contact
Kontaktfläche	Ag (Silber/silver)	Contact plating
Material Kontaktkörper	PBT	Material of contact body
Material Gehäuse	-	Material of housing



## Leistungs Steckverbinder Serie 692 - 693

### Power connectors series 692 - 693

Bezeichnung  
Description

Flanschstecker 6+PE, Schraubanschluss  
Male socket 6+PE, screw termination

Flanschstecker 6+PE, Schraubanschluss  
**VDE, SEV, UL Zulassung**  
Male socket 6+PE, screw termination  
**VDE, SEV, UL approval**

Abbildung  
Figure



Maßzeichnung  
Drawing

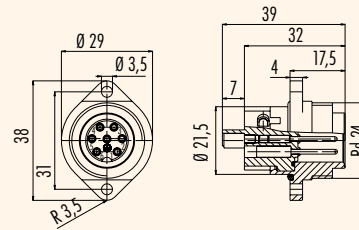
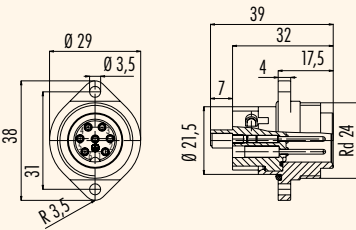

Bestell-Nr.  
Ordering-No.



Polzahl Contacts	Bestell-Nr. Ordering-No.
6+PE	09-0219-00-07

Polzahl Contacts	Bestell-Nr. Ordering-No.
6+PE	09-4219-00-07

Technische Daten  
Specifications

Polzahl	6+PE	Number of contacts
Steckverbinder Verriegelung	schrauben/screw	Connector locking system
Anschlussart	schrauben/screw	Termination
Anschlussquerschnitt	0,34-1,5 mm <sup>2</sup> (AWG 22-16)	Wire gauge
Kabeldurchlass	-	Cable outlet
Schutzart	IP67	Degree of protection
Mechanische Lebensdauer	> 500 Steckzyklen/> 500 mating cycles	Mechanical operation
Obere Grenztemperatur	+ 100 °C	Upper temperature
Untere Grenztemperatur	- 40 °C	Lower temperature
Bemessungsspannung	250 V	Rated voltage
Bemessungs-Stoßspannung	4000 V	Rated impulse voltage
Verschmutzungsgrad	3	Pollution degree
Überspannungskategorie	III	Overvoltage categorie
Isolierstoffgruppe	III	Material group
Bemessungsstrom (40°C)	10 A (8 V UL)	Rated current (40 °C)
Durchgangswiderstand	≤ 5 mΩ	Contact resistance
Material Kontakt	CuZn (Messing/brass)	Material of contact
Kontaktoberfläche	Ag (Silber/silver)	Contact plating
Material Kontaktkörper	PBT	Material of contact body
Material Gehäuse	PA (UL 94 V-0)	Material of housing

**Leistungs Steckverbinder Serie 692 - 693**  
**Power connectors series 692 - 693**

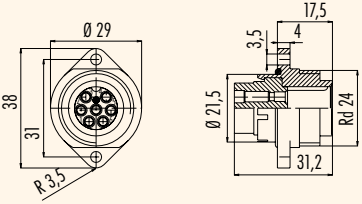
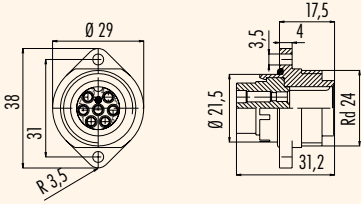
Bezeichnung Description	Flanschstecker 6+PE, Crimpschluss Male socket 6+PE, crimp termination	Flanschstecker 6+PE, Crimpschluss VDE, SEV, UL Zulassung Male socket 6+PE, crimp termination VDE, SEV, UL approval								
Abbildung Figure	<p>Crimpkontakte siehe Seite 27. Crimp contacts see page 27.</p> 	<p>Crimpkontakte siehe Seite 27. Crimp contacts see page 27.</p> 								
Maßzeichnung Drawing										
Bestell-Nr. Ordering-No.	<table border="1"> <thead> <tr> <th>Polzahl Contacts</th> <th>Bestell-Nr. Ordering-No.</th> </tr> </thead> <tbody> <tr> <td>6+PE</td> <td>09-0203-00-07</td> </tr> </tbody> </table>	Polzahl Contacts	Bestell-Nr. Ordering-No.	6+PE	09-0203-00-07	<table border="1"> <thead> <tr> <th>Polzahl Contacts</th> <th>Bestell-Nr. Ordering-No.</th> </tr> </thead> <tbody> <tr> <td>6+PE</td> <td>09-4203-00-07</td> </tr> </tbody> </table>	Polzahl Contacts	Bestell-Nr. Ordering-No.	6+PE	09-4203-00-07
Polzahl Contacts	Bestell-Nr. Ordering-No.									
6+PE	09-0203-00-07									
Polzahl Contacts	Bestell-Nr. Ordering-No.									
6+PE	09-4203-00-07									

Technische Daten Specifications		
Polzahl	6+PE	Number of contacts
Steckverbinder Verriegelung	Schrauben/Screw	Connector locking system
Anschlussart	Crimpen/Crimp	Termination
Anschlussquerschnitt	0,14-1,5 mm <sup>2</sup> (AWG 26-16)	Wire gauge
Kabeldurchlass	-	Cable outlet
Schutzart	IP67	Degree of protection
Mechanische Lebensdauer	> 500 Steckzyklen/> 500 mating cycles	Mechanical operation
Obere Grenztemperatur	+ 100 °C	Upper temperature
Untere Grenztemperatur	- 40 °C	Lower temperature
Bemessungsspannung	250 V	Rated voltage
Bemessungs-Stoßspannung	4000 V	Rated impulse voltage
Verschmutzungsgrad	3	Pollution degree
Überspannungskategorie	III	Overvoltage categorie
Isolierstoffgruppe	III	Material group
Bemessungsstrom (40°C)	10 A (8 V UL)	Rated current (40 °C)
Durchgangswiderstand	-	Contact resistance
Material Kontakt	-	Material of contact
Kontaktoberfläche	-	Contact plating
Material Kontaktkörper	PBT	Material of contact body
Material Gehäuse	-	Material of housing

**Leistungs Steckverbinder Serie 692 - 693**  
**Power connectors series 692 - 693**

Bezeichnung  
Description

Flanschdose 3+PE, **Schraubanschluss**  
Female socket 3+PE, **screw termination**

Abbildung  
Figure



Flanschdose 3+PE, **Schraubanschluss**  
**VDE, SEV, UL Zulassung**  
Female socket 3+PE, **screw termination**  
**VDE, SEV, UL approval**



Maßzeichnung  
Drawing

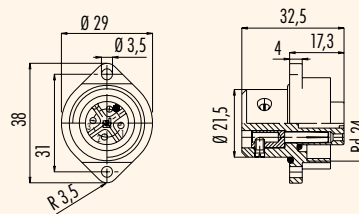
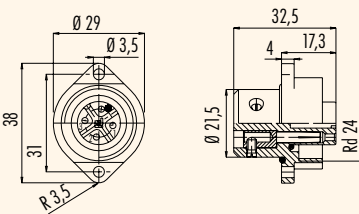

Bestell-Nr.  
Ordering-No.

Polzahl Contacts	Bestell-Nr. Ordering-No.
3+PE	09-0212-00-04

Polzahl Contacts	Bestell-Nr. Ordering-No.
3+PE	09-4224-00-04

**Technische Daten**  
Specifications

Polzahl	3+PE	Number of contacts
Steckverbinder Verriegelung	Schrauben/screw	Connector locking system
Anschlussart	Schrauben/screw	Termination
Anschlussquerschnitt	0,5-2,5 mm <sup>2</sup> (AWG 20-14)	Wire gauge
Kabeldurchlass	-	Cable outlet
Schutzart	IP67	Degree of protection
Mechanische Lebensdauer	> 500 Steckzyklen/> 500 mating cycles	Mechanical operation
Obere Grenztemperatur	+ 100 °C	Upper temperature
Untere Grenztemperatur	- 40 °C	Lower temperature
Bemessungsspannung	400 V (600 V UL)	Rated voltage
Bemessungs-Stoßspannung	6000 V	Rated impulse voltage
Verschmutzungsgrad	3	Pollution degree
Überspannungskategorie	III	Overvoltage categorie
Isolierstoffgruppe	III	Material group
Bemessungsstrom (40°C)	16 A (12 A UL)	Rated current (40 °C)
Durchgangswiderstand	≤ 5 mΩ	Contact resistance
Material Kontakt	CuZn (Messing/brass)	Material of contact
Kontaktoberfläche	Ag (Silber/silver)	Contact plating
Material Kontaktkörper	PBT	Material of contact body
Material Gehäuse	-	Material of housing

**Leistungs Steckverbinder Serie 692 - 693**  
**Power connectors series 692 - 693**

Bezeichnung  
Description

Flanschdose 6+PE, Lötanschluss  
Female socket 6+PE, solder termination

Flanschdose 6+PE, Lötanschluss  
**VDE, SEV, UL Zulassung**  
Female socket 6+PE, solder termination  
**VDE, SEV, UL approval**

Abbildung  
Figure



Maßzeichnung  
Drawing

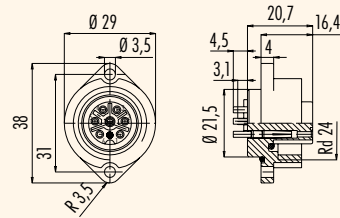
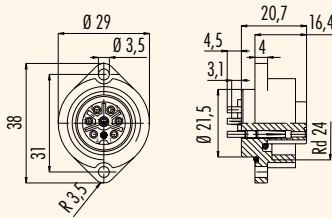

Bestell-Nr.  
Ordering-No.

Polzahl Contacts	Bestell-Nr. Ordering-No.
6+PE	09-0216-00-07

Polzahl Contacts	Bestell-Nr. Ordering-No.
6+PE	09-4228-00-07

**Technische Daten**  
Specifications

	6+PE	Number of contacts
Steckverbinder Verriegelung	Schrauben/screw	Connector locking system
Anschlussart	Löten/solder	Termination
Anschlussquerschnitt	max. 0,75 mm <sup>2</sup> (max. AWG 20)	Wire gauge
Kabeldurchlass	-	Cable outlet
Schutzart	IP67	Degree of protection
Mechanische Lebensdauer	> 500 Steckzyklen/> 500 mating cycles	Mechanical operation
Obere Grenztemperatur	+ 100 °C	Upper temperature
Untere Grenztemperatur	- 40 °C	Lower temperature
Bemessungsspannung	250 V	Rated voltage
Bemessungs-Stoßspannung	4000 V	Rated impulse voltage
Verschmutzungsgrad	3	Pollution degree
Überspannungskategorie	III	Overvoltage categorie
Isolierstoffgruppe	III	Material group
Bemessungsstrom (40°C)	10 A (8 A UL)	Rated current (40 °C)
Durchgangswiderstand	≤ 5 mΩ	Contact resistance
Material Kontakt	CuSn (Bronze/bronze)	Material at contact
Kontaktoberfläche	Ag (Silber/silver)	Contact plating
Material Kontaktkörper	PBT	Material of contact body
Material Gehäuse	-	Material of housing

**Leistungs Steckverbinder Serie 692 - 693**  
**Power connectors series 692 - 693**

Bezeichnung  
Description

Flanschdose 6+PE, **Schraubanschluss**  
Female socket 6+PE, **screw termination**

Flanschdose 6+PE, **Schraubanschluss**  
**VDE, SEV, UL Zulassung**  
Female socket 6+PE, **screw termination**  
**VDE, SEV, UL approval**

Abbildung  
Figure



Maßzeichnung  
Drawing

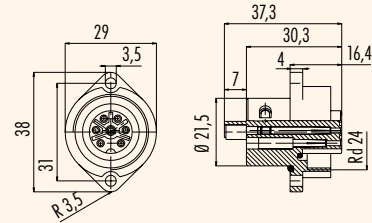
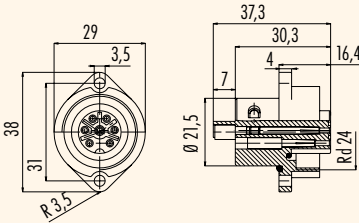

Bestell-Nr.  
Ordering-No.

Polzahl Contacts	Bestell-Nr. Ordering-No.
6+PE	09-0220-00-07

Polzahl Contacts	Bestell-Nr. Ordering-No.
6+PE	09-4220-00-07

**Technische Daten**  
Specifications

Polzahl	6+PE	Number of contacts
Steckverbinder Verriegelung	schrauben/screw	Connector locking system
Anschlussart	schrauben/screw	Termination
Anschlussquerschnitt	0,34-1,5 mm <sup>2</sup> (AWG 22-16)	Wire gauge
Kabeldurchlass	-	Cable outlet
Schutzart	IP67	Degree of protection
Mechanische Lebensdauer	> 500 Steckzyklen/> 500 mating cycles	Mechanical operation
Obere Grenztemperatur	+ 100 °C	Upper temperature
Untere Grenztemperatur	- 40 °C	Lower temperature
Bemessungsspannung	250 V	Rated voltage
Bemessungs-Stoßspannung	4000 V	Rated impulse voltage
Verschmutzungsgrad	3	Pollution degree
Überspannungskategorie	III	Overvoltage categorie
Isolierstoffgruppe	III	Material group
Bemessungsstrom (40°C)	10 A (8 A UL)	Rated current (40 °C)
Durchgangswiderstand	≤ 5 mΩ	Contact resistance
Material Kontakt	CuSn (Bronze/bronze)	Material of contact
Kontaktoberfläche	Ag (Silber/silver)	Contact plating
Material Kontaktkörper	PBT	Material of contact body
Material Gehäuse	-	Material of housing

**Leistungs Steckverbinder Serie 692 - 693**  
**Power connectors series 692 - 693**

**Bezeichnung**  
Description

**Abbildung**  
Figure

Flanschdose 6+PE, **Crimpschluss**  
Female socket 6+PE, **crimp termination**

Crimpkontakte siehe Seite 27.  
Crimp contacts see page 27.



Flanschdose 6+PE, **Crimpschluss**  
**VDE, SEV, UL Zulassung**  
Female socket 6+PE, **crimp termination**  
**VDE, SEV, UL approval**

Crimpkontakte siehe Seite 27.  
Crimp contacts see page 27.



**Maßzeichnung**  
Drawing

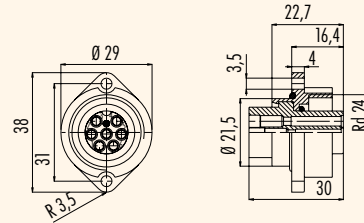
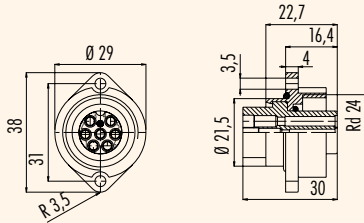

**Bestell-Nr.**  
Ordering-No.

Polzahl Contacts	Bestell-Nr. Ordering-No.
6+PE	09-0204-00-07

Polzahl Contacts	Bestell-Nr. Ordering-No.
6+PE	09-4204-00-07

**Technische Daten**  
Specifications

Polzahl	6+PE	Number of contacts
Steckverbinder Verriegelung	Schrauben/Screw	Connector locking system
Anschlussart	Crimpen/Crimp	Termination
Anschlussquerschnitt	0,14-1,5 mm <sup>2</sup> (AWG 26-16)	Wire gauge
Kabeldurchlass	-	Cable outlet
Schutzart	IP67	Degree of protection
Mechanische Lebensdauer	> 500 Steckzyklen/> 500 mating cycles	Mechanical operation
Obere Grenztemperatur	+ 100 °C	Upper temperature
Untere Grenztemperatur	- 40 °C	Lower temperature
Bemessungsspannung	250 V	Rated voltage
Bemessungs-Stoßspannung	4000 V	Rated impulse voltage
Verschmutzungsgrad	3	Pollution degree
Überspannungskategorie	III	Overvoltage categorie
Isolierstoffgruppe	III	Material group
Bemessungsstrom (40°C)	10 A (8 A UL)	Rated current (40 °C)
Durchgangswiderstand	-	Contact resistance
Material Kontakt	-	Material of contact
Kontaktoberfläche	-	Contact plating
Material Kontaktkörper	PBT	Material of contact body
Material Gehäuse	-	Material of housing

**Leistungs Steckverbinder Serie 692 - 693**  
**Power connectors series 692 - 693**

Einzelteildarstellung  
 Component part drawing

**Kabelsteckverbinder**  
 Cable connectors

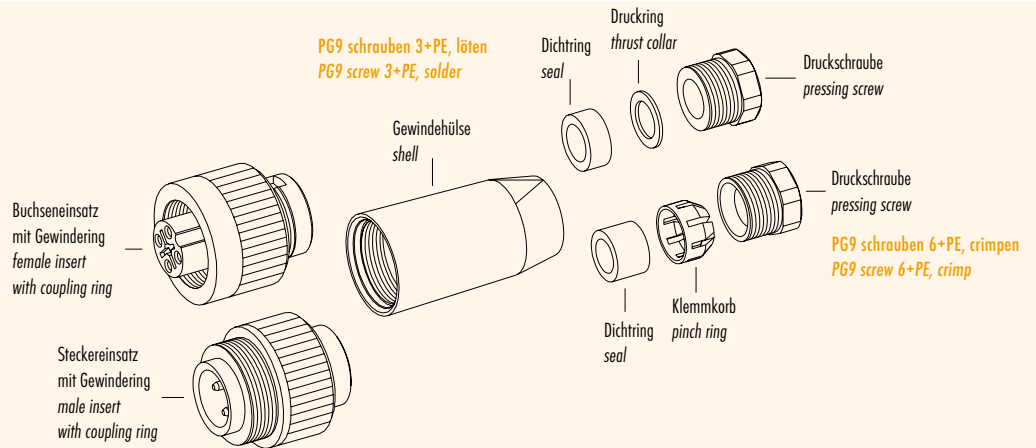

**Kabelsteckverbinder mit Kabelzugentlastung PG9 Version UL, VDE, SEV (schrauben 3+PE, löten)**  
 Cable connectors with cable clamp PG9 version UL, VDE, SEV (screw 3+PE, solder)

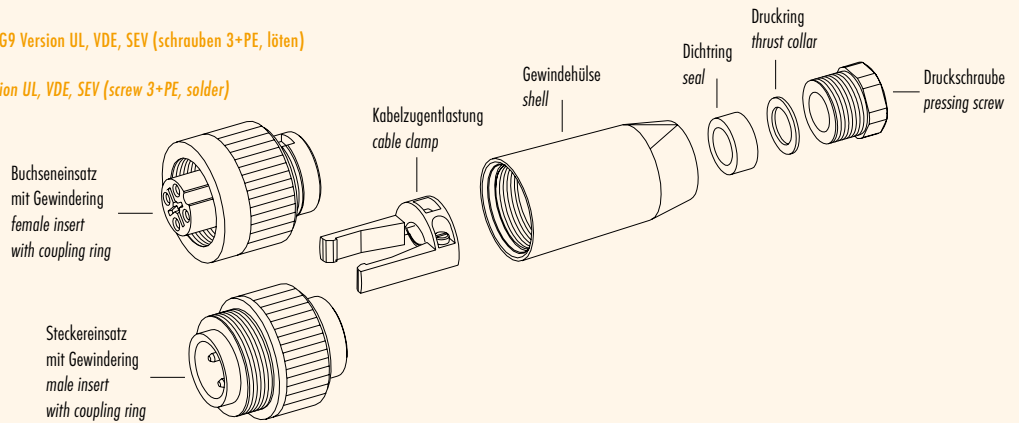

**Kabelsteckverbinder mit Klemmkorb PG11-, PG13,5-, PG16 Version**  
 Cable connectors with pinch ring PG11-, PG13,5-, PG16 version

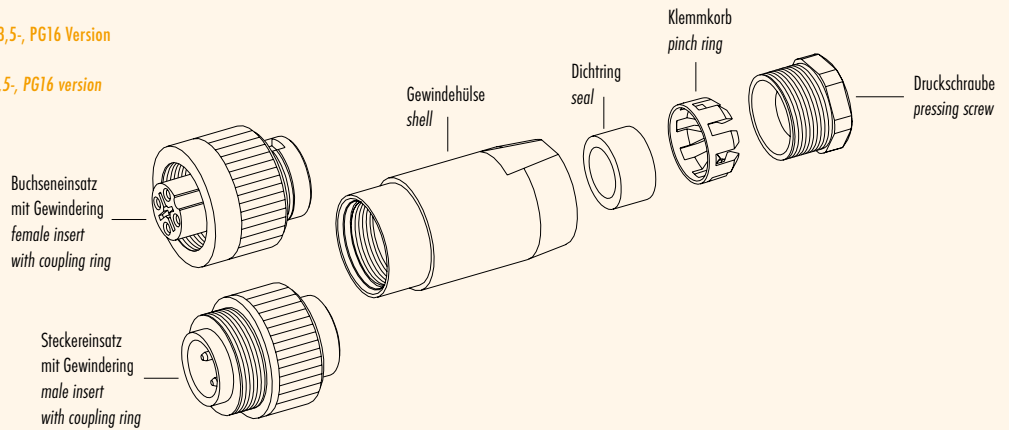

**Winkelsteckverbinder**  
 Angled connectors

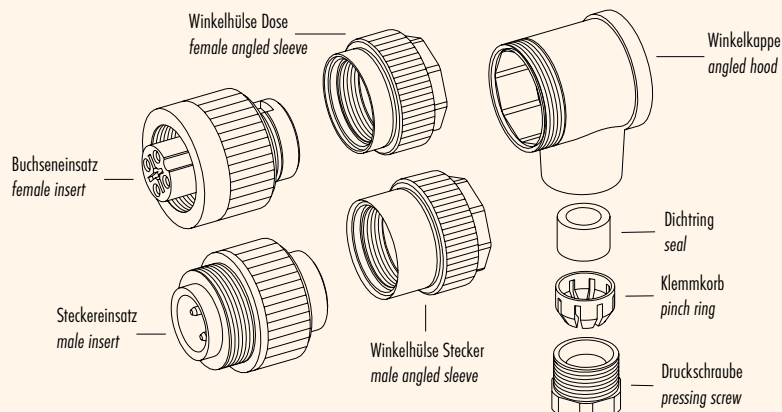

**Leistungs Steckverbinder Serie 692 - 693**  
**Power connectors series 692 - 693**

Technische Daten Specifications of	Standard Kabel standard cable		
Polzahl	4	7	Contacts
Querschnitt mm <sup>2</sup> <sup>1)</sup>	4 x 1,5 mm <sup>2</sup>	4 x 0,75 mm <sup>2</sup>	Wire gauge mm <sup>2</sup> <sup>1)</sup>
Material Mantel	PVC schwarz / black		Material jacket
Isolation Litze	PVC (schwarz, grün/gelb / black, green/yellow)		Insulation wire
Litzenaufbau (mm)	28 x 0,25	24 x 0,20	Design of wire (mm)
Kabelmantel (mm)	8,6	9,7	Cable jacket (mm)
Leiterwiderstand	-		Resistance of wire
Temperaturbereich (Kabel bewegt)	- 5 °C / + 80 °C		Temperature range (cable in move)
Temperaturbereich (Kabel fest)	- 20 °C / + 80 °C		Temperature range (cable not in move)
Biegeradius (Kabel bewegt)	60 mm		Bending radius (cable in move)
Biegeradius (Kabel fest)	120 mm		Bending radius (cable not in move)
Zulassung	UL, CSA		Approval

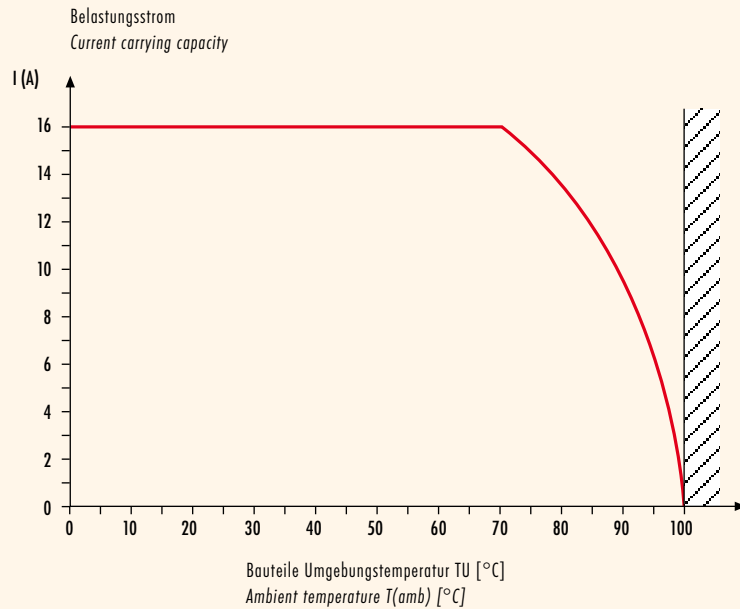
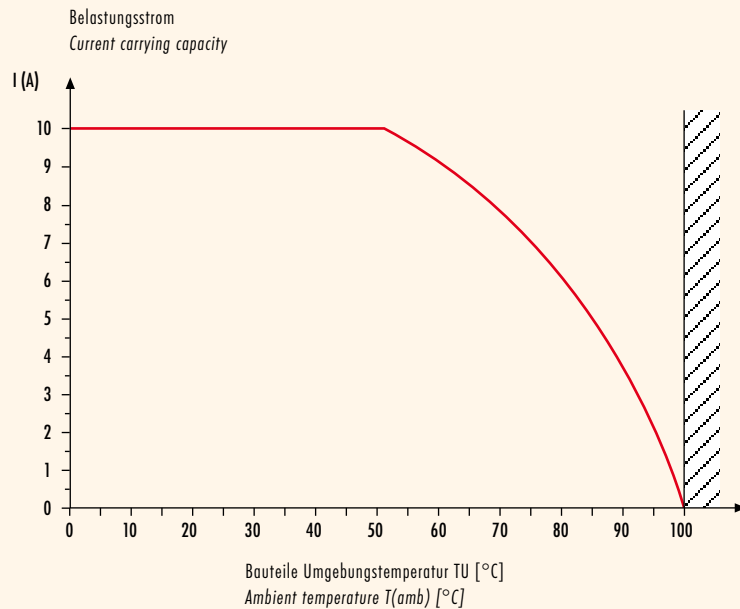
**Kennlinien  
Ratings**
**Strombelastbarkeitskurve 3+PE**  
**Derating curve 3+PE**

**Strombelastbarkeitskurve 6+PE**  
**Derating curve 6+PE**

<sup>1)</sup> Vergleichbare AWG Leiter siehe Seite TI-5. / <sup>1)</sup> Comparable AWG conductors see page TI-5.

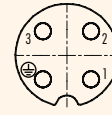

**Leistungs Steckverbinder Serie 692 - 693**  
**Power connectors series 692 - 693**
**Polbilder**  
*Contact arrangements*
**Stifteinsatz (Steckseite)**  
*Male insert (mating side)*
**Buchseinsatz (Steckseite)**  
*Female insert (mating side)*
**3+PE pol**  
*3+PE contacts*



	X	Y
1	-3,18	-3,18
2	-3,18	3,18
3	3,18	3,18
PE	3,18	-3,18

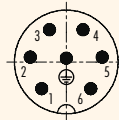

	X	Y
1	3,18	-3,18
2	3,18	3,18
3	-3,18	3,18
PE	-3,18	-3,18

**6+PE pol**  
*6+PE contacts*

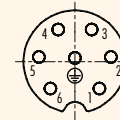
	X	Y
1	-3,25	-3,54
2	-4,76	0,63
3	-2,22	4,26
4	2,22	4,26
5	4,76	0,63
6	3,25	-3,54
PE	0,00	0,50

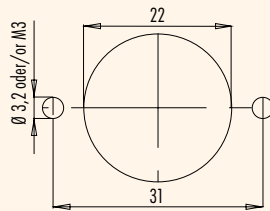

	X	Y
1	3,25	-3,54
2	4,76	0,63
3	2,22	4,26
4	-2,22	4,26
5	-4,76	0,63
6	-3,25	-3,54
PE	0,00	0,50

**Montageausschnitt**  
*Panel cut out*

Leistungs Steckverbinder Serie 692 - 693 Power connectors series 692 - 693		Zubehör Accessories	
<b>Bezeichnung</b> Description	Schutzkappe für Kabelstecker, IP 67 Protection cap for male cable connector, IP 67	Schutzkappe für Flanschstecker, IP 67 Protection cap for male socket, IP 67	Schutzkappe für Flanschstecker, IP 67 Protection cap for male socket, IP 67
<b>Abbildung</b> Figure			
<b>Maßzeichnung</b> Drawing			
<b>Bestell-Nr.</b> Ordering-No.	Bestell-Nr. Ordering-No. 08-2299-000-000	Bestell-Nr. Ordering-No. 08-2672-000-000	Bestell-Nr. Ordering-No. 08-2301-000-000
<b>Bezeichnung</b> Description	Schutzkappe für Kabeldose, IP 67 Protection cap for female cable connector, IP 67	Schutzkappe für Flanschdose, IP 67 Protection cap for female socket, IP 67	Schutzkappe für Flanschdose, IP 67 Protection cap for female socket, IP 67
<b>Abbildung</b> Figure			
<b>Maßzeichnung</b> Drawing			
<b>Bestell-Nr.</b> Ordering-No.	Bestell-Nr. Ordering-No. 08-2300-000-000	Bestell-Nr. Ordering-No. 08-2673-000-000	Bestell-Nr. Ordering-No. 08-2302-000-000
<b>Bezeichnung</b> Description	Zugentlastung Cable clamp	Flachdichtung für Flanschsteckverbinder Flat seal for sockets	Anbaugehäuse Bulkhead housing
<b>Abbildung</b> Figure			
<b>Maßzeichnung</b> Drawing			
<b>Bestell-Nr.</b> Ordering-No.	Bestell-Nr. Ordering-No. 08-0628-000-000	Bestell-Nr. Ordering-No. 04-0722-000	Bestell-Nr. Ordering-No. 16-0566-00-00

**Leistungs Steckverbinder Serie 692 - 693**  
**Power connectors series 692 - 693**

**Zubehör**  
**Accessories**

Bezeichnung  
Description

Schutzkappe für Anschlussseite, Flanschsteckverbinder mit Schraubanschluss  
 Protection cap - screw termination side for socket

Stiftkontakt (VE=100 Stck.)  
 Male contact (PU=100 pcs)

Buchsenkontakt (VE=100 Stck.)  
 Female contact (PU=100 pcs)

Abbildung  
Figure



Maßzeichnung  
Drawing

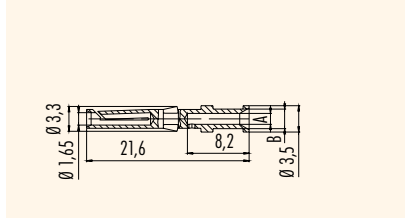
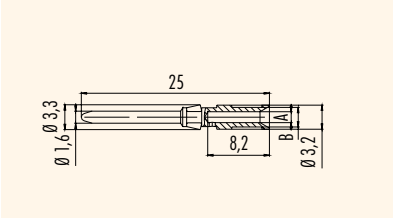
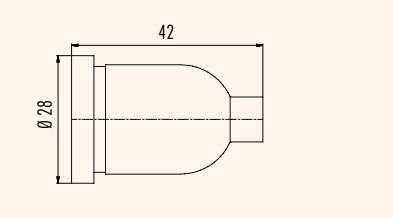

Bestell-Nr.  
Ordering-No.

Bestell-Nr. Ordering-No.	16-0565-00-00
-----------------------------	---------------

A	B	Für Leiterquerschnitt for wire gauge	AWG	Bestell-Nr. Ordering-No.
0,9	2,6	0,14-0,34 mm <sup>2</sup>	26-22	61-0891-139
1,1	2,6	0,5 mm <sup>2</sup>	20	61-0892-139
1,45	2,6	0,75-1 mm <sup>2</sup>	18	61-0893-139
1,8	3,0	1,5 mm <sup>2</sup>	16	61-0894-139

A	B	Für Leiterquerschnitt for wire gauge	AWG	Bestell-Nr. Ordering-No.
0,9	2,6	0,14-0,34 mm <sup>2</sup>	26-22	61-0896-139
1,1	2,6	0,5 mm <sup>2</sup>	20	61-0897-139
1,45	2,6	0,75-1 mm <sup>2</sup>	18	61-0898-139
1,8	3,0	1,5 mm <sup>2</sup>	16	61-0899-139

Bezeichnung  
Description

Crimpzange für gedrehte Crimpkontakte  
 Hand crimping tool for turned crimp contacts

Lösewerkzeug für Kontakte  
 Removal tool for contacts

Abbildung  
Figure



Bestell-Nr.  
Ordering-No.

Bestell-Nr. Ordering-No.	66-0003-001
-----------------------------	-------------

Bestell-Nr. Ordering-No.	66-0004-001
-----------------------------	-------------

**Technische Daten Kontakte**  
**Specifications of contacts**

Durchgangswiderstand	≤ 5 mΩ	Contact resistance
Material Kontakt	CuSn (Bronze/bronze)	Material of contact
Kontaktoberfläche	Ag (Silber/silver)	Contact plating

