



RD24 Steckverbinder

RD24 connectors

Kabelsteckverbinder

- Steckverbinder mit Schraubverriegelung
- Schutzart IP67 ¹⁾
- Varianten mit VDE-, SEV-, UL-Zulassung
- 3 Anschlusstechniken:
 - **LÖT**anschluss
 - **SCHRAUB**anschluss
 - **CRIMP**anschluss für gedrehte Crimpkontakte (die u.a. auch in schweren Rechtecksteckverbindern nach DIN 43 652 eingesetzt werden)

Cable Connector

- Connector with screw locking
- Degree of protection IP67 ¹⁾
- Versions with VDE-, SEV-, UL-approval
- 3 termination possibilities:
 - **SOLDER** termination
 - **SCREW** termination
 - **CRIMP** termination for turned crimp contacts (which are used in heavy duty rectangular connectors DIN 43652)



Aufbau des Steckverbinders:
Construction of the connector:

Kabelstecker
Male cable connector

Winkelstecker
Male angled connector

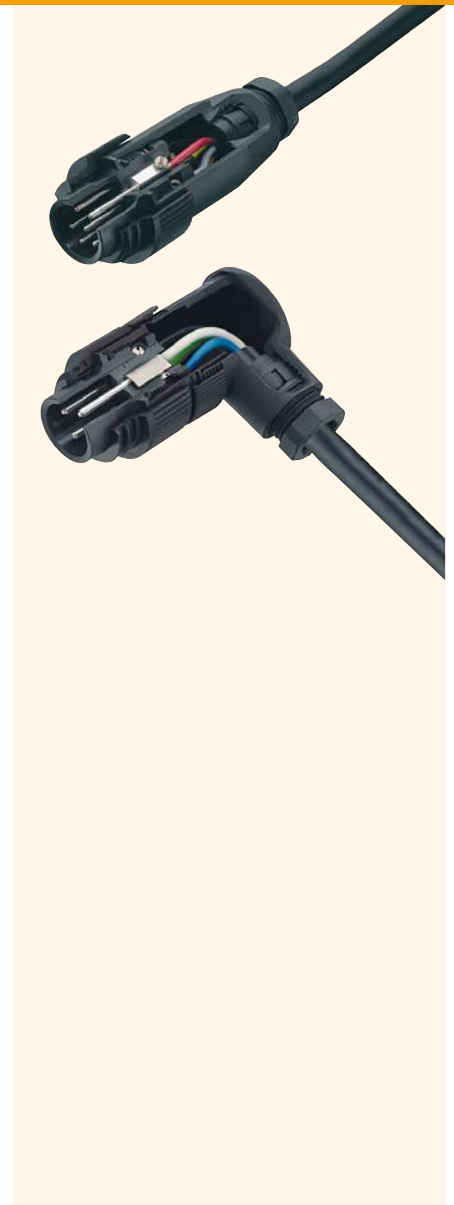

Leistungs Steckverbinder Serie 692 - 693
Power connectors series 692 - 693

Bezeichnung Description	Kabelstecker, PG9 Male cable connector, PG9	Kabelstecker, PG9 mit VDE, SEV, UL Zulassung Male cable connector, PG9 with VDE, SEV, UL approval
Abbildung Figure	<i>Crimpkontakte siehe Seite 27.</i> <i>Crimp contacts see page 27.</i>	<i>Crimpkontakte siehe Seite 27.</i> <i>Crimp contacts see page 27.</i>

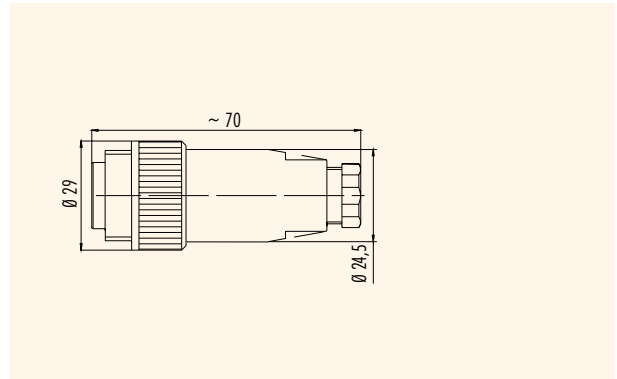
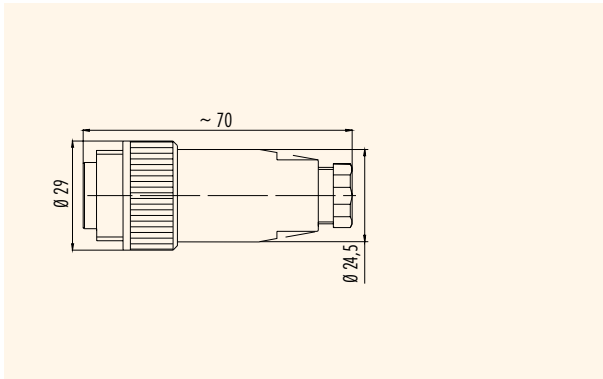
Maßzeichnung
Drawing

Bestell-Nr. Ordering-No.	Polzahl Contacts	Anschlussart Termination	Kabeldurchlass (mm) Cable outlet (mm)	Bestell-Nr. Ordering-No.	Polzahl Contacts	Anschlussart Termination	Kabeldurchlass (mm) Cable outlet (mm)	Bestell-Nr. Ordering-No.
	3+PE	schrauben screw	6-9,5	99-0209-00-04	3+PE	schrauben screw	6-9,5	99-4221-00-04
	6+PE	löten solder	6-9,5	99-0213-00-07	6+PE	löten solder	6-9,5	99-4225-00-07
	6+PE	schrauben screw	6-8	99-0217-00-07	6+PE	schrauben screw	6-8	99-4217-00-07
	6+PE	crimpen crimp	6-8	99-0201-00-07	6+PE	crimpen crimp	6-8	99-4201-00-07

Technische Daten
Specifications

Polzahl	3+PE	6+PE	6+PE	6+PE	Number of contacts
Steckverbinder Verriegelung	schrauben/screw				Connector locking system
Anschlussart	schrauben/screw	löten/solder	schrauben/screw	crimpen/crimp	Termination
Anschlussquerschnitt	0,5-2,5 mm ² (AWG 20-14)	max. 0,75 mm ² (max. AWG 18)	0,34-1,5 mm ² (AWG 22-16)	0,14-1,5 mm ² (AWG 26-16)	Wire gauge
Kabeldurchlass	6-8 mm, 6-9,5 mm				Cable outlet
Schutzart	IP67 ¹⁾				Degree of protection
Mechanische Lebensdauer	> 500 Steckzyklen / > 500 mating cycles				Mechanical operation
Obere Grenztemperatur	+ 100 °C				Upper temperature
Untere Grenztemperatur	- 40 °C				Lower temperature
Bemessungsspannung	400 V (600 V UL)		250 V		Rated voltage
Bemessungs-Stoßspannung	6000 V		4000 V		Rated impulse voltage
Verschmutzungsgrad	3				Pollution degree
Überspannungskategorie	III				Overvoltage categorie
Isolierstoffgruppe	III				Material group
Bemessungsstrom (40°C)	16 A (12 A UL)		10 A (8 A UL)		Rated current (40 °C)
Durchgangswiderstand	≤ 5 mΩ				Contact resistance
Material Kontakt	CuZn (Messing/brass)				Material of contact
Kontaktoberfläche	Ag (Silber/silver)				Contact plating
Material Kontaktkörper	PBT (UL 94 V-0)				Material of contact body
Material Gehäuse	PBT (UL 94 V-0)				Material of housing

Leistungs Steckverbinder Serie 692 - 693
Power connectors series 692 - 693

Bezeichnung
Description

Kabelstecker, PG11
Male cable connector, PG11

Kabelstecker, PG11 mit VDE, SEV, UL Zulassung
Male cable connector, PG11 with VDE, SEV, UL approval

Abbildung
Figure

Crimpkontakte siehe Seite 27.
Crimp contacts see page 27.

Crimpkontakte siehe Seite 27.
Crimp contacts see page 27.



Maßzeichnung
Drawing

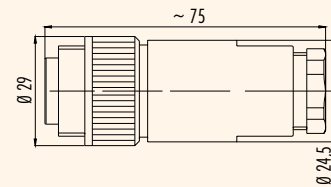
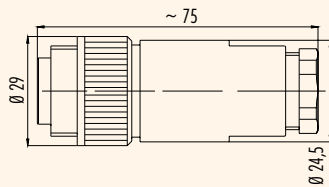

Bestell-Nr.
Ordering-No.

Polzahl Contacts	Anschlussart Termination	Kabeldurchlass (mm) Cable outlet (mm)	Bestell-Nr. Ordering-No.
3+PE	schrauben screw	8-10	99-0209-110-04
6+PE	löten solder	8-10	99-0213-110-07
6+PE	schrauben screw	8-10	99-0217-110-07
6+PE	crimpen crimp	8-10	99-0201-110-07

Polzahl Contacts	Anschlussart Termination	Kabeldurchlass (mm) Cable outlet (mm)	Bestell-Nr. Ordering-No.
3+PE	schrauben screw	8-10	99-4221-110-04
6+PE	löten solder	8-10	99-4225-110-07
6+PE	schrauben screw	8-10	99-4217-110-07
6+PE	crimpen crimp	8-10	99-4201-110-07

Technische Daten
Specifications

Polzahl	3+PE	6+PE	6+PE	6+PE	Number of contacts
Steckverbinder Verriegelung	schrauben/screw				Connector locking system
Anschlussart	schrauben/screw	löten/solder	schrauben/screw	crimpen/crimp	Termination
Anschlussquerschnitt	0,5-2,5 mm ² (AWG 20-14)	max. 0,75 mm ² (max. AWG 18)	0,34-1,5 mm ² (AWG 22-16)	0,14-1,5 mm ² (AWG 26-16)	Wire gauge
Kabeldurchlass	8-10 mm				Cable outlet
Schutzart	IP67				Degree of protection
Mechanische Lebensdauer	> 500 Steckzyklen/> 500 mating cycles				Mechanical operation
Obere Grenztemperatur	+ 100 °C				Upper temperature
Untere Grenztemperatur	- 40 °C				Lower temperature
Bemessungsspannung	400 V (600 V UL)		250 V		Rated voltage
Bemessungs-Stoßspannung	6000 V		4000 V		Rated impulse voltage
Verschmutzungsgrad	3				Pollution degree
Überspannungskategorie	III				Overvoltage categorie
Isolierstoffgruppe	III				Material group
Bemessungsstrom (40°C)	16 A (12 A UL)		10 A (8 A UL)		Rated current (40 °C)
Durchgangswiderstand	≤ 5 mΩ				Contact resistance
Material Kontakt	CuZn (Messing/brass)				Material of contact
Kontaktoberfläche	Ag (Silber/silver)				Contact plating
Material Kontaktkörper	PBT (UL 94 V-0)				Material of contact body
Material Gehäuse	PBT (UL 94 V-0)				Material of housing

Leistungs Steckverbinder Serie 692 - 693

Power connectors series 692 - 693

Bezeichnung
Description

 Kabelstecker, PG13,5
Male cable connector, PG13,5
Abbildung
Figure

 Crimpkontakte siehe Seite 27.
Crimp contacts see page 27.

 Kabelstecker, PG13,5 mit VDE, SEV, UL Zulassung
Male cable connector, PG13,5 with VDE, SEV, UL approval

 Crimpkontakte siehe Seite 27.
Crimp contacts see page 27.

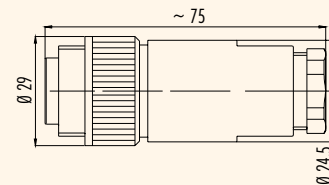
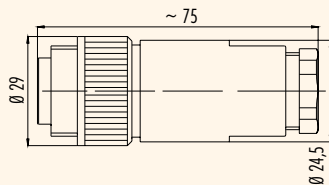
Maßzeichnung
Drawing

Bestell-Nr.
Ordering-No.

Polzahl Contacts	Anschlussart Termination	Kabeldurchlass (mm) Cable outlet (mm)	Bestell-Nr. Ordering-No.	Polzahl Contacts	Anschlussart Termination	Kabeldurchlass (mm) Cable outlet (mm)	Bestell-Nr. Ordering-No.
3+PE	schrauben screw	10-12	99-0209-15-04	3+PE	schrauben screw	10-12	99-4221-14-04
6+PE	löten solder	10-12	99-0213-15-07	6+PE	löten solder	10-12	99-4225-14-07
6+PE	schrauben screw	10-12	99-0217-15-07	6+PE	schrauben screw	10-12	99-4217-14-07
6+PE	crimpen crimp	10-12	99-0201-15-07	6+PE	crimpen crimp	10-12	99-4201-14-07

Technische Daten
Specifications

Polzahl	3+PE	6+PE	6+PE	6+PE	Number of contacts
Steckverbinder Verriegelung	schrauben/screw				Connector locking system
Anschlussart	schrauben/screw	löten/solder	schrauben/screw	crimpen/crimp	Termination
Anschlussquerschnitt	0,5-2,5 mm ² (AWG 20-14)	max. 0,75 mm ² (max. AWG 18)	0,34-1,5 mm ² (AWG 22-16)	0,14-1,5 mm ² (AWG 26-16)	Wire gauge
Kabeldurchlass	10-12 mm				Cable outlet
Schutzart	IP67				Degree of protection
Mechanische Lebensdauer	> 500 Steckzyklen/> 500 mating cycles				Mechanical operation
Obere Grenztemperatur	+ 100 °C				Upper temperature
Untere Grenztemperatur	- 40 °C				Lower temperature
Bemessungsspannung	400 V (600 V UL)		250 V		Rated voltage
Bemessungs-Stoßspannung	6000 V		4000 V		Rated impulse voltage
Verschmutzungsgrad	3				Pollution degree
Überspannungskategorie	III				Overvoltage categorie
Isolierstoffgruppe	III				Material group
Bemessungsstrom (40 °C)	16 A (12 A UL)		10 A (8 A UL)		Rated current (40 °C)
Durchgangswiderstand	≤ 5 mΩ				Contact resistance
Material Kontakt	CuZn (Messing/brass)				Material of contact
Kontaktoberfläche	Ag (Silber/silver)				Contact plating
Material Kontaktkörper	PBT (UL 94 V-0)				Material of contact body
Material Gehäuse	PBT (UL 94 V-0)				Material of housing

Leistungs Steckverbinder Serie 692 - 693
Power connectors series 692 - 693

Bezeichnung
Description

Kabelstecker, PG16
Male cable connector, PG16

Kabelstecker, PG16 mit VDE, SEV, UL Zulassung
Male cable connector, PG16 with VDE, SEV, UL approval

Abbildung
Figure

Crimpkontakte siehe Seite 27.
Crimp contacts see page 27.

Crimpkontakte siehe Seite 27.
Crimp contacts see page 27.



Maßzeichnung
Drawing

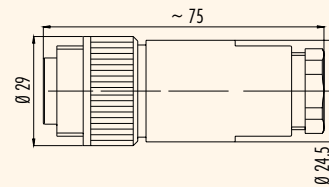
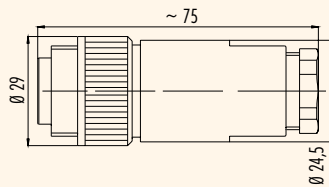

Bestell-Nr.
Ordering-No.

Polzahl Contacts	Anschlussart Termination	Kabeldurchlass (mm) Cable outlet (mm)	Bestell-Nr. Ordering-No.
3+PE	schrauben screw	12-14	99-0209-160-04
6+PE	löten solder	12-14	99-0213-160-07
6+PE	schrauben screw	12-14	99-0217-160-07
6+PE	crimpen crimp	12-14	99-0201-160-07

Polzahl Contacts	Anschlussart Termination	Kabeldurchlass (mm) Cable outlet (mm)	Bestell-Nr. Ordering-No.
3+PE	schrauben screw	12-14	99-4221-160-04
6+PE	löten solder	12-14	99-4225-160-07
6+PE	schrauben screw	12-14	99-4217-160-07
6+PE	crimpen crimp	12-14	99-4201-160-07

Technische Daten
Specifications

Polzahl	3+PE	6+PE	6+PE	6+PE	Number of contacts
Steckverbinder Verriegelung	schrauben/screw				Connector locking system
Anschlussart	schrauben/screw	löten/solder	schrauben/screw	crimpen/crimp	Termination
Anschlussquerschnitt	0,5-2,5 mm ² (AWG 20-14)	max. 0,75 mm ² (max. AWG 18)	0,34-1,5 mm ² (AWG 22-16)	0,14-1,5 mm ² (AWG 26-16)	Wire gauge
Kabeldurchlass	12-14 mm				Cable outlet
Schutzart	IP67				Degree of protection
Mechanische Lebensdauer	> 500 Steckzyklen/> 500 mating cycles				Mechanical operation
Obere Grenztemperatur	+ 100 °C				Upper temperature
Untere Grenztemperatur	- 40 °C				Lower temperature
Bemessungsspannung	400 V (600 V UL)		250 V		Rated voltage
Bemessungs-Stoßspannung	6000 V		4000 V		Rated impulse voltage
Verschmutzungsgrad	3				Pollution degree
Überspannungskategorie	III				Overvoltage categorie
Isolierstoffgruppe	III				Material group
Bemessungsstrom (40°C)	16 A (12 A UL)		10 A (8 A UL)		Rated current (40 °C)
Durchgangswiderstand	≤ 5 mΩ				Contact resistance
Material Kontakt	CuZn (Messing/brass)				Material of contact
Kontaktoberfläche	Ag (Silber/silver)				Contact plating
Material Kontaktkörper	PBT (UL 94 V-0)				Material of contact body
Material Gehäuse	PBT (UL 94 V-0)				Material of housing

Leistung Steckverbinder Serie 692 - 693

Power connectors series 692 - 693

Bezeichnung
Description

Winkelstecker, PG9
Male angled connector, PG9

Winkelstecker, PG9 mit VDE, SEV, UL Zulassung
Male angled connector, PG9 with VDE, SEV, UL approval

Abbildung
Figure

Crimpkontakte siehe Seite 27.
Crimp contacts see page 27.

Crimpkontakte siehe Seite 27.
Crimp contacts see page 27.



Maßzeichnung
Drawing

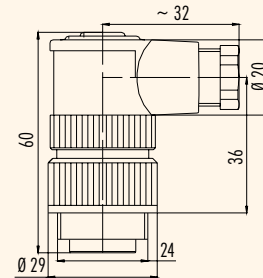
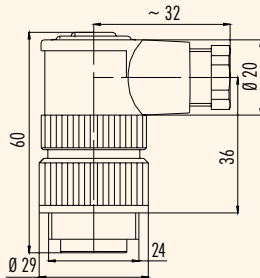

Bestell-Nr.
Ordering-No.

Polzahl Contacts	Anschlussart Termination	Kabeldurchlass (mm) Cable outlet (mm)	Bestell-Nr. Ordering-No.
3+PE	schrauben screw	6-8	99-0209-70-04
6+PE	löten solder	6-8	99-0213-70-07
6+PE	schrauben screw	6-8	99-0217-70-07
6+PE	crimpen crimp	6-8	99-0201-70-07

Polzahl Contacts	Anschlussart Termination	Kabeldurchlass (mm) Cable outlet (mm)	Bestell-Nr. Ordering-No.
3+PE	schrauben screw	6-8	99-4221-70-04
6+PE	löten solder	6-8	99-4225-70-07
6+PE	schrauben screw	6-8	99-4217-70-07
6+PE	crimpen crimp	6-8	99-4201-70-07

Technische Daten
Specifications

Polzahl	3+PE	6+PE	6+PE	6+PE	Number of contacts
Steckverbinder Verriegelung	schrauben/screw				Connector locking system
Anschlussart	schrauben/screw	löten/solder	schrauben/screw	crimpen/crimp	Termination
Anschlussquerschnitt	0,5-2,5 mm ² (AWG 20-14)	max. 0,75 mm ² (max. AWG 18)	0,34-1,5 mm ² (AWG 22-16)	0,14-1,5 mm ² (AWG 26-16)	Wire gauge
Kabeldurchlass	6-8 mm				Cable outlet
Schutzart	IP67 ¹⁾				Degree of protection
Mechanische Lebensdauer	> 500 Steckzyklen/> 500 mating cycles				Mechanical operation
Obere Grenztemperatur	+ 100 °C				Upper temperature
Untere Grenztemperatur	- 40 °C				Lower temperature
Bemessungsspannung	400 V (600 V UL)	250 V		4000 V	Rated voltage
Bemessungsstoßspannung	6000 V	4000 V			Rated impulse voltage
Verschmutzungsgrad	3				Pollution degree
Überspannungskategorie	III				Overvoltage categorie
Isolierstoffgruppe	III				Material group
Bemessungsstrom (40°C)	16 A (12 A UL)	10 A (8 A UL)			Rated current (40 °C)
Durchgangswiderstand	≤ 5 mΩ				Contact resistance
Material Kontakt	CuZn (Messing/brass)				Material of contact
Kontaktoberfläche	Ag (Silber/silver)				Contact plating
Material Kontaktkörper	PBT (UL 94 V-0)				Material of contact body
Material Gehäuse	PBT (UL 94 V-0)				Material of housing

Leistungs Steckverbinder Serie 692 - 693
Power connectors series 692 - 693
Bezeichnung
Description
Abbildung
Figure
Kabelstecker
Male cable connector

 Technische Kabeldaten siehe Seite 24.
Specifications of cable see page 24.

Winkelstecker
Male angled connector

 Technische Kabeldaten siehe Seite 24.
Specifications of cable see page 24.

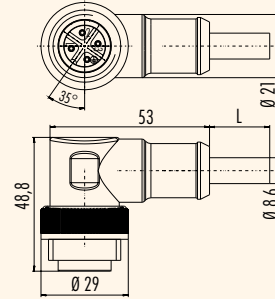
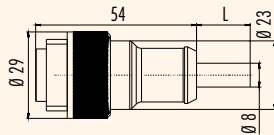
Maßzeichnung
Drawing

Bestell-Nr.
Ordering-No.

Polzahl Contacts	Kabellänge (m) Cable length (m)	Bestell-Nr. Ordering-No.	Polzahl Contacts	Kabellänge (m) Cable length (m)	Bestell-Nr. Ordering-No.
3+PE 4 x 1,5 PVC	2	79-0231-20-04	3+PE 4 x 1,5 PVC	2	79-0233-20-04
6+PE 7 x 0,75 PVC		79-0235-20-07	6+PE 7 x 0,75 PVC		79-0237-20-07

Technische Daten
Specifications

Polzahl	3+PE	6+PE	Number of contacts
Steckverbinder Verriegelung	schrauben/screw		Connector locking system
Anschlussart	crimpen, am Kabel angespritzt/crimp, moulded		Termination
Anschlussquerschnitt	1,5 mm ² (AWG 16)	0,75 mm ² (AWG 18)	Wire gauge
Kabeldurchlass	-		Cable outlet
Schutzart	IP67		Degree of protection
Mechanische Lebensdauer	> 500 Steckzyklen/> 500 mating cycles		Mechanical operation
Obere Grenztemperatur	+ 80 °C		Upper temperature
Untere Grenztemperatur	- 25 °C		Lower temperature
Bemessungsspannung	400 V	250 V	Rated voltage
Bemessungs-Stoßspannung	6000 V	4000 V	Rated impulse voltage
Verschmutzungsgrad	3		Pollution degree
Überspannungskategorie	III		Overvoltage categorie
Isolierstoffgruppe	III		Material group
Bemessungsstrom (40°C)	16 A	8 A	Rated current (40 °C)
Durchgangswiderstand	≤ 5 mΩ		Contact resistance
Material Kontakt	CuZn (Messing/brass)		Material of contact
Kontaktoberfläche	Ag (Silber/silver)		Contact plating
Material Kontaktkörper	PA 12		Material of contact body
Material Gehäuse	PUR		Material of housing

Leistungs Steckverbinder Serie 692 - 693
Power connectors series 692 - 693

Bezeichnung
Description

Kabeldose, PG9
Female cable connector, PG9

Kabeldose, PG9 mit VDE, SEV, UL Zulassung
Female cable connector, PG9 with VDE, SEV, UL approval

Abbildung
Figure

Crimpkontakte siehe Seite 27.
Crimp contacts see page 27.

Crimpkontakte siehe Seite 27.
Crimp contacts see page 27.



Maßzeichnung
Drawing

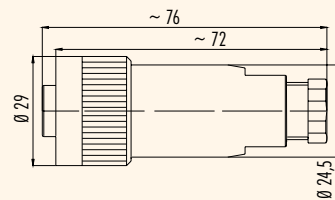
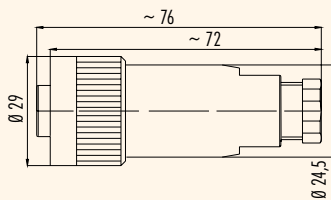

Bestell-Nr.
Ordering-No.

Polzahl Contacts	Anschlussart Termination	Kabeldurchlass (mm) Cable outlet (mm)	Bestell-Nr. Ordering-No.
3+PE	schrauben screw	6-9,5	99-0210-00-04
6+PE	löten solder	6-9,5	99-0214-00-07
6+PE	schrauben screw	6-8	99-0218-00-07
6+PE	crimpen crimp	6-8	99-0202-00-07

Polzahl Contacts	Anschlussart Termination	Kabeldurchlass (mm) Cable outlet (mm)	Bestell-Nr. Ordering-No.
3+PE	schrauben screw	6-9,5	99-4222-00-04
6+PE	löten solder	6-9,5	99-4226-00-07
6+PE	schrauben screw	6-8	99-4218-00-07
6+PE	crimpen crimp	6-8	99-4202-00-07

Technische Daten
Specifications

Polzahl	3+PE	6+PE	6+PE	6+PE	Number of contacts
Steckverbinder Verriegelung	schrauben/screw				Connector locking system
Anschlussart	schrauben/screw	löten/solder	schrauben/screw	crimpen/crimp	Termination
Anschlussquerschnitt	0,5-2,5 mm ² (AWG 20-14)	max. 0,75 mm ² (max. AWG 18)	0,34-1,5 mm ² (AWG 22-16)	0,14-1,5 mm ² (AWG 26-16)	Wire gauge
Kabeldurchlass	6-8 mm, 6-9,5 mm				Cable outlet
Schutzart	IP67 ¹⁾				Degree of protection
Mechanische Lebensdauer	> 500 Steckzyklen/> 500 mating cycles				Mechanical operation
Obere Grenztemperatur	+ 100 °C				Upper temperature
Untere Grenztemperatur	- 40 °C				Lower temperature
Bemessungsspannung	400 V (600 V UL)		250 V		Rated voltage
Bemessungs-Stoßspannung	6000 V		4000 V		Rated impulse voltage
Verschmutzungsgrad	3				Pollution degree
Überspannungskategorie	III				Overvoltage categorie
Isolierstoffgruppe	III				Material group
Bemessungsstrom (40 °C)	16 A (12 A UL)		10 A (8 A UL)		Rated current (40 °C)
Durchgangswiderstand	≤ 5 mΩ				Contact resistance
Material Kontakt	CuSn (Bronze/bronze), CuZn (Messing/brass)				Material of contact
Kontaktoberfläche	Ag (Silber/silver)				Contact plating
Material Kontaktkörper	PBT (UL 94 V-0)				Material of contact body
Material Gehäuse	PBT (UL 94 V-0)				Material of housing

Leistungs Steckverbinder Serie 692 - 693
Power connectors series 692 - 693
Bezeichnung
Description
Abbildung
Figure
Kabeldose, PG11
Female cable connector, PG11
Crimpkontakte siehe Seite 27.
Crimp contacts see page 27.

Kabeldose, PG11 mit VDE, SEV, UL Zulassung
Female cable connector, PG11 with VDE, SEV, UL approval
Crimpkontakte siehe Seite 27.
Crimp contacts see page 27.

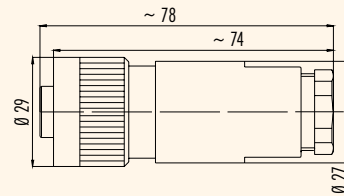
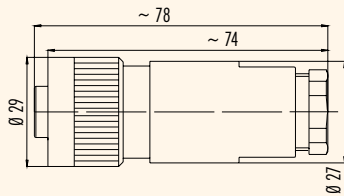
Maßzeichnung
Drawing

Bestell-Nr.
Ordering-No.

Polzahl Contacts	Anschlussart Termination	Kabeldurchlass (mm) Cable outlet (mm)	Bestell-Nr. Ordering-No.	Polzahl Contacts	Anschlussart Termination	Kabeldurchlass (mm) Cable outlet (mm)	Bestell-Nr. Ordering-No.
3+PE	schrauben screw	8-10	99-0210-110-04	3+PE	schrauben screw	8-10	99-4222-110-04
6+PE	löten solder	8-10	99-0214-110-07	6+PE	löten solder	8-10	99-4226-110-07
6+PE	schrauben screw	8-10	99-0218-110-07	6+PE	schrauben screw	8-10	99-4218-110-07
6+PE	crimpen crimp	8-10	99-0202-110-07	6+PE	crimpen crimp	8-10	99-4202-110-07

Technische Daten
Specifications

Polzahl	3+PE	6+PE	6+PE	6+PE	Number of contacts
Steckverbinder Verriegelung	schrauben/screw				Connector locking system
Anschlussart	schrauben/screw	löten/solder	schrauben/screw	crimpen/crimp	Termination
Anschlussquerschnitt	0,5-2,5 mm ² (AWG 20-14)	max. 0,75 mm ² (max. AWG 18)	0,34-1,5 mm ² (AWG 22-16)	0,14-1,5 mm ² (AWG 26-16)	Wire gauge
Kabeldurchlass	8-10 mm				Cable outlet
Schutzart	IP67				Degree of protection
Mechanische Lebensdauer	> 500 Steckzyklen/> 500 mating cycles				Mechanical operation
Obere Grenztemperatur	+ 100 °C				Upper temperature
Untere Grenztemperatur	- 40 °C				Lower temperature
Bemessungsspannung	400 V (600 V UL)		250 V		Rated voltage
Bemessungs-Stoßspannung	6000 V		4000 V		Rated impulse voltage
Verschmutzungsgrad	3				Pollution degree
Überspannungskategorie	III				Overvoltage categorie
Isolierstoffgruppe	III				Material group
Bemessungsstrom (40°C)	16 A (12 A UL)		10 A (8 A UL)		Rated current (40 °C)
Durchgangswiderstand	≤ 5 mΩ				Contact resistance
Material Kontakt	CuSn (Bronze/bronce), CuZn (Messing/brass)				Material of contact
Kontaktoberfläche	Ag (Silber/silver)				Contact plating
Material Kontaktkörper	PBT (UL 94 V-0)				Material of contact body
Material Gehäuse	PBT (UL 94 V-0)				Material of housing

Leistungs Steckverbinder Serie 692 - 693

Power connectors series 692 - 693

Bezeichnung
Description

 Kabeldose, PG13,5
Female cable connector, PG13,5

 Kabeldose, PG13,5 mit VDE, SEV, UL Zulassung
Female cable connector, PG13,5 with VDE, SEV, UL approval
Abbildung
Figure

 Crimpkontakte siehe Seite 27.
Crimp contacts see page 27.

 Crimpkontakte siehe Seite 27.
Crimp contacts see page 27.

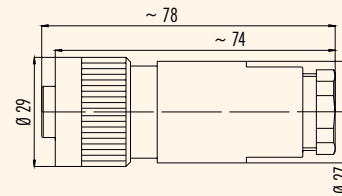
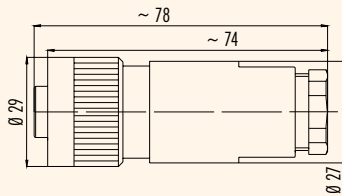
Maßzeichnung
Drawing

Bestell-Nr.
Ordering-No.

Polzahl Contacts	Anschlussart Termination	Kabeldurchlass (mm) Cable outlet (mm)	Bestell-Nr. Ordering-No.	Polzahl Contacts	Anschlussart Termination	Kabeldurchlass (mm) Cable outlet (mm)	Bestell-Nr. Ordering-No.
3+PE	schrauben screw	10-12	99-0210-15-04	3+PE	schrauben screw	10-12	99-4222-14-04
6+PE	löten solder	10-12	99-0214-15-07	6+PE	löten solder	10-12	99-4226-14-07
6+PE	schrauben screw	10-12	99-0218-15-07	6+PE	schrauben screw	10-12	99-4218-14-07
6+PE	crimpen crimp	10-12	99-0202-15-07	6+PE	crimpen crimp	10-12	99-4202-14-07

Technische Daten
Specifications

Polzahl	3+PE	6+PE	6+PE	6+PE	Number of contacts
Steckverbinder Verriegelung	schrauben/screw				Connector locking system
Anschlussart	schrauben/screw	löten/solder	schrauben/screw	crimpen/crimp	Termination
Anschlussquerschnitt	0,5-2,5 mm ² (AWG 20-14)	max. 0,75 mm ² (max. AWG 18)	0,34-1,5 mm ² (AWG 22-16)	0,14-1,5 mm ² (AWG 26-16)	Wire gauge
Kabeldurchlass	10-12 mm				Cable outlet
Schutzart	IP67				Degree of protection
Mechanische Lebensdauer	> 500 Steckzyklen/> 500 mating cycles				Mechanical operation
Obere Grenztemperatur	+ 100 °C				Upper temperature
Untere Grenztemperatur	- 40 °C				Lower temperature
Bemessungsspannung	400 V (600 V UL)		250 V		Rated voltage
Bemessungs-Stoßspannung	6000 V		4000 V		Rated impulse voltage
Verschmutzungsgrad	3				Pollution degree
Überspannungskategorie	III				Overvoltage categorie
Isolierstoffgruppe	III				Material group
Bemessungsstrom (40 °C)	16 A (12 A UL)		10 A (8 A UL)		Rated current (40 °C)
Durchgangswiderstand	≤ 5 mΩ				Contact resistance
Material Kontakt	CuSn (Bronze/bronze), CuZn (Messing/brass)				Material of contact
Kontaktoberfläche	Ag (Silber/silver)				Contact plating
Material Kontaktkörper	PBT (UL 94 V-0)				Material of contact body
Material Gehäuse	PBT (UL 94 V-0)				Material of housing

Leistungs Steckverbinder Serie 692 - 693
Power connectors series 692 - 693
Bezeichnung
Description
Abbildung
Figure
Kabeldose, PG16
Female cable connector, PG16
Crimpkontakte siehe Seite 27.
Crimp contacts see page 27.

Kabeldose, PG16 mit VDE, SEV, UL Zulassung
Female cable connector, PG16 with VDE, SEV, UL approval
Crimpkontakte siehe Seite 27.
Crimp contacts see page 27.

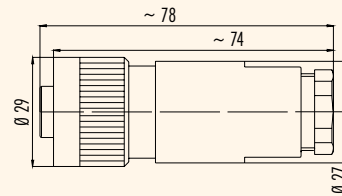
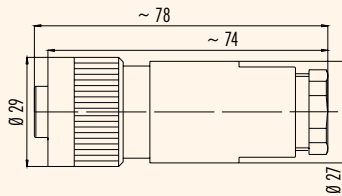
Maßzeichnung
Drawing

Bestell-Nr.
Ordering-No.

Polzahl Contacts	Anschlussart Termination	Kabeldurchlass (mm) Cable outlet (mm)	Bestell-Nr. Ordering-No.	Polzahl Contacts	Anschlussart Termination	Kabeldurchlass (mm) Cable outlet (mm)	Bestell-Nr. Ordering-No.
3+PE	schrauben <i>screw</i>	12-14	99-0210-160-04	3+PE	schrauben <i>screw</i>	12-14	99-4222-160-04
6+PE	löten <i>solder</i>	12-14	99-0214-160-07	6+PE	löten <i>solder</i>	12-14	99-4226-160-07
6+PE	schrauben <i>screw</i>	12-14	99-0218-160-07	6+PE	schrauben <i>screw</i>	12-14	99-4218-160-07
6+PE	crimpen <i>crimp</i>	12-14	99-0202-160-07	6+PE	crimpen <i>crimp</i>	12-14	99-4202-160-07

Technische Daten
Specifications

Polzahl	3+PE	6+PE	6+PE	6+PE	Number of contacts
Steckverbinder Verriegelung	schrauben/screw				Connector locking system
Anschlussart	schrauben/screw	löten/solder	schrauben/screw	crimpen/crimp	Termination
Anschlussquerschnitt	0,5-2,5 mm ² (AWG 20-14)	max. 0,75 mm ² (max. AWG 18)	0,34-1,5 mm ² (AWG 22-16)	0,14-1,5 mm ² (AWG 26-16)	Wire gauge
Kabeldurchlass	12-14 mm				Cable outlet
Schutzart	IP67				Degree of protection
Mechanische Lebensdauer	> 500 Steckzyklen/> 500 mating cycles				Mechanical operation
Obere Grenztemperatur	+ 100 °C				Upper temperature
Untere Grenztemperatur	- 40 °C				Lower temperature
Bemessungsspannung	400 V (600 V UL)		250 V		Rated voltage
Bemessungs-Stoßspannung	6000 V		4000 V		Rated impulse voltage
Verschmutzungsgrad	3				Pollution degree
Überspannungskategorie	III				Overvoltage categorie
Isolierstoffgruppe	III				Material group
Bemessungsstrom (40°C)	16 A (12 A UL)		10 A (8 A UL)		Rated current (40 °C)
Durchgangswiderstand	≤ 5 mΩ				Contact resistance
Material Kontakt	CuSn (Bronze/bronze), CuZn (Messing/brass)				Material of contact
Kontaktoberfläche	Ag (Silber/silver)				Contact plating
Material Kontaktkörper	PBT (UL 94 V-0)				Material of contact body
Material Gehäuse	PBT (UL 94 V-0)				Material of housing

Leistungs Steckverbinder Serie 692 - 693

Power connectors series 692 - 693

Bezeichnung
Description

Winkeldose, PG9
Female angled connector, PG9

Abbildung
Figure

Crimpkontakte siehe Seite 27.
Crimp contacts see page 27.



Winkeldose, PG9 mit VDE, SEV, UL Zulassung
Female angled connector, PG9 with VDE, SEV, UL approval

Crimpkontakte siehe Seite 27.
Crimp contacts see page 27.



Maßzeichnung
Drawing

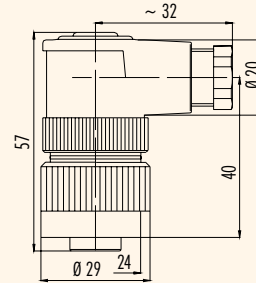
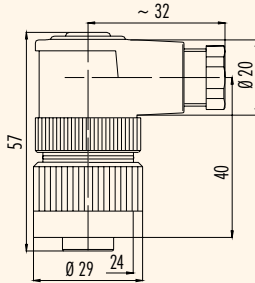

Bestell-Nr.
Ordering-No.

Polzahl Contacts	Anschlussart Termination	Kabeldurchlass (mm) Cable outlet (mm)	Bestell-Nr. Ordering-No.
3+PE	schrauben screw	6-8	99-0210-70-04
6+PE	löten solder	6-8	99-0214-70-07
6+PE	schrauben screw	6-8	99-0218-70-07
6+PE	crimpen crimp	6-8	99-0202-70-07

Polzahl Contacts	Anschlussart Termination	Kabeldurchlass (mm) Cable outlet (mm)	Bestell-Nr. Ordering-No.
3+PE	schrauben screw	6-8	99-4222-70-04
6+PE	löten solder	6-8	99-4226-70-07
6+PE	schrauben screw	6-8	99-4218-70-07
6+PE	crimpen crimp	6-8	99-4202-70-07

Technische Daten
Specifications

Polzahl	3+PE	6+PE	6+PE	6+PE	Number of contacts
Steckverbinder Verriegelung	schrauben/screw				Connector locking system
Anschlussart	schrauben/screw	löten/solder	schrauben/screw	crimpen/crimp	Termination
Anschlussquerschnitt	0,5-2,5 mm ² (AWG 20-14)	max. 0,75 mm ² (max. AWG 18)	0,34-1,5 mm ² (AWG 22-16)	0,14-1,5 mm ² (AWG 26-16)	Wire gauge
Kabeldurchlass	6-8 mm				Cable outlet
Schutzart	IP67 ¹⁾				Degree of protection
Mechanische Lebensdauer	> 500 Steckzyklen/> 500 mating cycles				Mechanical operation
Obere Grenztemperatur	+ 100 °C				Upper temperature
Untere Grenztemperatur	- 40 °C				Lower temperature
Bemessungsspannung	400 V (600 V UL)		250 V		Rated voltage
Bemessungs-Stoßspannung	6000 V		4000 V		Rated impulse voltage
Verschmutzungsgrad	3				Pollution degree
Überspannungskategorie	III				Overvoltage categorie
Isolierstoffgruppe	III				Material group
Bemessungsstrom (40 °C)	16 A (12 A UL)		10 A (8 A UL)		Rated current (40 °C)
Durchgangswiderstand	≤ 5 mΩ				Contact resistance
Material Kontakt	CuSn (Bronze/bronze), CuZn (Messing/brass)				Material of contact
Kontaktoberfläche	Ag (Silber/silver)				Contact plating
Material Kontaktkörper	PBT (UL 94 V-0)				Material of contact body
Material Gehäuse	PBT (UL 94 V-0)				Material of housing

Leistungs Steckverbinder Serie 692 - 693
Power connectors series 692 - 693
Bezeichnung
Description
Abbildung
Figure
Kabeldose
Female cable connector

 Technische Kabeldaten siehe Seite 24.
Specifications of cable see page 24.

Winkeldose
Female angled connector

 Technische Kabeldaten siehe Seite 24.
Specifications of cable see page 24.

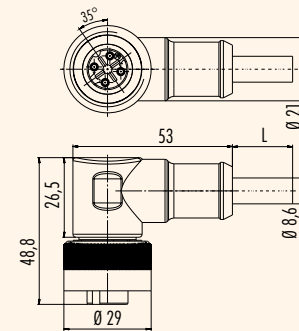
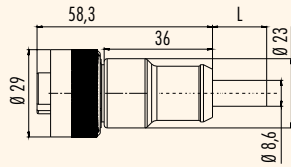
Maßzeichnung
Drawing

Bestell-Nr.
Ordering-No.

Polzahl Contacts	Kabellänge (m) Cable length (m)	Bestell-Nr. Ordering-No.
3+PE 4 x 1,5 PVC	2	79-0232-20-04
6+PE 7 x 0,75 PVC		79-0236-20-07

Polzahl Contacts	Kabellänge (m) Cable length (m)	Bestell-Nr. Ordering-No.
3+PE 4 x 1,5 PVC	2	79-0234-20-04
6+PE 7 x 0,75 PVC		79-0238-20-07

Technische Daten
Specifications

Polzahl	3+PE	6+PE	Number of contacts
Steckverbinder Verriegelung	schrauben/screw		Connector locking system
Anschlussart	crimpen, am Kabel angespritzt/crimp, moulded		Termination
Anschlussquerschnitt	1,5 mm ² (AWG 16)	0,75 mm ² (AWG 18)	Wire gauge
Kabeldurchlass	-		Cable outlet
Schutzart	IP67		Degree of protection
Mechanische Lebensdauer	> 500 Steckzyklen/> 500 mating cycles		Mechanical operation
Obere Grenztemperatur	+ 80 °C		Upper temperature
Untere Grenztemperatur	- 25 °C		Lower temperature
Bemessungsspannung	400 V	250 V	Rated voltage
Bemessungs-Stoßspannung	6000 V	4000 V	Rated impulse voltage
Verschmutzungsgrad	3		Pollution degree
Überspannungskategorie	III		Overvoltage categorie
Isolierstoffgruppe	III		Material group
Bemessungsstrom (40 °C)	16 A	8 A	Rated current (40 °C)
Durchgangswiderstand	≤ 5 mΩ		Contact resistance
Material Kontakt	CuZn (Messing/brass)		Material of contact
Kontaktoberfläche	Ag (Silber/silver)		Contact plating
Material Kontaktkörper	PA 12		Material of contact body
Material Gehäuse	PUR		Material of housing

Leistungs Steckverbinder Serie 692 - 693

Power connectors series 692 - 693

Bezeichnung
Description

Flanschstecker 3+PE, Schraubanschluss
Male socket 3+PE, screw termination

Flanschstecker 3+PE, Schraubanschluss,
VDE, SEV, UL Zulassung
Male socket 3+PE, screw termination
VDE, SEV, UL approval

Abbildung
Figure



Maßzeichnung
Drawing

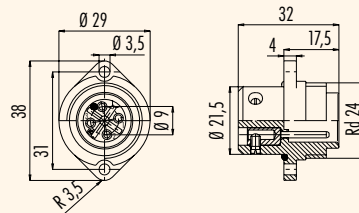
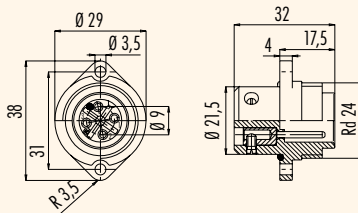

Bestell-Nr.
Ordering-No.

Polzahl Contacts	Bestell-Nr. Ordering-No.
3+PE	09-0211-00-04

Polzahl Contacts	Bestell-Nr. Ordering-No.
3+PE	09-4223-00-04

Technische Daten
Specifications

Polzahl	3+PE	Number of contacts
Steckverbinder Verriegelung	Schrauben/screw	Connector locking system
Anschlussart	Schrauben/screw	Termination
Anschlussquerschnitt	0,5-2,5 mm ² (AWG 20-14)	Wire gauge
Kabeldurchlass	-	Cable outlet
Schutzart	IP67	Degree of protection
Mechanische Lebensdauer	> 500 Steckzyklen/> 500 mating cycles	Mechanical operation
Obere Grenztemperatur	+ 100 °C	Upper temperature
Untere Grenztemperatur	- 40 °C	Lower temperature
Bemessungsspannung	400 V (600 V UL)	Rated voltage
Bemessungs-Stoßspannung	6000 V	Rated impulse voltage
Verschmutzungsgrad	3	Pollution degree
Überspannungskategorie	III	Overvoltage categorie
Isolierstoffgruppe	III	Material group
Bemessungsstrom (40°C)	16 A (12 A UL)	Rated current (40 °C)
Durchgangswiderstand	≤ 5 mΩ	Contact resistance
Material Kontakt	CuZn (Messing/brass)	Material of contact
Kontaktoberfläche	Ag (Silber/silver)	Contact plating
Material Kontaktkörper	PBT	Material of contact body
Material Gehäuse	-	Material of housing

Leistungs Steckverbinder Serie 692 - 693
Power connectors series 692 - 693

Bezeichnung
Description

Flanschstecker 6+PE, Lötanschluss
Male socket 6+PE, solder termination

Flanschstecker 6+PE, Lötanschluss
VDE, SEV, UL Zulassung
Male socket 6+PE, solder termination
VDE, SEV, UL approval

Abbildung
Figure



Maßzeichnung
Drawing

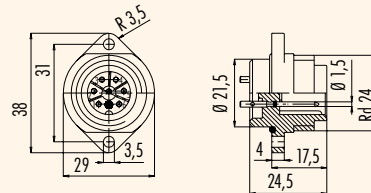
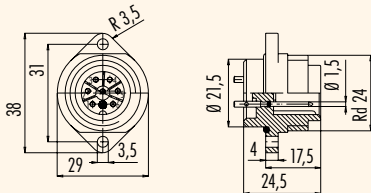

Bestell-Nr.
Ordering-No.

Polzahl Contacts	Bestell-Nr. Ordering-No.
6+PE	09-0215-00-07

Polzahl Contacts	Bestell-Nr. Ordering-No.
6+PE	09-4227-00-07

Technische Daten
Specifications

Polzahl	6+PE	Number of contacts
Steckverbinder Verriegelung	Schrauben/Screw	Connector locking system
Anschlussart	Löten/Solder	Termination
Anschlussquerschnitt	max. 0,75 mm ² (max. AWG 20)	Wire gauge
Kabeldurchlass	-	Cable outlet
Schutzart	IP67	Degree of protection
Mechanische Lebensdauer	> 500 Steckzyklen / > 500 mating cycles	Mechanical operation
Obere Grenztemperatur	+ 100 °C	Upper temperature
Untere Grenztemperatur	- 40 °C	Lower temperature
Bemessungsspannung	250 V	Rated voltage
Bemessungsstoßspannung	4000 V	Rated impulse voltage
Verschmutzungsgrad	3	Pollution degree
Überspannungskategorie	III	Overvoltage category
Isolierstoffgruppe	III	Material group
Bemessungsstrom (40°C)	10 A (8 A UL)	Rated current (40 °C)
Durchgangswiderstand	≤ 5 mΩ	Contact resistance
Material Kontakt	CuZn (Messing/brass)	Material at contact
Kontaktoberfläche	Ag (Silber/silver)	Contact plating
Material Kontaktkörper	PBT	Material of contact body
Material Gehäuse	-	Material of housing

Leistungs Steckverbinder Serie 692 - 693

Power connectors series 692 - 693

Bezeichnung
Description

Flanschstecker 6+PE, Schraubanschluss
Male socket 6+PE, screw termination

Flanschstecker 6+PE, Schraubanschluss
VDE, SEV, UL Zulassung
Male socket 6+PE, screw termination
VDE, SEV, UL approval

Abbildung
Figure



Maßzeichnung
Drawing

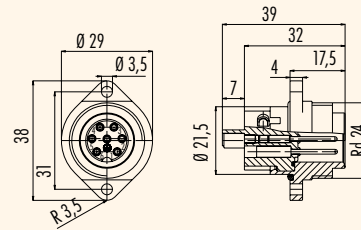
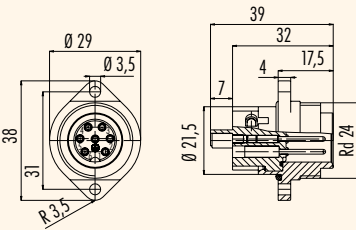

Bestell-Nr.
Ordering-No.

Polzahl Contacts	Bestell-Nr. Ordering-No.
6+PE	09-0219-00-07

Polzahl Contacts	Bestell-Nr. Ordering-No.
6+PE	09-4219-00-07

Technische Daten
Specifications

Polzahl	6+PE	Number of contacts
Steckverbinder Verriegelung	Schrauben/screw	Connector locking system
Anschlussart	Schrauben/screw	Termination
Anschlussquerschnitt	0,34-1,5 mm ² (AWG 22-16)	Wire gauge
Kabeldurchlass	-	Cable outlet
Schutzart	IP67	Degree of protection
Mechanische Lebensdauer	> 500 Steckzyklen/> 500 mating cycles	Mechanical operation
Obere Grenztemperatur	+ 100 °C	Upper temperature
Untere Grenztemperatur	- 40 °C	Lower temperature
Bemessungsspannung	250 V	Rated voltage
Bemessungs-Stoßspannung	4000 V	Rated impulse voltage
Verschmutzungsgrad	3	Pollution degree
Überspannungskategorie	III	Overvoltage categorie
Isolierstoffgruppe	III	Material group
Bemessungsstrom (40°C)	10 A (8 V UL)	Rated current (40 °C)
Durchgangswiderstand	≤ 5 mΩ	Contact resistance
Material Kontakt	CuZn (Messing/brass)	Material of contact
Kontaktoberfläche	Ag (Silber/silver)	Contact plating
Material Kontaktkörper	PBT	Material of contact body
Material Gehäuse	PA (UL 94 V-0)	Material of housing

Leistungs Steckverbinder Serie 692 - 693
Power connectors series 692 - 693

Bezeichnung Description	Flanschstecker 6+PE, Crimpschluss Male socket 6+PE, crimp termination	Flanschstecker 6+PE, Crimpschluss VDE, SEV, UL Zulassung Male socket 6+PE, crimp termination VDE, SEV, UL approval
Abbildung Figure	Crimpkontakte siehe Seite 27. Crimp contacts see page 27.	Crimpkontakte siehe Seite 27. Crimp contacts see page 27.
		

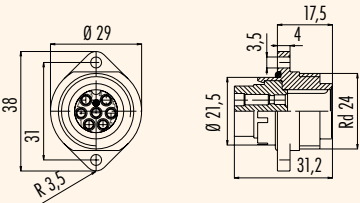
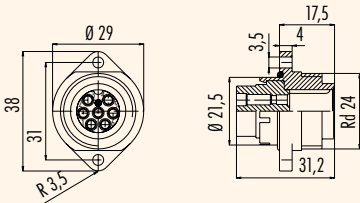
Maßzeichnung Drawing		
--------------------------------	--	---

Bestell-Nr. Ordering-No.	Polzahl Contacts	Bestell-Nr. Ordering-No.	Polzahl Contacts	Bestell-Nr. Ordering-No.
	6+PE	09-0203-00-07	6+PE	09-4203-00-07

Technische Daten
Specifications

Polzahl	6+PE	Number of contacts
Steckverbinder Verriegelung	schrauben/screw	Connector locking system
Anschlussart	crimpen/crimp	Termination
Anschlussquerschnitt	0,14-1,5 mm ² (AWG 26-16)	Wire gauge
Kabeldurchlass	-	Cable outlet
Schutzart	IP67	Degree of protection
Mechanische Lebensdauer	> 500 Steckzyklen/> 500 mating cycles	Mechanical operation
Obere Grenztemperatur	+ 100 °C	Upper temperature
Untere Grenztemperatur	- 40 °C	Lower temperature
Bemessungsspannung	250 V	Rated voltage
Bemessungs-Stoßspannung	4000 V	Rated impulse voltage
Verschmutzungsgrad	3	Pollution degree
Überspannungskategorie	III	Overvoltage categorie
Isolierstoffgruppe	III	Material group
Bemessungsstrom (40°C)	10 A (8 V UL)	Rated current (40 °C)
Durchgangswiderstand	-	Contact resistance
Material Kontakt	-	Material of contact
Kontaktoberfläche	-	Contact plating
Material Kontaktkörper	PBT	Material of contact body
Material Gehäuse	-	Material of housing

Leistungs Steckverbinder Serie 692 - 693

Power connectors series 692 - 693

Bezeichnung
Description

Flanschdose 3+PE, Schraubanschluss
Female socket 3+PE, screw termination

Flanschdose 3+PE, Schraubanschluss
VDE, SEV, UL Zulassung
Female socket 3+PE, screw termination
VDE, SEV, UL approval

Abbildung
Figure



Maßzeichnung
Drawing

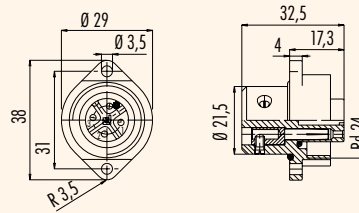
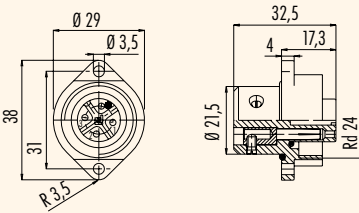

Bestell-Nr.
Ordering-No.

Polzahl Contacts	Bestell-Nr. Ordering-No.
3+PE	09-0212-00-04

Polzahl Contacts	Bestell-Nr. Ordering-No.
3+PE	09-4224-00-04

Technische Daten
Specifications

Polzahl	3+PE	Number of contacts
Steckverbinder Verriegelung	Schrauben/screw	Connector locking system
Anschlussart	Schrauben/screw	Termination
Anschlussquerschnitt	0,5-2,5 mm ² (AWG 20-14)	Wire gauge
Kabeldurchlass	-	Cable outlet
Schutzart	IP67	Degree of protection
Mechanische Lebensdauer	> 500 Steckzyklen/> 500 mating cycles	Mechanical operation
Obere Grenztemperatur	+ 100 °C	Upper temperature
Untere Grenztemperatur	- 40 °C	Lower temperature
Bemessungsspannung	400 V (600 V UL)	Rated voltage
Bemessungs-Stoßspannung	6000 V	Rated impulse voltage
Verschmutzungsgrad	3	Pollution degree
Überspannungskategorie	III	Overvoltage categorie
Isolierstoffgruppe	III	Material group
Bemessungsstrom (40°C)	16 A (12 A UL)	Rated current (40 °C)
Durchgangswiderstand	≤ 5 mΩ	Contact resistance
Material Kontakt	CuZn (Messing/brass)	Material of contact
Kontaktfläche	Ag (Silber/silver)	Contact plating
Material Kontaktkörper	PBT	Material of contact body
Material Gehäuse	-	Material of housing

Leistungs Steckverbinder Serie 692 - 693
Power connectors series 692 - 693
Bezeichnung
Description
Flanschdose 6+PE, Lötanschluss
Female socket 6+PE, solder termination
Flanschdose 6+PE, Lötanschluss
VDE, SEV, UL Zulassung
Female socket 6+PE, solder termination
VDE, SEV, UL approval
Abbildung
Figure

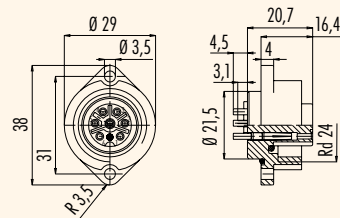
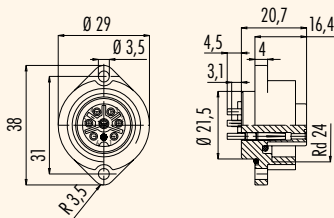
Maßzeichnung
Drawing

Bestell-Nr.
Ordering-No.

Polzahl Contacts	Bestell-Nr. Ordering-No.
6+PE	09-0216-00-07

Polzahl Contacts	Bestell-Nr. Ordering-No.
6+PE	09-4228-00-07

Technische Daten
Specifications

	6+PE	Number of contacts
Steckverbinder Verriegelung	Schrauben/screw	Connector locking system
Anschlussart	Löten/solder	Termination
Anschlussquerschnitt	max. 0,75 mm ² (max. AWG 20)	Wire gauge
Kabeldurchlass	-	Cable outlet
Schutzart	IP67	Degree of protection
Mechanische Lebensdauer	> 500 Steckzyklen/> 500 mating cycles	Mechanical operation
Obere Grenztemperatur	+ 100 °C	Upper temperature
Untere Grenztemperatur	- 40 °C	Lower temperature
Bemessungsspannung	250 V	Rated voltage
Bemessungs-Stoßspannung	4000 V	Rated impulse voltage
Verschmutzungsgrad	3	Pollution degree
Überspannungskategorie	III	Overvoltage categorie
Isolierstoffgruppe	III	Material group
Bemessungsstrom (40°C)	10 A (8 A UL)	Rated current (40 °C)
Durchgangswiderstand	≤ 5 mΩ	Contact resistance
Material Kontakt	CuSn (Bronze/bronze)	Material at contact
Kontaktoberfläche	Ag (Silber/silver)	Contact plating
Material Kontaktkörper	PBT	Material of contact body
Material Gehäuse	-	Material of housing

Leistungs Steckverbinder Serie 692 - 693
Power connectors series 692 - 693

Bezeichnung
Description

Flanschdose 6+PE, **Schraubanschluss**
Female socket 6+PE, **screw termination**

Abbildung
Figure



Flanschdose 6+PE, **Schraubanschluss**
VDE, SEV, UL Zulassung
Female socket 6+PE, **screw termination**
VDE, SEV, UL approval



Maßzeichnung
Drawing

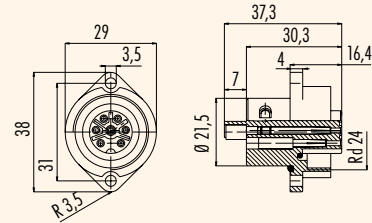
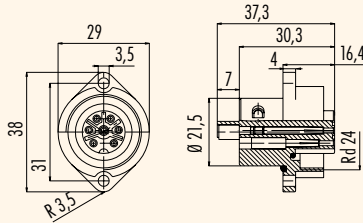

Bestell-Nr.
Ordering-No.

Polzahl Contacts	Bestell-Nr. Ordering-No.
6+PE	09-0220-00-07

Polzahl Contacts	Bestell-Nr. Ordering-No.
6+PE	09-4220-00-07

Technische Daten
Specifications

Polzahl	6+PE	Number of contacts
Steckverbinder Verriegelung	Schrauben/screw	Connector locking system
Anschlussart	Schrauben/screw	Termination
Anschlussquerschnitt	0,34-1,5 mm ² (AWG 22-16)	Wire gauge
Kabeldurchlass	-	Cable outlet
Schutzart	IP67	Degree of protection
Mechanische Lebensdauer	> 500 Steckzyklen/> 500 mating cycles	Mechanical operation
Obere Grenztemperatur	+ 100 °C	Upper temperature
Untere Grenztemperatur	- 40 °C	Lower temperature
Bemessungsspannung	250 V	Rated voltage
Bemessungs-Stoßspannung	4000 V	Rated impulse voltage
Verschmutzungsgrad	3	Pollution degree
Überspannungskategorie	III	Overvoltage categorie
Isolierstoffgruppe	III	Material group
Bemessungsstrom (40°C)	10 A (8 A UL)	Rated current (40 °C)
Durchgangswiderstand	≤ 5 mΩ	Contact resistance
Material Kontakt	CuSn (Bronze/bronze)	Material of contact
Kontaktoberfläche	Ag (Silber/silver)	Contact plating
Material Kontaktkörper	PBT	Material of contact body
Material Gehäuse	-	Material of housing

Leistungs Steckverbinder Serie 692 - 693
Power connectors series 692 - 693

Bezeichnung
Description

Abbildung
Figure

Flanschdose 6+PE, **Crimpschluss**
Female socket 6+PE, **crimp termination**

Crimpkontakte siehe Seite 27.
Crimp contacts see page 27.



Flanschdose 6+PE, **Crimpschluss**
VDE, SEV, UL Zulassung
Female socket 6+PE, **crimp termination**
VDE, SEV, UL approval

Crimpkontakte siehe Seite 27.
Crimp contacts see page 27.



Maßzeichnung
Drawing

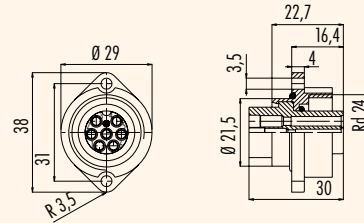
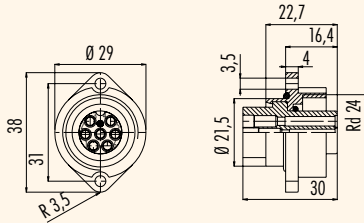

Bestell-Nr.
Ordering-No.

Polzahl Contacts	Bestell-Nr. Ordering-No.
6+PE	09-0204-00-07

Polzahl Contacts	Bestell-Nr. Ordering-No.
6+PE	09-4204-00-07

Technische Daten
Specifications

Polzahl	6+PE	Number of contacts
Steckverbinder Verriegelung	Schrauben/screw	Connector locking system
Anschlussart	crimpen/crimp	Termination
Anschlussquerschnitt	0,14-1,5 mm ² (AWG 26-16)	Wire gauge
Kabeldurchlass	-	Cable outlet
Schutzart	IP67	Degree of protection
Mechanische Lebensdauer	> 500 Steckzyklen/> 500 mating cycles	Mechanical operation
Obere Grenztemperatur	+ 100 °C	Upper temperature
Untere Grenztemperatur	- 40 °C	Lower temperature
Bemessungsspannung	250 V	Rated voltage
Bemessungs-Stoßspannung	4000 V	Rated impulse voltage
Verschmutzungsgrad	3	Pollution degree
Überspannungskategorie	III	Overvoltage categorie
Isolierstoffgruppe	III	Material group
Bemessungsstrom (40°C)	10 A (8 A UL)	Rated current (40 °C)
Durchgangswiderstand	-	Contact resistance
Material Kontakt	-	Material at contact
Kontaktoberfläche	-	Contact plating
Material Kontaktkörper	PBT	Material of contact body
Material Gehäuse	-	Material of housing

Leistungs Steckverbinder Serie 692 - 693
Power connectors series 692 - 693

Einzelteildarstellung
 Component part drawing

Kabelsteckverbinder
 Cable connectors

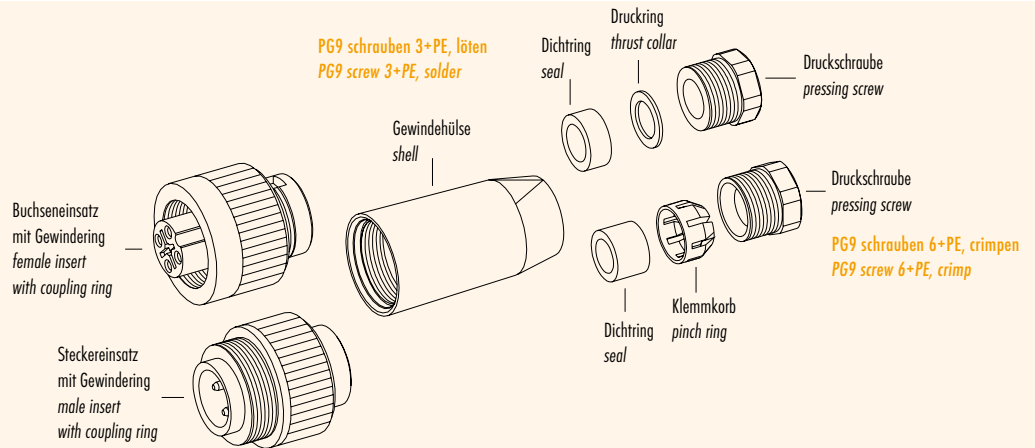

Kabelsteckverbinder mit Kabelzugentlastung PG9 Version UL, VDE, SEV (schrauben 3+PE, löten)
 Cable connectors with cable clamp PG9 version UL, VDE, SEV (screw 3+PE, solder)

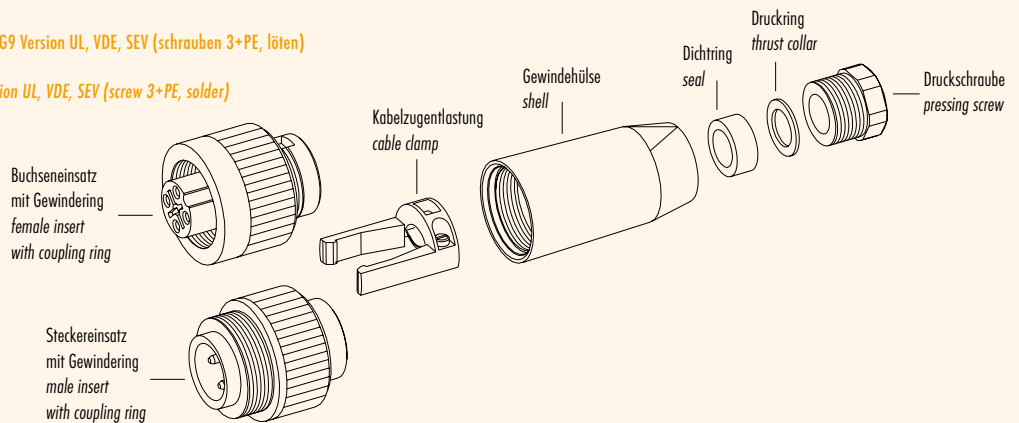

Kabelsteckverbinder mit Klemmkorb PG11-, PG13,5-, PG16 Version
 Cable connectors with pinch ring PG11-, PG13,5-, PG16 version

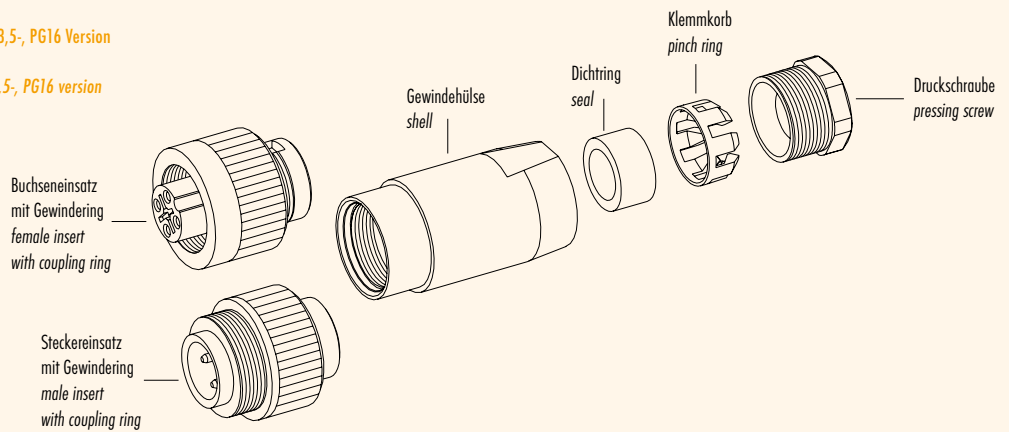

Winkelsteckverbinder
 Angled connectors

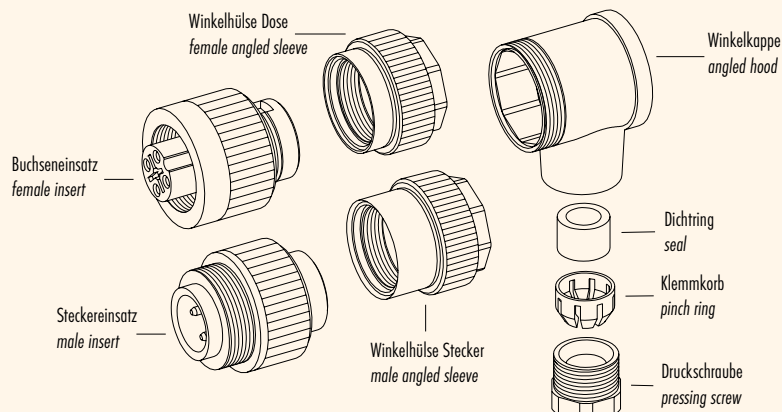

Leistungs Steckverbinder Serie 692 - 693
Power connectors series 692 - 693

Technische Daten Specifications of	Standard Kabel standard cable		
Polzahl	4	7	Contacts
Querschnitt mm ² ¹⁾	4 x 1,5 mm ²	4 x 0,75 mm ²	Wire gauge mm ² ¹⁾
Material Mantel	PVC schwarz / black		Material jacket
Isolation Litze	PVC (schwarz, grün/gelb / black, green/yellow)		Insulation wire
Litzenaufbau (mm)	28 x 0,25	24 x 0,20	Design of wire (mm)
Kabelmantel (mm)	8,6	9,7	Cable jacket (mm)
Leiterwiderstand	-		Resistance of wire
Temperaturbereich (Kabel bewegt)	- 5 °C / + 80 °C		Temperature range (cable in move)
Temperaturbereich (Kabel fest)	- 20 °C / + 80 °C		Temperature range (cable not in move)
Biegeradius (Kabel bewegt)	60 mm		Bending radius (cable in move)
Biegeradius (Kabel fest)	120 mm		Bending radius (cable not in move)
Zulassung	UL, CSA		Approval

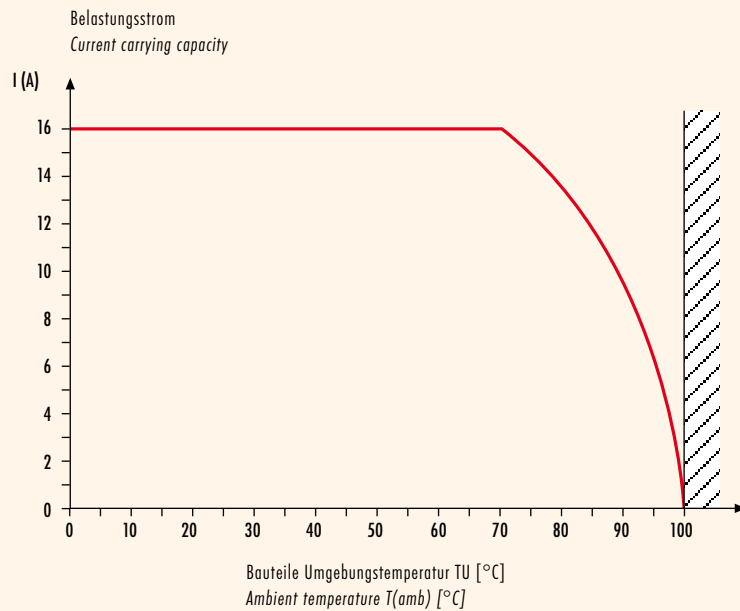
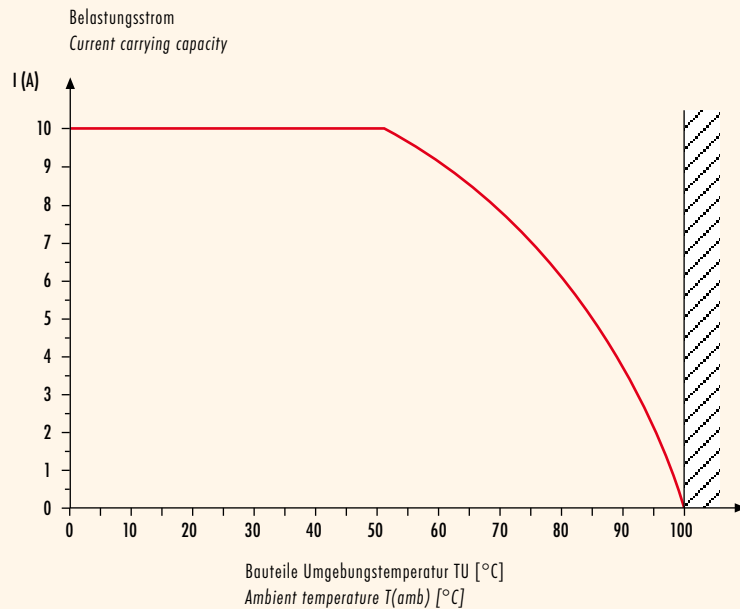
**Kennlinien
Ratings**
Strombelastbarkeitskurve 3+PE
Derating curve 3+PE

Strombelastbarkeitskurve 6+PE
Derating curve 6+PE

¹⁾ Vergleichbare AWG Leiter siehe Seite TI-5. / ¹⁾ Comparable AWG conductors see page TI-5.

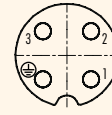
Leistungs Steckverbinder Serie 692 - 693
Power connectors series 692 - 693
Polbilder
Contact arrangements
Stifteinsatz (Steckseite)
Male insert (mating side)
Buchseinsatz (Steckseite)
Female insert (mating side)
3+PE pol
3+PE contacts

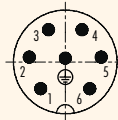

	X	Y
1	-3,18	-3,18
2	-3,18	3,18
3	3,18	3,18
PE	3,18	-3,18



	X	Y
1	3,18	-3,18
2	3,18	3,18
3	-3,18	3,18
PE	-3,18	-3,18

6+PE pol
6+PE contacts

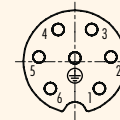
	X	Y
1	-3,25	-3,54
2	-4,76	0,63
3	-2,22	4,26
4	2,22	4,26
5	4,76	0,63
6	3,25	-3,54
PE	0,00	0,50

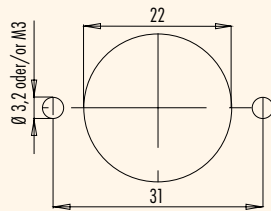

	X	Y
1	3,25	-3,54
2	4,76	0,63
3	2,22	4,26
4	-2,22	4,26
5	-4,76	0,63
6	-3,25	-3,54
PE	0,00	0,50

Montageausschnitt
Panel cut out

Leistungs Steckverbinder Serie 692 - 693 Power connectors series 692 - 693		Zubehör Accessories	
Bezeichnung Description	Schutzkappe für Kabelstecker, IP 67 Protection cap for male cable connector, IP 67	Schutzkappe für Flanschstecker, IP 67 Protection cap for male socket, IP 67	Schutzkappe für Flanschstecker, IP 67 Protection cap for male socket, IP 67
Abbildung Figure			
Maßzeichnung Drawing			
Bestell-Nr. Ordering-No.	Bestell-Nr. Ordering-No. 08-2299-000-000	Bestell-Nr. Ordering-No. 08-2672-000-000	Bestell-Nr. Ordering-No. 08-2301-000-000
Bezeichnung Description	Schutzkappe für Kabeldose, IP 67 Protection cap for female cable connector, IP 67	Schutzkappe für Flanschdose, IP 67 Protection cap for female socket, IP 67	Schutzkappe für Flanschdose, IP 67 Protection cap for female socket, IP 67
Abbildung Figure			
Maßzeichnung Drawing			
Bestell-Nr. Ordering-No.	Bestell-Nr. Ordering-No. 08-2300-000-000	Bestell-Nr. Ordering-No. 08-2673-000-000	Bestell-Nr. Ordering-No. 08-2302-000-000
Bezeichnung Description	Zugentlastung Cable clamp	Flachdichtung für Flanschsteckverbinder Flat seal for sockets	Anbaugehäuse Bulkhead housing
Abbildung Figure			
Maßzeichnung Drawing			
Bestell-Nr. Ordering-No.	Bestell-Nr. Ordering-No. 08-0628-000-000	Bestell-Nr. Ordering-No. 04-0722-000	Bestell-Nr. Ordering-No. 16-0566-00-00

Leistungs Steckverbinder Serie 692 - 693
Power connectors series 692 - 693

Zubehör
Accessories

Bezeichnung
Description

Schutzkappe für Anschlussseite, Flanschsteckverbinder mit Schraubanschluss
Protection cap - screw termination side for socket

Stiftkontakt (VE=100 Stck.)
Male contact (PU=100 pcs)

Buchsenkontakt (VE=100 Stck.)
Female contact (PU=100 pcs)

Abbildung
Figure

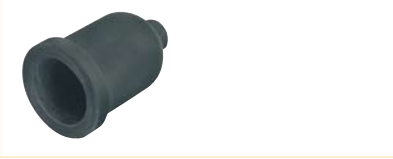

Maßzeichnung
Drawing

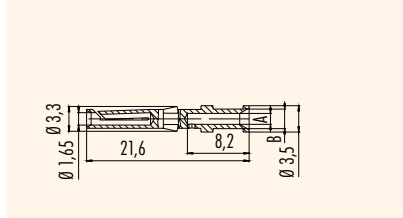
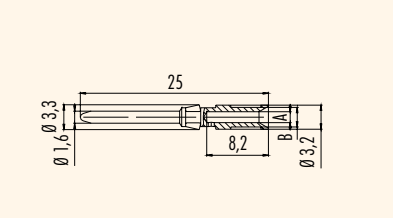
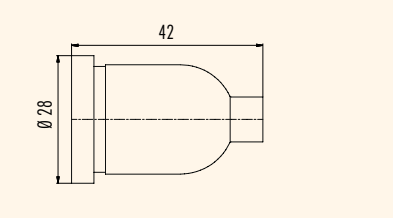

Bestell-Nr.
Ordering-No.

Bestell-Nr. Ordering-No.	16-0565-00-00
-----------------------------	---------------

A	B	Für Leiterquerschnitt for wire gauge	AWG	Bestell-Nr. Ordering-No.
0,9	2,6	0,14-0,34 mm ²	26-22	61-0891-139
1,1	2,6	0,5 mm ²	20	61-0892-139
1,45	2,6	0,75-1 mm ²	18	61-0893-139
1,8	3,0	1,5 mm ²	16	61-0894-139

A	B	Für Leiterquerschnitt for wire gauge	AWG	Bestell-Nr. Ordering-No.
0,9	2,6	0,14-0,34 mm ²	26-22	61-0896-139
1,1	2,6	0,5 mm ²	20	61-0897-139
1,45	2,6	0,75-1 mm ²	18	61-0898-139
1,8	3,0	1,5 mm ²	16	61-0899-139

Bezeichnung
Description

Crimpzange für gedrehte Crimpkontakte
Hand crimping tool for turned crimp contacts

Lösewerkzeug für Kontakte
Removal tool for contacts

Abbildung
Figure



Bestell-Nr.
Ordering-No.

Bestell-Nr. Ordering-No.	66-0003-001
-----------------------------	-------------

Bestell-Nr. Ordering-No.	66-0004-001
-----------------------------	-------------

Technische Daten Kontakte
Specifications of contacts

Durchgangswiderstand	≤ 5 mΩ	Contact resistance
Material Kontakt	CuSn (Bronze/bronze)	Material of contact
Kontaktoberfläche	Ag (Silber/silver)	Contact plating

Leistungs Steckverbinder Serie 692 - 693
Power connectors series 692 - 693

Notizen
Notes

Large blank area for notes, consisting of a grid of horizontal lines on a light beige background.

- ü
- TI
- SIP40
- SIP67
- Bejonett
- MPP/67
- PP/67
- M9/40
- M9/67
- SIP67
- Bejonett
- PP/67
- M16/40
- M16/67
- M23
- Bejonett
- M25
- RD24
- RD30
- M5
- M8
- M12-A
- VL
- Verteiler
- M12-B
- M12-D
- M12-US
- M18
- 7/8"
- BF-A
- BF-B
- BF-C
- R